



**GaAs MMIC SP8T NON-REFLECTIVE  
SWITCH, DC - 3.5 GHz**

**Typical Applications**

The HMC253LC4 is ideal for:

- Basestations & Repeaters
- WiMAX/WiBro & Fixed Wireless
- Cellular/3G Infrastructure
- CATV/DBS
- Military & Hi-Rel

**Features**

- Ceramic, RoHS Compliant 4x4mm SMT Package
- Non-Reflective Topology
- Low Insertion Loss: 1.2 dB
- Single Positive Supply:  $V_{dd} = +5V$
- Integrated 3:8 TTL/CMOS Decoder: 0/+3V

**Functional Diagram**

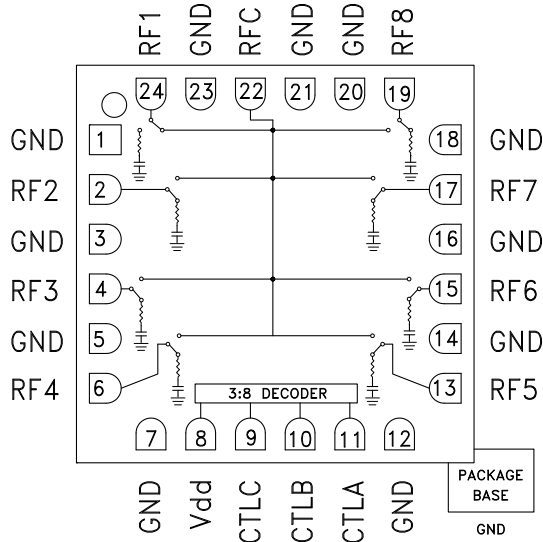

**General Description**

The HMC253LC4 is a non-reflective SP8T switch in a leadless RoHS compliant 4x4 mm ceramic SMT package featuring wideband operation from DC to 3.5 GHz. The switch offers a single positive bias and true TTL/CMOS compatibility enabling it to operate with 0/+3V control and a +5V supply. A 3:8 decoder is integrated on the switch requiring only 3 control lines and a positive bias to select each path. The HMC253LC4 SP8T will replace multiple configurations of SP4T and SPDT MMIC switches.

**Electrical Specifications,**

$T_A = +25^\circ C$ , For TTL Control and  $V_{dd} = +5V$  in a 50 Ohm system

Parameter	Frequency	Min.	Typ.	Max.	Units
Insertion Loss	DC - 2.0 GHz		1.1	1.5	dB
	DC - 3.0 GHz		1.2	1.6	dB
	DC - 3.5 GHz		1.3	1.7	dB
Isolation	DC - 2.0 GHz	35	40		dB
	DC - 3.0 GHz	31	36		dB
	DC - 3.5 GHz	30	35		dB
Return Loss	"On State"	0.3 - 3.0 GHz	15	18	dB
		0.3 - 3.5 GHz	12	14	dB
Return Loss (RF1-8)	"Off State"	0.3 - 3.5 GHz	7	10	dB
		0.5 - 3.5 GHz	10	14	dB
Input Power for 1 dB Compression	0.5 - 3.5 GHz	20	24		dBm
Input Third Order Intercept (Two-Tone Input Power = +7 dBm Each Tone)	0.5 - 3.5 GHz	40	43		dBm
Switching Characteristics	0.3 - 3.5 GHz				
		tRISE, tFALL (10/90% RF)		30	
tON, tOFF (50% CTL to 10/90% RF)			100		ns

Information furnished by Analog Devices is believed to be accurate and reliable. However, no responsibility is assumed by Analog Devices for its use, nor for any infringements of patents or other rights of third parties that may result from its use. Specifications subject to change without notice. No license is granted by implication or otherwise under any patent or patent rights of Analog Devices. Trademarks and registered trademarks are the property of their respective owners.

For price, delivery, and to place orders: Analog Devices, Inc., One Technology Way, P.O. Box 9106, Norwood, MA 02062-9106 Phone: 781-329-4700 • Order online at [www.analog.com](http://www.analog.com) Application Support: Phone: 1-800-ANALOG-D



**GaAs MMIC SP8T NON-REFLECTIVE  
SWITCH, DC - 3.5 GHz**

**Insertion Loss**

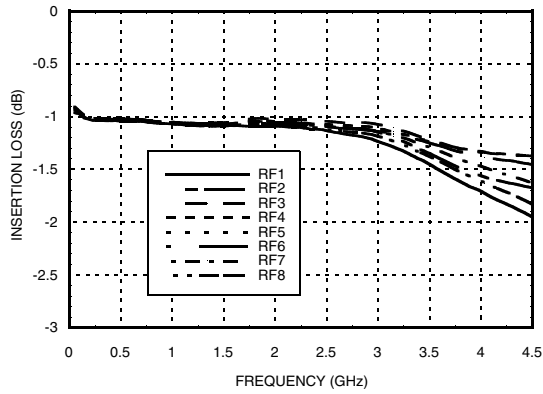

**Insertion Loss vs. Temperature**

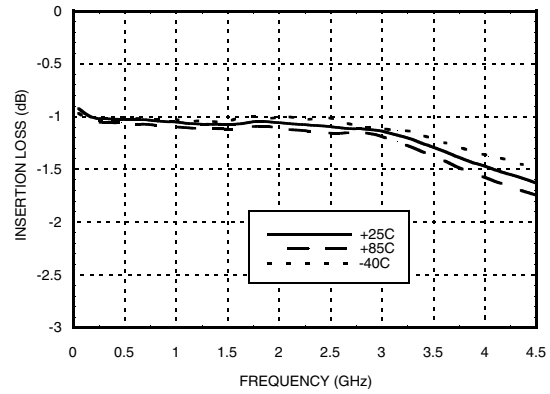

**Return Loss**

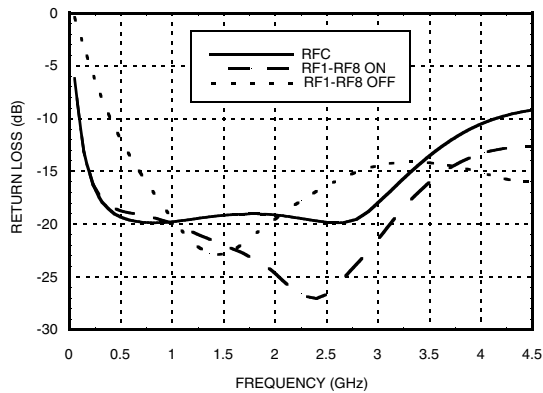

**Isolation**

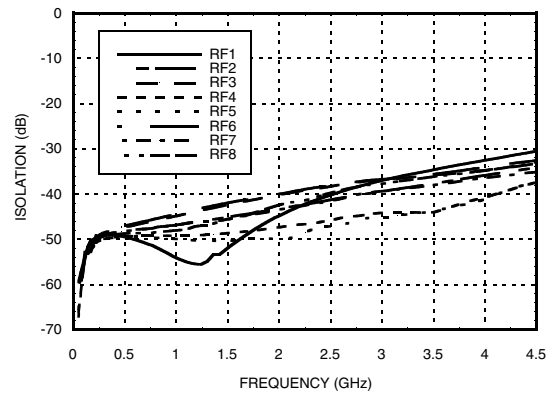

**Input IP3**

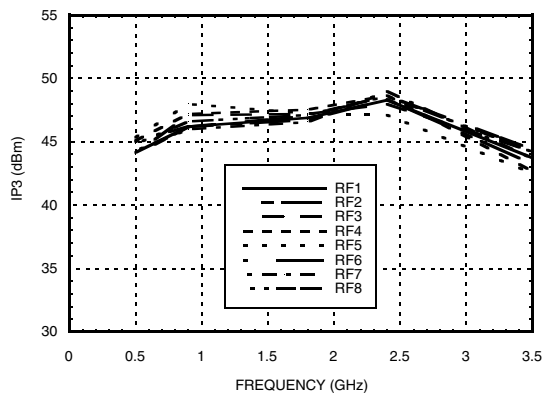

**Input Compression**

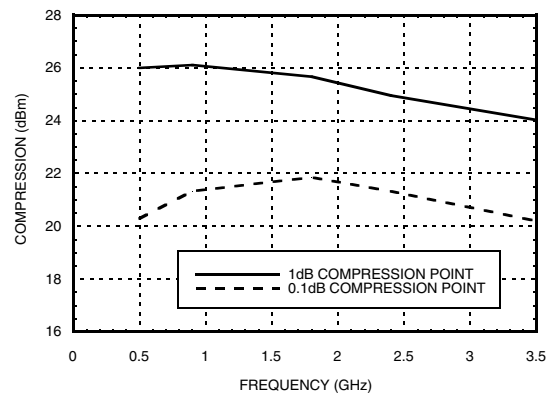

Information furnished by Analog Devices is believed to be accurate and reliable. However, no responsibility is assumed by Analog Devices for its use, nor for any infringements of patents or other rights of third parties that may result from its use. Specifications subject to change without notice. No license is granted by implication or otherwise under any patent or patent rights of Analog Devices. Trademarks and registered trademarks are the property of their respective owners.

For price, delivery, and to place orders: Analog Devices, Inc., One Technology Way, P.O. Box 9106, Norwood, MA 02062-9106 Phone: 781-329-4700 • Order online at [www.analog.com](http://www.analog.com) Application Support: Phone: 1-800-ANALOG-D



## GaAs MMIC SP8T NON-REFLECTIVE SWITCH, DC - 3.5 GHz

### Bias Voltage & Current

Vdd Range = +5 Vdc ± 10%		
Vdd (Vdc)	Idd (Typ.) (mA)	Idd (Max.) (mA)
+5	6.0	9.0

### TTL/CMOS Control Voltages

State	Bias Condition
Low	0 to +0.8 Vdc @ 5 µA Typ.
High	+2.0 to +5 Vdc @ 70 µA Typ.

**NOTE:**

DC Blocking capacitors are required at ports RFC and RF1, 2, 3, 4, 5, 6, 7, 8.

### Truth Table

Control Input			Signal Path State
A	B	C	RFCOM to:
Low	Low	Low	RF1
High	Low	Low	RF2
Low	High	Low	RF3
High	High	Low	RF4
Low	Low	High	RF5
High	Low	High	RF6
Low	High	High	RF7
High	High	High	RF8

### Absolute Maximum Ratings

Bias Voltage Range (Port Vdd)	+7.0 Vdc
Control Voltage Range (A, B, C)	-0.5V to Vdd +1Vdc
Channel Temperature	150 °C
Storage Temperature	-65 to +150 °C
Operating Temperature	-40 to +85 °C
Maximum Input Power Vdd = +5V	+20 dBm (0.05 - 0.5 GHz) +25 dBm (0.5 - 3.5 GHz)



**ELECTROSTATIC SENSITIVE DEVICE  
OBSERVE HANDLING PRECAUTIONS**



## GaAs MMIC SP8T NON-REFLECTIVE SWITCH, DC - 3.5 GHz

### Outline Drawing

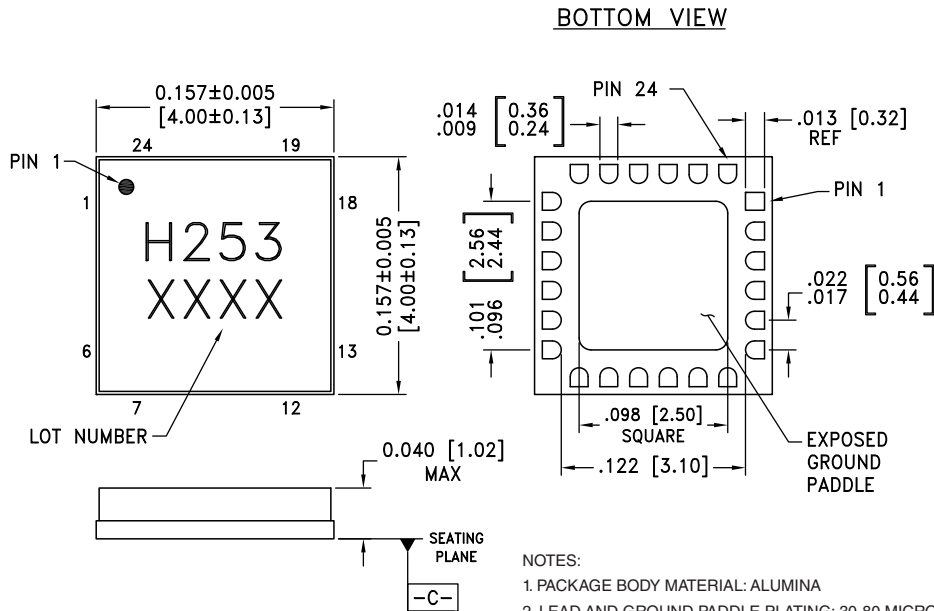

**NOTES:**

1. PACKAGE BODY MATERIAL: ALUMINA
2. LEAD AND GROUND PADDLE PLATING: 30-80 MICROINCHES GOLD OVER 50 MICROINCHES MINIMUM NICKEL.
3. DIMENSIONS ARE IN INCHES [MILLIMETERS].
4. LEAD SPACING TOLERANCE IS NON-CUMULATIVE.
5. PACKAGE WARP SHALL NOT EXCEED 0.05mm DATUM -C-
6. ALL GROUND LEADS AND GROUND PADDLE MUST BE SOLDERED TO PCB RF GROUND.

### Package Information

Part Number	Package Body Material	Lead Finish	MSL Rating	Package Marking <sup>[2]</sup>
HMC253LC4	Alumina, White	Gold over Nickel	MSL3 <sup>[1]</sup>	H253 XXXX

[1] Max peak reflow temperature of 260 °C

[2] 4-Digit lot number XXXX



## GaAs MMIC SP8T NON-REFLECTIVE SWITCH, DC - 3.5 GHz

### Pin Descriptions

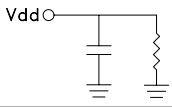
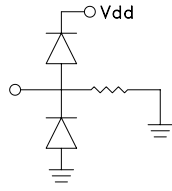
Pin Number	Function	Description	Interface Schematic
1, 3, 5, 7, 12, 14, 16, 18, 20, 21, 23	GND	Package bottom has exposed metal paddle that must also be connected to RF ground.	
2, 4, 6, 13, 15, 17, 19, 22, 24	RF1 - RF8 & RFC	This pin is DC coupled and matched to 50 Ohms. Blocking capacitors are required.	
8	Vdd	Supply Voltage +5 Vdc ±10%	
9	CTL C	See truth table and control voltage table.	
10	CTL B		
11	CTL A		



## GaAs MMIC SP8T NON-REFLECTIVE SWITCH, DC - 3.5 GHz

### Evaluation Circuit Board

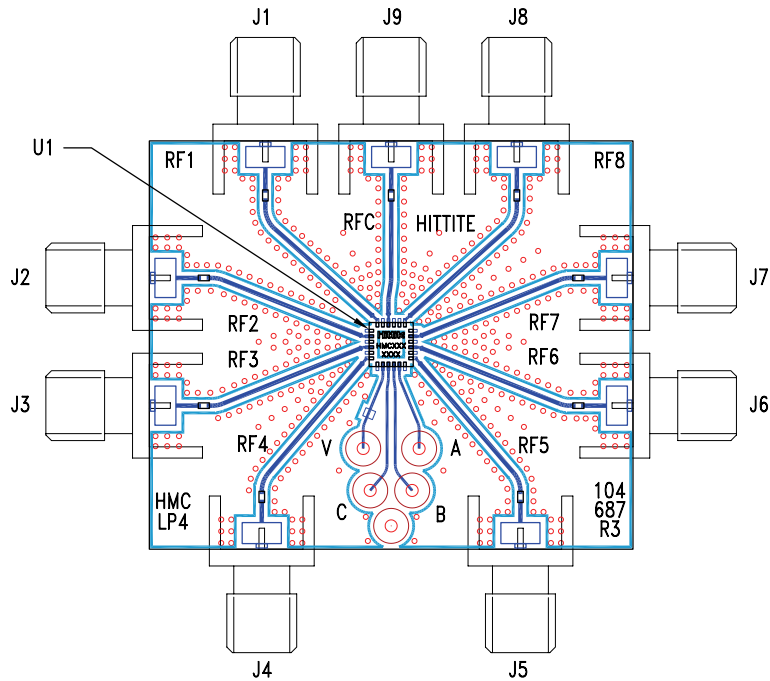

### List of Materials for Evaluation PCB 107780 [1]

Item	Description
J1 - J9	PCB Mount SMA Connector
J10 - J14	DC Pin
C1 - C9	100 pF Capacitor, 0402 Pkg.
C10	0.01 uF Capacitor, 0603 Pkg.
U1	HMC253LC4 SP8T Switch
PCB [2]	104687 Eval Board

[1] Reference this number when ordering complete evaluation PCB

[2] Circuit Board Material: Rogers 4350

The circuit board used in the application should be generated with proper RF circuit design techniques. Signal lines at the RF ports should have 50 ohm impedance while the package ground leads should be connected directly to the ground plane similar to that shown above. A sufficient number of via holes should be used to connect the top and bottom ground planes. The evaluation circuit board shown above is available from Hittite Microwave Corporation upon request.