

ASMT-QxBD-Axxxx

Super 0.5W Power PLCC-4 Surface Mount LED Indicator



Overview

The Super 0.5W Power PLCC-4 SMT LEDs are an extension of the Power PLCC-4 SMT LEDs. The package can be driven at high current due to its superior package design. The product is able to dissipate the heat more efficiently compared to the Power PLCC-4 SMT LEDs. These LEDs also produce higher light output with better flux performance compared to the Power PLCC-4 SMT LEDs.

The Super 0.5W Power PLCC-4 SMT LEDs are designed for higher reliability, better performance, and operate under a wide range of environmental conditions. The performance characteristics of these new mid-power LEDs make them uniquely suitable for use in harsh conditions such as in automotive applications and in electronics signs and signals.

To facilitate easy pick and place assembly, the LEDs are packed in EIA-compliant tape and reel. Every reel is shipped in single intensity and color bin (except for red), to provide close uniformity.

Super 0.5W Power PLCC-4 SMT LEDs are available in red and amber colors.

Features

- Industry Standard PLCC 4 platform (3.2 mm × 2.8 mm × 1.9 mm)
- High-reliability package with enhanced silicone resin encapsulation
- High-intensity brightness with optimum flux performance using AlInGaP chip technologies
- Available in Red and Amber colors
- High optical efficiency
- Available in 8 mm carrier tape and 7-inch reel
- Low thermal resistance 60°C/W
- Super-wide viewing angle at 120°
- Longer lifetime with minimum degradation due to enhanced Silicone resin material
- JEDEC MSL 2

Applications

- Exterior automotive:
 - Turn signals
 - Side repeaters
 - CHSML
 - Rear combination lamp
 - Side markers
 - Truck clearance lamp
- Electronic signs and signals:
 - Channel lettering
 - Contour lighting
 - Indoor variable message sign
- Office automation, home appliances, industrial equipment:
 - Front-panel backlighting
 - Push-button backlighting
 - Display backlighting

Package Drawing

Figure 1: Package Drawing

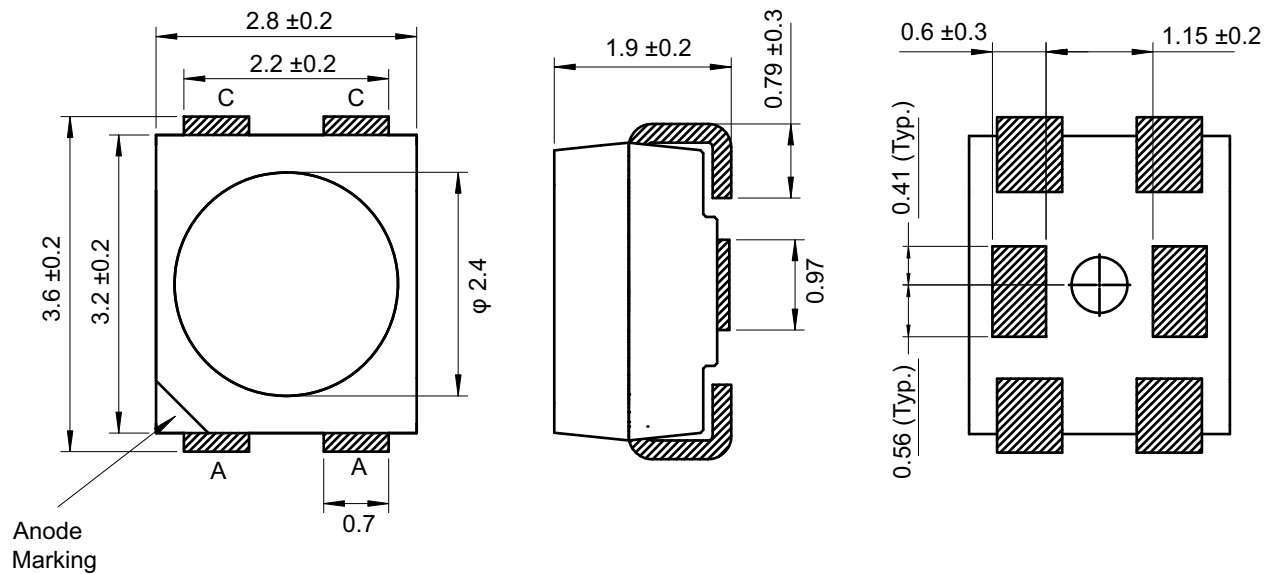

NOTE:

- All dimensions in millimeters.
- Lead polarity as shown in [Figure 14](#).
- Terminal Finish: Ag plating
- Encapsulation material: Silicone resin

Device Selection Guide

Color	Part Number	Luminous Flux, ϕ_V (lm) ^{a b}				Dice Technology
		Min. Flux (lm)	Typ. Flux (lm)	Max. Flux (lm)	Test Current (mA)	
Amber	ASMT-QABD-AEF0E	11.5	16.5	19.5	150	AllnGaP
Amber	ASMT-QABD-AEFJE	11.5	—	19.5	150	AllnGaP
Red Orange	ASMT-QHBD-AEFBE	11.5	—	19.5	150	AllnGaP
Red Orange	ASMT-QHBD-AFH0E	15.0	17.5	33.0	150	AllnGaP
Red Orange	ASMT-QHBD-AFG0E	15.0	—	25.5	150	AllnGaP
Red	ASMT-QRBD-AEF0E	11.5	16.5	19.5	150	AllnGaP

a. ϕ_V is the total luminous flux output as measured with an integrating sphere at mono pulse condition.

b. Flux tolerance is $\pm 12\%$

Part Numbering System

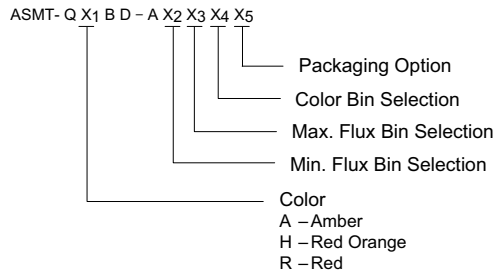

Absolute Maximum Ratings ($T_A = 25^\circ\text{C}$)

Parameters	ASMT-QxBD-Axxxx
DC Forward Current ^a	150 mA
Peak Forward Current ^b	300 mA
Power Dissipation	450 mW
Reverse Voltage, V_R , at 100 mA	5V
Junction Temperature	125°C
Operating Temperature	-40°C to +120°C
Storage Temperature	-40°C to +120°C

a. Derate Linearly as shown in [Figure 6](#).

b. Duty Factor = 10%, Frequency = 1 kHz

Optical Characteristics ($T_J = 25^\circ\text{C}$)

Color	Part Number	Dice Technology	Peak Wavelength λ_{PEAK} (nm)	Dominant Wavelength λ_D (nm) ^a	Viewing Angle $2\theta_{1/2}$ (Degrees) ^b	Luminous Efficiency η_e (lm/W)	Total Flux/ Luminous Intensity ϕ_V (lm)/ I_V (cd)
			Typ.	Typ.	Typ.	Typ.	Typ.
Amber	ASMT-QABD-Axx0E	AllnGaP	596.2	593.1	120	44	2.5
Red Orange	ASMT-QHBD-Axx0E	AllnGaP	624.1	616.1	120	47	2.5
Red	ASMT-QRBD-Axx0E	AllnGaP	629.7	621.1	120	44	2.5

a. The dominant wavelength, λ_D , is derived from the CIE Chromaticity diagram and represents the color of the device.

b. $\theta_{1/2}$ is the off-axis angle where the luminous intensity is $1/2$ the peak intensity.

Electrical Characteristics ($T_J = 25^\circ\text{C}$)

Part Number	Forward Voltage V_F (V) at $I_F = 150$ mA			Thermal Resistance, $R_{\theta_{J-P}}$ ($^\circ\text{C}/\text{W}$)
	Min.	Typ.	Max.	
ASMT-QABD-AxxxE	2.05	2.30	2.95	60
ASMT-QHBD-AxxxE	2.05	2.50	2.95	60
ASMT-QRBD-AxxxE	2.05	2.50	2.95	60

Figure 2: Relative Intensity vs. Wavelength

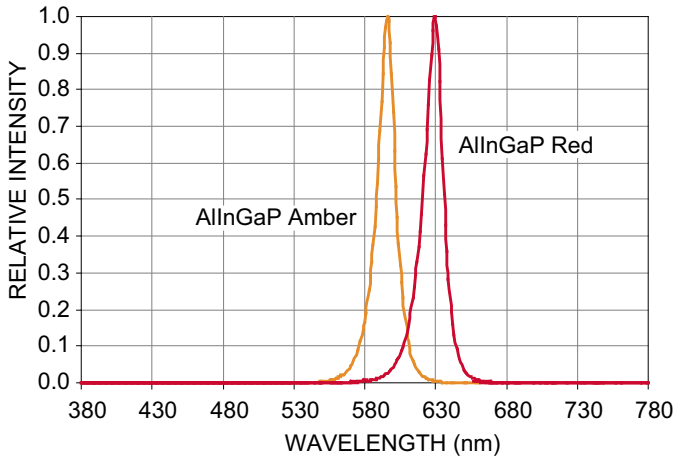

Figure 3: Forward Current vs. Forward Voltage.

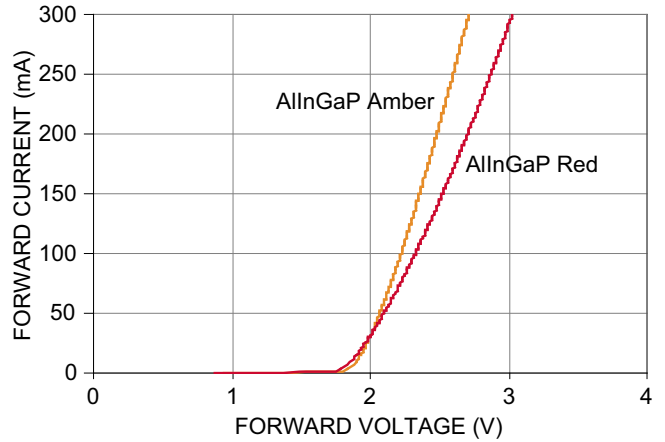

Figure 4: Relative Intensity vs. Forward Current

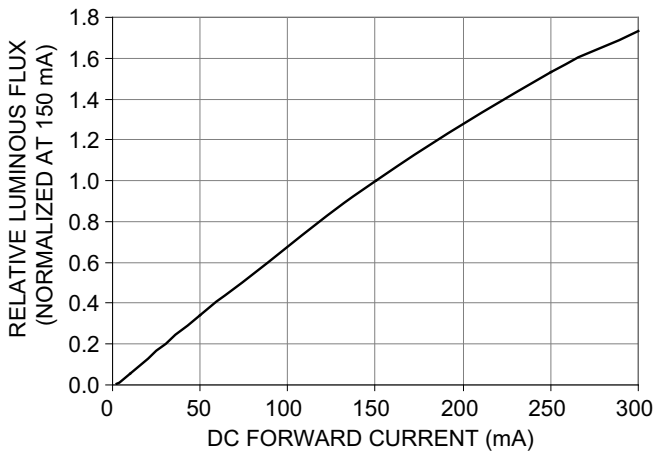

Figure 5: Relative Intensity vs. Temperature

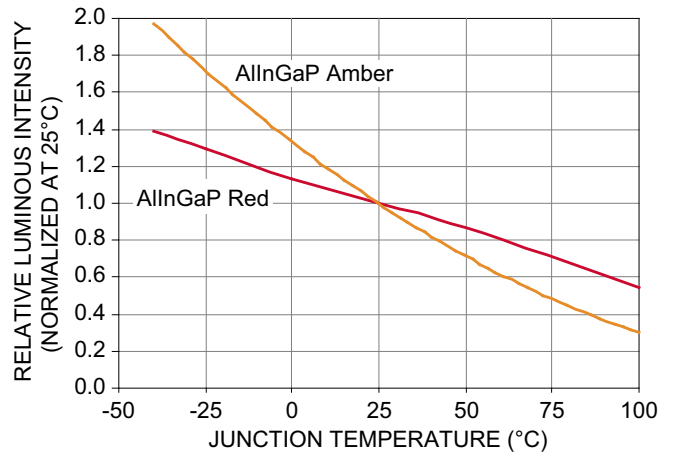

Figure 6: Max. Forward Current vs. Ambient Temperature Derated Based on $T_{JMAX} = 125^{\circ}C$, $R_{\theta J-A} = 130^{\circ}C/W$, $110^{\circ}C/W$, and $100^{\circ}C/W$.

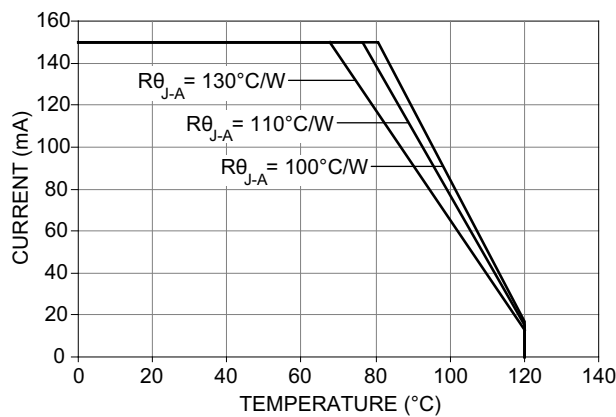

Figure 7: Max. Forward Current vs. Solder Point Temperature Derated Based on $T_{JMAX} = 125^{\circ}C$, $R_{\theta J-P} = 60^{\circ}C/W$.

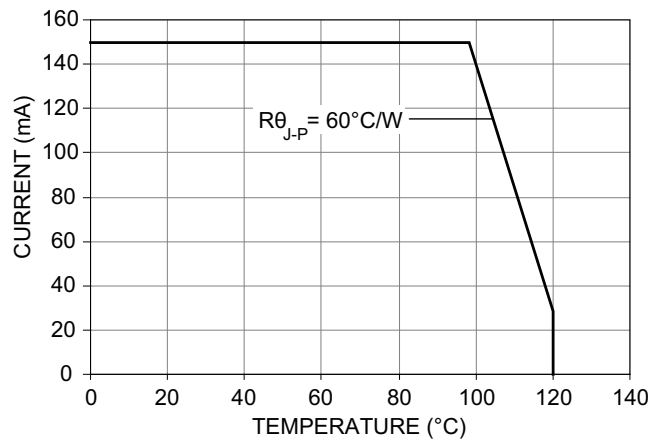

Figure 8: Max. Pulse Current vs. Ambient Temperature Derated Based on $T_A = 25^\circ\text{C}$, $R\theta_{J-A} = 110^\circ\text{C/W}$

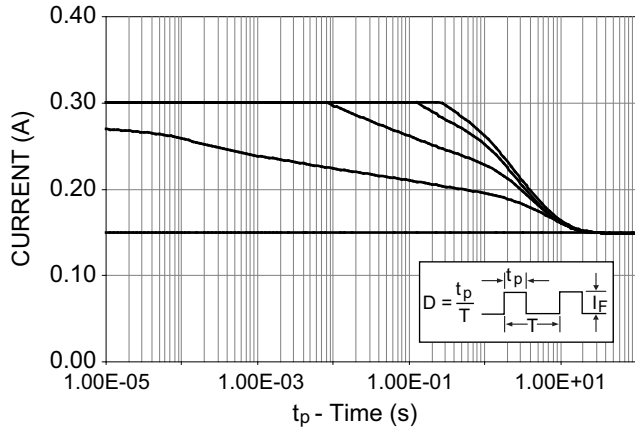

Figure 9: Max. Pulse Current vs. Ambient Temperature Derated Based on $T_A = 85^\circ\text{C}$, $R\theta_{J-A} = 110^\circ\text{C/W}$

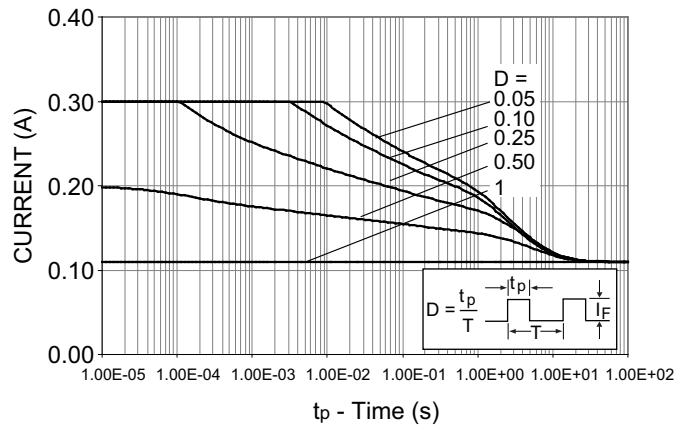

Figure 10: Dominant Wavelength vs. Forward Current (AlInGaP Devices)

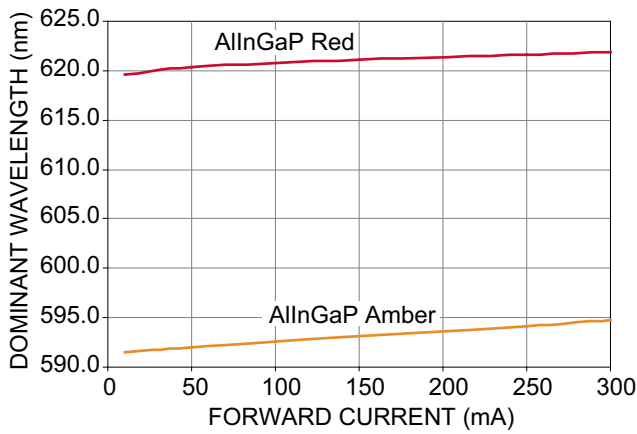

Figure 11: Forward Voltage Shift vs. Temperature

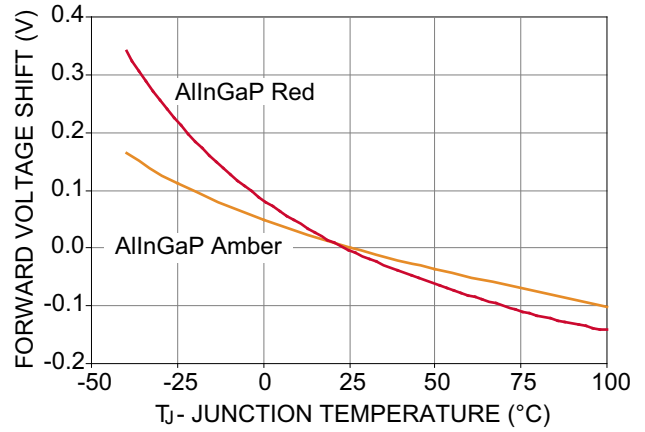

Figure 12: Radiation Pattern

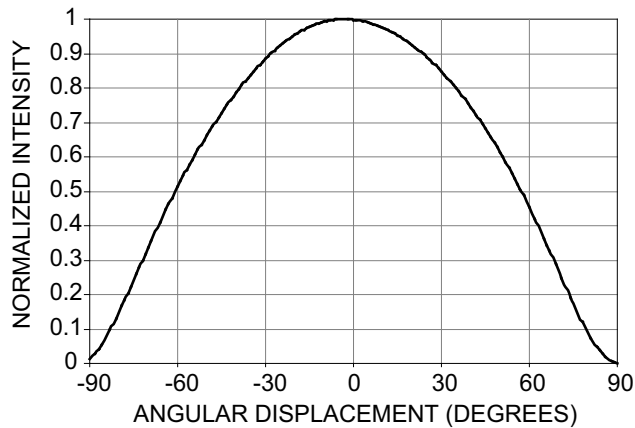

Figure 13: Recommended Pb-free Reflow Soldering Profile

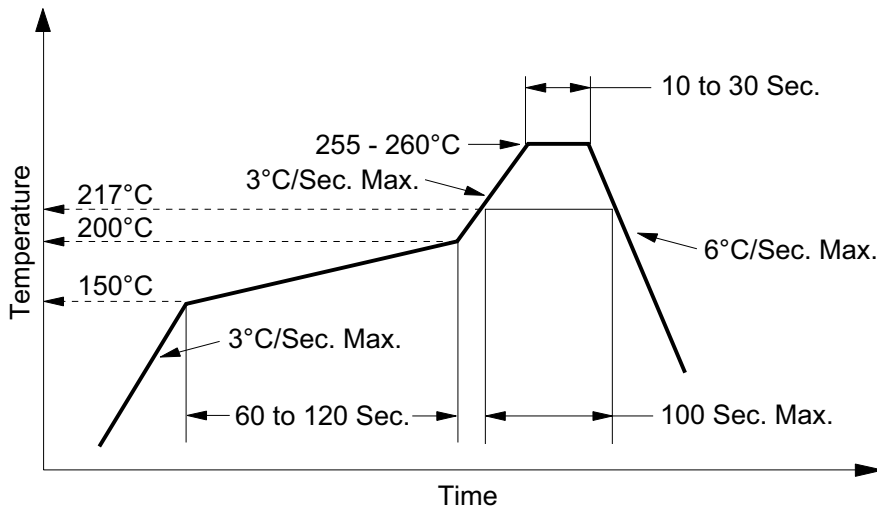

Figure 14: Recommended Soldering Pad Pattern

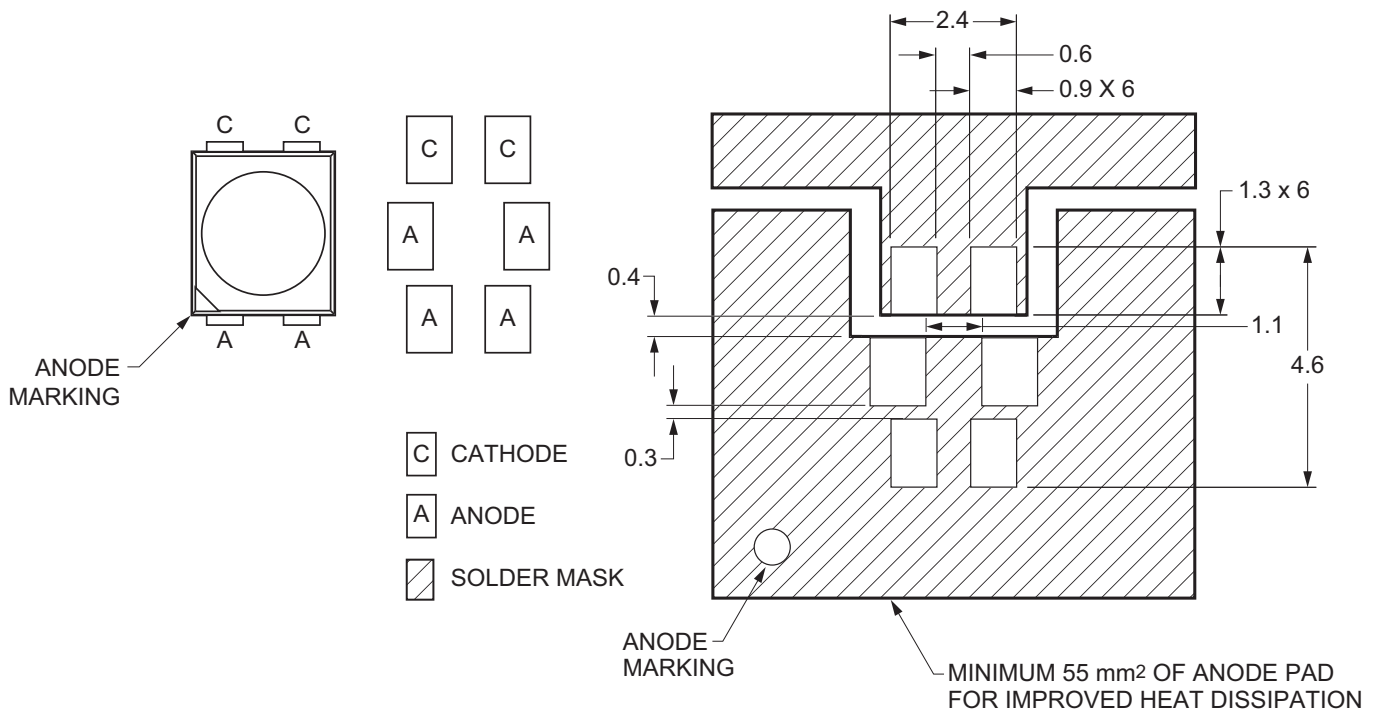

Figure 15: Tape Leader and Trailer Dimensions

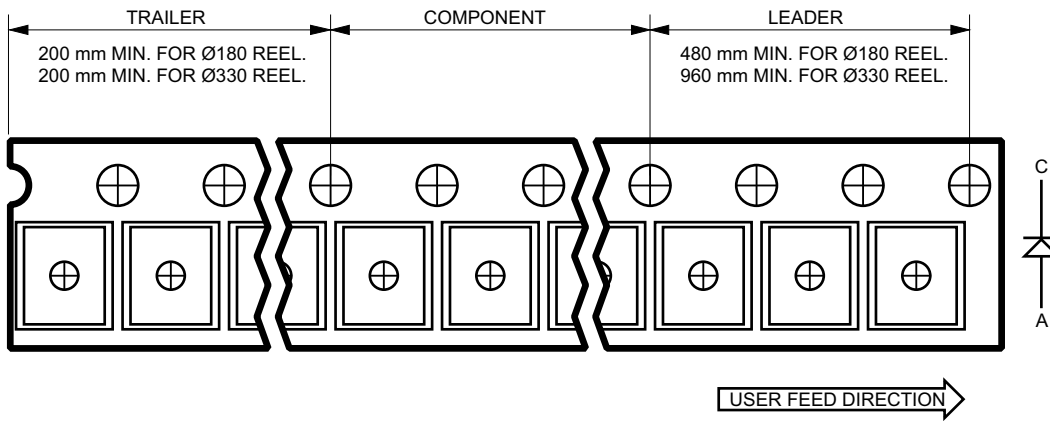

Figure 16: Tape Dimensions

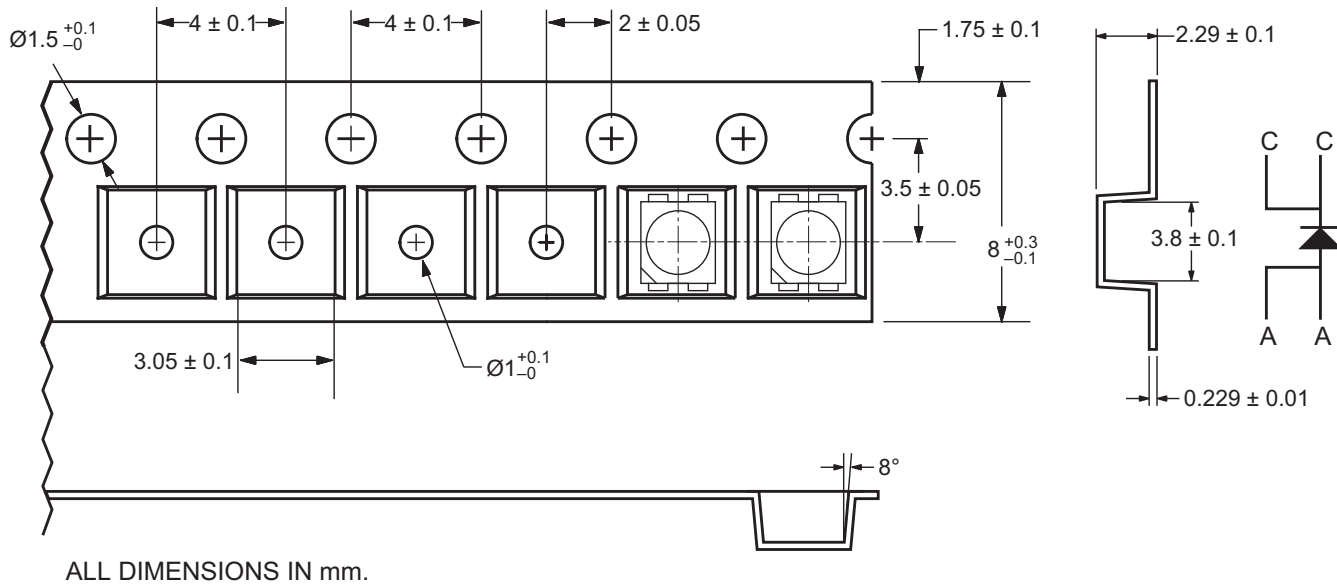
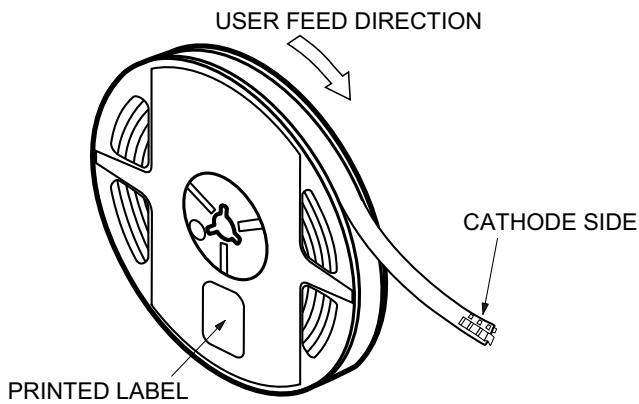

Figure 17: Reeling Orientation



Device Color (X₁)

A	Amber
H	Red Orange
R	Red

Flux Bin Select (X₂X₃)

Individual reel will contain parts from one bin only.

X ₂	Min Flux Bin
X ₃	Max Flux Bin

Flux Bin Limits

Bin ID	Min. (lm)	Max. (lm)
0	3.30	4.30
A	4.30	5.50
B	5.50	7.00
C	7.00	9.00
D	9.00	11.50
E	11.50	15.00
F	15.00	19.50
G	19.50	25.50
H	25.50	33.00
J	33.00	43.00
K	43.00	56.00
L	56.00	73.00

Tolerance of each bin limit = ± 12%

Color Bin Select (X₄)

Individual reel will contain parts from one full bin only.

X ₄	
0	Full Distribution
A	1 and 2 only
B	2 and 3 only
C	3 and 4 only
D	4 and 5 only
E	5 and 6 only
G	1, 2, and 3 only
H	2, 3, and 4 only
J	3, 4, and 5 only
K	4, 5, and 6 only
M	1, 2, 3, and 4 only
N	2, 3, 4, and 5 only
P	3, 4, 5, and 6 only
R	1, 2, 3, 4, and 5 only
S	2, 3, 4, 5, and 6 only
Z	Special Color Bin

Color Bin Limits

Amber/Yellow	Min. (nm)	Max. (nm)
2	583.0	586.0
3	586.0	589.0
4	589.0	592.0
5	592.0	595.0
6	595.0	598.0

Red Orange	Min. (nm)	Max. (nm)
1	611.0	616.0
2	616.0	620.0
3	620.0	625.0

Red	Min. (nm)	Max. (nm)
Full Distribution	620.0	635.0

Tolerance of each bin limit = ± 1 nm

VF Binning

Bin	Min.	Max.
2B	2.05	2.20
2C	2.20	2.35
2D	2.35	2.50
2E	2.50	2.65
2F	2.65	2.80
2G	2.80	2.95

Tolerance of each bin = ± 0.1 V

Packaging Option (X₅)

Option	Test Current	Package Type	Reel Size
E	150 mA	Top Mount	7 inch

Precautionary Notes

Handling Precautions

The encapsulation material of the LED is made of silicone for better product reliability. Compared to epoxy encapsulant that is hard and brittle, silicone is softer and flexible. Special handling precautions must be observed during the assembly of silicone encapsulated LED products. Failure to comply may lead to damage and premature failure of the LED. Refer to Application Note AN5288, *Silicone Encapsulation for LED: Advantages and Handling Precautions*, for more information.

- Do not poke sharp objects into the silicone encapsulant. Sharp objects, such as tweezers or syringes, might apply excessive force or even pierce through the silicone and induce failures to the LED die or wire bond.
- Do not touch the silicone encapsulant. Uncontrolled force acting on the silicone encapsulant might result in excessive stress on the wire bond. Hold the LED only by the body.
- Do not stack assembled PCBs together. Use an appropriate rack to hold the PCBs.
- The surface of the silicone material attracts dust and dirt easier than epoxy due to its surface tackiness. To remove foreign particles on the surface of silicone, use a cotton bud with isopropyl alcohol (IPA). During cleaning, rub the surface gently without putting much pressure on the silicone. Ultrasonic cleaning is not recommended.
- For automated pick and place, Broadcom has tested the following nozzle size to work with this LED. However, due to the possibility of variations in other parameters, such as pick and place, machine maker/model, and other settings of the machine, verify that the selected nozzle will not cause damage to the LED.

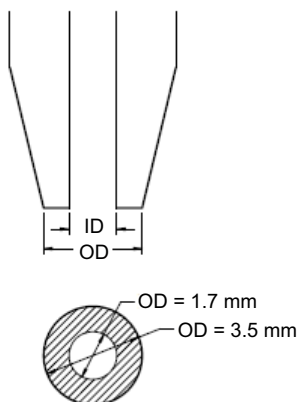

Handling of Moisture-Sensitive Device

This product has a Moisture Sensitive Level 2 rating per JEDEC J-STD-020. Refer to Application Note AN5305, *Handling of Moisture Sensitive Surface Mount Devices*, for additional details and a review of proper handling procedures.

- Before use:
 - An unopened moisture barrier bag (MBB) can be stored at $<40^{\circ}\text{C}/90\% \text{RH}$ for 12 months. If the actual shelf life has exceeded 12 months and the humidity indicator card (HIC) indicates that baking is not required, then it is safe to reflow the LEDs per the original MSL rating.
 - Do not open the MBB prior to assembly (for IQC, as an example).
- Control after opening the MBB:
 - Read the HIC immediately upon opening of the MBB.
 - Keep the LEDs at $<30^{\circ}\text{C}/60\% \text{RH}$ at all times. All high temperature-related processes, including soldering, curing, or rework, must be completed within 1 year.
- Control for unfinished reel:

Store unused LEDs in a sealed MBB with desiccant or desiccator at $<5\% \text{RH}$.
- Control of assembled boards:

If the PCB soldered with the LEDs will be subjected to other high-temperature processes, the PCB must be stored in a sealed MBB with desiccant or desiccator at $<5\% \text{RH}$ to ensure that all LEDs have not exceeded their floor life of 1 year.
- Baking is required if:
 - The HIC indicator is not BROWN at 10% and is AZURE at 5%.
 - The LEDs are exposed to conditions of $>30^{\circ}\text{C}/60\% \text{RH}$ at any time.
 - The LED floor life exceeded 168 hrs.

The recommended baking condition is: $60^{\circ}\text{C} \pm 5^{\circ}\text{C}$ for 20 hrs.

Baking should only be done once.
- Storage:

The soldering terminals of these Broadcom LEDs are silver plated. If the LEDs are exposed in ambient environment for too long, the silver plating might become oxidized, which affects its solderability performance. As such, keep unused LEDs in a sealed MBB with desiccant or in desiccator at $<5\% \text{RH}$.

Application Precautions

- The drive current of the LED must not exceed the maximum allowable limit across temperature as stated in the data sheet. Constant current driving is recommended to ensure consistent performance.
- LEDs exhibit slightly different characteristics at different drive currents, which might result in larger variation in their performance (that is, intensity, wavelength, and forward voltage). Set the application current as close as possible to the test current to minimize these variations.
- Do not use the LED in the vicinity of material with sulfur content, in environments with high gaseous sulfur compound and corrosive elements. Examples of materials that may contain sulfur are rubber gasket, room temperature vulcanizing (RTV) silicone rubber, rubber gloves etc. Prolonged exposure to such environments may affect the optical characteristics and product life.
- Avoid rapid change in ambient temperature, especially in high-humidity environments, because this causes condensation on the LED.
- Although the LED is rated as IPx6 according to IEC60529: Degree of protection provided by the enclosure, the test condition may not represent actual exposure during application. If the LED is intended to be used in outdoor or harsh environments, protect the LED against damages caused by rain water, dust, oil, corrosive gases, external mechanical stress, and so on.

Thermal Management

Optical, electrical, and reliability characteristics of the LED are affected by temperature. The junction temperature (T_J) of the LED must be kept below allowable limits at all times. T_J can be calculated as below:

$$T_J = T_A + R\theta_{J-A} \times I_F \times V_{Fmax}$$

where;

T_A = ambient temperature ($^{\circ}\text{C}$)

$R\theta_{J-A}$ = thermal resistance from LED junction to ambient ($^{\circ}\text{C}/\text{W}$)

I_F = forward current (A)

V_{Fmax} = maximum forward voltage (V)

The complication of using this formula lies in T_A and $R\theta_{J-A}$. Actual T_A is sometimes subjective and hard to determine. $R\theta_{J-A}$ varies from system to system depending on the design and is usually not known.

Another way of calculating T_J is by using solder point temperature T_S as follows:

$$T_J = T_S + R\theta_{J-S} \times I_F \times V_{Fmax}$$

where;

T_S = LED solder point temperature as shown in the following illustration ($^{\circ}\text{C}$)

$R\theta_{J-S}$ = thermal resistance from junction to solder point ($^{\circ}\text{C}/\text{W}$)

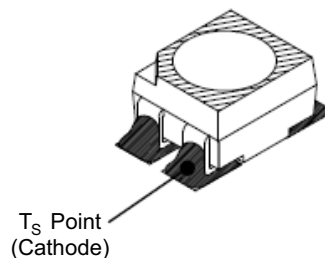

T_S can be measured easily by mounting a thermocouple on the soldering joint as shown in the preceding illustration, while $R\theta_{J-S}$ is provided in the data sheet. Verify the T_S of the LED in the final product to ensure that the LEDs are operated within all maximum ratings as stated in the data sheet.

Broadcom, the pulse logo, Connecting everything, Avago Technologies, Avago, and the A logo are among the trademarks of Broadcom and/or its affiliates in the United States, certain other countries, and/or the EU.

Copyright © 2019 Broadcom. All Rights Reserved.

The term “Broadcom” refers to Broadcom Inc. and/or its subsidiaries. For more information, please visit www.broadcom.com.

Broadcom reserves the right to make changes without further notice to any products or data herein to improve reliability, function, or design. Information furnished by Broadcom is believed to be accurate and reliable. However, Broadcom does not assume any liability arising out of the application or use of this information, nor the application or use of any product or circuit described herein, neither does it convey any license under its patent rights nor the rights of others.