

GloTek, Inc. www.globtek.com 186 Veterans Drive, Northvale, NJ 07647 Tel. (201) 784-1000 Fax (201) 784-0111	Drawing Title: Australia AS/NZS 3112 with ground pin (Type I) to IEC60320 C13 2 CONDUCTORS + GROUND, GT Cable #202: 1.0mmsq / 3 Conductors, 6.8mm OD, GTSA or H05VV-F, 70 Deg.C, 250V, BLU/BRN/GRN-YW, Approvals: SAA/RCM, 2500mm, GlobTek Black
	Model No. Power Cord
Part No./Ordering No. 5502022M5701A(R)	Rev E1

CUSTOMIZED LENGTHS, COLORS, CABLE TYPES, TERMINATIONS/PLUGS/RECEPTACLES AVAILABLE UPON REQUEST. ADDITIONAL PLUG OPTIONS ARE AVAILABLE AT <https://www.globtek.com/connectors/> STANDARD PLUGS AND CONNECTORS CAN BE SEEN ONLINE AT <https://www.globtek.com/connectors/> ACTUAL CONNECTORS, OVERMOLDS, FERRITES MAY VARY SLIGHTLY FROM THE PICTURE BELOW DIMENSIONS ARE IN MM UNLESS SPECIFIED OTHERWISE

In Addition to GlobTek Inc.'s renewed ISO9001:2008 - Quality Management System Certification, GlobTek Inc. is now certified to:

ISO13485:2003 - Medical Devices Quality Management System Certification
ISO14001:2004 - Environmental Management System Certification

ISO Certificates are available online at <https://www.globtek.com/iso-certificates/>
Prop 65 Statement: <https://en.globtek.com/prop-65-statement.pdf>

The acceptance of this specification and use of the product described in this document indicates the acceptance and binding of the customer to Globtek TERMS AND CONDITIONS (attached to the end of this document), which supersede all other agreements, terms, and conditions (<https://en.globtek.com/terms-and-conditions/>).

The purchaser of this product (Customer) agrees that it is their sole responsibility to determine suitability/fitness of the product described in this specification for their application and to take precautions for protection against any hazards attendant to the handling and use of the product.

Footnote:

GlobTek Inc. will not be liable for the safety and performance of these power supplies if unauthorized access and repair occurs. End user should consult applicable UL, CSA or EN standards for proper installation instruction.

Limitation of Use:

GlobTek products are intended for use with commercial, medical, and/or industrial equipment only. GlobTek product are not authorized for use as mission critical components in life support hazardous environment, nuclear or aircraft applications without prior written approval from the CEO of GlobTek Inc.
Contents of this document are subject to change without prior notice.

Customer Approval of Specification:

Please approve, sign and send back to GlobTek so we can complete order processing.
A delay in receipt of this form will delay delivery schedule.

Company Name: _____	Customer P/N: _____
Quote Number: _____	Date: _____
Authorized Representative Name: _____	Authorized Representative Signature: _____

GlobTek, Inc. www.globtek.com 186 Veterans Drive, Northvale, NJ 07647 Tel. (201) 784-1000 Fax (201) 784-0111	Drawing Title: Australia AS/NZS 3112 with ground pin (Type I) to IEC60320 C13 2 CONDUCTORS + GROUND, GT Cable #202: 1.0mmsq / 3 Conductors, 6.8mm OD, GTSA or H05VV-F, 70 Deg.C, 250V, BLU/BRN/GRN-YW, Approvals: SAA/RCM, 2500mm, GlobTek Black	
	Model No. Power Cord	
Part No./Ordering No. 5502022M5701A(R)		Rev E1

CUSTOMIZED LENGTHS, COLORS, CABLE TYPES, TERMINATIONS/PLUGS/RECEPTACLES AVAILABLE UPON REQUEST. ADDITIONAL PLUG OPTIONS ARE AVAILABLE AT <https://www.globtek.com/connectors/> STANDARD PLUGS AND CONNECTORS CAN BE SEEN ONLINE AT <https://www.globtek.com/connectors/> ACTUAL CONNECTORS, OVERMOLDS, FERRITES MAY VARY SLIGHTLY FROM THE PICTURE BELOW DIMENSIONS ARE IN MM UNLESS SPECIFIED OTHERWISE

REVISION HISTORY

REV	DESCRIPTION	SUB	DATE	APPROVED
E1	Adding test parameters	bsiep	09/17/2021	QA
E	Update to SF format	bsiep	05/28/2020	QA

Cordset Information:

CordsetColor:GlobTek Black

Cord Length (mm):2500

NOTES:

Insulation Resistance Test: 5M Ω

Hipot Test - wire to wire: AC 2500V@1sec.

Hipot Test - wire to shell: AC 4500V@1sec.

Leakage Current Test: 1mA

Standard: IEC60884

GlobTek, Inc. www.globtek.com 186 Veterans Drive, Northvale, NJ 07647 Tel. (201) 784-1000 Fax (201) 784-0111	Drawing Title: Australia AS/NZS 3112 with ground pin (Type I) to IEC60320 C13 2 CONDUCTORS + GROUND, GT Cable #202: 1.0mmsq / 3 Conductors, 6.8mm OD, GTSA or H05VV-F, 70 Deg.C, 250V, BLU/BRN/GRN-YW, Approvals: SAA/RCM, 2500mm, GlobTek Black
	Model No. Power Cord
Part No./Ordering No. 5502022M5701A(R)	Rev E1

CUSTOMIZED LENGTHS, COLORS, CABLE TYPES, TERMINATIONS/PLUGS/RECEPTACLES AVAILABLE UPON REQUEST. ADDITIONAL PLUG OPTIONS ARE AVAILABLE AT <https://www.globtek.com/connectors/> STANDARD PLUGS AND CONNECTORS CAN BE SEEN ONLINE AT <https://www.globtek.com/connectors/> ACTUAL CONNECTORS, OVERMOLDS, FERRITES MAY VARY SLIGHTLY FROM THE PICTURE BELOW DIMENSIONS ARE IN MM UNLESS SPECIFIED OTHERWISE

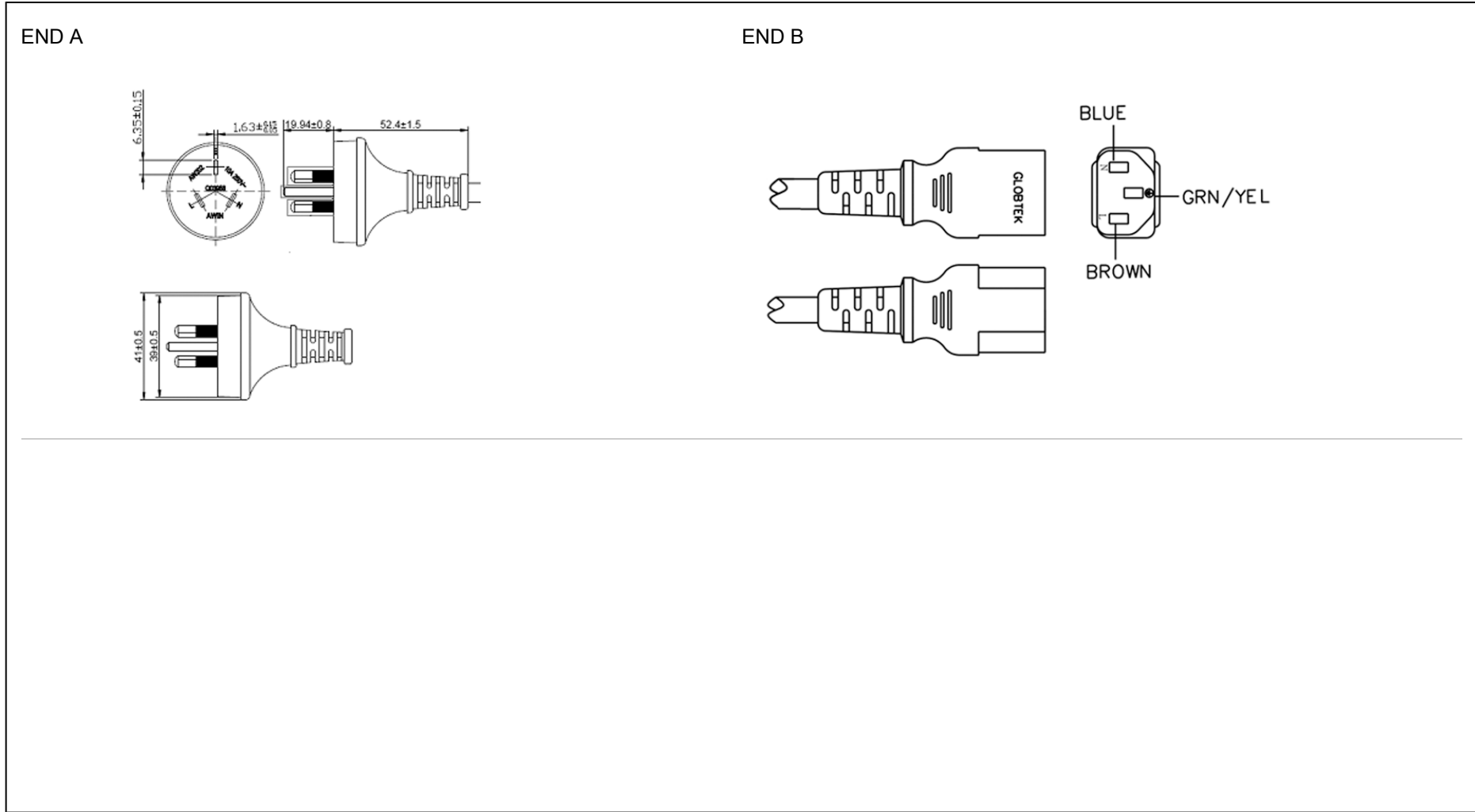

GlobTek, Inc. www.globtek.com 186 Veterans Drive, Northvale, NJ 07647 Tel. (201) 784-1000 Fax (201) 784-0111	Drawing Title: Australia AS/NZS 3112 with ground pin (Type I) to IEC60320 C13 2 CONDUCTORS + GROUND, GT Cable #202: 1.0mmsq / 3 Conductors, 6.8mm OD, GTSA or H05VV-F, 70 Deg.C, 250V, BLU/BRN/GRN-YW, Approvals: SAA/RCM, 2500mm, GlobTek Black
	Model No. Power Cord
Part No./Ordering No. 5502022M5701A(R)	Rev E1

CUSTOMIZED LENGTHS, COLORS, CABLE TYPES, TERMINATIONS/PLUGS/RECEPTACLES AVAILABLE UPON REQUEST. ADDITIONAL PLUG OPTIONS ARE AVAILABLE AT <https://www.globtek.com/connectors/> STANDARD PLUGS AND CONNECTORS CAN BE SEEN ONLINE AT <https://www.globtek.com/connectors/> ACTUAL CONNECTORS, OVERMOLDS, FERRITES MAY VARY SLIGHTLY FROM THE PICTURE BELOW DIMENSIONS ARE IN MM UNLESS SPECIFIED OTHERWISE

CABLE IMAGE

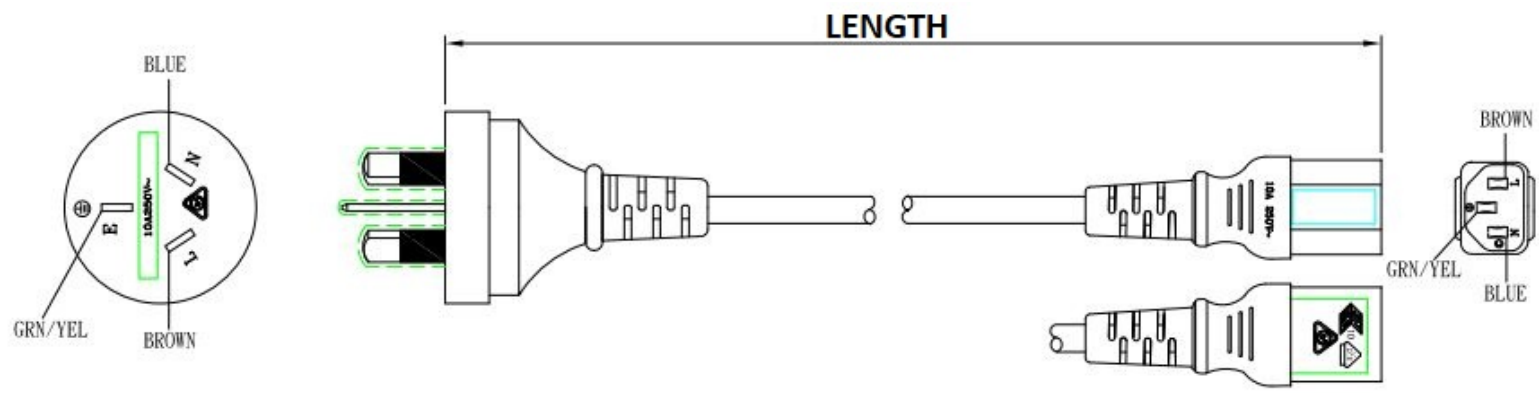

PROPRIETARY INFORMATION



GlobTek, Inc. www.globtek.com 186 Veterans Drive, Northvale, NJ 07647 Tel. (201) 784-1000 Fax (201) 784-0111	Drawing Title: Australia AS/NZS 3112 with ground pin (Type I) to IEC60320 C13 2 CONDUCTORS + GROUND, GT Cable #202: 1.0mmsq / 3 Conductors, 6.8mm OD, GTSA or H05VV-F, 70 Deg.C, 250V, BLU/BRN/GRN-YW, Approvals: SAA/RCM, 2500mm, GlobTek Black	
	Model No. Power Cord	Rev E1
Part No./Ordering No. 5502022M5701A(R)		

CUSTOMIZED LENGTHS, COLORS, CABLE TYPES, TERMINATIONS/PLUGS/RECEPTACLES AVAILABLE UPON REQUEST. ADDITIONAL PLUG OPTIONS ARE AVAILABLE AT <https://www.globtek.com/connectors/> STANDARD PLUGS AND CONNECTORS CAN BE SEEN ONLINE AT <https://www.globtek.com/connectors/> ACTUAL CONNECTORS, OVERMOLDS, FERRITES MAY VARY SLIGHTLY FROM THE PICTURE BELOW DIMENSIONS ARE IN MM UNLESS SPECIFIED OTHERWISE

End A Code:550 Description:Australia AS/NZS 3112 with ground pin (Type I) Rating (V):250 Rating (A):10.0 Gender:Male Overmolded:Yes	Cable Code:202 Description:GT Cable #202: 1.0mmsq / 3 Conductors, 6.8mm OD, GTSA or H05VV-F, 70 Deg.C, 250V, BLU/BRN/GRN-YW, Approvals: SAA/RCM Color:GlobTek Black Wire Gauge(AWG):1.0mmsq Cond:3 Type:GTSA or H05VV-F Temperature:70° C Amps:10 Volts:250 OD:6.8 ConductorsColors:BLU/BRN/GRN-YW	End B Code:701SAA Description:IEC60320 C13 2 CONDUCTORS + GROUND Rating (V):250 Rating (A):10.0 Gender:Female Overmolded:Yes
---	--	--

Overall cable rating:250VAC/10A

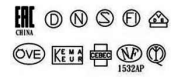
Plug Approvals	Cable Approvals	Connector Approvals
----------------	-----------------	---------------------

 <p>Note: SAA may be indicated by a file number in the format NSWxxxxxx</p>	 <p>European approvals</p>	 <p>Note: RCM Logo may be replaced by valid file number</p>
	 <p>Note: SAA may be indicated by a file number in the format NSWxxxxxx</p>	<p>RCM + ENEC-VDE</p>

AGENCY ONLINE DOCUMENTS	http://en.globtek.com/cordsets/
RoHS/RoHS3 Declaration	https://www.globtek.com/pdf/rohs_cert/01t30000002p8dNAAQ

GlobTek, Inc. www.globtek.com 186 Veterans Drive, Northvale, NJ 07647 Tel. (201) 784-1000 Fax (201) 784-0111	Drawing Title: Australia AS/NZS 3112 with ground pin (Type I) to IEC60320 C13 2 CONDUCTORS + GROUND, GT Cable #202: 1.0mmsq / 3 Conductors, 6.8mm OD, GTSA or H05VV-F, 70 Deg.C, 250V, BLU/BRN/GRN-YW, Approvals: SAA/RCM, 2500mm, GlobTek Black	
	Model No. Power Cord	
	Part No./Ordering No. 5502022M5701A(R)	Rev E1

CUSTOMIZED LENGTHS, COLORS, CABLE TYPES, TERMINATIONS/PLUGS/RECEPTACLES AVAILABLE UPON REQUEST. ADDITIONAL PLUG OPTIONS ARE AVAILABLE AT <https://www.globtek.com/connectors/> STANDARD PLUGS AND CONNECTORS CAN BE SEEN ONLINE AT <https://www.globtek.com/connectors/> ACTUAL CONNECTORS, OVERMOLDS, FERRITES MAY VARY SLIGHTLY FROM THE PICTURE BELOW DIMENSIONS ARE IN MM UNLESS SPECIFIED OTHERWISE

REACH Declaration	https://www.globtek.com/pdf/iso_certificates/REACH.pdf
Conflict Minerals Declaration	https://www.globtek.com/pdf/conflict-minerals.pdf
Prop 65 Statement	https://en.globtek.com/prop-65-statement.pdf
CE.UKCA.Cord	https://globtek.secure.force.com/spec/ec_decl_product_model_family_incl_cord?id=01t30000002p8dN
IPXY rating is based on 3rd party testing and customers should check suitability and test system level IPXY rating before ordering.	

PROPRIETARY INFORMATION

PROPRIETARY OF GLOBTEK, INC. ANY REPRODUCTION, DISCLOSURE OR USE OF THIS DRAWING, IN WHOLE OR IN PART, IS HEREBY PROHIBITED EXCEPT AS SPECIFIED IN WRITING BY GLOBTEK, INC. © GlobTek, Inc.

2012 - 2023

quest /01/30/2023 2:01:59 PM

GlobTek, Inc. www.globtek.com 186 Veterans Drive, Northvale, NJ 07647 Tel. (201) 784-1000 Fax (201) 784-0111	Drawing Title: Australia AS/NZS 3112 with ground pin (Type I) to IEC60320 C13 2 CONDUCTORS + GROUND, GT Cable #202: 1.0mmsq / 3 Conductors, 6.8mm OD, GTSA or H05VV-F, 70 Deg.C, 250V, BLU/BRN/GRN-YW, Approvals: SAA/RCM, 2500mm, GlobTek Black	
	Model No. Power Cord	Part No./Ordering No. 5502022M5701A(R)
		Rev E1

CUSTOMIZED LENGTHS, COLORS, CABLE TYPES, TERMINATIONS/PLUGS/RECEPTACLES AVAILABLE UPON REQUEST. ADDITIONAL PLUG OPTIONS ARE AVAILABLE AT <https://www.globtek.com/connectors/> STANDARD PLUGS AND CONNECTORS CAN BE SEEN ONLINE AT <https://www.globtek.com/connectors/> ACTUAL CONNECTORS, OVERMOLDS, FERRITES MAY VARY SLIGHTLY FROM THE PICTURE BELOW DIMENSIONS ARE IN MM UNLESS SPECIFIED OTHERWISE

Hanking:200
 Description:200 +/- 20mm
 Image:

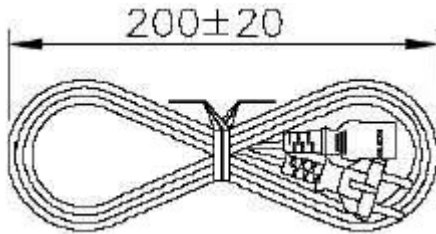

Notes/Modifications/Customizations (notes in this section supersede the values shown in the standard spec):