

## FEATURES

- Versatile analog signal conditioning circuitry**
- On-board reference, clock oscillator and buffers**
- Buffered 14, 16 (or 18) bit parallel outputs**
- Buffered serial port interface**
- Ideal for DSP and data acquisition card interfaces**
- Analog and digital prototyping area**
- EVAL-CONTROL-BOARD compatibility**
- PC software for control and data analysis**

## GENERAL DESCRIPTION

The EVAL-AD76XXCB is an evaluation board for the 48 lead AD761X, AD762X, AD763X, AD764X, AD765X, AD766X, AD767X and AD795X 14-bit, 16-bit and 18-bit PulSAR<sup>®</sup> analog to digital converter (ADC) family. These low power, successive approximation register (SAR) architecture ADCs (see ordering guide for product list) offer very high performance with 100kSPS to 3MSPS throughput rate range with a flexible parallel or serial interface. The evaluation board is designed to demonstrate the ADC's performance and to provide an easy to understand interface for a variety of system applications. A full description of the AD761X, AD762X, AD763X, AD764X, AD765X, AD766X, AD767X and AD795X is available in the Analog Devices data sheets and should be consulted when

utilizing this evaluation board.

The converter installed is an LQFP however, the LFCSP can also be mounted.

The evaluation board is ideal for use with either the Analog Devices EVAL-CONTROL-BRD2 or EVAL-CONTROL-BRD3 (EVAL-CONTROL-BRDX), or as a stand-alone system. The design offers the flexibility of applying external control signals and is capable of generating conversion results on parallel 14-bit, 16-bit or 18-bit wide buffered outputs.

On-board components include a high precision band gap reference, (AD780, ADR431, or ADR435), reference buffers, a signal conditioning circuit with two op-amps and digital logic.

The board interfaces to the EVAL-CONTROL-BRDX with a 96-pin DIN connector. A 40-pin IDC connector is used for parallel output, and test points are provided for the serial port. SMB connectors are provided for the low noise analog signal source, and for an externally generated CNVST (convert start input).

The term AD76XX-48 is used in this document to represent all the 48 lead PulSAR ADCs listed in the ordering guide.

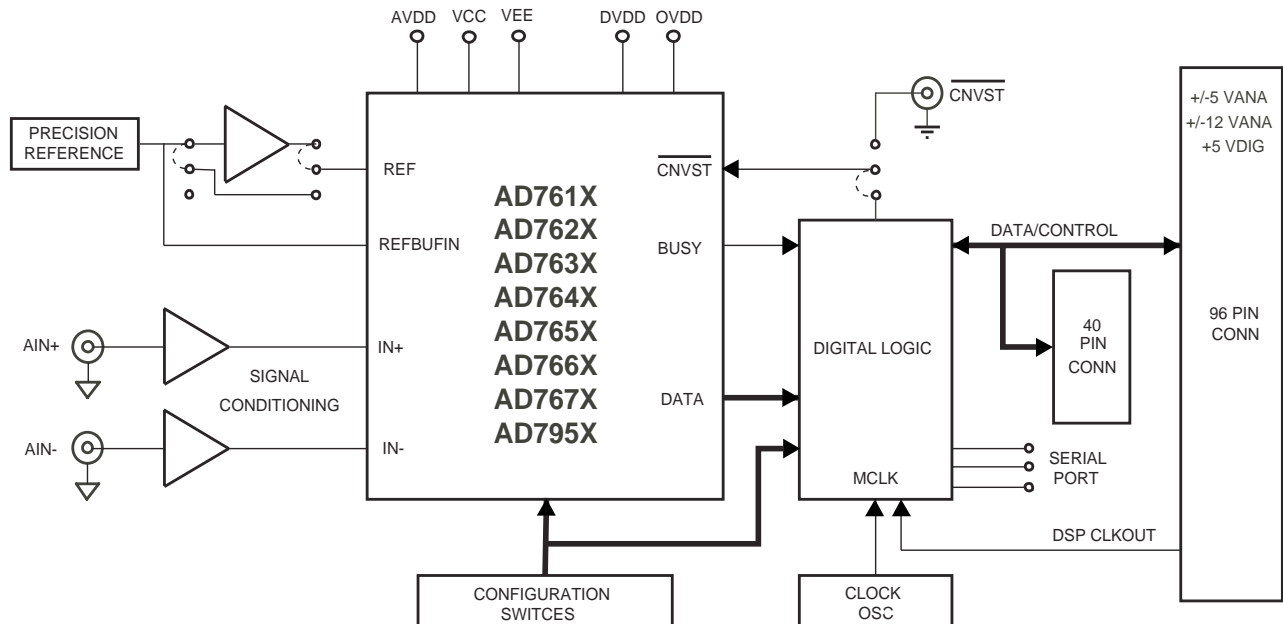

Figure 1. Functional Block Diagram

### Rev. PrW

Information furnished by Analog Devices is believed to be accurate and reliable. However, no responsibility is assumed by Analog Devices for its use, nor for any infringements of patents or other rights of third parties that may result from its use. Specifications subject to change without notice. No license is granted by implication or otherwise under any patent or patent rights of Analog Devices. Trademarks and registered trademarks are the property of their respective owners.

**TABLE OF CONTENTS**

Overview.....	3	Software Installation .....	5
Conversion Control/ Master Clock.....	3	Running the Software .....	5
Analog Input .....	3	Setup Screen.....	5
Power Supplies and Grounding .....	4	DC Testing - Histogram .....	6
Using the Eval-AD762X/AD765X/AD766X/ AD767XCB as Stand-Alone.....	4	AC Testing.....	6
Supplying Power for Stand-Alone use .....	4	Decimated AC Testing (Averaging) .....	6
Evaluation Board Setting for Bipolar ADC Input Configurations.....	5	Serial Programmable Port (AD7610, AD7612, AD7631, AD7634, AD7951) .....	6
Schematics/PCB Layout.....	5	Ordering Information.....	21
Running the EVAL AD76XXCB Software .....	5	Ordering Guide .....	21
Hardware Setup .....	5		

**LIST OF FIGURES**

Figure 1. Functional Block Diagram .....	1	Figure 9. Bottom Side Layer .....	14
Figure 2. Schematic, Analog .....	9	Figure 10. Bottom Side Silk-Screen .....	14
Figure 3. Schematic, Digital .....	10	Figure 11. Setup Screen .....	15
Figure 4. Schematic, Power .....	11	Figure 12. Histogram Screen .....	16
Figure 5. Top Side Silk-Screen.....	12	Figure 13. FFT Screen .....	17
Figure 6. Top Layer .....	12	Figure 14. Time-Domain Screen .....	18
Figure 7. Ground Layer .....	13	Figure 15. Decimated (Averaging) Screen.....	19
Figure 8. Shield Layer .....	13	Figure 16. Serial Programmable Port (SPP) Demo Screen .....	20

**LIST OF TABLES**

Table 1. <a href="#">CNVST</a> Generation, Analog Input Range .....	3	Table 5. S35 - Configuration Select Switch Description.....	7
Table 2. Software Compatible Products.....	5	Table 6. Test Points .....	8
Table 3. Jumper Description.....	7	Table 7. Bill of Materials for the Connectors .....	8
Table 4. S16 - Configuration Select Switch Description .....	7		

**OVERVIEW**

Figure 1 shows a block diagram of the EVAL-AD76XXCB evaluation board. When used in stand-alone mode or in conjunction with the EVAL-CONTROL BRDX, the gate array, U10, provides the necessary control signals for conversion and buffers the ADC data. The evaluation board is a flexible design that enables the user to choose among many different board configurations, analog signal conditioning, reference, and different modes of conversion data.

**CONVERSION CONTROL/ MASTER CLOCK**

Conversion start ( $\overline{\text{CNVST}}$ ) controls the sample rate of the ADC and is the only input needed for conversion; all SAR timing is generated internally.  $\overline{\text{CNVST}}$  is generated either by the gate array or externally via J3 (SMB) and setting JP22 in the external (EXT) position. The evaluation board is factory configured for the  $\overline{\text{CNVST}}$  range shown in Table 1. Externally generated  $\overline{\text{CNVST}}$  should have very low jitter and sharp edges for the maximum dynamic performance of the part. Since  $\overline{\text{CNVST}}$  jitter usually results in poor SNR performance, it is recommended to use the on-board  $\overline{\text{CNVST}}$  generation whenever possible.

The master clock (MCLK) source for the gate array is generated from the DSP CLKOUT pin (buffered) when using the EVAL-CONTROL BRDX or form U12, the 40MHz local oscillator selectabel when using the accompanying software. The range for  $\overline{\text{CNVST}}$  in Table 1 is a ratio generated from this master clock. In stand-alone mode, other clock frequencies can be used to change the gate array generated  $\overline{\text{CNVST}}$  by this ratio. However, other timings will be affected – namely the slave serial clock (SCLK) interface. In serial slave mode, SCLK = MCLK.

While the ADC is converting, activity on the BUSY pin turns on the LED, D2. Additionally, the BUSY signal can be monitored test point TP1. Buffered conversion data (BD) is available at U10 on the output bus BD[0:15] on the 40-pin IDC connector P2, and on the 96-pin connector P3. When operating with the EVAL-CONTROL-BRDX, data is transferred using a 16 bit bus and corresponding word and byte modes selectable with the software. For the 18 bit converters two consecutive 16 bit words are read, however, the ADC data is still read into the gate array as 18 bits. Additionally, BD is updated on the falling edge of BBUSY on P3-C17, and on the rising edge of DBUSY on P2-33. When either parallel or serial reading mode of the ADC is used, data is available on this parallel bus.

When using Serial Mode, serial data is available at T3, T4, T5, and T6 (SDOUT, SCLK, SYNC and RDERROR) and buffered serial data is output on TP17, TP18, and TP19 (SCLK, SYNC, and SDOUT). When using Slave Serial Mode, the external serial clock SCLK applied to the ADC is the MCLK, U12, frequency (40MHz). Refer to the device specific datasheet for full details of the interface modes.

Table 1.  $\overline{\text{CNVST}}$  Generation, Analog Input Range

Part	Res (bits)	Sample Rate	Analog Input Range	Analog Input Type
AD7610	16	250kSPS	0-5V, 0-10V, +/-5V, +/-10V	SE
AD7612	16	750kSPS	0-5V, 0-10V, +/-5V, +/-10V	SE
AD7621	16	3MSPS	0 to 2.5V	Diff, Unipolar
AD7622	16	2MSPS	0 to 2.5V	Diff, Unipolar
AD7623	16	1.33MSPS	0 to 2.5V	Diff, Unipolar
AD7631	16	250kSPS	0-5V, 0-10V, +/-5V, +/-10V	Diff
AD7634	16	670kSPS	0-5V, 0-10V, +/-5V, +/-10V	Diff
AD7641	18	2MSPS	0 to 2.5V	Diff, Unipolar
AD7643	18	1.25MSPS	0 to 2.5V	Diff, Unipolar
AD7650	16	571KSPS	0 to 2.5V	SE, Unipolar
AD7651	16	100KSPS	0 to 2.5V	SE, Unipolar
AD7652	16	500KSPS	0 to 2.5V	SE, Unipolar
AD7653	16	1MSPS	0 to 2.5V	SE, Unipolar
AD7654	16	500KSPS	0 to 5V	2-CH, SE Unipolar
AD7655	16	500KSPS	0 to 5V	4-CH, SE Unipolar
AD7660	16	100KSPS	0 to 2.5V	SE, Unipolar
AD7661	16	100KSPS	0 to 2.5V	SE, Unipolar
AD7663	16	250KSPS	+/-5V	SE, Bipolar
AD7664	16	571KSPS	0 to 2.5V	SE, Unipolar
AD7665	16	571KSPS	+/-5V	SE, Bipolar
AD7666	16	500KSPS	0 to 2.5V	SE, Unipolar
AD7667	16	1MSPS	0 to 2.5V	SE, Unipolar
AD7671	16	1MSPS	+/-5V	SE, Bipolar
AD7674	18	800KSPS	0 to 5V	Diff, Unipolar
AD7675	16	100KSPS	+/-2.5V	Diff, Unipolar
AD7676	16	500KSPS	+/-2.5V	Diff, Unipolar
AD7677	16	1MSPS	+/-2.5V	Diff, Unipolar
AD7678	18	100KSPS	0 to 5V	Diff, Unipolar
AD7679	18	571KSPS	0 to 5V	Diff, Unipolar
AD7951	14	1MSPS	0-5V, 0-10V, +/-5V, +/-10V	SE

**ANALOG INPUT**

The analog input amplifier circuitry U6 and U7 (see schematic - Figure 2) allows flexible configuration changes such as positive or negative gain, input range scaling, filtering, addition of a DC component, use of different op-amp and supplies depending on the ADC. The analog input amplifiers are set as unity gain buffers at the factory. The supplies are selectable with solder pads JP8 (VDRV+) and JP3 (VDRV-) and are set for the ±12V range. Table 1 shows the analog input range for the available evaluation boards.

The default configuration for the single ended (SE) unipolar ADCs sets U6 at mid-scale from the voltage divider ( $V_{CM}^*$

$R6/(R6+R7)$ ) and U7 at mid-scale from the voltage divider ( $V_{CM} * R29/(R29+R60)$ ) for the differential unipolar ADCs.

For the bipolar devices, the input is at 0V (mid-scale). This allows a transition noise test (histogram) without any other equipment. In some applications, it is desired to use a bipolar or wider analog input range, for instance,  $\pm 10V$ ,  $\pm 5V$ ,  $\pm 2.5V$ , or 0 to  $-5V$ . For the AD76XX-48 parts which do not use these input ranges directly, simple modifications of the input driver circuitry can be made without any performance degradation. Refer to the datasheet under the *Application Hints* section for component values or to application note [AN594](#) on the product web page for other input ranges.

For dynamic performance, an FFT test can be done by applying a very low distortion AC source.

## POWER SUPPLIES AND GROUNDING

The evaluation board ground plane is separated into two sections: a plane for the digital interface circuitry and an analog plane for the analog input and external reference circuitry. To attain high resolution performance, the board was designed to ensure that all digital ground return paths do not cross the analog ground return paths by connecting the planes together directly under the converter. Power is supplied to the board through P3 when using with the EVAL-CONTROL-BRD

## USING THE EVAL-AD762X/AD765X/AD766X/AD767XCB AS STAND-ALONE

Using the evaluation board as stand-alone does not require the EVAL-CONTROL-BRD nor does it require use of the accompanied software. When the CONTROL input to the gate array is LOW, which is pulled down by default, the gate array provides the necessary signals for conversion and buffers the conversion data.

In stand-alone mode, the gate arrays flexible logic buffers the ADC data according to the read data mode configuration (word or byte). In parallel reading mode the board is configured for continuous reading since  $\overline{CS}$  and  $\overline{RD}$  are always driven LOW by the gate array. Thus, the digital bus is not tri-stated in this mode of operation and BD[0:15] will continuously be updated after a new conversion. BD[0:15] is available on P2 after BUSY goes HIGH. Note that with the 18 bit devices the full 18 bits of data BD[-2:15] are output directly on P2 since the evaluation board is not limited to 16 bit wide transfers in stand-alone operation. When either parallel or serial reading mode, the data is available on this parallel bus. Refer to Figure 2 to obtain the data output pins on P2.

### Configuration Switches

The evaluation board is configurable for the different operating modes with 16 positions on the configuration select switches, S16 and S35. A description of each switch setting and jumper position is listed in Table 4 and the available test points are

listed in Table 6. Note that the switches in the ON position define a logic HIGH level (pulled up with 10k $\Omega$ ,) and that the switches are active only in stand-alone mode.

For all interface modes, S16 and S35 allows the selection of:  
 Warp, Normal or Impulse mode conversions (where applicable)  
 Binary or 2s complement data output  
 Reading during or after conversion  
 Resetting the ADC  
 ADC power-down  
 Internal Reference and Buffer power-down (where applicable)

In parallel reading mode, s16 allows the selection of:  
 Byte swapping for 8 bit interfacing (LSByte with MSByte)  
 18-bit, 16-bit and 8-bit interfacing (for 18-bit converters)

In serial reading mode, the default settings are Master Read during Conversion Mode using the internal ADC serial clock. Serial data is available at T3, T4, T5 and T6 for SDO, SCLK, SYNC and RDERROR respectively. Buffered serial data is output on the three test points TP17, TP18 and TP19 for SCLK, SYNC, and SDO respectively.

For serial reading mode, S16 allows the selection of:  
 Choice of inverting SCLK and SYNC  
 Choice of using internal or external (slave mode) SCLK

## SUPPLYING POWER FOR STAND-ALONE USE

Power needs to be supplied through the two power supply blocks SJ1 and SJ2. Linear supplies are recommended. SJ1 is the analog supply for the ADC (AVDD), front end op amps and reference circuitry. SJ2 is the digital supply for the ADC (DVDD, OVDD) and gate array. The supplies to the device are configurable through the power supply jumpers shown in Figure 4 and

Table 3. In most applications four supplies are required;  $\pm 12\text{V}$  and  $+5\text{V}$  for analog, and  $+5\text{V}$  for digital. On board regulators, where applicable, are used to reduce the operating voltages to the correct levels. The analog and digital supplies can be from the same source however, R27 (typically  $20\Omega$ ) is required from AVDD to DVDD. In this configuration, JP9, DVDD selection, should be left open. Furthermore, the OVDD (ADC digital output supply) may need to be brought up after the analog  $+5\text{V}$  supply. See datasheet for details.

## EVALUATION BOARD SETTING FOR BIPOLAR ADC INPUT CONFIGURATIONS

The AD7610, AD7612, AD7631, AD7634, AD7663, AD7665, AD7671, and AD7951 can use both unipolar and bipolar ranges. The available options are  $\pm 10\text{V}$ ,  $\pm 5\text{V}$ ,  $\pm 2.5\text{V}$ ,  $0$  to  $10\text{V}$ ,  $0$  to  $5\text{V}$  and  $0$  to  $2.5\text{V}$  (depending on the ADC).

For the AD7663, AD7665 and AD7671 the evaluation board is set for the  $\pm 5\text{V}$  bipolar input range since these ADCs input ranges are hardware pin strapped. Simple modifications to these evaluation boards can be made to accommodate the different input ranges by changing the INA-IND inputs with the available solder pads.

### iCMOS ADCs

For the AD7610, AD7612, AD7631 AD7634 and AD7951, the evaluation board can use all input ranges since the input range is controlled by software (or S16 DIP switches in stand-alone mode).

For operating in unipolar mode for any of the bipolar evaluation boards it is recommended to use the voltage divider consisting of  $(V_{\text{CM}} * R6 / (R6 + R7))$  and  $(V_{\text{CM}} * R29 / (R29 + R60))$ . This allows a transition noise test without any additional equipment.

## SCHEMATICS/PCB LAYOUT

The EVAL-AD76XXCB is a 4-layer board carefully laid out and tested to demonstrate the specific high accuracy performance of the AD76XX-48 device. Figure 2, Figure 3, and Figure 4, shows the schematics of the evaluation board. The printed circuit layouts of the board are given in Figure 5 - Figure 10. Note these layouts are not to scale.

Top side silk-screen - Figure 5

Top side layer - Figure 6

Ground layer - Figure 7

Shield layer - Figure 8

Bottom side layer - Figure 9

Bottom side silk-screen - Figure 10

## RUNNING THE EVAL AD76XXCB SOFTWARE

The evaluation board includes software for analyzing the AD761X, AD762X, AD763X, AD764X, AD765X, AD766X, AD767X, AD795X, AD67X and AD97x family. The EVAL-CONTROL-BRDx is required when using the software. The

software is used to perform the following tests:

- Histogram for determining code transition noise (DC)
- Fast Fourier transforms (FFT) for signal to noise ratio (SNR), SNR and distortion (SINAD), total harmonic distortion (THD) and spurious free dynamic range (SFDR)
- Decimation (digital filtering)

The evaluation software described in this document is also compatible with the following previous generation of high resolution ADCs.

**Table 2. Software Compatible Products**

EVAL AD676EB
EVAL AD677EB
EVAL AD974CB
EVAL AD976CB
EVAL AD976ACB
EVAL AD977CB
EVAL AD977ACB

## HARDWARE SETUP

### System Requirements

- Evaluation Board
- Evaluation Control Board 3 (or Board 2, not in production any longer)
- AC Power Supply (AC 14V/1A source - can be purchased from ADI)
- IEEE 1284 Compliant Parallel Port Cable (if not supplied)
- DC source (low noise for checking different input ranges)
- AC source (low distortion)
- Bandpass filter suitable for 16 or 18 bit testing (value based on signal frequency)
- PC operating Windows 2000 or XP.

Connect the control board supplied mini plug to the 14V AC source. Connect the evaluation board to the controller board and connect the parallel port cable to the evaluation board and to the PC .

## SOFTWARE INSTALLATION

Double-Click on *setup.exe* from the CD-ROM and follow the installation instructions. If upgrading the software, the previous version will first be removed. Thus *setup.exe* will need to be run again to install the new version. Reboot the computer.

## RUNNING THE SOFTWARE

To run the software, use "Program Files", "Analog Devices ADC" "ADC.exe". The software has four screens as shown in Figure 11 through Figure 15. For the AD7610, AD7612, AD7631, AD7634 and AD7951, Figure 16 is a screen showing the Serial Programmable Port demonstration.

## SETUP SCREEN

Figure 11 is the setup screen where ADC device selection, test type, input voltage range, sample rate and number of samples are selected.

### DC TESTING - HISTOGRAM

Figure 12 is the histogram screen, which tests the code distribution for DC input and computes the mean and standard deviation or transition noise. To perform a histogram test, select “Histogram” from the test selection window and click on the “Start” radio button. Note: a histogram test can be performed without an external source since the evaluation board has a buffered  $V_{REF}/2$  source at the ADC input for unipolar parts and at 0V for bipolar devices. To test other DC values, apply a source to the J1/J2 inputs. It is advised to filter the signal to make the DC source noise compatible with that of the ADC. C26/C41 provide this filtering.

### AC TESTING

Figure 13 is the FFT screen, which performs an FFT on the captured data and computes the SNR, SINAD, THD and SFDR. Figure 14 is the time domain representation of the output. To perform an AC test, apply a sinusoidal signal to the evaluation board at the SMB inputs J1 for IN+ and J2 for IN-. Low distortion, better than 100dB, is required to allow true evaluation of the part. One possibility is to filter the input signal from the AC source. There is no suggested bandpass filter but consideration should be taken in the choice. Furthermore, if using a low frequency bandpass filter when the full-scale input range is more than a few  $V_{pp}$ , it is recommended to use the on board amplifiers to amplify the signal, thus preventing the filter from distorting the input signal.

### DECIMATED AC TESTING (AVERAGING)

The AC performances can be evaluated after digital filtering with enhanced resolution of up to 32 bits. Figure 15 is the FFT screen when decimation is used. Additional bits of resolution are attained when over sampling by:

$$f_{\text{OVERSAMPLE}} = 4^N * f_{\text{SAMPLE}}$$

where,  $N$  = number of bits and  $4^N$  = the DRATIO. Set the DRATIO to the amount of over sampling desired. When using decimation, the test duration increases with the larger number of samples taken. The decimated test requires the EVAL-CONTROL-BRD3.

### SERIAL PROGRAMMABLE PORT (AD7610, AD7612, AD7631, AD7634, AD7951)

Figure 16 is a screen showing the flexible serial programmable port (SPP) used on the AD7610, AD7612, AD7631, AD7634 and AD7951 iCMOS ADCs. The SPP can be used in any serial mode and allows the configuration of: unipolar and bipolar input ranges, mode selection, straight binary or 2's complement output coding, and power down. The software demo allows two different configurations and alternates between these two every ten samples. To use just one range or mode, simply enter the same values into both “A” and “B” configuration windows. Note that when using the unipolar input ranges, a common mode voltage must be provided externally (DC coupled) as the board is configured with the common mode = 0V

**Table 3. Jumper Description**

Jumper	Name	Default Position	Function
JP1, JP2	BUFF	BUFF	Buffer amplifier: BUFF = use op amps to buffer analog input. NO BUFF = direct input from J1, J2 (SMB).
JP3	VDRV-	-12V	Buffer amplifier negative supply: Selection of -12V, -5V or GND when using EVAL-CONTROL-BRDX or voltages on SJ1 in stand alone mode.
JP4	REFS	REF	Reference selection: REF = use on board reference output for ADC reference. VDD = use analog supply (AVDD) for ADC reference.
JP6	OVDD	3.3V	ADC digital output supply voltage: Selection of 2.5V, 3.3V and VDIG. VDIG = +5V when using EVAL-CONTROL-BRDX or voltage on SJ2 in stand-alone mode.
JP7	VREF+	+12V	Reference circuit positive supply: Selection of +12V, +5V or AVDD when using EVAL-CONTROL-BRDX or voltages on SJ1 in stand alone mode.
JP8	VDRV+	+12V	Buffer amplifier positive supply: Selection of +12V, +5V or AVDD when using EVAL-CONTROL-BRDX or voltages on SJ1 in stand alone mode.
JP9	DVDD	VDIG/2.5 <sup>1</sup>	ADC digital supply voltage: Selection of +2.5V or VDIG (+5V) when using EVAL-CONTROL-BRDX or voltage on SJ2 in stand-alone mode.
JP19	AVDD	+5V/2.5 <sup>1</sup>	ADC analog supply voltage: Selection of +2.5V, +5V or EXT when using EVAL-CONTROL-BRDX
JP20	REFB	BUF	Reference buffer: BUFF = use U2 to buffer or amplify reference source. NO BUFF = use reference directly into ADC.
JP21	VIO	3.3V	Gate array I/O voltage: Selection of 3.3V or OVDD. Note: gate array will be damaged if >3.3V (ie. when using OVDD = VDIG).
JP22	$\overline{\text{CNVST}}$	INT	$\overline{\text{CNVST}}$ source: INT = use gate array to generate $\overline{\text{CNVST}}$ . EXT = use external source into J3, SMB for $\overline{\text{CNVST}}$ .

<sup>1</sup> For AD7621/AD7641 these are set to +2.5V. Note that setting these to +5V will permanently destruct the ADC.

**Table 4. S16 - Configuration Select Switch Description**

Note: (OFF = LOW, ON = HIGH)

Position	Name	Default Position	Function
1	WARP	LOW	Conversion mode selection: Used in conjunction with IMPULSE. When HIGH with IMPULSE= LOW, the fastest (Warp) mode is used for maximum throughput. When LOW and IMPULSE = LOW, Normal mode is used.
2	IMPULSE	LOW	Conversion mode selection: Used in conjunction with WARP. When HIGH with WARP = LOW, a reduced power mode is used in which the power consumption is proportional to the throughput rate.
3	BIP	LOW	For future use.
4	TEN	LOW	For future use.
5	A0/M0	LOW	A0, input Mux selection: Used for AD7654/AD7655 (refer to datasheet). M0, data output interface selection: Used along with M1 for 18-bit ADCs.
6	BYTE/M1	LOW	BYTESWAP, used for 8-bit interface mode on 16-bit ADCs: MSByte is swapped with LSByte on 8 data lines. M1, data output interface selection: Used along with M0 for 18-bit ADCs.
7	$\text{OB}/\overline{2\text{C}}$	HIGH	Data output select: LOW = Use 2's complement output. HIGH = Straight binary output.
8	$\text{SER}/\overline{\text{PAR}}$	LOW	Data output interface select: LOW = Parallel interface. HIGH = Serial interface.
9	$\text{EXT}/\overline{\text{INT}}$	LOW	Serial clock source select: LOW = Use ADC internal serial clock, SCLK is an output. HIGH= Use external clock, which is MCLK (40 MHz) and SCLK is an input. Not used in parallel reading mode.
10	INVSYNC	LOW	Serial sync (SYNC) active state: LOW = SYNC is active HIGH. HIGH = SYNC is active LOW. Used only for Master mode (internal SCLK). Not used in parallel reading mode.
11	INVSCLK	LOW	Serial clock (SCLK) active edge: LOW = Use SCLK falling edge. HIGH = Use SCLK rising edge. Active in all serial modes. Not used in parallel reading mode.
12	RDC	LOW	Read during convert: LOW = Read data after conversion (BUSY = LOW). HIGH = Read data during conversions (BUSY = HIGH). Used in both parallel and serial interface modes.

**Table 5. S35 - Configuration Select Switch Description**

Note: (OFF = LOW, ON = HIGH)

Position	Name	Default Position	Function
1	RESET	LOW	Reset ADC: LOW = Enables the converter. HIGH = Abort conversion (if any).
2	PD	LOW	Power down: LOW = Enables the converter . HIGH = Powers down the converter. Power consumption is reduced to a minimum after the current conversion.
3	PDBUF	LOW	Internal reference buffer power down: LOW = Enable on chip buffer. HIGH = Power down internal buffer.
4	PDREF	LOW	Internal reference power down: LOW = Enable on chip reference. HIGH = Power down internal reference. Note that when using the on chip reference, the buffer also needs to be enabled (PDREF = PDBUF = HIGH).

**Table 6. Test Points**

Test Point	Available Signal	Type	Description
TP1	BUSY	Output	BUSY signal.
TP2	A0/M0	Input	Same as S16, position 5
TP3	SIG+	Input	Analog +input.
TP4	AGND	GND	Analog ground close to SIG+.
TP5	REF	Input/Output	Reference input. Output for devices with on-chip reference.
TP7	DGND	GND	Digital ground near SJ2.
TP8	$\overline{\text{CNVST}}$	Input	$\overline{\text{CNVST}}$ signal.
TP9	AGND	GND	Analog ground close to REF.
TP10	$\overline{\text{CS}}$	Input	$\overline{\text{CS}}$ , chip select signal.
TP11	$\overline{\text{RD}}$	Input	$\overline{\text{RD}}$ , read signal.
TP12	OVDD	Power	Digital output supply.
TP13	DVDD	Power	Digital core supply.
TP14	AVDD	Power	Analog supply.
TP15	AGND	GND	Analog ground close to SIG-.
TP16	SIG-	Input	Analog –input for differential parts.
TP17	SCLK	Input/Output	Buffered serial clock.
TP18	SYNC	Output	Buffered serial sync.
TP19	SDOUT	Output	Buffered serial data.
TP20	TEMP	Output	TEMP, for ADC with internal reference. Outputs temperature dependant voltage (approx. 300mV with $T_A = 25^\circ\text{C}$ ).
TP22	REFIN	Input/Ouput	For ADCs with internal reference, REFBUFIN can be used to connect external reference into the reference buffer input when PDBUF = LOW and PDREF = HIGH. With the internal reference (and buffer) enabled, this pin will produce the intenal bandgap refrence voltage.
TP23	BVDD	Output	Internal reference bandgap supply. Connected to AVDD via s19.
T3	SDOUT	Output	Direct ADC serial data.
T4	SCLK	Input/Output	Direct ADC serial clock.
T5	SYNC	Output	Direct ADC serial SYNC.
T6	RDERROR	Output	Direct ADC serial read error.

**Table 7. Bill of Materials for the Connectors**

Ref Des	Connector Type	Manf.	Part No.
J1 – J3	RT Angle SMB Male	Pasternack	PE4177
P2	0.100 X 0.100 straight IDC header 2X20	3M	2540-6002UB
P3	32X3 RT PC MOUNT CONNECTOR	ERNI	533402



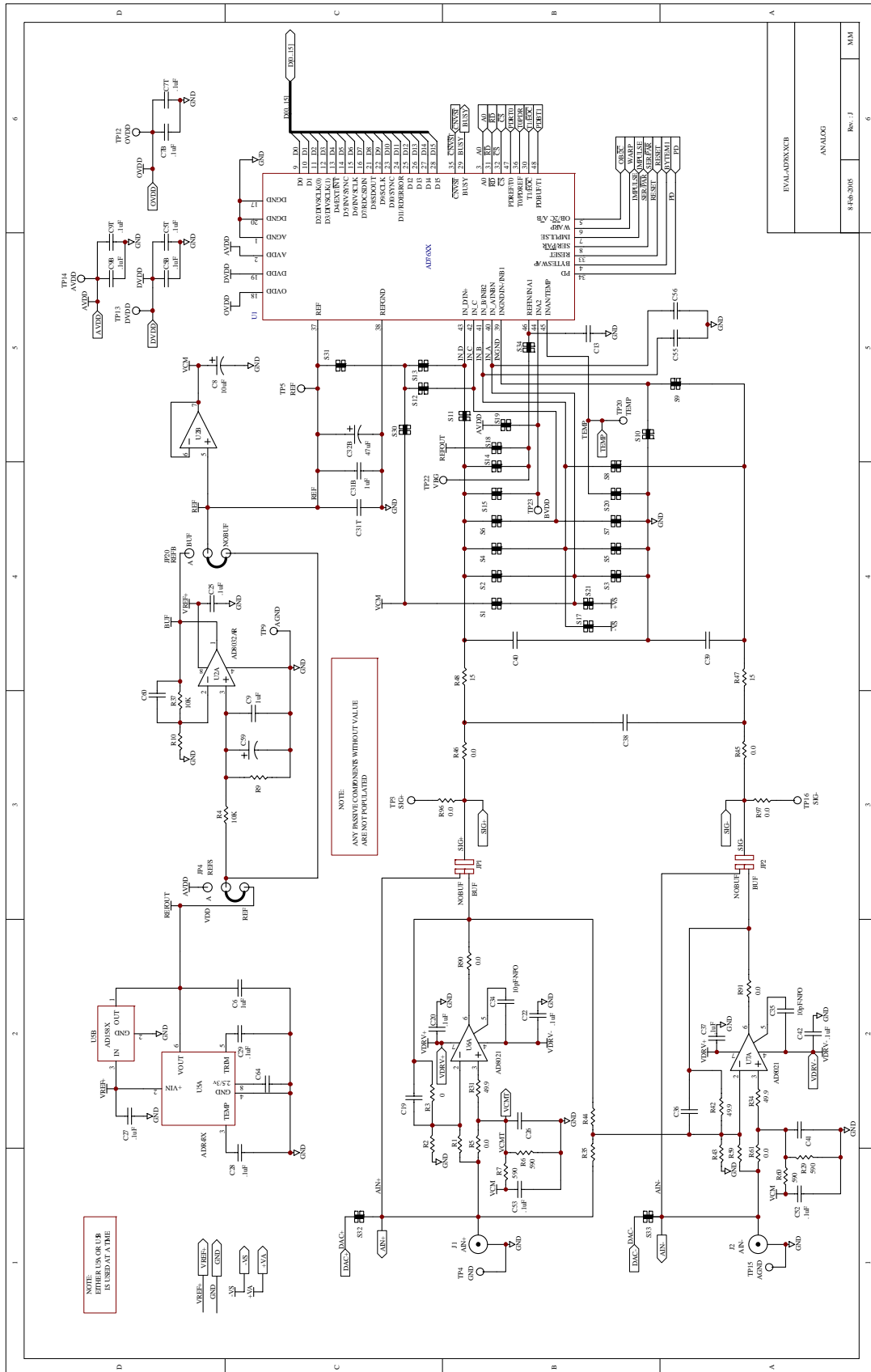

Figure 2. Schematic, Analog





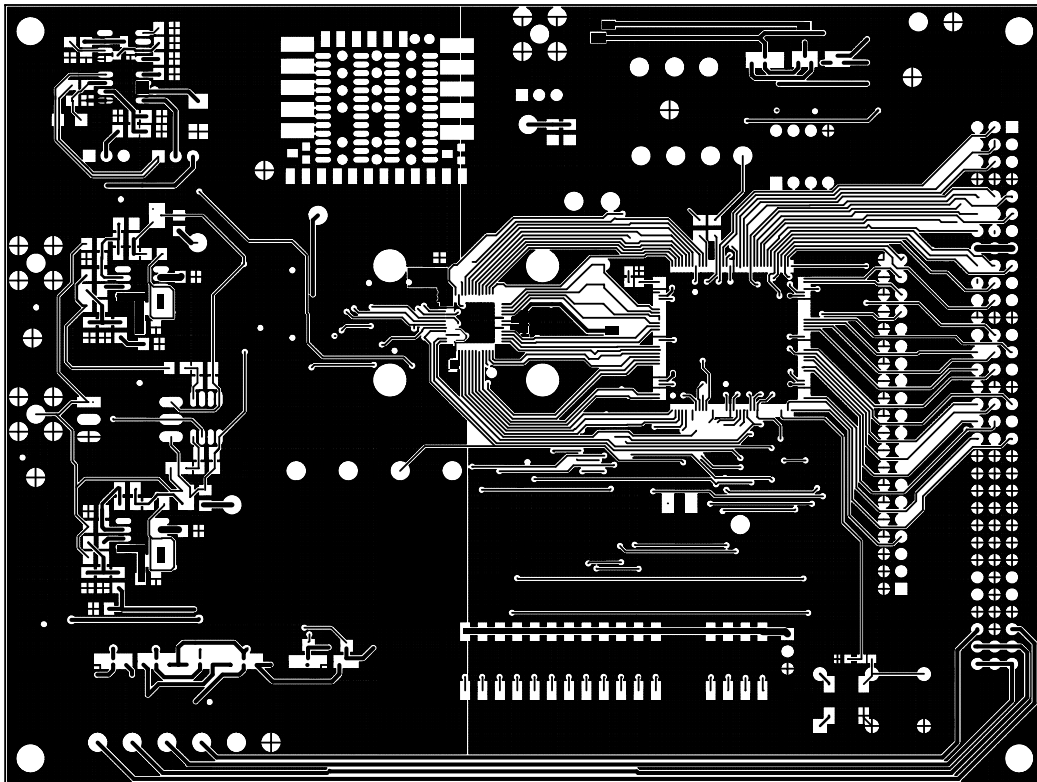
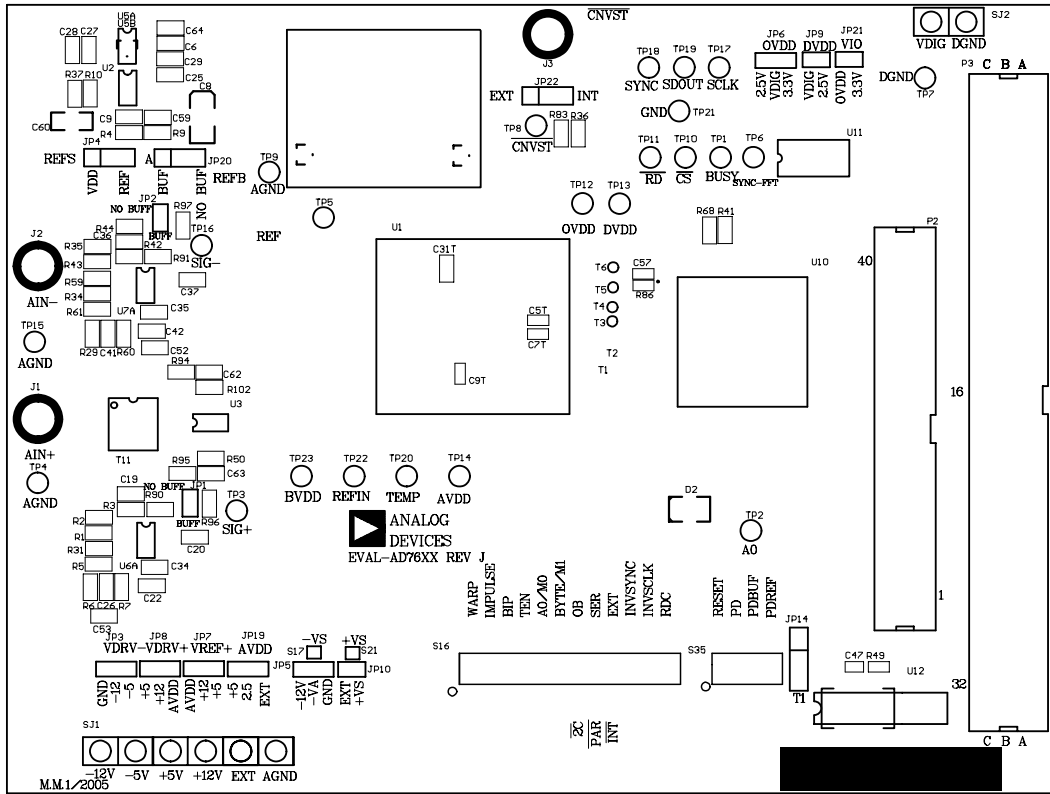

Figure 6. Top Layer

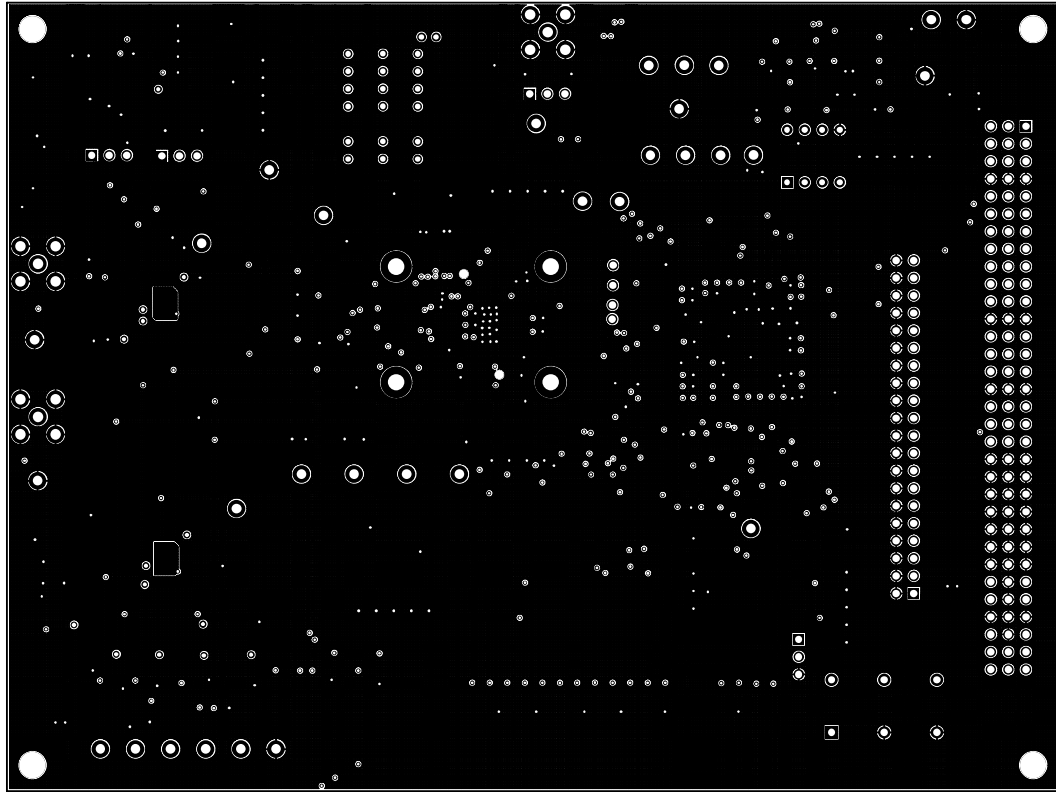

Figure 7. Ground Layer

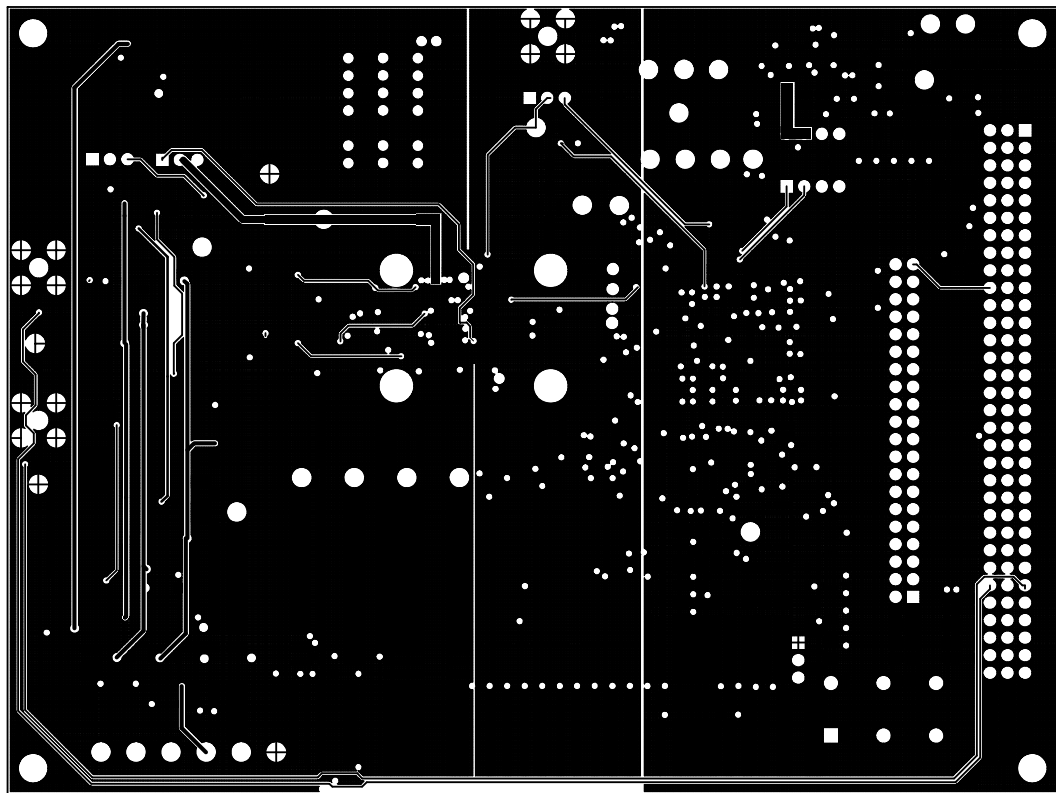

Figure 8. Shield Layer

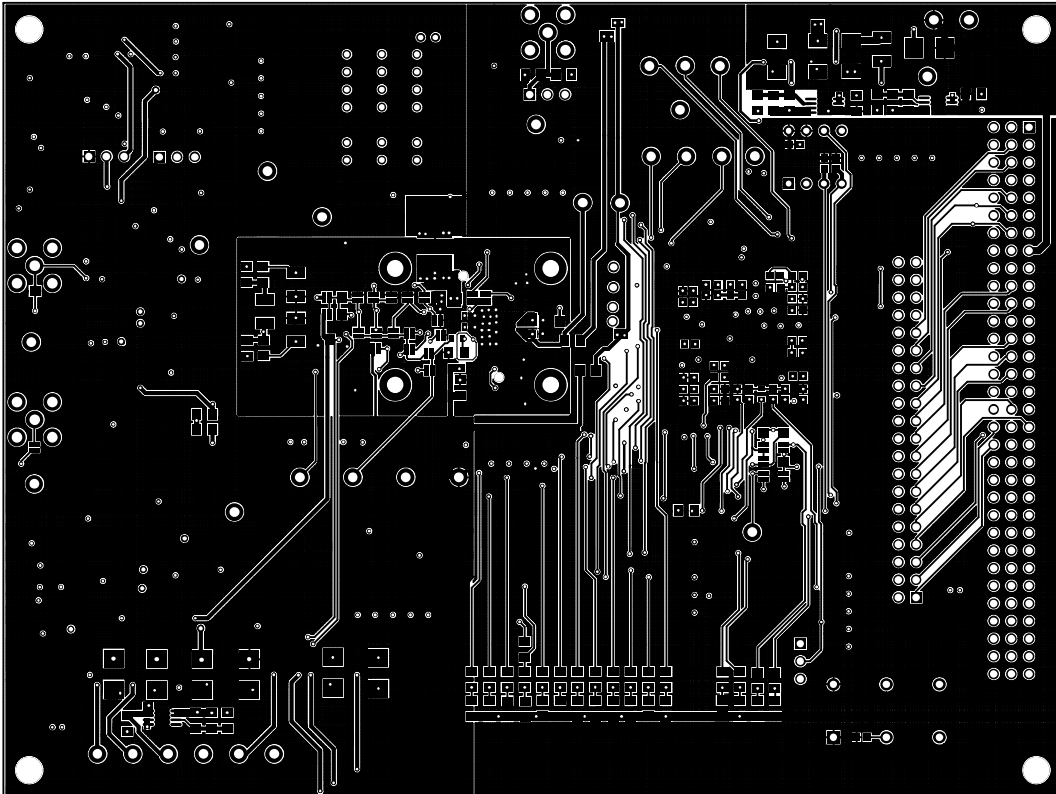

Figure 9. Bottom Side Layer

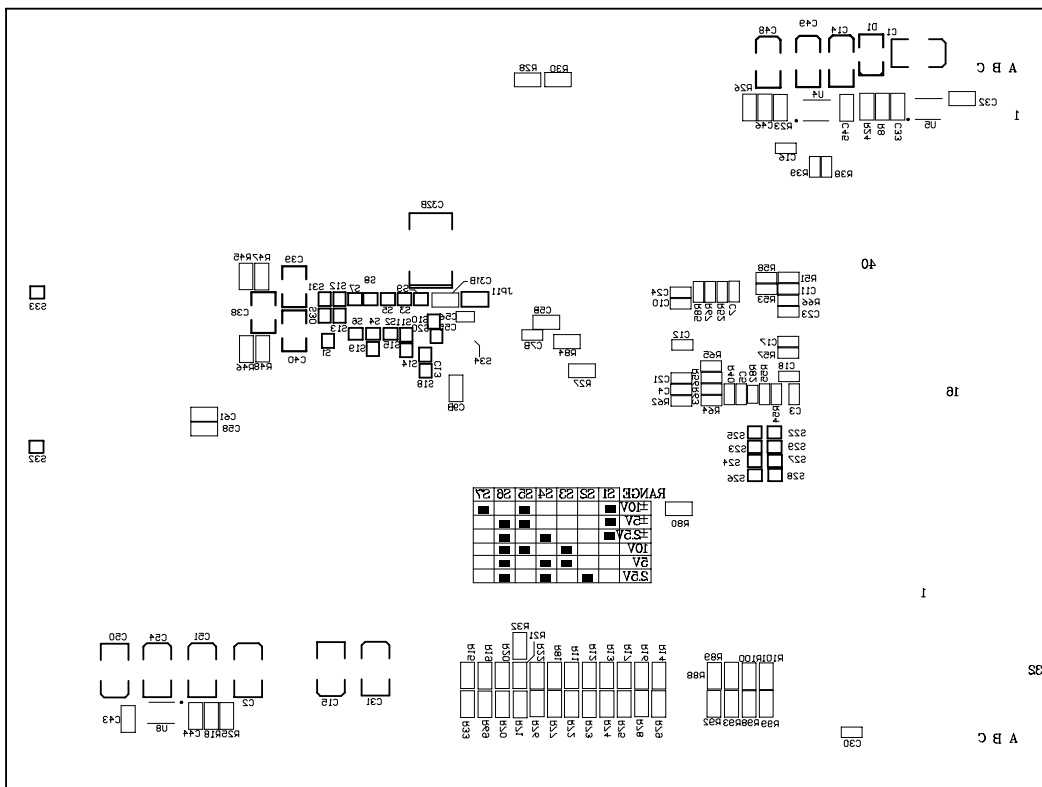
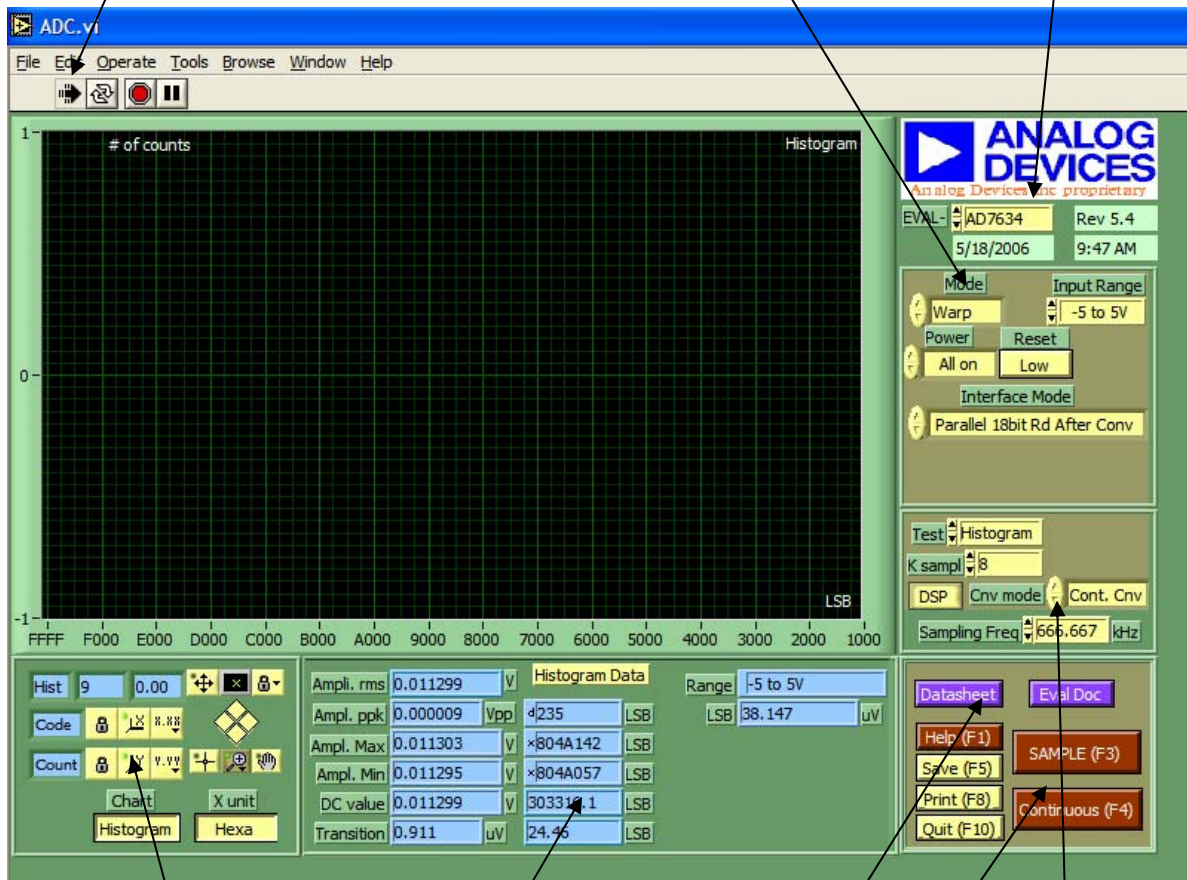

Figure 10. Bottom Side Silk-Screen

1) The Run button starts the software. This button must be pressed first.

2) The part under evaluation is chosen from this menu. The device must be selected second.

3) Input configurations are chosen here. The available choices are: Mode (conversion), Power, Reset, Coding and Interface Mode (digital).



This is the performance window.

These controls are for locking and resetting the display axis to the data minimum and maximum values.

6) Documentation (F2) gives direct access to datasheets and evaluation documentation.

5) This window allow the samples to be taken once (F3) or continuous (F4). Also selects: Help screen, Save data (F5), Print (F8) and Quit (F10). The Help menu shows a description of the functionality of the chosen command.

4) This window is used to select the test type, number of Ksamples, and conversion mode (continuous or burst). For the test type choose from either:

- Histogram test
- AC Test
- Decimated AC Test

Figure 11. Setup Screen

The results are displayed in this chart. Also, the cursor (yellow) can be dragged it to a desired location where the X-axis values and the Y-axis value will be displayed.

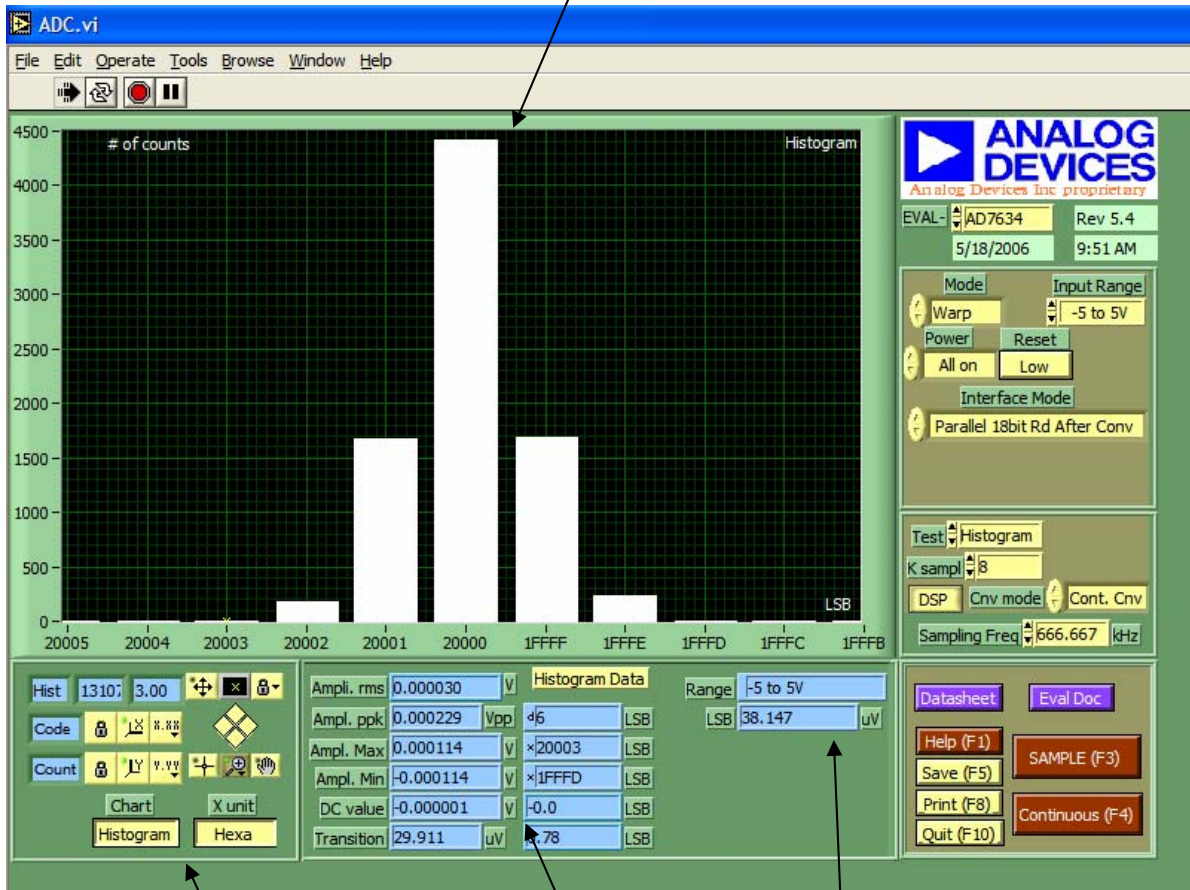

These control the choice of chart type and X-units. Chart type selection of Histogram or Time and X-units of hexadecimal or Volts.

This window shows the ADC range and LSB value in Volts.

Different measurements are displayed here. The DC value, Transition Noise and other values

Figure 12. Histogram Screen



The results are displayed in this chart. Also, the cursor (yellow) can be dragged it to a desired location where the X-axis values and the Y-axis value will be displayed.

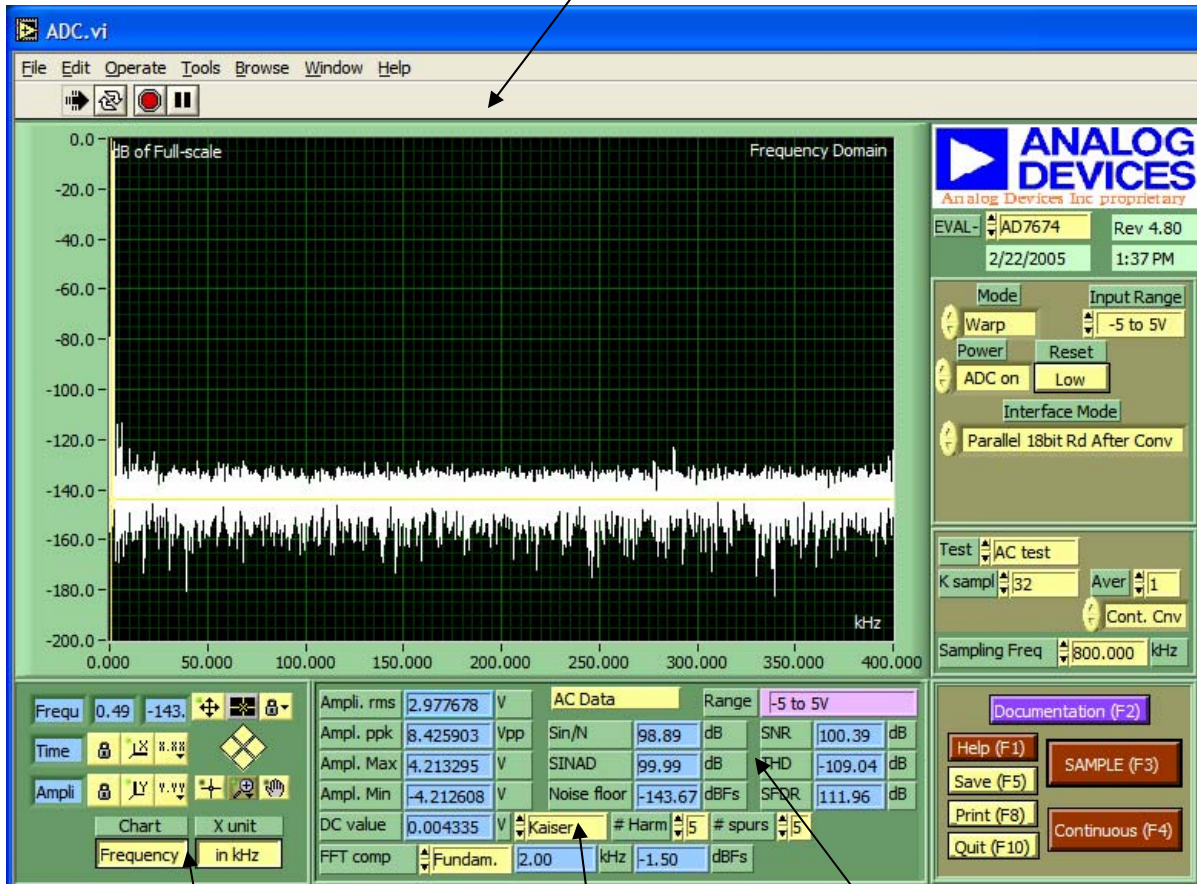

These control the chart type choice of Frequency domain or Time domain and X axis units.

AC test results are displayed here. Also the choice of viewing the amplitude of a certain FFT component can be selected from the FFT component menu.

Choice of either a Kaiser window or a Blackmann-Harris window from the is menu.

Figure 13. FFT Screen

The AC test can also be displayed in the Time Domain as shown below.

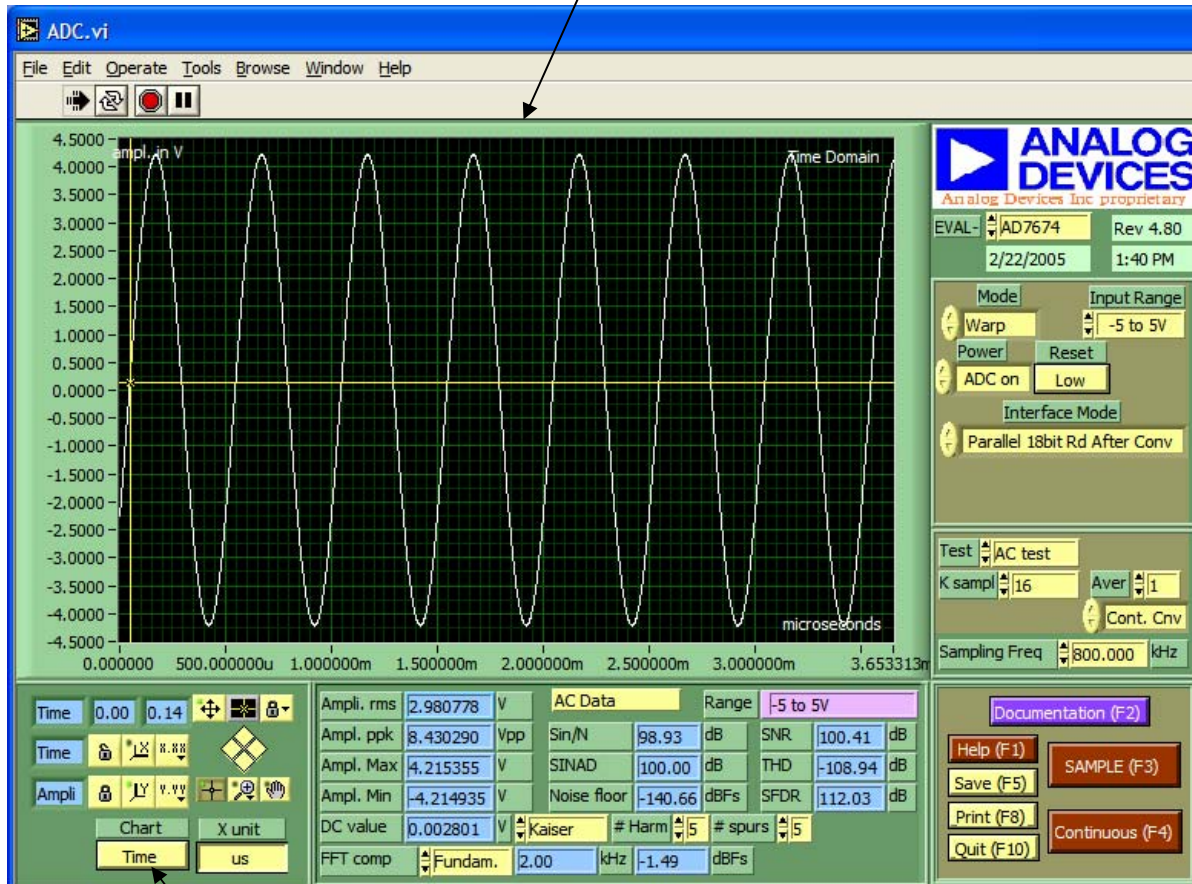

To view the Time domain output, select Time in this menu.

Figure 14. Time-Domain Screen

The results are displayed in this chart. Also, the cursor (yellow) can be dragged to a desired location where the X-axis values and the Y-axis value will be displayed.

The decimation ratio (Dratio) and number of Ksamples are entered here.

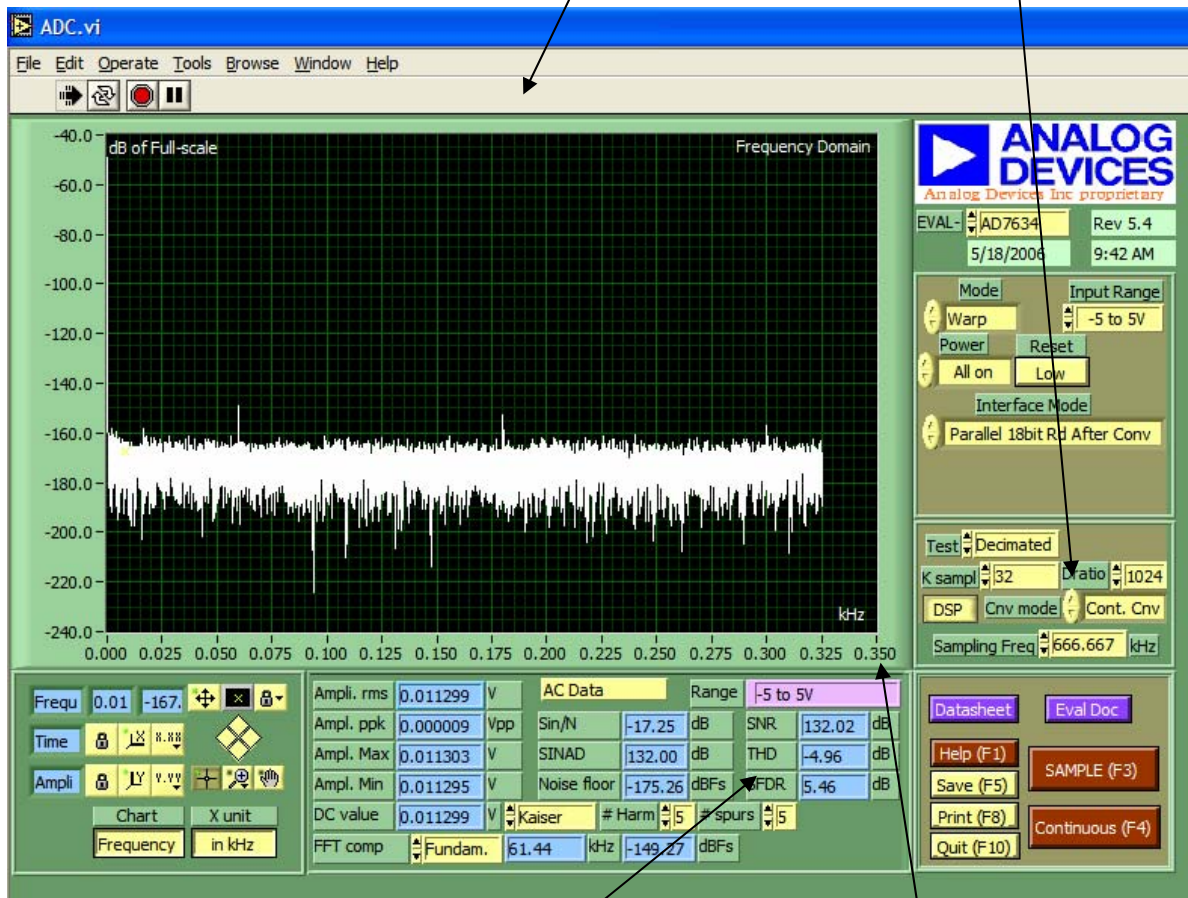

AC test results with decimated averaging are shown here. The SNR indicator also represents the dynamic range when no signal is present.

The Nyquist frequency is displayed here as:

$$F_{\text{NYQUIST}} = \frac{F_{\text{SAMPLE}}}{2 * D_{\text{RATIO}}}$$

Figure 15. Decimated (Averaging) Screen

This selects the interface mode. Any of the four serial modes can be used to program the ADC through the Serial Programmable Port

This selects the input range configured through the Serial Programmable Port (SPP) or hardware pins.

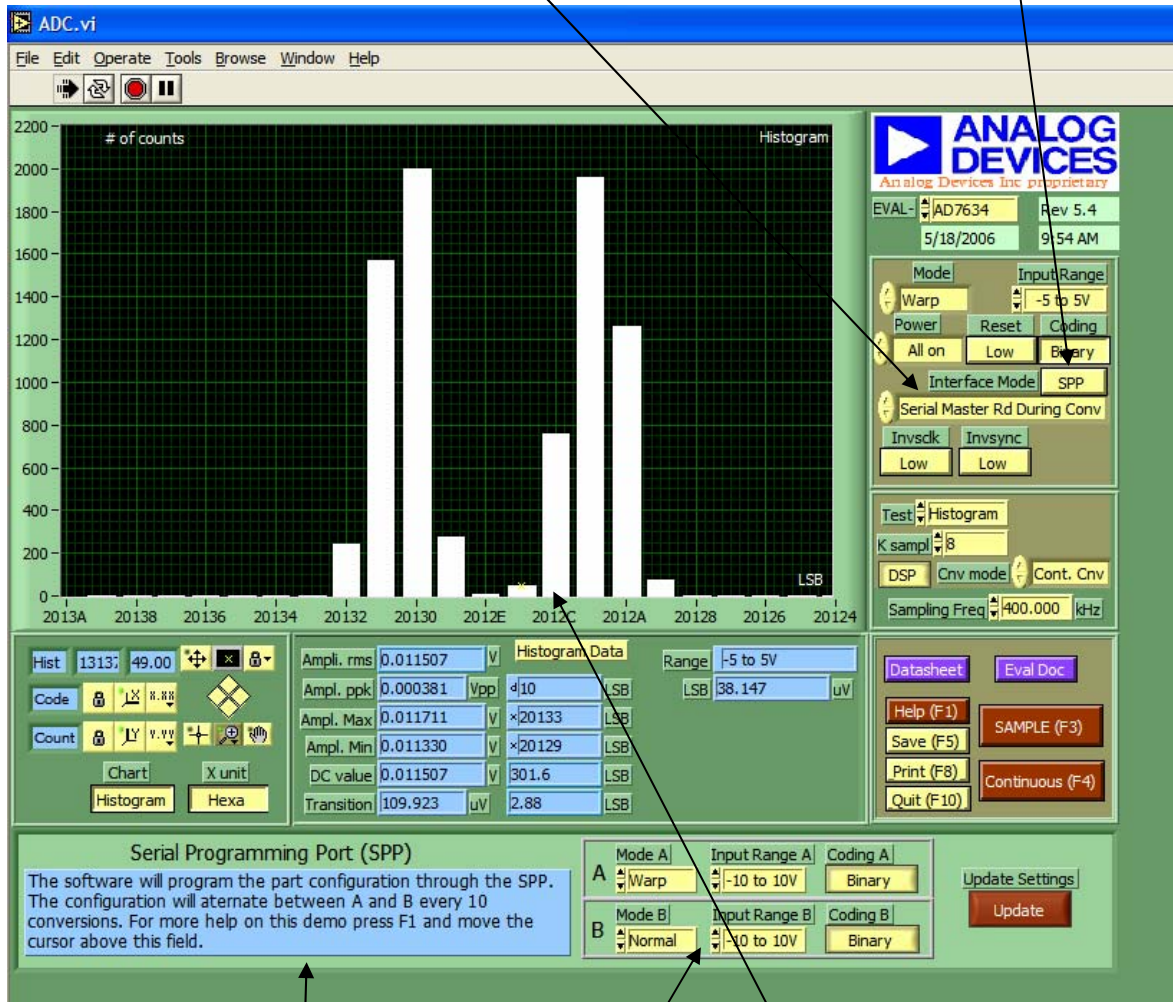

As per this informative description, the software will collect data every ten samples from the two sets of data entered in the "A" and "B" configurations through the Serial Programmable Serial Port (SPP).

The results are displayed here for the two different configurations. This particular example is showing the bipolar zero error difference between warp and and normal modes.

Figure 16. Serial Programmable Port (SPP) Demo Screen

**ORDERING INFORMATION****ORDERING GUIDE**

<b>Evaluation Board Model</b>	<b>Product</b>
EVAL-AD7610CB	AD7610ASTZ/ACPZ
EVAL-AD7612CB	AD7612ASTZ/ACPZ
EVAL-AD7621CB	AD7621AST/ACP
EVAL-AD7622CB	AD7622BSTZ/BCPZ
EVAL-AD7623CB	AD7623AST/ACP
EVAL-AD7631CB	AD7631ASTZ/ACPZ
EVAL-AD7634CB	AD7634ASTZ/ACPZ
EVAL-AD7641CB	AD7641BSTZ/BCPZ
EVAL-AD7643CB	AD7643BSTZ/BCPZ
EVAL-AD7650CB	AD7650AST/ACP
EVAL-AD7651CB	AD7651AST/ACP
EVAL-AD7652CB	AD7652AST/ACP
EVAL-AD7653CB	AD7653AST/ACP
EVAL-AD7654CB	AD7654AST/ACP
EVAL-AD7655CB	AD7655AST/ACP
EVAL-AD7660CB	AD7660AST/ACP
EVAL-AD7661CB	AD7661AST/ACP
EVAL-AD7663CB	AD7663AST/ACP
EVAL-AD7664CB	AD7664AST/ACP
EVAL-AD7665CB	AD7665AST/ACP
EVAL-AD7666CB	AD7666AST/ACP
EVAL-AD7667CB	AD7667AST/ACP
EVAL-AD7671CB	AD7671AST/ACP
EVAL-AD7674CB	AD7674AST/ACP
EVAL-AD7675CB	AD7675AST/ACP
EVAL-AD7676CB	AD7676AST/ACP
EVAL-AD7677CB	AD7677AST/ACP
EVAL-AD7678CB	AD7678AST/ACP
EVAL-AD7679CB	AD7679AST/ACP
EVAL-AD7951CB	AD7951ASTZ/ACPZ
EVAL-CONTROL BRD2 <sup>1</sup>	Controller Board
EVAL-CONTROL BRD3	Controller Board

---

<sup>1</sup> Not in production any longer.

**NOTES**