



DR22 SERIES | AC OUTPUT

DIN RAIL MOUNT SOLID STATE RELAYS



Features

- Output ratings up to 35 Amps at 600 VAC
- Built-in overvoltage protection
- Relay or Contactor configuration
- Integral heat sink eliminates the need for complex thermal calculations
- DBC substrate for superior thermal performance
- "Elevator" screw option to allow the use of ring or lug type terminals
- IP20 touch-safe housing
- AC or DC control
- C-UL-US and TUV approved



PRODUCT SELECTION

Control Voltage	20 A	30 A	35 A
90-280 VAC/VDC	DR2260A20x	DR2260A30x	DR2260A35x
4-32 VDC	DR2260D20x	DR2260D30x	DR2260D35x



SPECIFICATIONS

Output ⁽²⁾

Description	20 A	30 A	35 A
Operating Voltage (47-440Hz) [Vrms]	48-600	48-600	48-600
Transient Overvoltage [Vpk] ³	1200	1200	1200
Maximum Off-State Leakage Current @ Rated Voltage [mArms]	1	1	1
Minimum Off-State dv/dt @ Maximum Rated Voltage [V/μsec]	500	500	500
Load Current, General Use UL508/LC A IEC 62314 @ 40°C [Arms]	20	30	35
Load Current, Motor Starting UL508 FLA/LC B IEC 62314 @ 40°C [Arms]	8.5/4.8	14/7.6	26/14
Minimum Load Current [mArms]	100	100	150
Maximum 1 Cycle Surge Current (50/60Hz) [Apk]	286/300	716/750	1290/1350
Maximum On-State Voltage Drop @ Rated Current [Vpk]	1.35	1.35	1.30
Maximum 1/2 Cycle I ² t for Fusing (50/60Hz) [A ² sec]	409/375	2563/2343	8320/7593
Minimum Power Factor (at Maximum Load) ⁴	0.5	0.5	0.5
Motor Rating UL 508/IEC62314 [HP (kW)]: 120 VAC	0.5 (0.37)	1 (0.74)	2 (1.5)
Motor Rating UL 508/IEC62314 [HP (kW)]: 240 VAC	1.5 (1.1)	3 (2.2)	5 (3.73)
Motor Rating UL 508/IEC62314 [HP (kW)]: 480 VAC	3 (2.24)	5 (3.7)	10 (7.4)

Input ⁽²⁾

Description	DR2260Dxxx	DR2260Axxx
Control Voltage Range	4-32 VDC ⁵	90-280 VAC/VDC ⁶
Maximum Reverse Voltage	-32 VDC	-
Minimum Turn-On Voltage	4 VDC	90 VAC/VDC
Must Turn-Off Voltage	1 VDC	5 VAC/VDC
Minimum Input Current (for on-state)	7 mA	6 mA
Maximum Input Current	15 mA	10 mA
Nominal Input Impedance	Current Regulated	Current Limited
Maximum Turn-On Time [msec]	1/2 Cycle ⁷	20
Maximum Turn-Off Time [msec]	1/2 Cycle	30

General ⁽²⁾

Description	Parameters
Dielectric Strength, Input to Output (50/60Hz)	4000 Vrms
Dielectric Strength, Input/Output to Case (50/60Hz)	4000 Vrms
Minimum Insulation Resistance (@ 500 VDC)	10 ⁹ Ohms
Maximum Capacitance, Input/Output	8 pF
Ambient Operating Temperature Range ⁸	-40 to 80 °C
Ambient Storage Temperature Range	-40 to 100 °C
Short Circuit Current Rating ⁹	100kA
Weight (typical)	Option "U" 10.5 oz (298 g), Option "V","W" 10.6 oz (301 g)
Housing Material	UL94 V-0
Heat Sink Material	Aluminum
Din Rail Clip Material	Zink Plated Steel
Hardware Finish	Nickel Plating
Input Terminal Screw Torque Range (lb-in/Nm)	Option "U" 13-15/1.5-1.7, Option "V","W" 5/0.5 ¹⁰
Load Terminal Screw Torque Range (lb-in/Nm)	Option "U" 13-15/1.5-1.7, Option "V","W" 18-20/2-2.2
Humidity	95% non-condensing
LED Input Status Indicator	Green



INPUT CURRENT INFORMATION

4-32 VDC Input

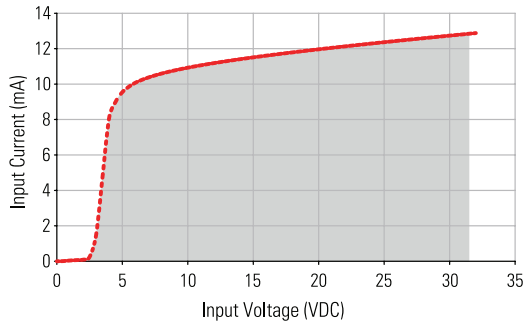

90-280 VAC/VDC Input

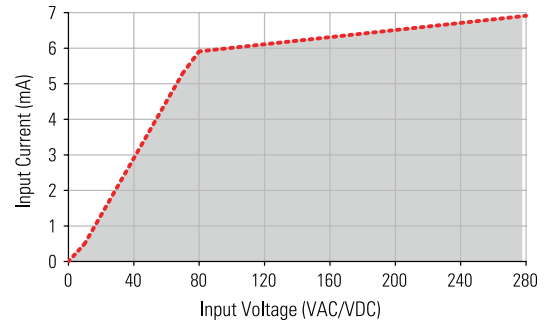

SURGE CURRENT INFORMATION

DR2260x20x

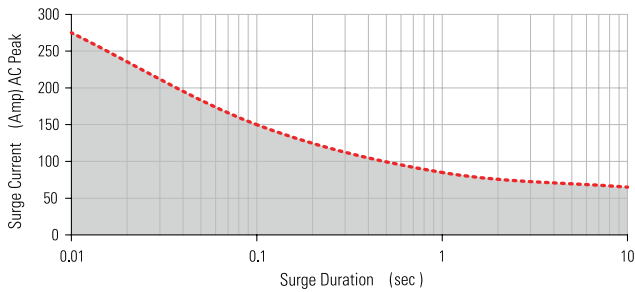

DR2260x30x

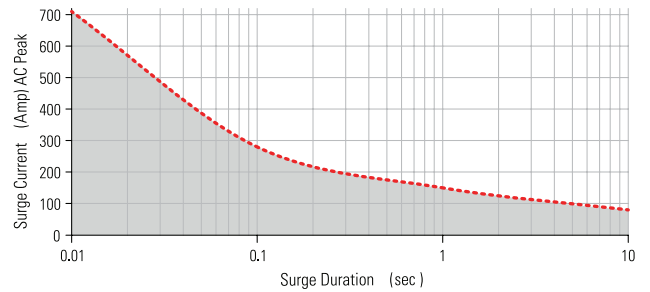

DR2260x35x

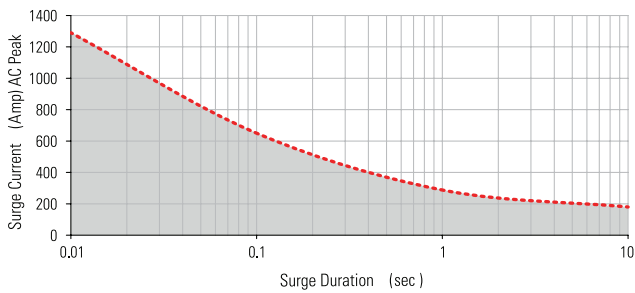

--- Single Pulse 11



THERMAL DERATE INFORMATION ⁸

DR2260x20x

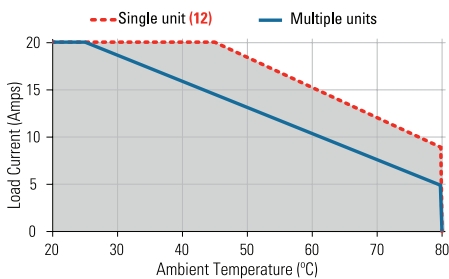

DR2260x30x

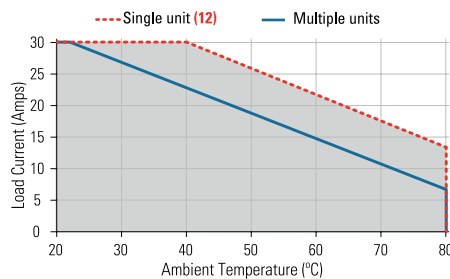

DR2260x35x

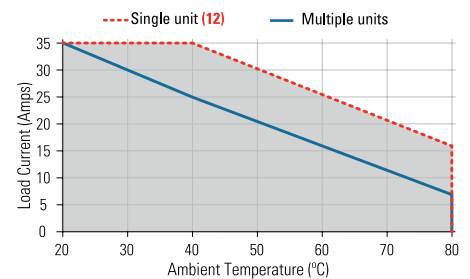



EQUIVALENT CIRCUIT BLOCK DIAGRAMS/WIRING DIAGRAM

DC Control

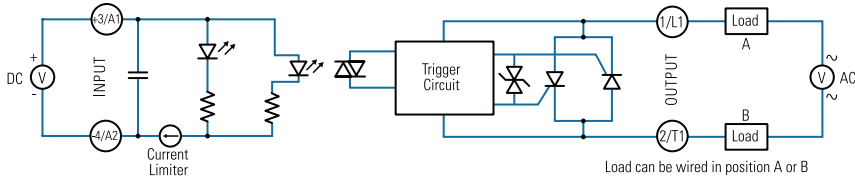

AD/DC Control

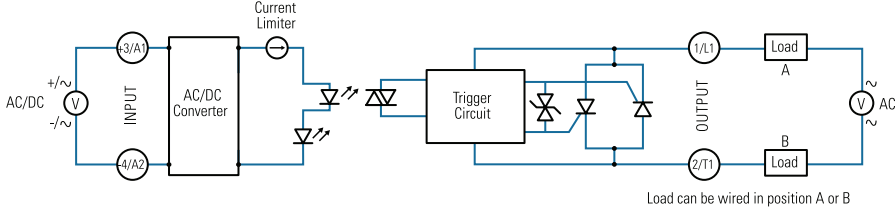

Recommended Wire Sizes

Terminal Configuration	Wire Size (Solid / Stranded)	Wire Pull-Out Strength (lbs)[N]	
Output¹³ Relay "U" suffix	2 x 18 AWG (1 mm ²) Stranded	20 [88]	
	2 x 10 AWG (6 mm ²) Stranded	60 [266]	
Input Relay "U" suffix	2 x 18 AWG (1 mm ²) Stranded	20 [88]	
	2 x 12 AWG (4 mm ²) Stranded	40 [177]	
Output Contactor "V" & "W" suffixes	2 x 20 AWG (0.75 mm ²) [minimum]	25 [111]	
	2 x 10 AWG (6 mm ²)	80 [355]	
	2 x 8 AWG (10 mm ²) [maximum]	90 [400]	
Input Contactor "V" & "W" suffixes	Screw	30 AWG (0.05 mm ²) [minimum]	4.5 [20]
		12 AWG (3.3 mm ²) [maximum]	30 [133]
	Spring	26 AWG (0.13 mm ²) [minimum]	5 [22]
		12 AWG (3.3 mm ²) [maximum]	5 [22]



MECHANICAL SPECIFICATIONS

*Tolerances: ±0.02 in / 0.5 mm All dimensions are in: inches [millimeters]

Contactor Configuration

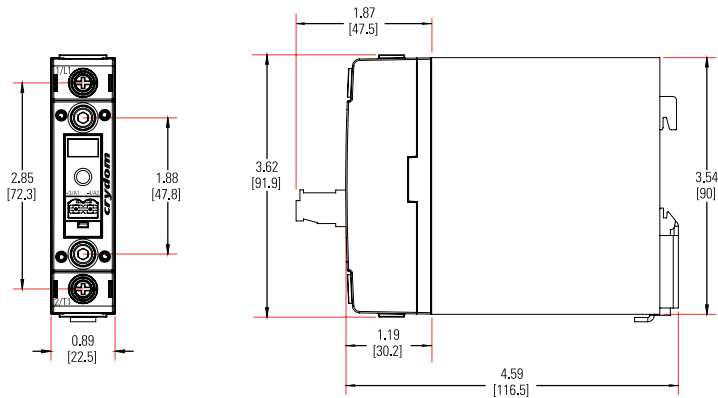

Relay Configuration

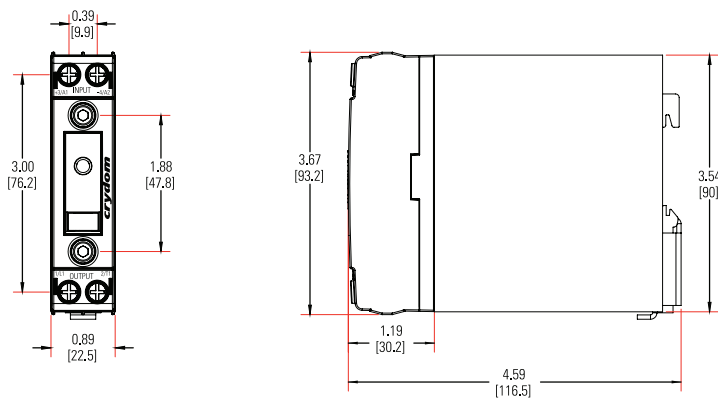

Input Connector

	Screw Terminal
	Spring Terminal

Protective Earth Connection

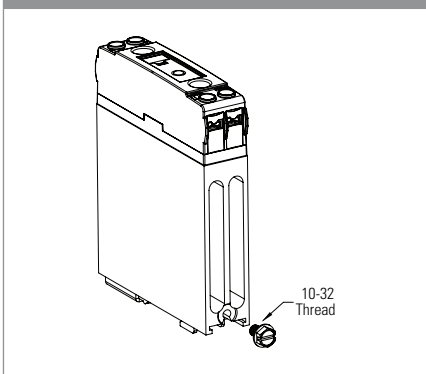

Protective Earth (PE) screw type recommended is 10-32 UNC standard not provided with SSR. Through the use of a DIN rail ground (protective conductor) terminal block, the DIN rail itself can be used as the grounding bus bar. In this case, the zinc plated steel material used for the DIN rail clip of DR22 models, permits a secure path to ground and avoid the need of a further PE connection.

TABLE 1. Compatible Terminals

Terminals				
Terminals	Fork Lug	Ring Lug	Copper Lug	Copper Lug
Crydom Part No.			TRM0	TRM6
Width [W] in (mm)	0.45 (11.4)	0.45 (11.4)		
Stud Size Dia [D] (in)	#8 (0.168)	#8 (0.168)		
Wire Size AWG			6-0	14-6

Elevator Screw (Suffix 'W')

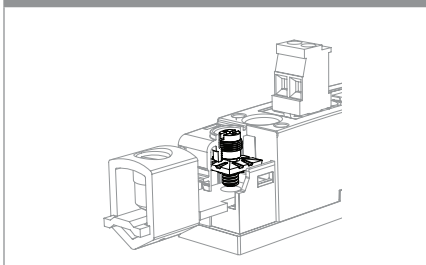

The Elevator Screw option allows the screw and clamp to be raised out of the mating threads completely. This provides for the insertion and use of a ring or lug type wire terminal. Refer to TABLE 1 for Compatible Terminals.



ORDERING OPTIONS

Example : DR2260A20VRJ

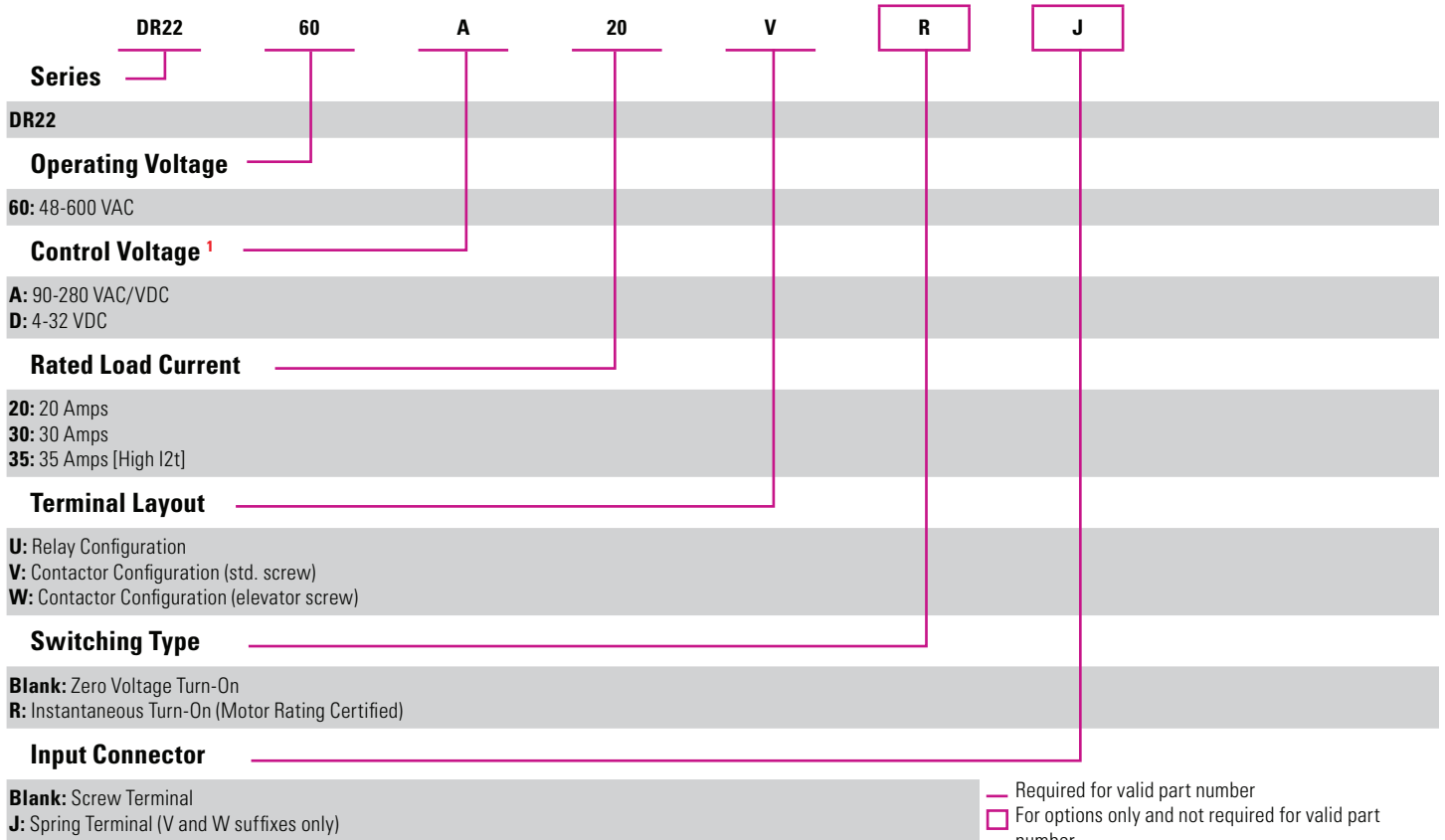



GENERAL NOTES

- (1) Control voltage 18-52 VAC/VDC is available upon request.
- (2) All parameters at 25°C unless otherwise specified.
- (3) Output will self trigger between 900-1200 Vpk, not suitable for capacitive loads.
- (4) High inductive loads requires nominal control voltage; AC input models only.
- (5) Increase minimum voltage by 1 V for operations from -20 to -40°C.
- (6) For ambient temperatures above 40°C the maximum control voltage must not exceed 250 VAC/VDC.
- (7) Turn-on time for Instantaneous turn-on versions is 0.1 msec.
- (8) AC input models operating range is -20 to 60 °C.
- (9) When protected with the appropriate class and rated fuse. For detailed info please contact Crydom Technical Support.
- (10) Input torque only for contactor (V,W) with screw terminals Connector.
- (11) For single surge pulse Tc=25°C; Tj=125°C. For AC Output SSRs, AC RMS value of surge current equals the peak value divided by 2 (1.414).
- (12) Minimum spacing to obtain max. current is 22.5mm between adjacent units.
- (13) For 35 Amp Relay ("U") layout models, use Pin Terminals (L 0.410 in x Ø 0.102 in) to install 8 AWG wire.
- (14) Applicable to Relay ("U") option.
- (15) Test made with a unit fixed between DIN RAIL Stoppers. Multiple devices mounted close each other, results may vary.

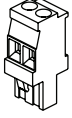
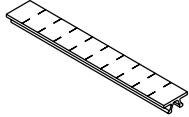
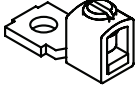

Recommended Accessories		
		
Connectors	ID Marker	Lug Terminal
CP201 CP202	CNLB CNLN CNL2	TRM0 TRM6

Connectors Part number: CP201, CP202		Lug Terminal Part number: TRM0	
	Pluggable input connectors, 2 position, with screw terminals (CP201) or spring type terminals (CP202). Compatible with Contactor configuration NOVA22 SSRs.		Copper wire lug for AWG 6 (13.3 mm ²) to AWG 0 (53.5 mm ²) wire size. For use with "Elevator" screw option ("W" suffix) NOVA22 SSRs.

AGENCY APPROVALS & CERTIFICATIONS

Certification in accordance with:
 United States Standard for Industrial Control Equipment - UL 508 and Canadian Standard Association for Industrial Control Equipment – C22.2 No. 14.

TUV Certified in accordance to EN62314

Vibration Resistance:¹⁵
 IEC 60068-2-6: Amplitude Range 10-500 Hz, Displacement 0.75mm

Shock Resistance:¹⁵
 IEC 60068-2-27: Peak Acceleration 50g, Duration 11ms.



Electromagnetic Compatibility				
Generic Standard	Immunity Tests	Test Specification Level	Performance	
IEC 61000-6-2 Immunity for Industrial Environments	Electrostatic Discharge IEC 61000-4-2	8kV air discharge	Criterion B	
		6kV contact discharge	Criterion A	
	Fast transients (burst) IEC 61000-4-4	Output	2kV, 5kHz, 100kHz	Criterion B
		Input	1kV, 5kHz, 100kHz	Criterion B
	Surge IEC 61000-4-5	Output	1kV Line to Earth	Criterion B
			2kV Line to Earth	Criterion B
		AC Input Option	1kV Line to Earth	Criterion B
			2kV Line to Earth	Criterion B

WARNINGS



RISK OF MATERIAL DAMAGE AND HOT ENCLOSURE

- The product's side panels may be hot, allow the product to cool before touching
- Follow proper mounting instructions including torque values
- Do not allow liquids or foreign objects to enter this product

Failure to follow these instructions can result in serious injury, or equipment damage.



HAZARD OF ELECTRIC SHOCK, EXPLOSION OR ARC FLASH

- Disconnect all power before installing or working with this equipment
- Verify all connections and replace all covers before turning on power

Failure to follow these instructions will result in death or serious injury.

Sensata Technologies, Inc. ("Sensata") data sheets are solely intended to assist designers ("Buyers") who are developing systems that incorporate Sensata products (also referred to herein as "components"). Buyer understands and agrees that Buyer remains responsible for using its independent analysis, evaluation and judgment in designing Buyer's systems and products. Sensata data sheets have been created using standard laboratory conditions and engineering practices. Sensata has not conducted any testing other than that specifically described in the published documentation for a particular data sheet. Sensata may make corrections, enhancements, improvements and other changes to its data sheets or components without notice.

Buyers are authorized to use Sensata data sheets with the Sensata component(s) identified in each particular data sheet. HOWEVER, NO OTHER LICENSE, EXPRESS OR IMPLIED, BY ESTOPPEL OR OTHERWISE TO ANY OTHER SENSATA INTELLECTUAL PROPERTY RIGHT, AND NO LICENSE TO ANY THIRD PARTY TECHNOLOGY OR INTELLECTUAL PROPERTY RIGHT, IS GRANTED HEREIN. SENSATA DATA SHEETS ARE PROVIDED "AS IS". SENSATA MAKES NO WARRANTIES OR REPRESENTATIONS WITH REGARD TO THE DATA SHEETS OR USE OF THE DATA SHEETS, EXPRESS, IMPLIED OR STATUTORY, INCLUDING ACCURACY OR COMPLETENESS. SENSATA DISCLAIMS ANY WARRANTY OF TITLE AND ANY IMPLIED WARRANTIES OF MERCHANTABILITY, FITNESS FOR A PARTICULAR PURPOSE, QUIET ENJOYMENT, QUIET POSSESSION, AND NON-INFRINGEMENT OF ANY THIRD PARTY INTELLECTUAL PROPERTY RIGHTS WITH REGARD TO SENSATA DATA SHEETS OR USE THEREOF.

All products are sold subject to Sensata's terms and conditions of sale supplied at www.sensata.com SENSATA ASSUMES NO LIABILITY FOR APPLICATIONS ASSISTANCE OR THE DESIGN OF BUYERS' PRODUCTS. BUYER ACKNOWLEDGES AND AGREES THAT IT IS SOLELY RESPONSIBLE FOR COMPLIANCE WITH ALL LEGAL, REGULATORY AND SAFETY-RELATED REQUIREMENTS CONCERNING ITS PRODUCTS, AND ANY USE OF SENSATA COMPONENTS IN ITS APPLICATIONS, NOTWITHSTANDING ANY APPLICATIONS-RELATED INFORMATION OR SUPPORT THAT MAY BE PROVIDED BY SENSATA.

Mailing Address: Sensata Technologies, Inc., 529 Pleasant Street, Attleboro, MA 02703, USA.

CONTACT US

Americas

+1 (877) 502 5500
sales.crydom@sensata.com
Europe, Middle East & Africa
 +44 (1202) 416170
ssr-info.eu@sensata.com

Asia Pacific

sales.isasia@list.sensata.com
 China +86 (21) 2306 1500
 Japan +81 (45) 277 7117
 Korea +82 (31) 601 2004
 India +91 (80) 67920890
 Rest of Asia +886 (2) 27602006
 ext 2808