



FH105A

RF Transistor 10V, 30mA, $f_T=8\text{GHz}$, NPN Dual MCP6

ON Semiconductor®

<http://onsemi.com>

Features

- Composite type with 2 transistors contained in the MCP package currently in use, improving the mounting efficiency greatly
- The FH105A is formed with two chips, being equivalent to the 2SC5245A, placed in one package
- Optimal for differential amplification due to excellent thermal equilibrium and pair capability

Specifications

Absolute Maximum Ratings at $T_a=25^\circ\text{C}$

Parameter	Symbol	Conditions	Ratings	Unit
Collector-to-Base Voltage	V_{CBO}		20	V
Collector-to-Emitter Voltage	V_{CEO}		10	V
Emitter-to-Base Voltage	V_{EBO}		1.5	V
Collector Current	I_C		30	mA
Collector Dissipation	P_C	When mounted on ceramic substrate (250mm ² ×0.8mm) 1unit	150	mW
Total Power Dissipation	P_T	When mounted on ceramic substrate (250mm ² ×0.8mm)	300	mW
Junction Temperature	T_j		150	°C
Storage Temperature	T_{stg}		-55 to +150	°C

Stresses exceeding Maximum Ratings may damage the device. Maximum Ratings are stress ratings only. Functional operation above the Recommended Operating Conditions is not implied. Extended exposure to stresses above the Recommended Operating Conditions may affect device reliability.

Package Dimensions

unit : mm (typ)

7026A-005

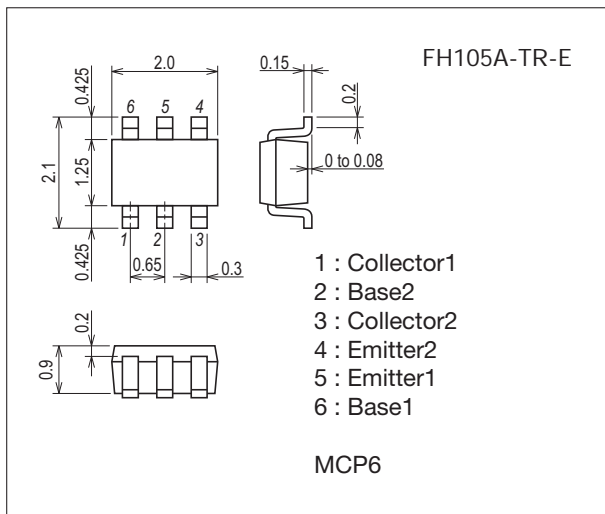

Product & Package Information

- Package : MCP6
- JEITA, JEDEC : SC-88, SC-70-6, SOT-363
- Minimum Packing Quantity : 3,000 pcs./reel

Packing Type : TR

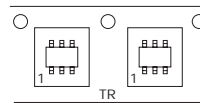

Marking

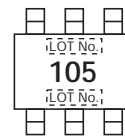

Electrical Connection

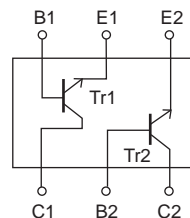

FH105A

Electrical Characteristics at Ta=25°C

Parameter	Symbol	Conditions	Ratings			Unit
			min	typ	max	
Collector Cutoff Current	I_{CBO}	$V_{CB}=10V, I_E=0A$			1.0	μA
Emitter Cutoff Current	I_{EBO}	$V_{EB}=1V, I_C=0A$			10	μA
DC Current Gain	h_{FE}	$V_{CE}=5V, I_C=10mA$	90		200	
DC Current Gain Ratio	$h_{FE(small/large)}$	$V_{CE}=5V, I_C=10mA$	0.7	0.95		
Base-to-Emitter Voltage Difference	$V_{BE(large-small)}$	$V_{CE}=5V, I_C=10mA$		1.0		mV
Gain-Bandwidth Product	f_T	$V_{CE}=5V, I_C=10mA$	5	8		GHz
Output Capacitance	C_{ob}	$V_{CB}=10V, f=1MHz$		0.45	0.7	pF
Forward Transfer Gain	$ S_{21e} ^2$	$V_{CE}=5V, I_C=10mA, f=1.5GHz$	8	10		dB
Noise Figure	NF	$V_{CE}=5V, I_C=5mA, f=1.5GHz$		1.4	3.0	dB

Note) The specifications shown above are for each individual transistor except the $h_{FE(small/large)}$ and $V_{BE(large-small)}$ for which pair capability is also shown.

Ordering Information

Device	Package	Shipping	memo
FH105A-TR-E	MCP6	3,000pcs./reel	Pb Free

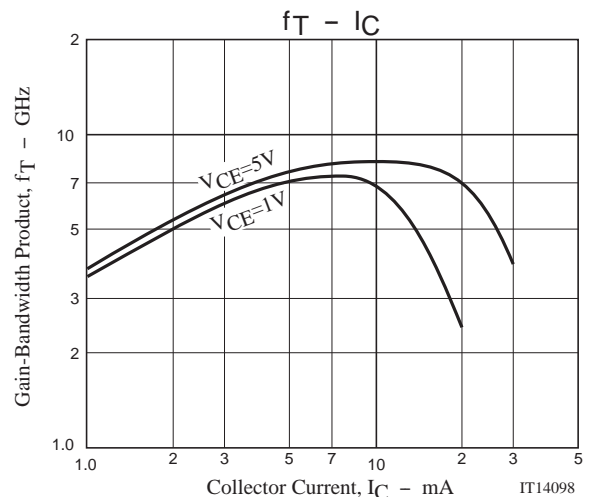
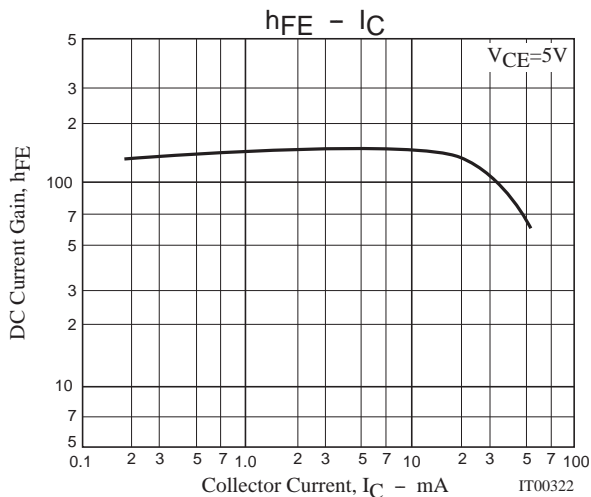

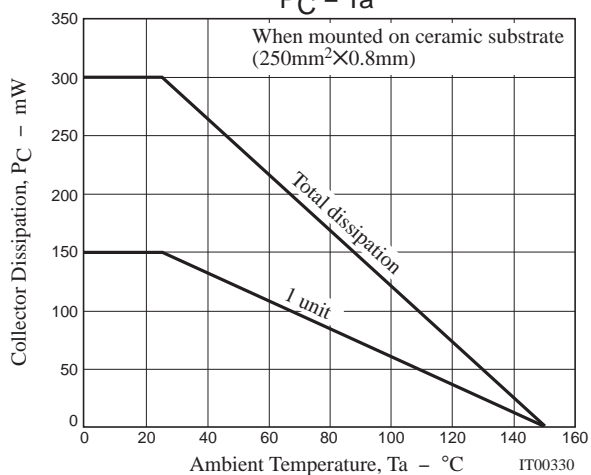
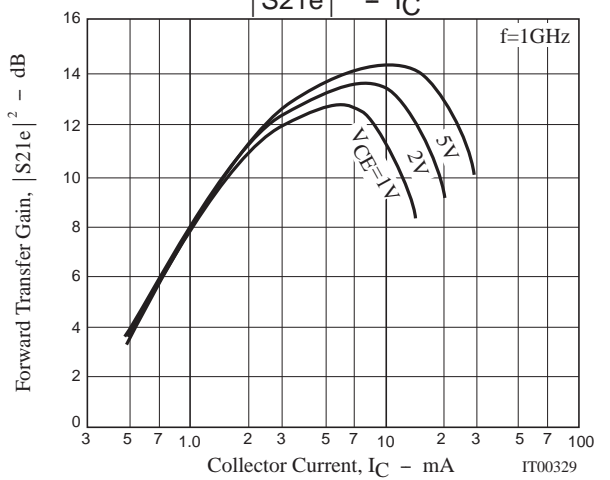
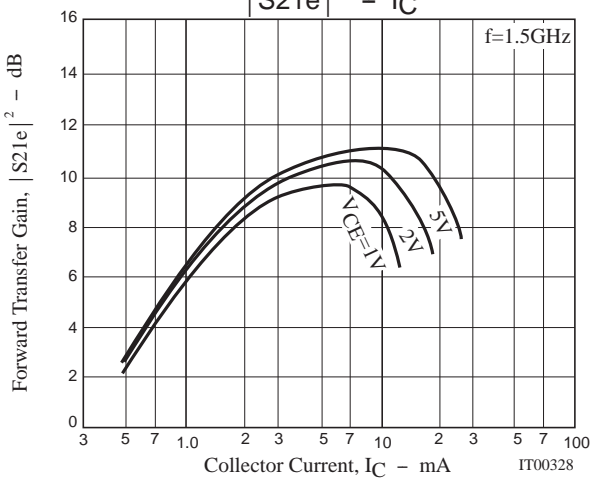
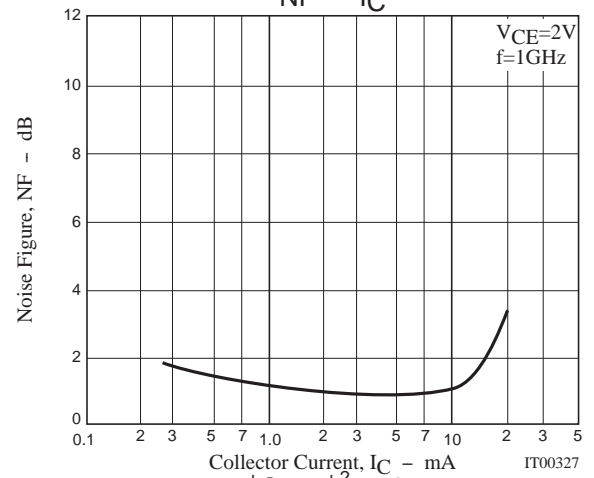
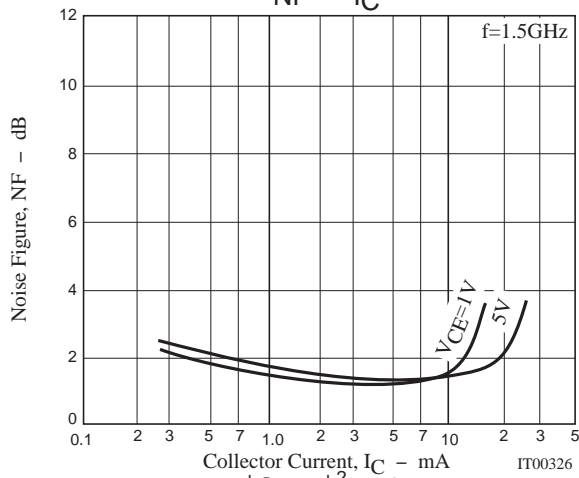
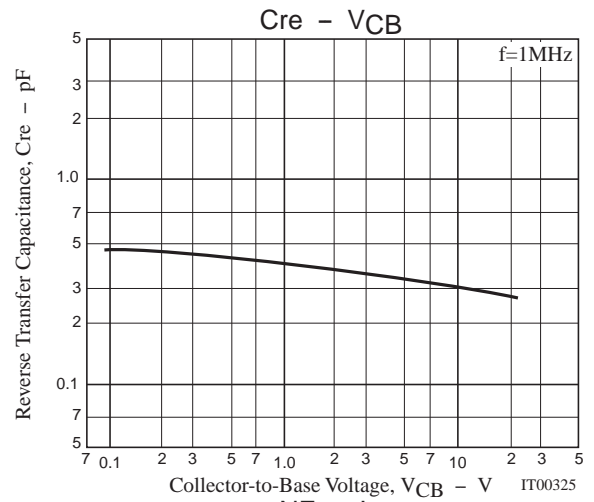
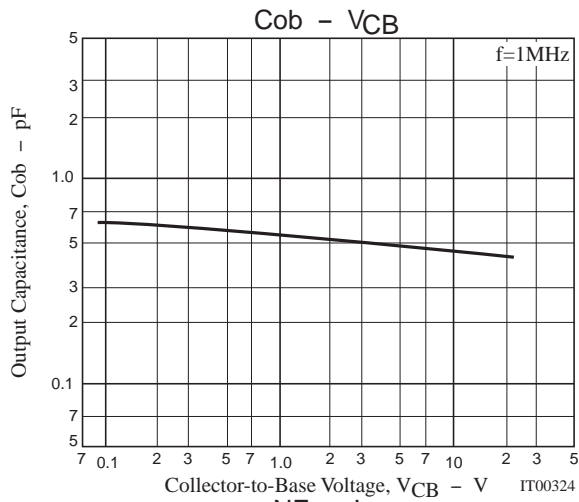

S Parameter

S11e

f=200MHz to 2000MHz(200MHz Step)

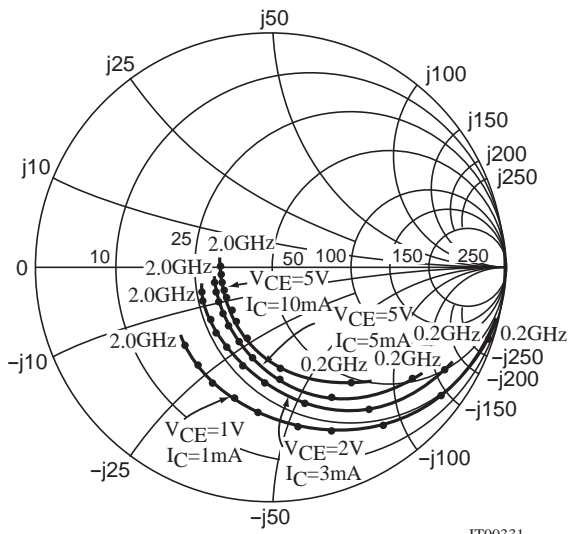

IT00331

S21e

f=200MHz to 2000MHz(200MHz Step)

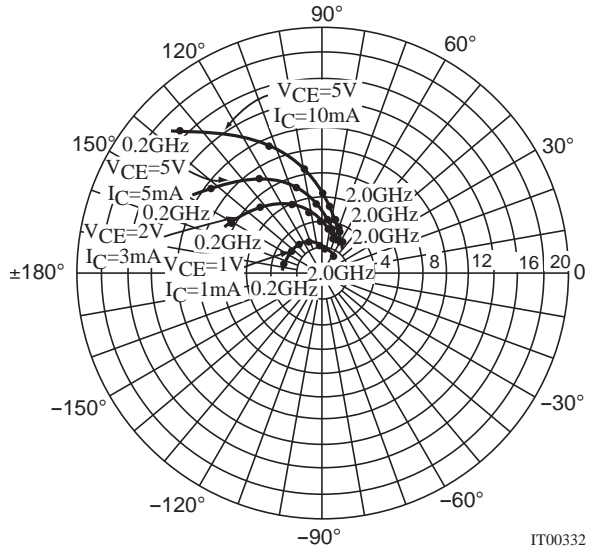

IT00332

S12e

f=200MHz to 2000MHz(200MHz Step)

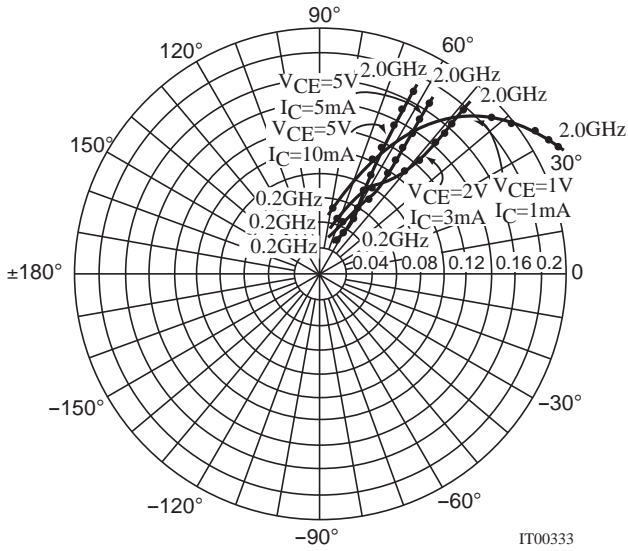

IT00333

S22e

f=200MHz to 2000MHz(200MHz Step)

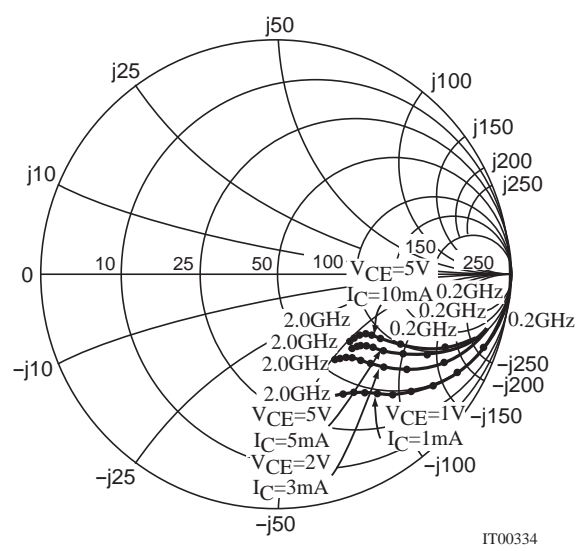

IT00334

FH105A

S Parameters (Common emitter)

$V_{CE}=5V, I_C=5mA, Z_O=50\Omega$

Freq(MHz)	S11	$\angle S11$	S21	$\angle S21$	S12	$\angle S12$	S22	$\angle S22$
200	0.763	-37.5	11.926	146.9	0.036	70.7	0.892	-19.1
400	0.590	-65.4	9.202	124.3	0.058	60.9	0.740	-29.1
600	0.456	-85.5	7.173	109.4	0.073	57.4	0.631	-33.7
800	0.374	-102.0	5.743	98.7	0.086	56.7	0.566	-35.8
1000	0.323	-115.0	4.785	90.5	0.098	56.7	0.528	-37.2
1200	0.288	-127.5	4.105	83.6	0.110	57.2	0.505	-38.4
1400	0.264	-137.7	3.599	77.5	0.123	57.7	0.488	-39.6
1600	0.248	-147.4	3.213	71.3	0.136	57.6	0.476	-41.2
1800	0.239	-156.9	2.905	66.4	0.150	57.6	0.466	-43.3
2000	0.235	-165.7	2.651	61.3	0.165	57.2	0.462	-45.4

$V_{CE}=5V, I_C=10mA, Z_O=50\Omega$

Freq(MHz)	S11	$\angle S11$	S21	$\angle S21$	S12	$\angle S12$	S22	$\angle S22$
200	0.605	-52.6	16.354	136.2	0.031	67.5	0.804	-23.9
400	0.417	-84.6	11.011	113.3	0.048	62.4	0.622	-30.5
600	0.319	-106.3	8.026	100.5	0.062	62.2	0.533	-32.0
800	0.266	-124.6	6.250	91.3	0.076	63.4	0.491	-32.4
1000	0.238	-136.5	5.115	84.7	0.090	64.3	0.469	-33.2
1200	0.225	-148.9	4.336	78.8	0.104	64.4	0.458	-34.6
1400	0.215	-158.3	3.813	73.4	0.119	64.5	0.449	-35.8
1600	0.213	-167.3	3.365	68.1	0.135	63.8	0.443	-37.7
1800	0.212	-175.6	3.030	63.5	0.150	63.1	0.436	-39.6
2000	0.216	-177.5	2.754	58.9	0.166	62.5	0.438	-41.9

$V_{CE}=2V, I_C=3mA, Z_O=50\Omega$

Freq(MHz)	S11	$\angle S11$	S21	$\angle S21$	S12	$\angle S12$	S22	$\angle S22$
200	0.842	-30.7	8.491	153.0	0.044	72.5	0.931	-17.1
400	0.704	-56.3	7.161	131.9	0.075	60.9	0.808	-28.8
600	0.579	-76.1	5.879	116.3	0.095	54.1	0.696	-36.2
800	0.480	-93.1	4.882	104.2	0.109	51.0	0.615	-40.6
1000	0.417	-106.3	4.154	95.0	0.121	49.3	0.564	-43.5
1200	0.376	-119.6	3.597	87.1	0.132	48.7	0.526	-45.8
1400	0.343	-130.2	3.212	80.2	0.143	48.6	0.496	-47.5
1600	0.319	-140.5	2.875	73.4	0.154	48.7	0.475	-49.6
1800	0.303	-150.0	2.604	67.7	0.166	48.6	0.461	-51.6
2000	0.298	-160.0	2.383	62.1	0.179	48.9	0.451	-52.9

$V_{CE}=1V, I_C=1mA, Z_O=50\Omega$

Freq(MHz)	S11	$\angle S11$	S21	$\angle S21$	S12	$\angle S12$	S22	$\angle S22$
200	0.945	-18.9	3.296	162.5	0.054	77.2	0.980	-11.0
400	0.884	-37.3	3.206	145.9	0.102	65.9	0.934	-20.5
600	0.810	-53.6	2.942	131.2	0.139	56.3	0.870	-29.0
800	0.728	-69.4	2.711	117.8	0.166	48.6	0.811	-35.5
1000	0.667	-82.5	2.449	107.0	0.187	42.5	0.763	-40.9
1200	0.605	-95.8	2.252	96.9	0.199	37.3	0.715	-45.7
1400	0.561	-106.1	2.061	88.1	0.207	33.5	0.673	-49.4
1600	0.518	-117.2	1.909	79.5	0.212	30.6	0.638	-53.4
1800	0.492	-127.5	1.766	72.2	0.215	28.6	0.611	-56.5
2000	0.465	-137.9	1.658	65.2	0.217	27.6	0.592	-59.9

Embossed Taping Specification

FH105A-TR-E

Storage package Outline name	Carrier tape Type number	Maximum Number of devices contained (pcs.)			Packing format	
		Reel	Inner box	Outer box	Inner box BOX (C-1)	Outer box BOX (A-7)
MCP 6	MCP 6	3,000	15,000	90,000	5 reels contained Dimensions:mm(external) 1 8 3 × 7 2 × 1 8 5	6 inner boxes contained Dimensions:mm(external) 4 4 0 × 1 9 5 × 2 1 0

1. Packing format

Packing method

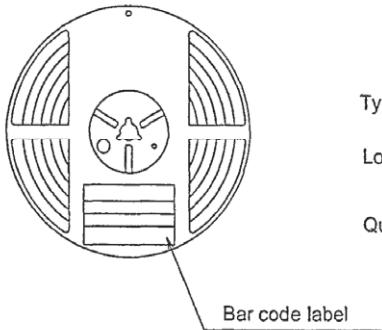

Bar code label

(Unit : mm)

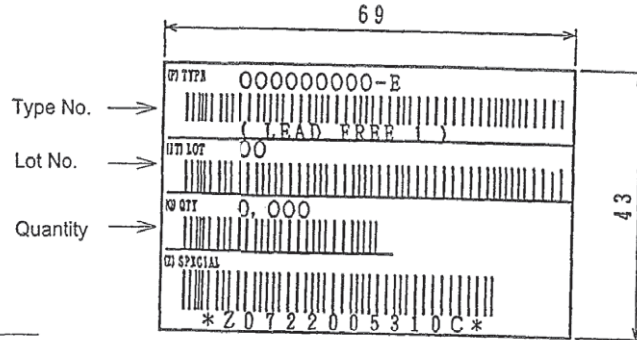

* LEAD FREE 1 :
Lead-free external terminal surface treatment product.

2. Taping structure

2-1. Carrier tape size (Unit : mm)

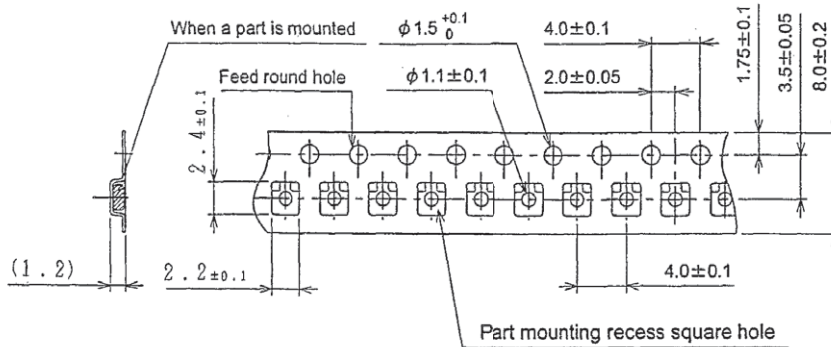

2-2. Parts placement direction

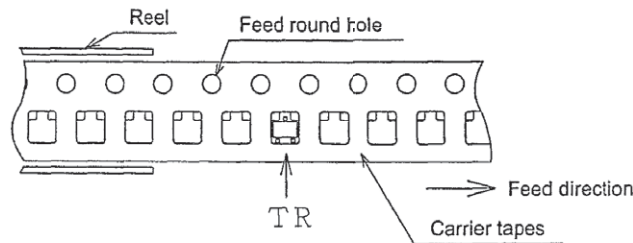

Those with 1 electrode pin on the feed hole side TR

FH105A

Outline Drawing

FH105A-TR-E

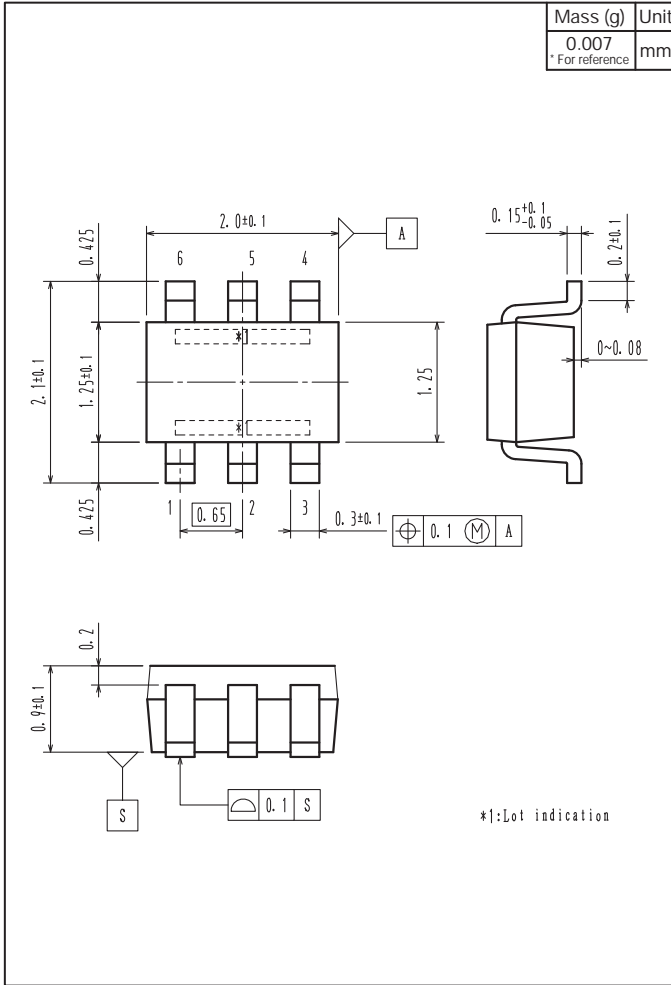

Land Pattern Example

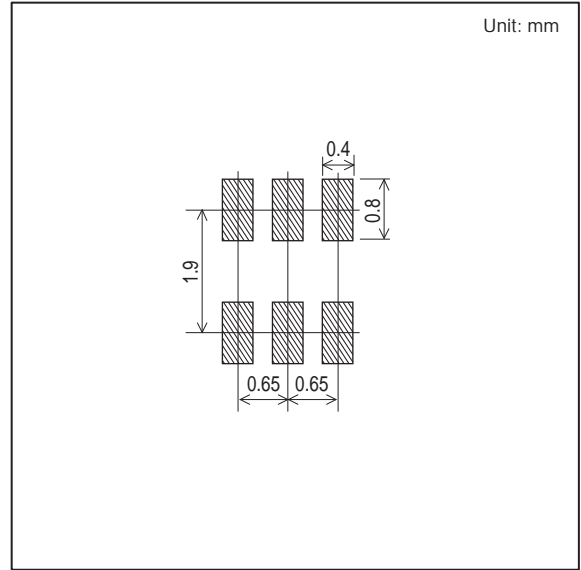

ON Semiconductor and the ON logo are registered trademarks of Semiconductor Components Industries, LLC (SCILLC). SCILLC owns the rights to a number of patents, trademarks, copyrights, trade secrets, and other intellectual property. A listing of SCILLC's product/patent coverage may be accessed at www.onsemi.com/site/pdf/Patent-Marking.pdf. SCILLC reserves the right to make changes without further notice to any products herein. SCILLC makes no warranty, representation or guarantee regarding the suitability of its products for any particular purpose, nor does SCILLC assume any liability arising out of the application or use of any product or circuit, and specifically disclaims any and all liability, including without limitation special, consequential or incidental damages. "Typical" parameters which may be provided in SCILLC data sheets and/or specifications can and do vary in different applications and actual performance may vary over time. All operating parameters, including "Typicals" must be validated for each customer application by customer's technical experts. SCILLC does not convey any license under its patent rights nor the rights of others. SCILLC products are not designed, intended, or authorized for use as components in systems intended for surgical implant into the body, or other applications intended to support or sustain life, or for any other application in which the failure of the SCILLC product could create a situation where personal injury or death may occur. Should Buyer purchase or use SCILLC products for any such unintended or unauthorized application, Buyer shall indemnify and hold SCILLC and its officers, employees, subsidiaries, affiliates, and distributors harmless against all claims, costs, damages, and expenses, and reasonable attorney fees arising out of, directly or indirectly, any claim of personal injury or death associated with such unintended or unauthorized use, even if such claim alleges that SCILLC was negligent regarding the design or manufacture of the part. SCILLC is an Equal Opportunity/Affirmative Action Employer. This literature is subject to all applicable copyright laws and is not for resale in any manner.