

**SINGLE-PHASE GLASS PASSIVATED
SILICON BRIDGE RECTIFIER**
VOLTAGE RANGE 50 to 1000 Volts CURRENT 8.0 Amperes

FEATURES

- * Ideal for printed circuit board
- * Surge overload rating: 250 amperes peak
- * Low leakage
- * Mounting position: Any
- * Low forward voltage
- * High forward surge current capability

MECHANICAL DATA

- * Epoxy: Device has UL flammability classification 94V-0
- * UL listed the recognized component directory, file #94233

MAXIMUM RATINGS AND ELECTRICAL CHARACTERISTICS

Ratings at 25 °C ambient temperature unless otherwise specified.
resistive or inductive load.

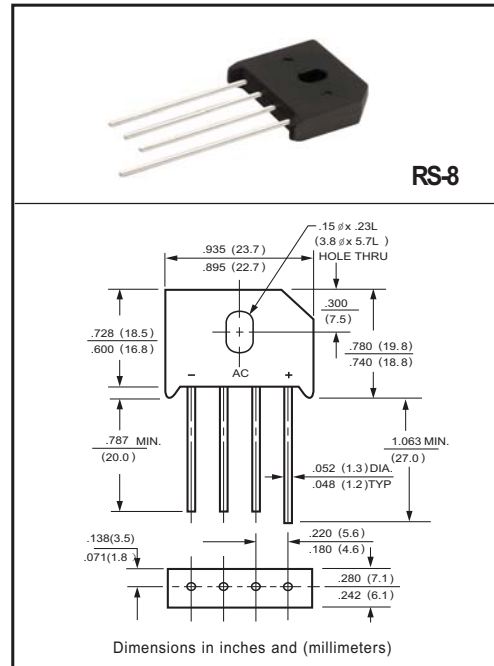

MAXIMUM RATINGS (@ TA=25 °C unless otherwise noted)

RATINGS	SYMBOL	RS801	RS802	RS803	RS804	RS805	RS806	RS807	UNITS
Maximum Recurrent Peak Reverse Voltage	V _{RRM}	50	100	200	400	600	800	1000	Volts
Maximum RMS Voltage	V _{RMS}	35	70	140	280	420	560	700	Volts
Maximum DC Blocking Voltage	V _{DC}	50	100	200	400	600	800	1000	Volts
Maximum Average Forward Rectified Current at T _C = 75°C	I _O	8.0							Amps
Peak Forward Surge Current 8.3 ms single half sine-wave superimposed on rated load (JEDEC method)	I _{FSM}	250							Amps
Current Squared Time	I ² T	259.2							A ² /Sec
Typical Thermal Resistance (Note 1)	R _{θJC}	7							°C/W
	R _{θJA}	18							
Operating and Storage Temperature Range	T _J , T _{STG}	-55 to + 150							°C

ELECTRICAL CHARACTERISTICS (@TA=25 °C unless otherwise noted)

CHARACTERISTICS	SYMBOL	RS801	RS802	RS803	RS804	RS805	RS806	RS807	UNITS	
Maximum Instantaneous Forward Voltage at 8.0A DC	V _F	1.2							Volts	
Maximum DC Reverse Current at Rated DC Blocking Voltage	I _R	@T _A = 25°C	5.0							uAmps
		@T _A = 100°C	200							

- NOTES : 1. Thermal Resistance : Heat-sink case mounted or if PCB mounted.
2. * ROHS compliant*.
3. Measured at 1MHz and applied reverse voltage of 4.0 volts.

RATING AND CHARACTERISTICS CURVES (RS801 THRU RS807)

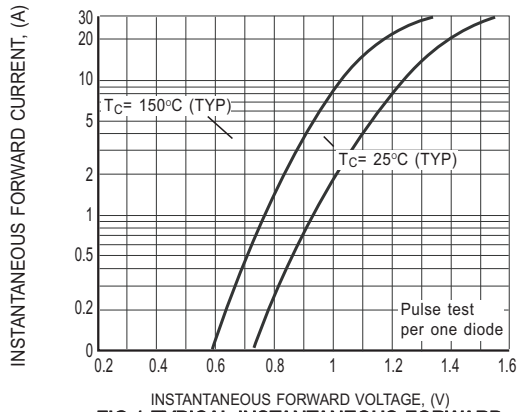

FIG.1 TYPICAL INSTANTANEOUS FORWARD CHARACTERISTICS

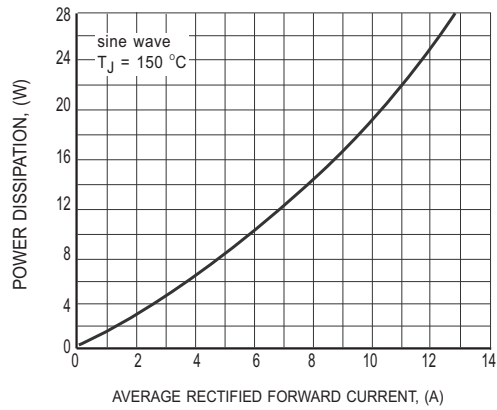

FIG.2 POWER DISSIPATION

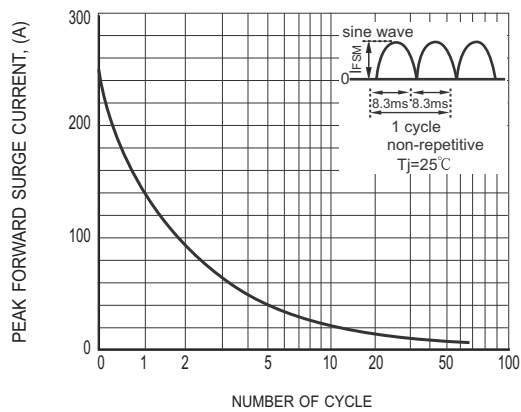

FIG.3 SURGE FORWARD CURRENT CAPABILITY

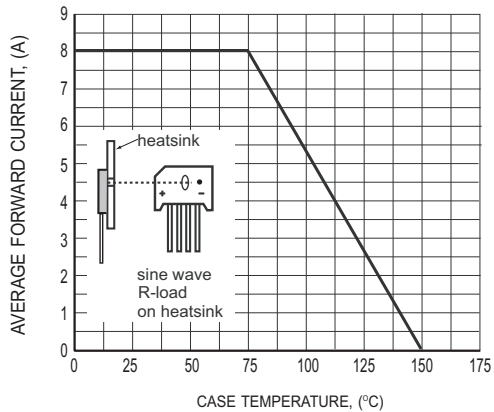

FIG.4 TYPICAL FORWARD CURRENT DERATING CURVE

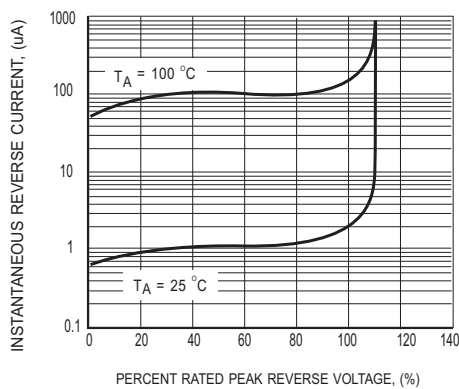
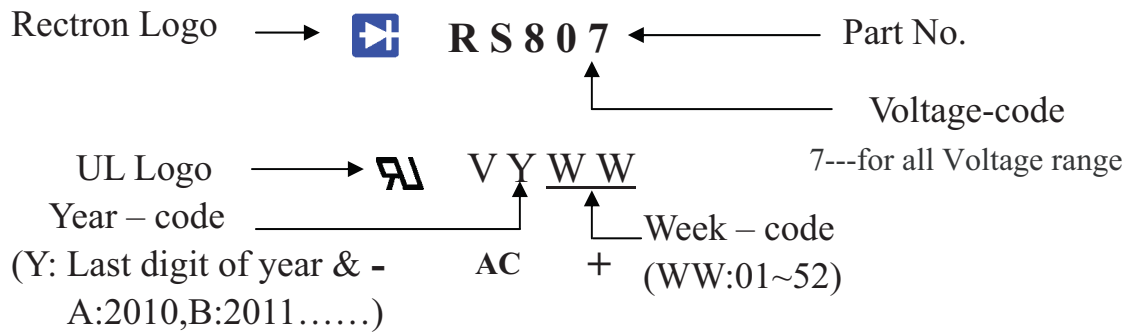

FIG.5 TYPICAL REVERSE CHARACTERISTICS

Marking Description



PACKAGING OF DIODE AND BRIDGE RECTIFIERS

BULK PACK

PACKAGE	PACKING CODE	EA PER BOX	INNER BOX SIZE (mm)	CARTON SIZE (mm)	EA PER CARTON	GROSS WEIGHT(Kg)
RS-6/RS-8	-B	400	214*235*56	435*245*186	2,400	16.0

DISCLAIMER NOTICE

Rectron Inc reserves the right to make changes without notice to any product specification herein, to make corrections, modifications, enhancements or other changes. Rectron Inc or anyone on its behalf assumes no responsibility or liability for any errors or inaccuracies. Data sheet specifications and its information contained are intended to provide a product description only. "Typical" parameters which may be included on RECTRON data sheets and/ or specifications can and do vary in different applications and actual performance may vary over time. Rectron Inc does not assume any liability arising out of the application or use of any product or circuit.

Rectron products are not designed, intended or authorized for use in medical, life-saving implant or other applications intended for life-sustaining or other related applications where a failure or malfunction of component or circuitry may directly or indirectly cause injury or threaten a life without expressed written approval of Rectron Inc. Customers using or selling Rectron components for use in such applications do so at their own risk and shall agree to fully indemnify Rectron Inc and its subsidiaries harmless against all claims, damages and expenditures.