

Powerex, Inc., 173 Pavilion Lane, Youngwood, Pennsylvania 15697 (724) 925-7272
www.pwrx.com

Super Fast Recovery Diode Modules 140 Amperes/600 Volts

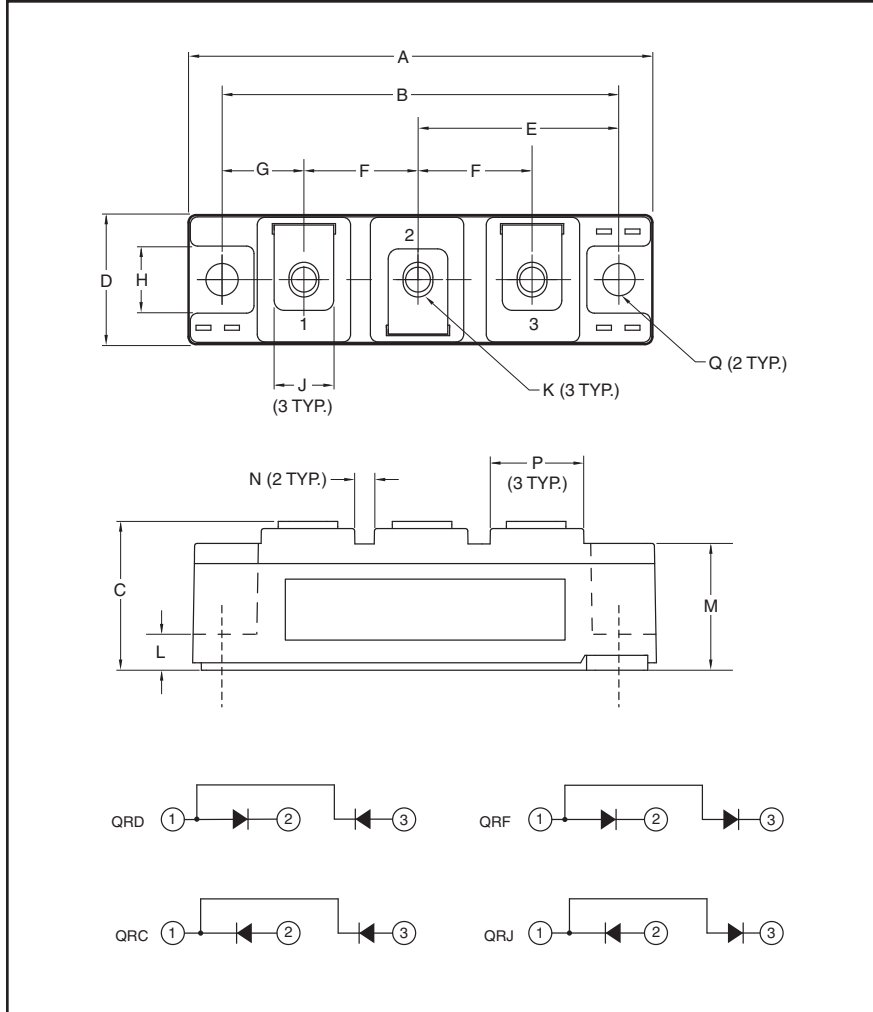

Description:

Powerex Super Fast Recovery Dual Diode Modules are designed for use in applications requiring fast switching. The modules are isolated for easy mounting with other components on common heatsinks.

Features:

- Super Fast Recovery Time
- RoHS Compliant
- Isolated Mounting
- Metal Baseplate
- Low Thermal Impedance
- 2500V Isolating Voltage

Applications:

- Free Wheeling
- Welding and Plasma Cutting Machine

Outline Drawing and Circuit Diagram

| Dimensions | Millimeters |
|------------|-------------|
| A | 93.5 |
| B | 80 |
| C | 30 |
| D | 26 |
| E | 40.5 |
| F | 23 |
| G | 16.5 |
| H | 13 |

| Dimensions | Millimeters |
|------------|-------------|
| J | 12 |
| K | M5 |
| L | 7.5 |
| M | 25.4 |
| N | 4 |
| P | 19 |
| Q | 6.5 Dia. |

QR_0620R30
Super Fast Recovery Dual Diode Modules
 140 Amperes/600 Volts

Absolute Maximum Ratings, $T_j = 25\text{ }^\circ\text{C}$ unless otherwise specified

| Ratings | Symbol | QRD0620R30 QRC0620R30 QRF0620R30 QRJ0620R30 | Units |
|---|-------------|--|------------------------|
| Repetitive Peak Reverse Blocking Voltage | V_{RRM} | 600 | Volts |
| Non-Repetitive Peak Reverse Blocking Voltage | V_{RSM} | $V_{RRM} + 100$ | Volts |
| DC Current, $T_C = 80^\circ\text{C}$ (Resistive load) | $I_{F(DC)}$ | 140 | Amperes |
| Peak Half Cycle Non-repetitive Surge Current ($t = 8.3\text{mS}$, 100% V_{RRM} Reapplied) | I_{FSM} | TBD | Amperes |
| I^2t for Fusing for One Cycle ($t = 8.3\text{mS}$, 100% V_{RRM} Reapplied) | I^2t | TBD | A^2sec |
| Operating Junction Temperature | T_j | -40 to 150 | $^\circ\text{C}$ |
| Storage Temperature | T_{stg} | -40 to 125 | $^\circ\text{C}$ |
| Maximum Mounting Torque, M6 Mounting Screw | — | 26 | in-lb |
| Maximum Mounting Torque, M5 Terminal Screw | — | 17 | in-lb |
| Module Weight (Typical) | — | 150 | Grams |
| V Isolation (60 Hz, Circuit to Base, All Terminals Shorted, $t = 60\text{ sec}$) | V_{RMS} | 2500 | Volts |

Electrical Characteristics, $T_j = 25\text{ }^\circ\text{C}$ unless otherwise specified

| Characteristics | Symbol | Test Conditions | Min. | Typ. | Max. | Units |
|-------------------------|-----------|--|------|------|------|------------------|
| Reverse Leakage Current | I_{RRM} | Rated V_{RRM} | — | — | 1.0 | mA |
| On-State Voltage | V_{FM} | $I_F = 100\text{A}$ | — | 1.6 | 2.3 | Volts |
| | | $I_F = 140\text{A}$ | — | 1.8 | 2.5 | Volts |
| Threshold Voltage | V_{TO} | $T_j = 125^\circ\text{C}$ | — | 1.82 | — | Volts |
| Slope Resistance | r_T | $T_j = 125^\circ\text{C}$ | — | 4.14 | — | $\text{m}\Omega$ |
| Reverse Recovery Time | t_{rr} | $I_f = 100\text{A}$, $di/dt = \text{TBD}$ | — | — | 120 | ns |
| Reverse Recovery Charge | Q_{rr} | $I_f = 100\text{A}$, $di/dt = \text{TBD}$ | — | 4.2 | — | μC |

Thermal and Mechanical Characteristics, $T_j = 25\text{ }^\circ\text{C}$ unless otherwise specified

| Characteristics | Symbol | Test Conditions | Min. | Typ. | Max. | Units |
|---|---------------|-----------------|------|------|-------|--------------------|
| Thermal Resistance, Junction to Case* | $R_{th(j-c)}$ | Per Diode | — | — | 0.205 | $^\circ\text{C/W}$ |
| Contact Thermal Resistance, Case to Sink (Lubricated)* | $R_{th(c-s)}$ | Per Module | — | — | 0.075 | $^\circ\text{C/W}$ |

* T_C , T_f measured point is just under the chip.

QR_0620R30
Super Fast Recovery Dual Diode Modules
 140 Amperes/600 Volts

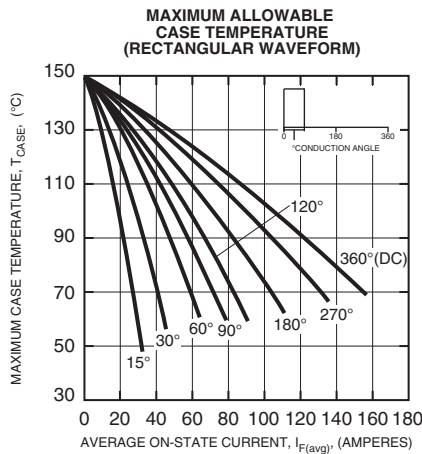
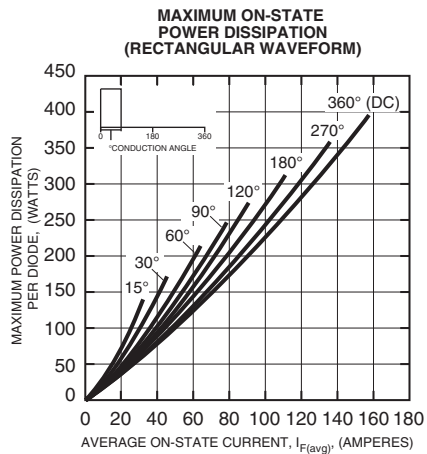
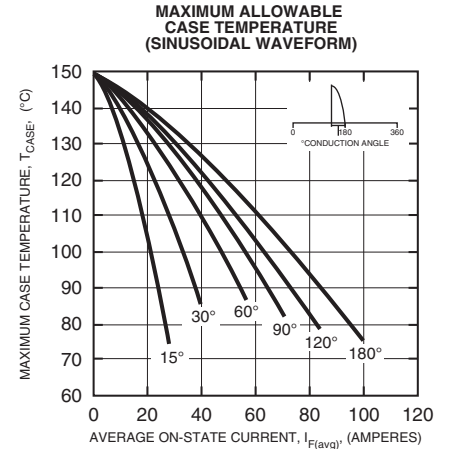
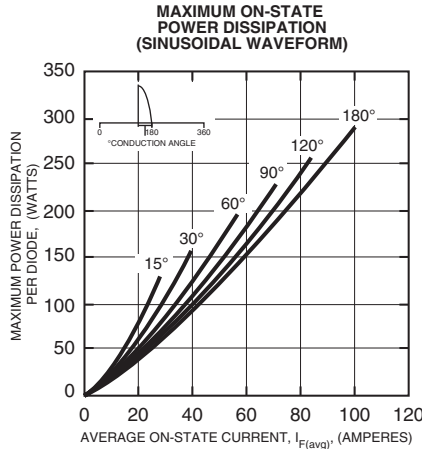
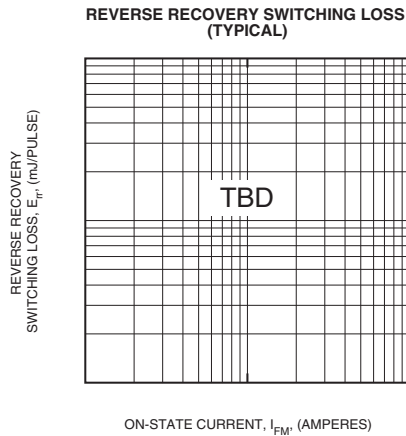
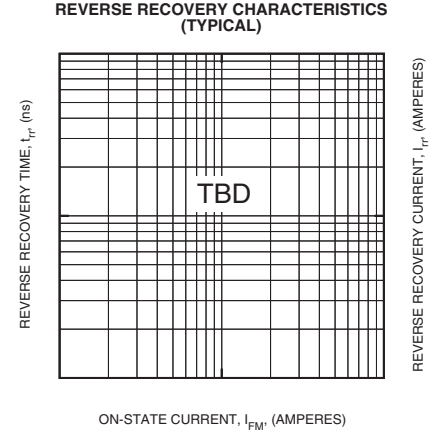
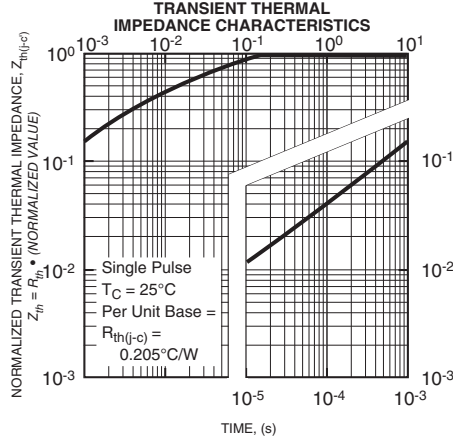
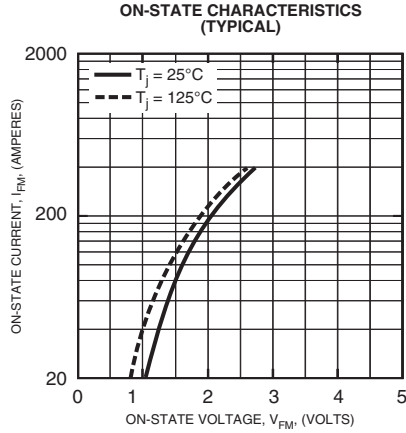

Information presented is based upon manufacturers testing and projected capabilities. This information is subject to change without notice. The manufacturer makes no claim as to the suitability of use, reliability, capability, or future availability of this product.