

LED Drivers for LCD Backlights

White backlight LED Drivers for Small to Medium LCD Panels (Switching Regulator Type)

BD60910GU

No.11040EBT30

●Description

BD60910GU is maximum 8LED(minimum 4LED) serial LED driver with ALC (Auto Luminous Control) function.
Best match for mobile application that needs long battery life.

●Features

- 1) Boost DC/DC for LED back lighting
 - Drives maximum 8 to minimum 4 serial LEDs.
 - Integrated high voltage switching transistor
 - Soft start function.
 - Over voltage protection (Detect voltage is controllable)
 - Over current protection (2nd side)
 - VOUT short to GND protection
 - VOUT open protection.
- 2) Constant current driver for LED back lighting
 - Current step can be set in 7bit(0.2mA 128steps), and 8bit(0.1mA 256steps) in sloping.
 - Rise and fall time of sloping are set independently.
 - Iout max = 25.6mA
 - PWM brightness control by external input.
- 3) Auto Luminous Control (ALC)
 - Periodic ambient detection reduces sensor consumption current.
 - LED brightness can be controlled by 16steps ambient brightness level.
 - LED current for each ambient level is freely customizable.
 - SBIAS for sensor bias is integrated. (3.0V or 2.6V)
 - Photo Diode, Photo Transistor, Photo IC(Linear/ Logarithm) can be connected.
 - Automatic gain control built-in, so BH1600FVC can be connected directly.
- 4) Thermal shutdown (Auto-return type)
- 5) I²C BUS FS mode (max 400kHz) Write/Read
- 6) VCSP85H3(3.00mm x 3.00mm) Small Size CSP package

●Absolute Maximum Ratings (Ta=25 °C)

Parameter	Symbol	Ratings	Unit	Pins
Maximum voltage 1	VMAX1	7	V	except for VLED VOUT, SW
Maximum voltage 2	VMAX2	15	V	VLED
Maximum voltage 3	VMAX3	40	V	VOUT, SW
Power Dissipation	Pd	1250 ^{*1}	mW	
Operating Temperature Range	Topr	-40 ~ +85	°C	
Storage Temperature Range	Tstg	-55 ~ +150	°C	

*1) Power dissipation deleting is 10mW/ °C, when it's used in over 25 °C. It's deleting is on the board that is ROHM's standard.
Dissipation by LSI should not exceed tolerance level of Pd.

●Operating conditions (VBAT≥VIO, Ta=-40~85 °C)

Parameter	Symbol	Ratings	Unit
VBAT input voltage	VBAT	2.7~5.5	V
VIO pin voltage	VIO	1.65~3.3	V

●Electrical Characteristics (Unless otherwise specified, Ta=25°C, VBAT=3.6V, VIO=1.8V)

Parameter	Symbol	Limits			Unit	Condition
		Min.	Typ.	Max.		
【Circuit Current】						
VBAT Circuit current 1	IBAT1	-	0.1	1.0	μA	RESETB=0V, VIO=0V
VBAT Circuit current 2	IBAT2	-	0.5	3.0	μA	RESETB=0V, VIO=1.8V
VBAT Circuit current 3	IBAT3	-	3.5	5.0	mA	LED=ON, ILED=15mA setting Vo=24V
VBAT Circuit current 4	IBAT4	-	0.4	1.0	mA	Only ALC block ON ADCYC=0.52s setting Except sensor current
【LED Driver】						
LED current Step (Setup)	ILEDSTP1	128			Step	
LED current Step (At slope)	ILEDSTP2	256			Step	
LED Maximum current	IMAXWLED	-	25.6	-	mA	
LED current accuracy	IWLED	-7%	15	+7%	mA	ILED=15mA setting
【DC/DC】						
VLED pin feedback voltage	Vfb	-	0.3	-	V	
Over current protection	OCP	-	650	-	mA	
Oscillator frequency	fosc	0.8	1.0	1.2	MHz	
Over Voltage Protection detect voltage	OVP1	30	31	32	V	
	OVP2	-	27	-	V	
	OVP3	-	24	-	V	
	OVP4	-	21	-	V	
	OVP5	-	18	-	V	
Maximum Duty	Mduty	92.5	-	-	%	
VOUT open protection	OVO	-	0.7	1.4	V	

●Electrical Characteristics (Unless otherwise specified, Ta=25°C, VBAT=3.6V, VIO=1.8V)

Parameter	Symbol	Limits			Unit	Condition
		Min.	Typ.	Max.		
【I²C Input (SDA, SCL)】						
LOW level input voltage	VIL	-0.3	-	0.25 × VIO	V	
HIGH level input voltage	VIH	0.75 × VIO	-	VBAT +0.3	V	
Hysteresis of Schmitt trigger input	Vhys	0.05 × VIO	-	-	V	
LOW level output voltage (SDA) at 3mA sink current	VOL	0	-	0.3	V	
Input current each I/O pin	lin	-3	-	3	μA	Input voltage = 0.1×VIO~0.9×VIO
【RESETB】						
LOW level input voltage	VIL	-0.3	-	0.25 × VIO	V	
HIGH level input voltage	VIH	0.75 × VIO	-	VBAT +0.3	V	
Input current each I/O pin	lin	-3	-	3	μA	Input voltage = 0.1×VIO~0.9×VIO

●Electrical Characteristics (Unless otherwise specified, Ta=25°C, VBAT=3.6V, VIO=1.8V)

Parameter	Symbol	Limits			Unit	Condition
		Min.	Typ.	Max.		
【ALC】						
SBIAS Output voltage	VoS	2.850	3.0	3.150	V	Io=200μA <Initial value>
		2.470	2.6	2.730	V	Io=200μA
SBIAS Output current	IoS	-	-	30	mA	Vo=3.0V
SSENS Input range	VISS	0	-	VoS x 255/256	V	
SBIAS Discharge resistor at OFF	ROFFS	-	1.0	1.5	kΩ	
ADC resolution	ADRES	8			bit	
ADC non-linearity error	ADINL	-3	-	+3	LSB	
ADC differential non-linearity error	ADDNL	-1	-	+1	LSB	
SSENS Input impedance	RSENS	1	-	-	MΩ	
【WPWMIN】						
L level input voltage	VILA	-0.3	-	0.3	V	
H level input voltage	VIHA	1.4	-	VBAT +0.3	V	
Input current	IinA	-	3.6	10	μA	Vin=1.8V
PWM input minimum High pulse width	PWpwm	50	-	-	μs	
【GC1, GC2】						
L level output voltage	VOLS	-	-	0.2	V	IOL=1mA
H level output voltage	VOHS	VoS -0.2	-	-	V	IOH=1mA

●Block Diagram / Application Circuit example

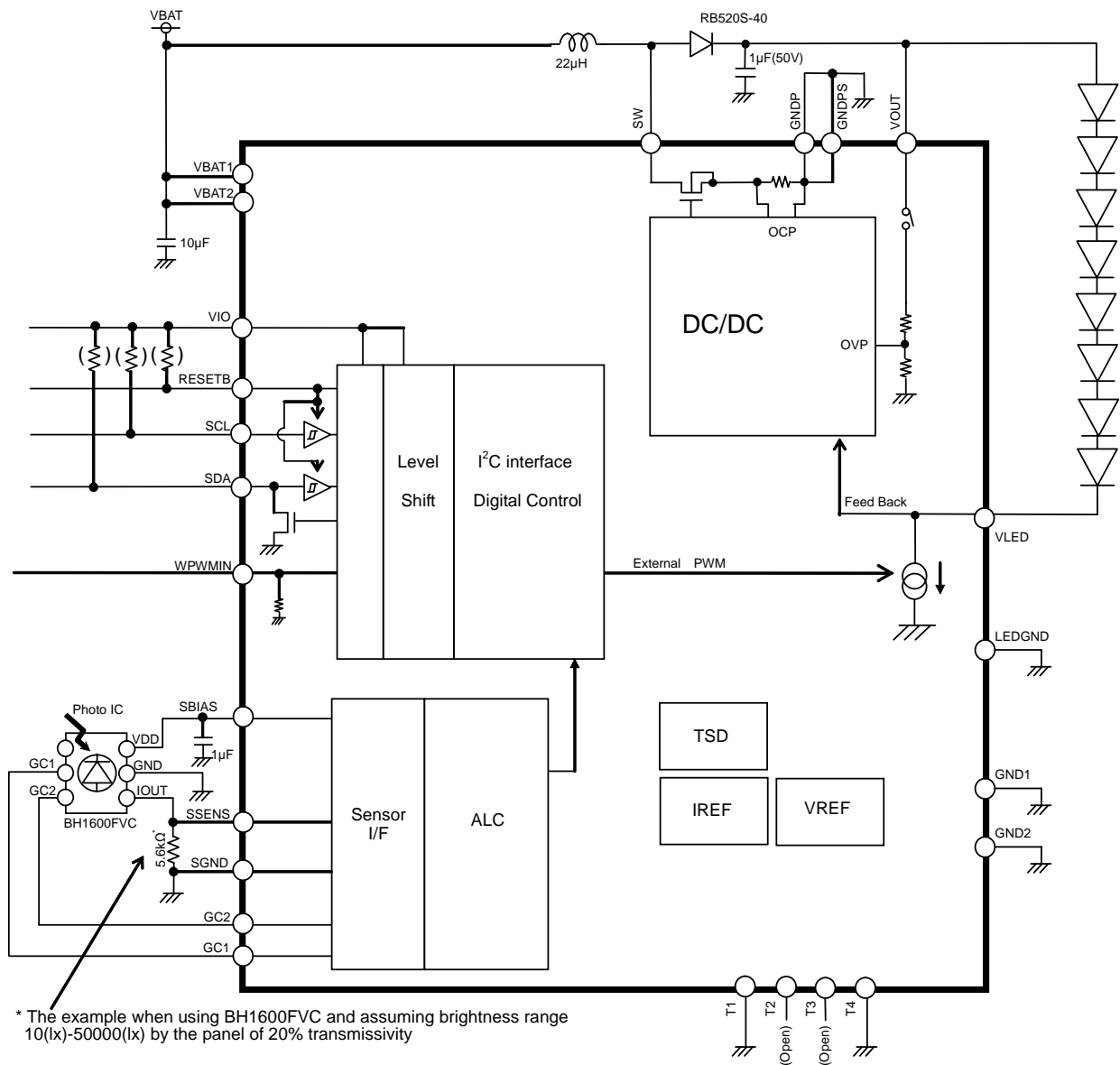

Fig.1 Block Diagram / Application Circuit example

●Pin Arrangement [Bottom View]

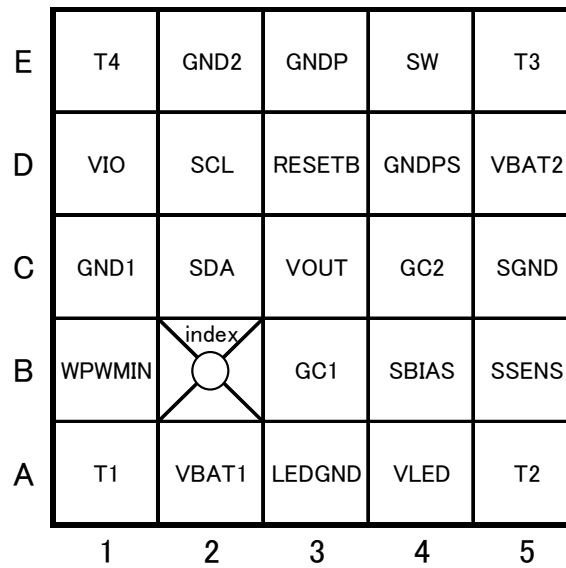
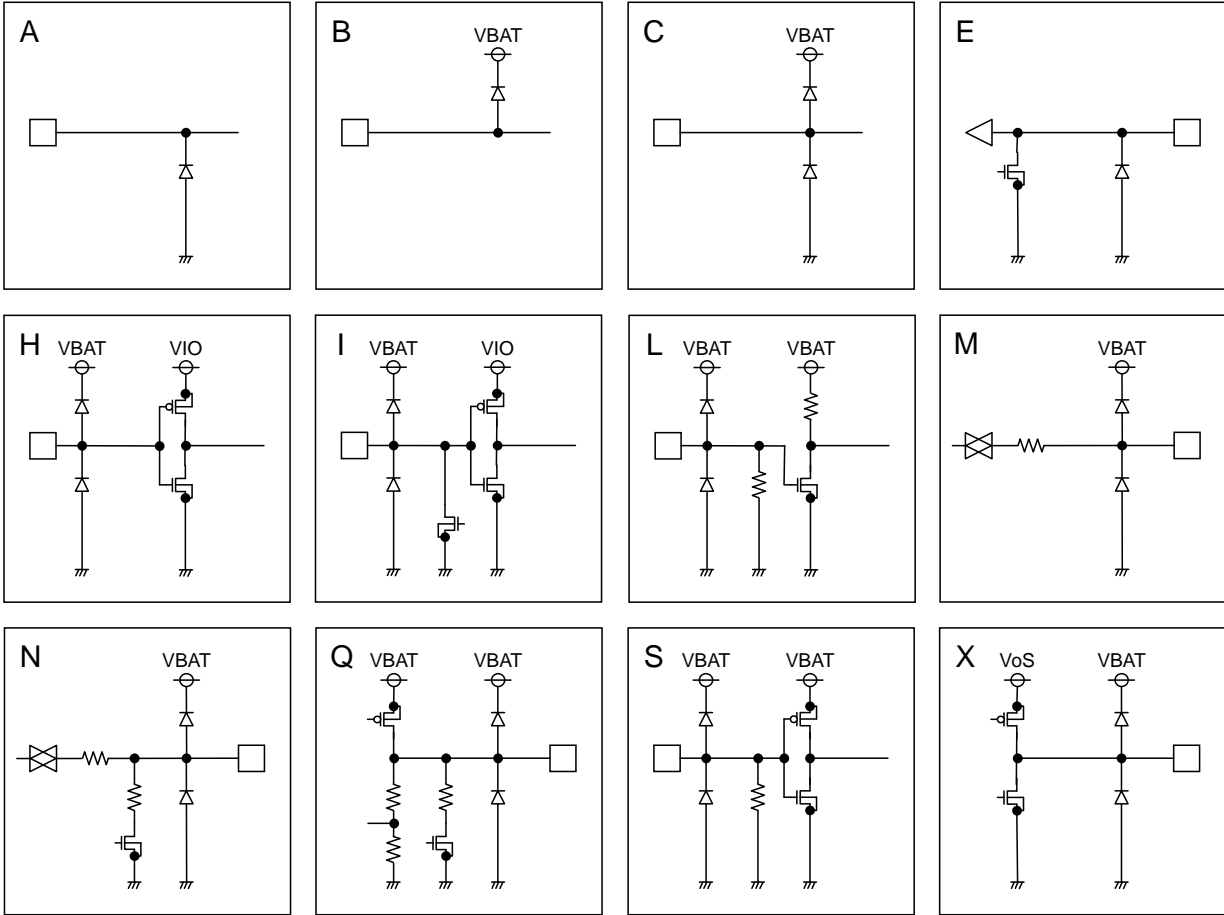

Fig.2 Pin Arrangement

●Pin Functions

No	Ball No.	Pin Name	I/O	ESD Diode		Functions	Equivalent Circuit
				For Power	For Ground		
1	A2	VBAT1	-	-	GND	Power supply	A
2	D5	VBAT2	-	-	GND	Power supply	A
3	D1	VIO	-	VBAT	GND	Power supply for I/O	C
4	C1	GND1	-	VBAT	-	Ground	B
5	E2	GND2	-	VBAT	-	Ground	B
6	A3	LEDGND	-	VBAT	-	Ground	B
7	E3	GNDP	-	VBAT	-	Ground	B
8	D4	GNDPS	-	VBAT	-	Ground	B
9	C5	SGND	-	VBAT	-	Ground	B
10	D3	RESETB	I	VBAT	GND	Reset input (L: reset, H: reset cancel)	H
11	C2	SDA	I/O	VBAT	GND	I ² C data input / output	I
12	D2	SCL	I	VBAT	GND	I ² C clock input	H
13	B1	WPWMIN	I	VBAT	GND	External PWM input	L
14	E4	SW	O	-	GND	DC/DC Switching port	A
15	C3	VOUT	O	-	GND	DC/DC output voltage monitor	A
16	A4	VLED	I	-	GND	LED cathode connection	E
17	B4	SBIAS	O	VBAT	GND	Bias output for the Ambient Light Sensor	Q
18	B5	SSENS	I	VBAT	GND	Ambient Light Sensor input	N
19	B3	GC1	O	VBAT	GND	Ambient Light Sensor gain control output 1	X
20	C4	GC2	O	VBAT	GND	Ambient Light Sensor gain control output 2	X
21	A1	T1	I	VBAT	GND	Test Input Pin (short to Ground)	S
22	A5	T2	O	VBAT	GND	Test Output Pin (Open)	M
23	E5	T3	O	VBAT	GND	Test Output Pin (Open)	N
24	E1	T4	I	VBAT	GND	Test Input Pin (short to Ground)	S

●Equivalent Circuit



● I²C BUS format

The writing/reading operation is based on the I²C slave standard.

- Slave address

A7	A6	A5	A4	A3	A2	A1	R/W
1	1	1	0	1	1	0	1/0

- Bit Transfer

SCL transfers 1-bit data during H. SCL cannot change signal of SDA during H at the time of bit transfer. If SDA changes while SCL is H, START conditions or STOP conditions will occur and it will be interpreted as a control signal.

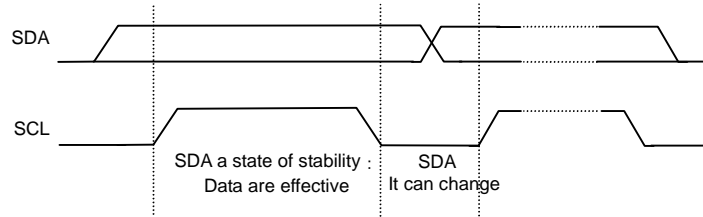

- START and STOP condition

When SDA and SCL are H, data is not transferred on the I²C- bus. This condition indicates, if SDA changes from H to L while SCL has been H, it will become START (S) conditions, and an access start, if SDA changes from L to H while SCL has been H, it will become STOP (P) conditions and an access end.

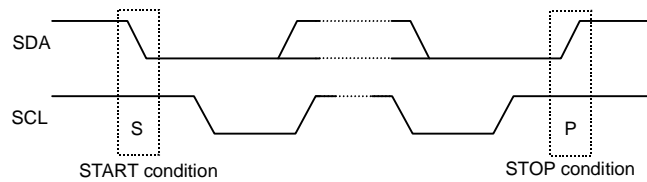

- Acknowledge

It transfers data 8 bits each after the occurrence of START condition. A transmitter opens SDA after transfer 8bits data, and a receiver returns the acknowledge signal by setting SDA to L.

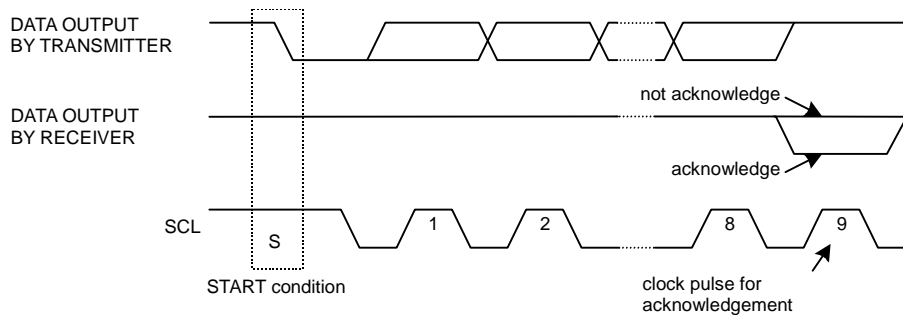

• Writing protocol

A register address is transferred by the next 1 byte that transferred the slave address and the write-in command. The 3rd byte writes data in the internal register written in by the 2nd byte, and after 4th byte or, the increment of register address is carried out automatically. However, when a register address turns into the last address, it is set to 00h by the next transmission. After the transmission end, the increment of the address is carried out.

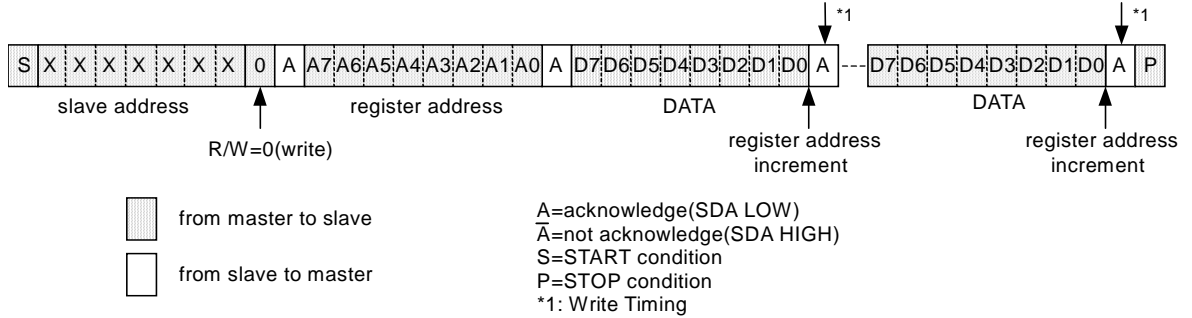

• Reading protocol

It reads from the next byte after writing a slave address and R/W bit. The register to read considers as the following address accessed at the end, and the data of the address that carried out the increment is read after it. If an address turns into the last address, the next byte will read out 00h. After the transmission end, the increment of the address is carried out.

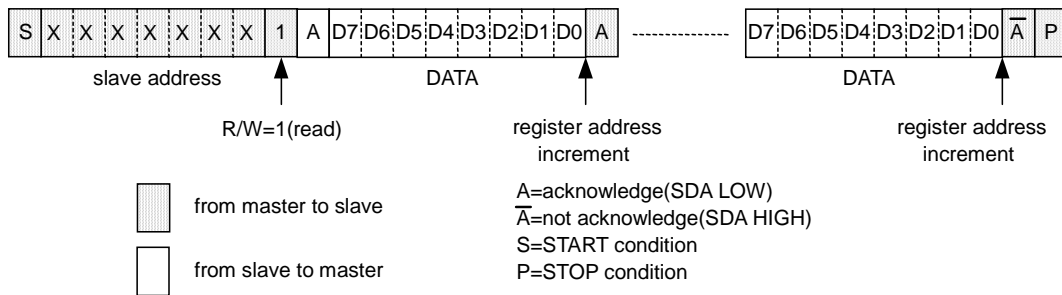

• Multiple reading protocols

After specifying an internal address, it reads by repeated START condition and changing the data transfer direction. The data of the address that carried out the increment is read after it. If an address turns into the last address, the next byte will read out 00h. After the transmission end, the increment of the address is carried out.

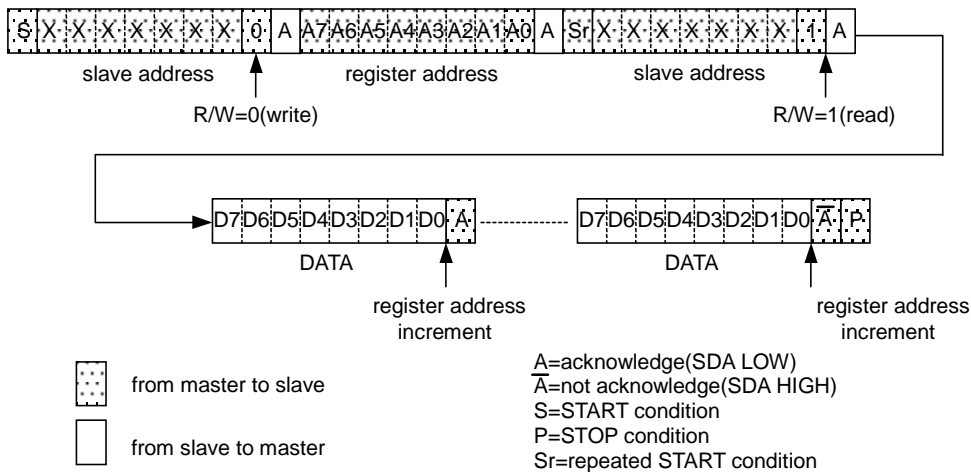

As for reading protocol and multiple reading protocols, please do \bar{A} (not acknowledge) after doing the final reading operation. It stops with read when ending by A(acknowledge), and SDA stops in the state of Low when the reading data of that time is 0. However, this state returns usually when SCL is moved, data is read, and \bar{A} (not acknowledge) is done.

●Timing diagram

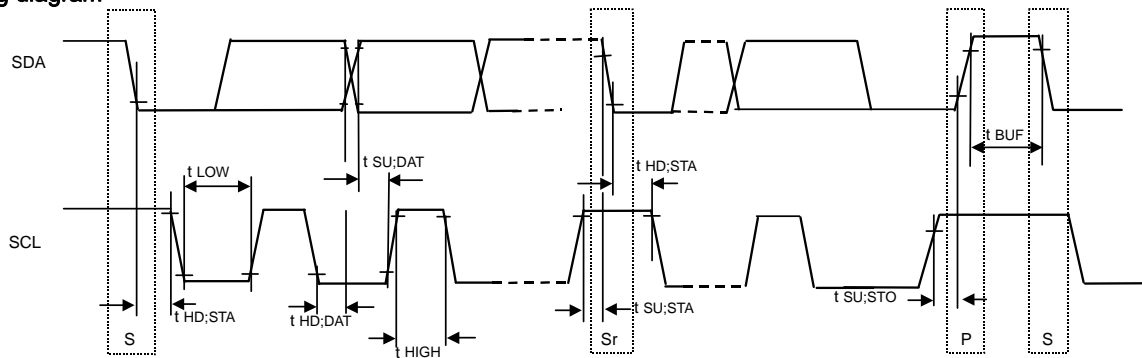
●Electrical Characteristics (Unless otherwise specified, $T_a=25\text{ }^\circ\text{C}$, $V_{BAT}=3.6\text{V}$, $V_{IO}=1.8\text{V}$)

Parameter	Symbol	Standard-mode			Fast-mode			Unit
		Min.	Typ.	Max.	Min.	Typ.	Max.	
[I²C BUS format]								
SCL clock frequency	fSCL	0	-	100	0	-	400	kHz
LOW period of the SCL clock	tLOW	4.7	-	-	1.3	-	-	μs
HIGH period of the SCL clock	tHIGH	4.0	-	-	0.6	-	-	μs
Hold time (repeated) START condition After this period, the first clock is generated	tHD;STA	4.0	-	-	0.6	-	-	μs
Set-up time for a repeated START condition	tSU;STA	4.7	-	-	0.6	-	-	μs
Data hold time	tHD;DAT	0	-	3.45	0	-	0.9	μs
Data set-up time	tSU;DAT	250	-	-	100	-	-	ns
Set-up time for STOP condition	tSU;STO	4.0	-	-	0.6	-	-	μs
Bus free time between a STOP and START condition	tBUF	4.7	-	-	1.3	-	-	μs

● Register List

Input "0" for "-".

Address	W/R	Register data								Function
		D7	D6	D5	D4	D3	D2	D1	D0	
00h	W	-	-	-	-	-	-	-	SFTRST	Software Reset
01h	R/W	-	VOVP(2)	VOVP(1)	VOVP(0)	WPWMEN	ALCEN	LEDMD	LEDEN	LED, ALC, OVP Control
02h	-	-	-	-	-	-	-	-	-	-
03h	R/W	-	ILED(6)	ILED(5)	ILED(4)	ILED(3)	ILED(2)	ILED(1)	ILED(0)	LED Current Setting at non-ALC mode
04h	-	-	-	-	-	-	-	-	-	-
05h	-	-	-	-	-	-	-	-	-	-
06h	-	-	-	-	-	-	-	-	-	-
07h	-	-	-	-	-	-	-	-	-	-
08h	W	THL(3)	THL(2)	THL(1)	THL(0)	TLH(3)	TLH(2)	TLH(1)	TLH(0)	LED Current transition
09h	-	-	-	-	-	-	-	-	-	-
0Ah	-	-	-	-	-	-	-	-	-	-
0Bh	R/W	ADCYC(1)	ADCYC(0)	GAIN(1)	GAIN(0)	STYPE	VSB	MDCIR	SBIASON	ALC mode setting
0Ch	-	-	-	-	-	-	-	-	-	-
0Dh	R	-	-	-	-	AMB(3)	AMB(2)	AMB(1)	AMB(0)	Ambient level output
0Eh	W	-	IU0(6)	IU0(5)	IU0(4)	IU0(3)	IU0(2)	IU0(1)	IU0(0)	LED Current at Ambient level 0h
0Fh	W	-	IU1(6)	IU1(5)	IU1(4)	IU1(3)	IU1(2)	IU1(1)	IU1(0)	LED Current at Ambient level 1h
10h	W	-	IU2(6)	IU2(5)	IU2(4)	IU2(3)	IU2(2)	IU2(1)	IU2(0)	LED Current at Ambient level 2h
11h	W	-	IU3(6)	IU3(5)	IU3(4)	IU3(3)	IU3(2)	IU3(1)	IU3(0)	LED Current at Ambient level 3h
12h	W	-	IU4(6)	IU4(5)	IU4(4)	IU4(3)	IU4(2)	IU4(1)	IU4(0)	LED Current at Ambient level 4h
13h	W	-	IU5(6)	IU5(5)	IU5(4)	IU5(3)	IU5(2)	IU5(1)	IU5(0)	LED Current at Ambient level 5h
14h	W	-	IU6(6)	IU6(5)	IU6(4)	IU6(3)	IU6(2)	IU6(1)	IU6(0)	LED Current at Ambient level 6h
15h	W	-	IU7(6)	IU7(5)	IU7(4)	IU7(3)	IU7(2)	IU7(1)	IU7(0)	LED Current at Ambient level 7h
16h	W	-	IU8(6)	IU8(5)	IU8(4)	IU8(3)	IU8(2)	IU8(1)	IU8(0)	LED Current at Ambient level 8h
17h	W	-	IU9(6)	IU9(5)	IU9(4)	IU9(3)	IU9(2)	IU9(1)	IU9(0)	LED Current at Ambient level 9h
18h	W	-	IUA(6)	IUA(5)	IUA(4)	IUA(3)	IUA(2)	IUA(1)	IUA(0)	LED Current at Ambient level Ah
19h	W	-	IUB(6)	IUB(5)	IUB(4)	IUB(3)	IUB(2)	IUB(1)	IUB(0)	LED Current at Ambient level Bh
1Ah	W	-	IUC(6)	IUC(5)	IUC(4)	IUC(3)	IUC(2)	IUC(1)	IUC(0)	LED Current at Ambient level Ch
1Bh	W	-	IUD(6)	IUD(5)	IUD(4)	IUD(3)	IUD(2)	IUD(1)	IUD(0)	LED Current at Ambient level Dh
1Ch	W	-	IUE(6)	IUE(5)	IUE(4)	IUE(3)	IUE(2)	IUE(1)	IUE(0)	LED Current at Ambient level Eh
1Dh	W	-	IUF(6)	IUF(5)	IUF(4)	IUF(3)	IUF(2)	IUF(1)	IUF(0)	LED Current at Ambient level Fh

Prohibit to accessing the address that isn't mentioned.

The timing indicated by explanation of registers, is a value in case built-in OSC has Typ. frequency.(1MHz)

●Register Map

Address 00h < Software Reset >

Address	R/W	Bit7	Bit6	Bit5	Bit4	Bit3	Bit2	Bit1	Bit0
00h	W	-	-	-	-	-	-	-	SFTRST
Initial Value	00h	-	-	-	-	-	-	-	0

Bit [7:1] : (Not used)

Bit0 : **SFTRST** Software Reset Command
 "0" : Reset cancel
 "1" : Reset (All register initializing)
 Refer to "Explanation 1" for detail.

Address 01h < LED, ALC Control >

Address	R/W	Bit7	Bit6	Bit5	Bit4	Bit3	Bit2	Bit1	Bit0
01h	R/W	-	VOVP(2)	VOVP(1)	VOVP(0)	WPWMEN	ALCEN	LEDMD	LEDEN
Initial Value	00h	-	0	0	0	0	0	0	0

Bit7 : (Not used)

Bit [6:4] : **VOVP(2:0)** Over Voltage Protection detect voltage
 "000" : OVP=31V(typ) 8LED connection
 "001" : OVP=27V(typ) 7LED connection
 "010" : OVP=24V(typ) 6LED connection
 "011" : OVP=21V(typ) 5LED connection
 "100" : OVP=18V(typ) 4LED connection
 "101" : Don't use
 "110" : Don't use
 "111" : Don't use

Refer to "Explanation 4" for detail.

Bit3 : **WPWMEN** External PWM Input "WPWMIN" terminal Enable Control (Valid/Invalid)
 "0" : WPWMIN input invalid
 "1" : WPWMIN input valid
 Refer to "Explanation 5-(10)" for detail.

Bit2 : **ALCEN** ALC Function Control (ON/OFF)
 "0" : ALC function OFF
 "1" : ALC function ON
 Refer to "Explanation 5-(1)" for detail.

Bit1 : **LEDMD** LED Mode Select (ALC mode/Register mode)
 "0" : Register mode
 "1" : ALC mode
 Refer to "Explanation 5-(1)" for detail.

Bit0 : **LEDEN** LED Control (ON/OFF)
 "0" : LED OFF
 "1" : LED ON
 Refer to "Explanation 5-(1)" for detail.

Address 03h < LED Current Setting at Register mode >

Address	R/W	Bit7	Bit6	Bit5	Bit4	Bit3	Bit2	Bit1	Bit0
03h	R/W	-	ILED(6)	ILED(5)	ILED(4)	ILED(3)	ILED(2)	ILED(1)	ILED(0)
Initial Value	00h	-	0	0	0	0	0	0	0

Bit7 : (Not used)

Bit [6:0] : **ILED(6:0)** LED Current Setting at Register mode

"0000000" : 0.2 mA	"1000000" : 13.0 mA
"0000001" : 0.4 mA	"1000001" : 13.2 mA
"0000010" : 0.6 mA	"1000010" : 13.4 mA
"0000011" : 0.8 mA	"1000011" : 13.6 mA
"0000100" : 1.0 mA	"1000100" : 13.8 mA
"0000101" : 1.2 mA	"1000101" : 14.0 mA
"0000110" : 1.4 mA	"1000110" : 14.2 mA
"0000111" : 1.6 mA	"1000111" : 14.4 mA
"0001000" : 1.8 mA	"1001000" : 14.6 mA
"0001001" : 2.0 mA	"1001001" : 14.8 mA
"0001010" : 2.2 mA	"1001010" : 15.0 mA
"0001011" : 2.4 mA	"1001011" : 15.2 mA
"0001100" : 2.6 mA	"1001100" : 15.4 mA
"0001101" : 2.8 mA	"1001101" : 15.6 mA
"0001110" : 3.0 mA	"1001110" : 15.8 mA
"0001111" : 3.2 mA	"1001111" : 16.0 mA
"0010000" : 3.4 mA	"1010000" : 16.2 mA
"0010001" : 3.6 mA	"1010001" : 16.4 mA
"0010010" : 3.8 mA	"1010010" : 16.6 mA
"0010011" : 4.0 mA	"1010011" : 16.8 mA
"0010100" : 4.2 mA	"1010100" : 17.0 mA
"0010101" : 4.4 mA	"1010101" : 17.2 mA
"0010110" : 4.6 mA	"1010110" : 17.4 mA
"0010111" : 4.8 mA	"1010111" : 17.6 mA
"0011000" : 5.0 mA	"1011000" : 17.8 mA
"0011001" : 5.2 mA	"1011001" : 18.0 mA
"0011010" : 5.4 mA	"1011010" : 18.2 mA
"0011011" : 5.6 mA	"1011011" : 18.4 mA
"0011100" : 5.8 mA	"1011100" : 18.6 mA
"0011101" : 6.0 mA	"1011101" : 18.8 mA
"0011110" : 6.2 mA	"1011110" : 19.0 mA
"0011111" : 6.4 mA	"1011111" : 19.2 mA
"0100000" : 6.6 mA	"1100000" : 19.4 mA
"0100001" : 6.8 mA	"1100001" : 19.6 mA
"0100010" : 7.0 mA	"1100010" : 19.8 mA
"0100011" : 7.2 mA	"1100011" : 20.0 mA
"0100100" : 7.4 mA	"1100100" : 20.2 mA
"0100101" : 7.6 mA	"1100101" : 20.4 mA
"0100110" : 7.8 mA	"1100110" : 20.6 mA
"0100111" : 8.0 mA	"1100111" : 20.8 mA
"0101000" : 8.2 mA	"1101000" : 21.0 mA
"0101001" : 8.4 mA	"1101001" : 21.2 mA
"0101010" : 8.6 mA	"1101010" : 21.4 mA
"0101011" : 8.8 mA	"1101011" : 21.6 mA
"0101100" : 9.0 mA	"1101100" : 21.8 mA
"0101101" : 9.2 mA	"1101101" : 22.0 mA
"0101110" : 9.4 mA	"1101110" : 22.2 mA
"0101111" : 9.6 mA	"1101111" : 22.4 mA
"0110000" : 9.8 mA	"1110000" : 22.6 mA
"0110001" : 10.0 mA	"1110001" : 22.8 mA
"0110010" : 10.2 mA	"1110010" : 23.0 mA
"0110011" : 10.4 mA	"1110011" : 23.2 mA
"0110100" : 10.6 mA	"1110100" : 23.4 mA
"0110101" : 10.8 mA	"1110101" : 23.6 mA
"0110110" : 11.0 mA	"1110110" : 23.8 mA
"0110111" : 11.2 mA	"1110111" : 24.0 mA
"0111000" : 11.4 mA	"1111000" : 24.2 mA
"0111001" : 11.6 mA	"1111001" : 24.4 mA
"0111010" : 11.8 mA	"1111010" : 24.6 mA
"0111011" : 12.0 mA	"1111011" : 24.8 mA
"0111100" : 12.2 mA	"1111100" : 25.0 mA
"0111101" : 12.4 mA	"1111101" : 25.2 mA
"0111110" : 12.6 mA	"1111110" : 25.4 mA
"0111111" : 12.8 mA	"1111111" : 25.6 mA

Address 08h < LED Current transition >

Address	R/W	Bit7	Bit6	Bit5	Bit4	Bit3	Bit2	Bit1	Bit0
08h	W	THL(3)	THL(2)	THL(1)	THL(0)	TLH(3)	TLH(2)	TLH(1)	TLH(0)
Initial Value	C7h	1	1	0	0	0	1	1	1

Bit [7:4] : **THL(3:0)** LED current Down transition per 0.2mA step

"0000"	0.256 ms
"0001"	0.512 ms
"0010"	1.024 ms
"0011"	2.048 ms
"0100"	4.096 ms
"0101"	8.192 ms
"0110"	16.38 ms
"0111"	32.77 ms
"1000"	65.54 ms
"1001"	131.1 ms
"1010"	196.6 ms
"1011"	262.1 ms
"1100"	327.7 ms (Initial value)
"1101"	393.2 ms
"1110"	458.8 ms
"1111"	524.3 ms

Refer to "Explanation 5-(8)" for detail.

Bit [3:0] : **TLH(3:0)** LED current Up transition per 0.2mA step

"0000"	0.256 ms
"0001"	0.512 ms
"0010"	1.024 ms
"0011"	2.048 ms
"0100"	4.096 ms
"0101"	8.192 ms
"0110"	16.38 ms
"0111"	32.77 ms (Initial value)
"1000"	65.54 ms
"1001"	131.1 ms
"1010"	196.6 ms
"1011"	262.1 ms
"1100"	327.7 ms
"1101"	393.2 ms
"1110"	458.8 ms
"1111"	524.3 ms

Refer to "Explanation 5-(8)" for detail.

Address 0Bh < ALC mode setting >

Address	R/W	Bit7	Bit6	Bit5	Bit4	Bit3	Bit2	Bit1	Bit0
0Bh	R/W	ADCYC(1)	ADCYC(0)	GAIN(1)	GAIN(0)	STYPE	VSB	MDCIR	SBIASON
Initial Value	81h	1	0	0	0	0	0	0	1

Bit [7:6] : **ADCYC(1:0)** ADC Measurement Cycle

- "00" : 0.52 s
- "01" : 1.05 s
- "10" : 1.57 s (Initial value)
- "11" : 2.10 s

Refer to "Explanation 5-(4)" for detail.

Bit [5:4] : **GAIN(1:0)** Sensor Gain Switching Function Control

- "00" : Auto Change (Initial value)
- "01" : Manual High
- "10" : Manual Low
- "11" : Fixed

Refer to "Explanation 5-(3),5-(6)" for detail.

Bit3 : **STYPE** Ambient Light Sensor Type Select (Linear/Logarithm)

- "0" : For Linear Sensor (Initial value)
- "1" : For Log Sensor

Refer to "Explanation 5-(6)" for detail.

Bit2 : **VSB** SBIAS Output Voltage Control

- "0" : SBIAS output voltage 3.0V (Initial value)
- "1" : SBIAS output voltage 2.6V

Refer to "Explanation 5-(2)" for detail.

Bit1 : **MDCIR** LED Current Reset Select by Mode Change

- "0" : LED current non-reset at mode change (Initial value)
- "1" : LED current reset at mode change

Refer to "Explanation 5-(9)" for detail.

Bit0 : **SBIASON** SBIAS Control (ON/OFF)

- "0" : Measurement cycle synchronous
- "1" : Usually ON (at ALCEN=1) (Initial value)

Refer to "Explanation 5-(4)" for detail.

Address 0Dh < Ambient level (Read Only) >

Address	R/W	Bit7	Bit6	Bit5	Bit4	Bit3	Bit2	Bit1	Bit0
0Dh	R	-	-	-	-	AMB(3)	AMB(2)	AMB(1)	AMB(0)
Initial Value	-	-	-	-	-	-	-	-	-

Bit [7:4] : (Not used)

Bit [3:0] : **AMB(3:0)** Ambient Level

"0000" : 0h
 "0001" : 1h
 "0010" : 2h
 "0011" : 3h
 "0100" : 4h
 "0101" : 5h
 "0110" : 6h
 "0111" : 7h
 "1000" : 8h
 "1001" : 9h
 "1010" : Ah
 "1011" : Bh
 "1100" : Ch
 "1101" : Dh
 "1110" : Eh
 "1111" : Fh

The data can be read through I²C.
Refer to "Explanation 5-(6)" for detail.

Address 0Eh~1Dh < LED Current at Ambient level 0h~Fh >

Address	R/W	Bit7	Bit6	Bit5	Bit4	Bit3	Bit2	Bit1	Bit0
0Eh~1Dh	W	-	IU*(6)	IU*(5)	IU*(4)	IU*(3)	IU*(2)	IU*(1)	IU*(0)
Initial Value	-	Refer to "Explanation 5-(7)" for initial table							

"*" means 0~F.

Bit7 : (Not used)

Bit [6:0] : IU*(6:0) LED Current at Ambient Level for 0h~Fh

"0000000" : 0.2 mA	"1000000" : 13.0 mA
"0000001" : 0.4 mA	"1000001" : 13.2 mA
"0000010" : 0.6 mA	"1000010" : 13.4 mA
"0000011" : 0.8 mA	"1000011" : 13.6 mA
"0000100" : 1.0 mA	"1000100" : 13.8 mA
"0000101" : 1.2 mA	"1000101" : 14.0 mA
"0000110" : 1.4 mA	"1000110" : 14.2 mA
"0000111" : 1.6 mA	"1000111" : 14.4 mA
"0001000" : 1.8 mA	"1001000" : 14.6 mA
"0001001" : 2.0 mA	"1001001" : 14.8 mA
"0001010" : 2.2 mA	"1001010" : 15.0 mA
"0001011" : 2.4 mA	"1001011" : 15.2 mA
"0001100" : 2.6 mA	"1001100" : 15.4 mA
"0001101" : 2.8 mA	"1001101" : 15.6 mA
"0001110" : 3.0 mA	"1001110" : 15.8 mA
"0001111" : 3.2 mA	"1001111" : 16.0 mA
"0010000" : 3.4 mA	"1010000" : 16.2 mA
"0010001" : 3.6 mA	"1010001" : 16.4 mA
"0010010" : 3.8 mA	"1010010" : 16.6 mA
"0010011" : 4.0 mA	"1010011" : 16.8 mA
"0010100" : 4.2 mA	"1010100" : 17.0 mA
"0010101" : 4.4 mA	"1010101" : 17.2 mA
"0010110" : 4.6 mA	"1010110" : 17.4 mA
"0010111" : 4.8 mA	"1010111" : 17.6 mA
"0011000" : 5.0 mA	"1011000" : 17.8 mA
"0011001" : 5.2 mA	"1011001" : 18.0 mA
"0011010" : 5.4 mA	"1011010" : 18.2 mA
"0011011" : 5.6 mA	"1011011" : 18.4 mA
"0011100" : 5.8 mA	"1011100" : 18.6 mA
"0011101" : 6.0 mA	"1011101" : 18.8 mA
"0011110" : 6.2 mA	"1011110" : 19.0 mA
"0011111" : 6.4 mA	"1011111" : 19.2 mA
"0100000" : 6.6 mA	"1100000" : 19.4 mA
"0100001" : 6.8 mA	"1100001" : 19.6 mA
"0100010" : 7.0 mA	"1100010" : 19.8 mA
"0100011" : 7.2 mA	"1100011" : 20.0 mA
"0100100" : 7.4 mA	"1100100" : 20.2 mA
"0100101" : 7.6 mA	"1100101" : 20.4 mA
"0100110" : 7.8 mA	"1100110" : 20.6 mA
"0100111" : 8.0 mA	"1100111" : 20.8 mA
"0101000" : 8.2 mA	"1101000" : 21.0 mA
"0101001" : 8.4 mA	"1101001" : 21.2 mA
"0101010" : 8.6 mA	"1101010" : 21.4 mA
"0101011" : 8.8 mA	"1101011" : 21.6 mA
"0101100" : 9.0 mA	"1101100" : 21.8 mA
"0101101" : 9.2 mA	"1101101" : 22.0 mA
"0101110" : 9.4 mA	"1101110" : 22.2 mA
"0101111" : 9.6 mA	"1101111" : 22.4 mA
"0110000" : 9.8 mA	"1110000" : 22.6 mA
"0110001" : 10.0 mA	"1110001" : 22.8 mA
"0110010" : 10.2 mA	"1110010" : 23.0 mA
"0110011" : 10.4 mA	"1110011" : 23.2 mA
"0110100" : 10.6 mA	"1110100" : 23.4 mA
"0110101" : 10.8 mA	"1110101" : 23.6 mA
"0110110" : 11.0 mA	"1110110" : 23.8 mA
"0110111" : 11.2 mA	"1110111" : 24.0 mA
"0111000" : 11.4 mA	"1111000" : 24.2 mA
"0111001" : 11.6 mA	"1111001" : 24.4 mA
"0111010" : 11.8 mA	"1111010" : 24.6 mA
"0111011" : 12.0 mA	"1111011" : 24.8 mA
"0111100" : 12.2 mA	"1111100" : 25.0 mA
"0111101" : 12.4 mA	"1111101" : 25.2 mA
"0111110" : 12.6 mA	"1111110" : 25.4 mA
"0111111" : 12.8 mA	"1111111" : 25.6 mA

●Contents of “Explanation for operate”

1. Reset
 - (1) Software reset
 - (2) Hardware reset
 - (3) Reset sequence
2. Thermal shutdown
3. DC/DC for LED Driver
4. Protection function
 - (1) Over voltage protection
 - (2) Over current protection
 - (3) VOUT short to GND protection
 - (4) VOUT open protection
5. ALC (Auto Luminous Control) and LED Driver
 - (1) ALC ON/OFF
 - (2) I/V conversion
 - (3) Sensor Gain control
 - (4) A/D conversion
 - (5) Average filter
 - (6) Ambient level detection
 - (7) LED current assignment
 - (8) Slope process
 - (9) LED current reset at mode change
 - (10) Current adjustment (External PWM)
6. I/O
7. The unused terminal

●Explanation for operate

1. Reset

There are two kinds of reset, software reset and hardware reset.

(1) Software reset

- All the registers are initialized more than making a register (SFTRST) setup "1".
- The register of software resetting is an automatic return (Auto Return 0).

(2) Hardware reset

- RESETB pin "H" → "L" to shift hardware reset.
- Under hardware reset, all registers and output pins are initialized, and I²C access are stopped.
- RESETB pin "L" → "H" to release from hardware reset
- RESETB pin has delay circuit. It doesn't recognize as hardware reset in "L" period under 5μs.

(3) Reset Sequence

- When hardware reset was done during software reset, software reset is canceled when hardware reset is canceled. (Because the initial value of software reset is "0")

2. Thermal shutdown

Thermal shutdown function is effective in the following blocks.

DC/DC
LED Driver

A thermal shutdown function works in about 190°C.

Detection temperature has a hysteresis, and detection release temperature is about 170°C.
(Design reference value)

3. DC/DC for LED driver

DC/DC block is designed for the power supply for LED driver.

Start

DC/DC circuit operates when LEDEN turns ON.

Soft start

Soft start function built-in to prevent rush current at start of the DC/DC.

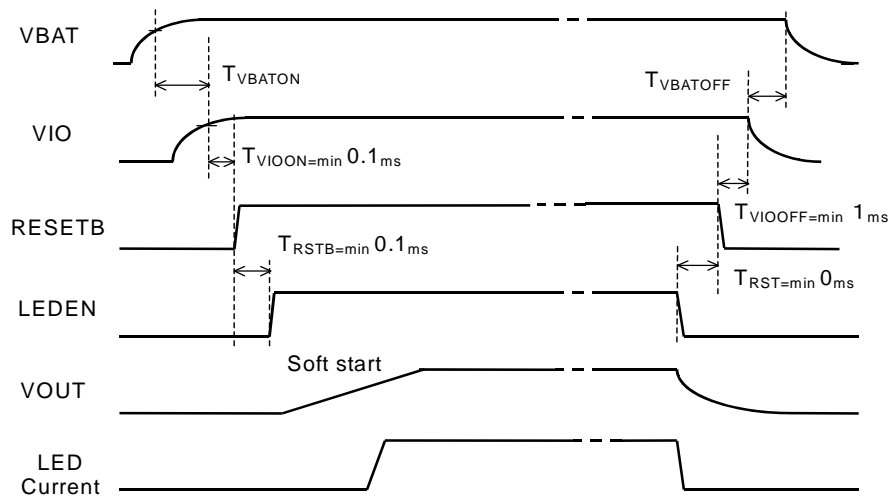

4. Protection function

(1) Over voltage protection

Over Voltage Protection prevents the over-voltage of the VOUT terminal. If the VOUT voltage is over detect voltage, it stopping DC/DC switching. After stopping the switching, if VOUT is drop under un-detect voltage, the switching is re-start.

The OVP voltage can be changed by the register.

It is possible that an OVP voltage is set up suitably in accordance with the Vf and the number of LED that you use. Set it up toward an approximate goal of the following formula.

$$\text{OVP voltage} \geq (\text{LED number}) \times (\text{LED Vf max}) + 1 \text{ [V]}$$

(2) Over current protection

Switching Overcurrent detection is done by the resistance arranged under the switching Tr. If it detect over current level, it is stopping DC/DC switching. Switching begins again when a state of over-current is canceled.

(3) VOUT short to GND protection

The detection of a state of ground short of the VOUT terminal.

DC/DC switching does stop at the time of the detection. Switching begins again when a state of detection is canceled.

(4) VOUT open protection

The detection of a state of Open of the VOUT terminal.

DC/DC switching does stop at the time of the detection. Switching begins again when a state of detection is canceled.

5. The explanation of ALC (Auto Luminous Control)

LCD backlight current adjustment is possible in the basis of ambient brightness by external sensor.

- Extensive selection of the ambient light sensors (Photo Diode, Photo Transistor, Photo IC(linear)) is possible by built-in adjustment feature of Sensor bias, ADC with average filter and logarithm conversion.
- Ambient brightness is changed into ambient level by digital data processing, and it can be read through I²C I/F.
- Register setting can customize a conversion to LED current. (Initial value is pre-set.)
- Natural dimming of LED driver is possible with the adjustment of the current transition speed.

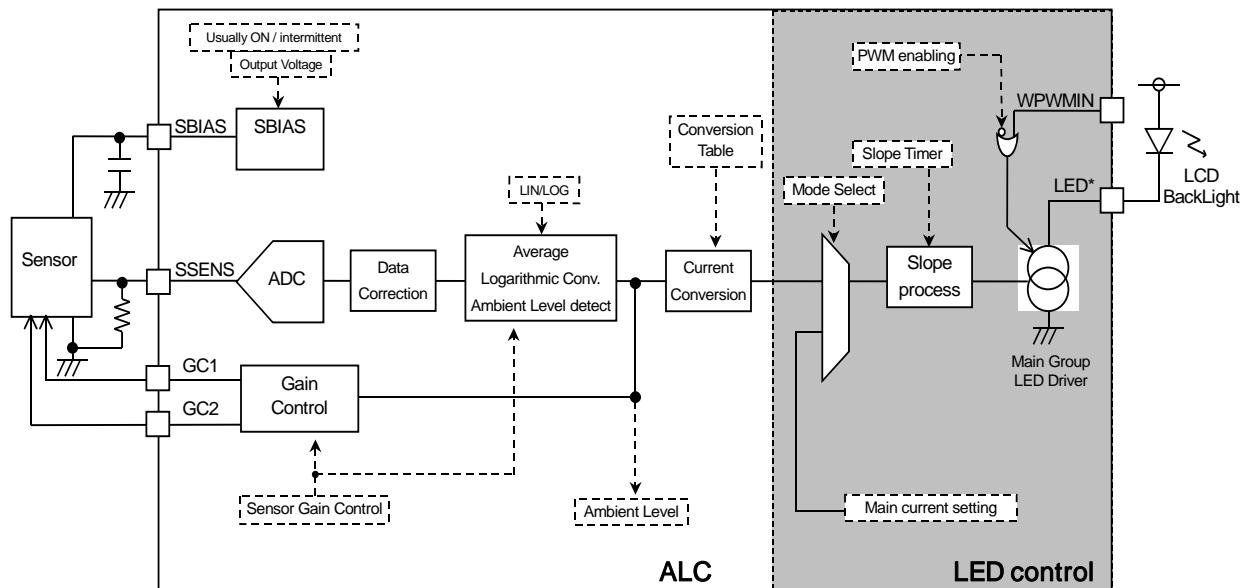

* Wave form in this explanation just shows operation image, not shows absolute value precisely.

(1) Auto Luminous Control ON/OFF

- ALC block can be independent setting ON/OFF.
- It can use only to measure the Ambient level.
Register : ALCEN
Register : LEDEN
Register : LEDMD
- Refer to under about the associate ALC mode and LED current.

ALCEN	LEDEN	LEDMD	ALC	LED control	Mode	LED current
0	0	*	OFF (AMB(3:0)=0h)	OFF	OFF	OFF
0	1	0		ON	Resister mode	ILED(6:0)
0	1	1		ON		IU0(6:0) (*1)
1	0	*	ON	OFF	ALC mode	OFF
1	1	0		ON		ILED(6:0)
1	1	1		ON		ALC mode (*2)

(*1) LED current is selected IU0(6:0), because of ALC is OFF, AMB(3:0)=0h.

(*2) LED current is selected IU0(6:0)~IUF(6:0) corresponding to each ambient level.

(2) I/V conversion

- The bias voltage and external resistance for the I-V conversion (R_s) are adjusted with adaptation of sensor characteristic
- The bias voltage is selectable by register setup.

Register : VSB

“0” : SBIAS output voltage 3.0V

“1” : SBIAS output voltage 2.6V

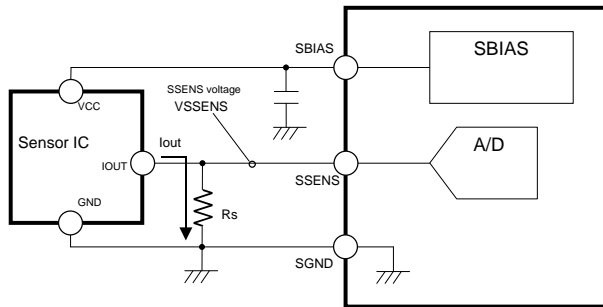

R_s : Sense resistance (A sensor output current is changed into the voltage value.)
 SBIAS : Bias power supply terminal for the sensor (3.0V / 2.6V by register setting)
 SSENS : Sense voltage input terminal

$$\text{SSENS Voltage} = I_{out} \times R_s$$

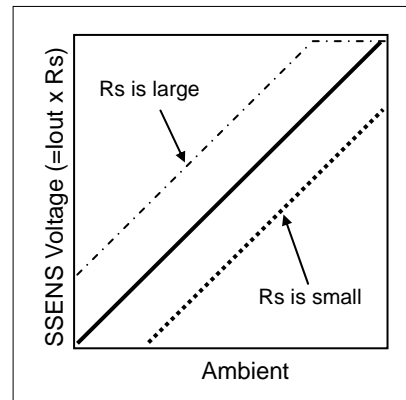
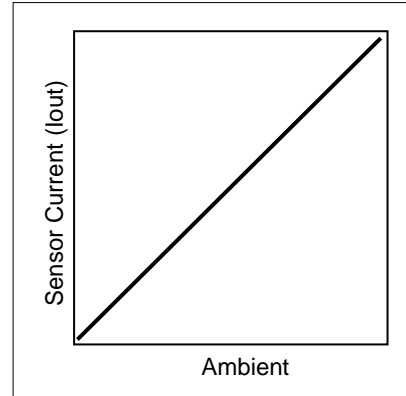

(3) Sensor Gain control

- Sensor gain switching function is built in to extend the dynamic range.
- It is controlled by register setup.
- When automatic gain control is off, the gain status can be set up in the manual.
Register : GAIN(1:0)
- GC1 and GC2 are outputted corresponding to each gain status.

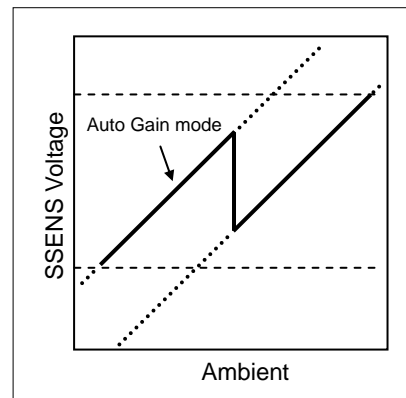
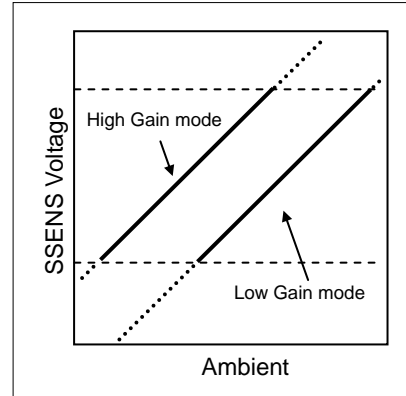

	Example 1 (Use BH1600FVC)				Example 2				Example 3	
Application example										
					Resistor values are relative					
Operating mode	Auto	Manual		Auto	Manual		Fixed			
		High	Low		High	Low				
GAIN(1:0) setting	00	01	10	00	01	10	11			
Gain status	High Low	High	Low	High Low	High	Low	-			
GC1 output		L		L		L		L		
GC2 output	L		L		L		L		L	

: This means that it becomes High with A/D measurement cycle synchronously.

(*1) : Set up the relative ratio of the resistance in the difference in the brightness change of the High Gain mode and the Low Gain mode carefully.

(4) A/D conversion

- The detection of ambient data is done periodically for the low power.
- SBIAS and ADC are turned off except for the ambient measurement.
- The sensor current may be shut in this function, it can possible to decrease the current consumption.
- SBIAS pin and SSENS pin are pull-down in internal when there are OFF.
- SBIAS circuit has the two modes. (Usually ON mode or intermittent mode)

Register : ADCYC(1:0)

Register : SBIASON

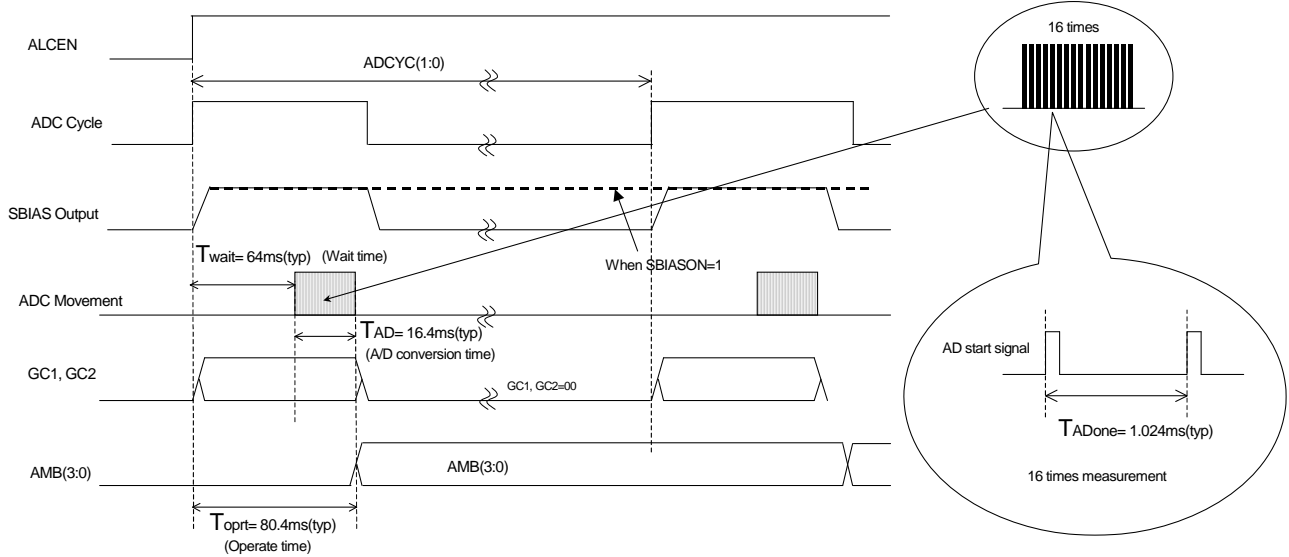

(5) Average filter

- Average filter is built in to rid noise or flicker.
- 16 times averaging.

(6) Ambient level detection

- Averaged A/D value is converted to Ambient level corresponding to Gain control and sensor type.
- Ambient level is judged to rank of 16 steps by ambient data.
- The type of ambient light sensor can be chosen by register.
(Linear type sensor / Logarithm type sensor)

Register : STYPE

“0” : For Linear sensor

“1” : For Log sensor

- Ambient level is output through I²C.

Register : AMB(3:0)

STYPE	0					1	
GAIN(1:0)	00		10	01	11	XX	
Gain Status	Auto Low	Auto High	Manual Low	Manual High	Fixed	Fixed	
Ambient level	SSENS voltage						
0h	This area is not assigned.	VoS × 0 / 256	This area is not assigned.	VoS × 0 / 256	VoS × 0 / 256	VoS × 0 / 256 VoS × 17 / 256	
1h		VoS × 1 / 256		VoS × 1 / 256	VoS × 1 / 256	VoS × 18 / 256 VoS × 26 / 256	
2h		VoS × 2 / 256		VoS × 2 / 256	VoS × 2 / 256	VoS × 27 / 256 VoS × 36 / 256	
3h		VoS × 3 / 256 VoS × 4 / 256		VoS × 3 / 256 VoS × 4 / 256	VoS × 3 / 256 VoS × 4 / 256	VoS × 3 / 256 VoS × 4 / 256	VoS × 37 / 256 VoS × 47 / 256
4h		VoS × 5 / 256 VoS × 7 / 256		VoS × 5 / 256 VoS × 7 / 256	VoS × 5 / 256 VoS × 7 / 256	VoS × 5 / 256 VoS × 6 / 256	VoS × 48 / 256 VoS × 59 / 256
5h	VoS × 0 / 256	VoS × 8 / 256 VoS × 12 / 256	VoS × 0 / 256	VoS × 8 / 256 VoS × 12 / 256	VoS × 7 / 256 VoS × 9 / 256	VoS × 60 / 256 VoS × 71 / 256	
6h	VoS × 1 / 256	VoS × 13 / 256 VoS × 21 / 256	VoS × 1 / 256	VoS × 13 / 256 VoS × 21 / 256	VoS × 10 / 256 VoS × 13 / 256	VoS × 72 / 256 VoS × 83 / 256	
7h	VoS × 2 / 256 VoS × 3 / 256	VoS × 22 / 256 VoS × 37 / 256	VoS × 2 / 256 VoS × 3 / 256	VoS × 22 / 256 VoS × 37 / 256	VoS × 14 / 256 VoS × 19 / 256	VoS × 84 / 256 VoS × 95 / 256	
8h	VoS × 4 / 256 VoS × 6 / 256	VoS × 38 / 256 VoS × 65 / 256	VoS × 4 / 256 VoS × 6 / 256	VoS × 38 / 256 VoS × 65 / 256	VoS × 20 / 256 VoS × 27 / 256	VoS × 96 / 256 VoS × 107 / 256	
9h	VoS × 7 / 256 VoS × 11 / 256	VoS × 66 / 256 VoS × 113 / 256	VoS × 7 / 256 VoS × 11 / 256	VoS × 66 / 256 VoS × 113 / 256	VoS × 28 / 256 VoS × 38 / 256	VoS × 108 / 256 VoS × 119 / 256	
Ah	VoS × 12 / 256 VoS × 20 / 256	VoS × 114 / 256 VoS × 199 / 256	VoS × 12 / 256 VoS × 20 / 256	VoS × 114 / 256 VoS × 199 / 256	VoS × 39 / 256 VoS × 53 / 256	VoS × 120 / 256 VoS × 131 / 256	
Bh	VoS × 21 / 256 VoS × 36 / 256	VoS × 200 / 256 VoS × 255 / 256	VoS × 21 / 256 VoS × 36 / 256	VoS × 200 / 256 VoS × 255 / 256	VoS × 54 / 256 VoS × 74 / 256	VoS × 132 / 256 VoS × 143 / 256	
Ch	VoS × 37 / 256 VoS × 64 / 256	This area is not assigned.	VoS × 37 / 256 VoS × 64 / 256	This area is not assigned.	VoS × 75 / 256 VoS × 104 / 256	VoS × 144 / 256 VoS × 155 / 256	
Dh	VoS × 65 / 256 VoS × 114 / 256		VoS × 65 / 256 VoS × 114 / 256		VoS × 65 / 256 VoS × 114 / 256	VoS × 105 / 256 VoS × 144 / 256	VoS × 156 / 256 VoS × 168 / 256
Eh	VoS × 115 / 256 VoS × 199 / 256		VoS × 115 / 256 VoS × 199 / 256		VoS × 115 / 256 VoS × 199 / 256	VoS × 145 / 256 VoS × 199 / 256	VoS × 169 / 256 VoS × 181 / 256
Fh	VoS × 200 / 256 VoS × 255 / 256		VoS × 200 / 256 VoS × 255 / 256		VoS × 200 / 256 VoS × 255 / 256	VoS × 200 / 256 VoS × 255 / 256	VoS × 182 / 256 VoS × 255 / 256

- In the Auto Gain control mode, sensor gain changes in gray-colored ambient level.

(7) LED current assignment

- LED current can be assigned as each of 16 steps of the ambient level.
- Register setting can customize a conversion to LED current. (Initial value is pre-set.)

Register : IU*(6:0)

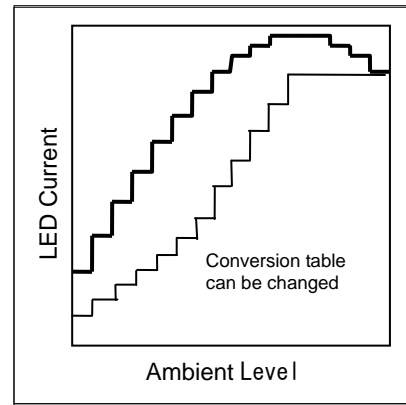

Conversion Table (initial value)

Ambient Level	Setting data	Current value	Ambient Level	Setting data	Current value
0h	11h	3.6mA	8h	48h	14.6mA
1h	13h	4.0mA	9h	56h	17.4mA
2h	15h	4.4mA	Ah	5Fh	19.2mA
3h	18h	5.0mA	Bh	63h	20.0mA
4h	1Eh	6.2mA	Ch	63h	20.0mA
5h	25h	7.6mA	Dh	63h	20.0mA
6h	2Fh	9.6mA	Eh	63h	20.0mA
7h	3Bh	12.0mA	Fh	63h	20.0mA

(8) Slope process

- Slope process is given to LED current to dim naturally.
- LED current changes in the 256Step gradation in sloping.
- Up(dark→bright),Down(bright→dark) LED current transition speed are set individually.

Register : THL(3:0)

Register : TLH(3:0)

- LED current changes as follows at the time as the slope.

TLH (THL) is setup of time of the current step 2/256.

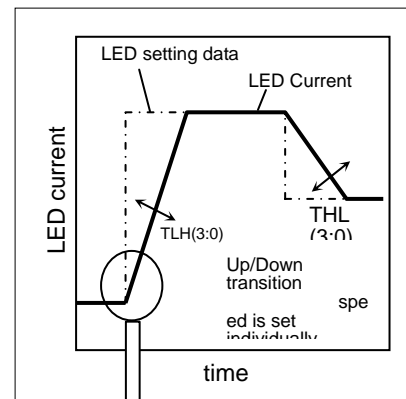
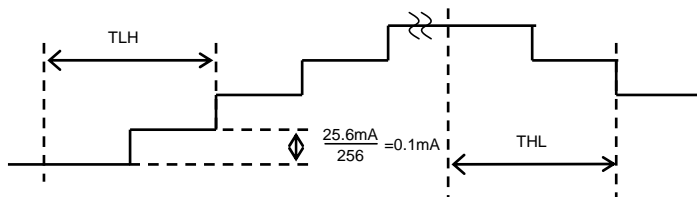

Zoom

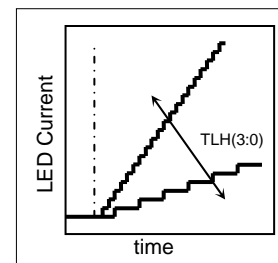

(9) LED current reset when mode change

- Selectable the way to sloping at mode change.

(ALC ↔ Resister)

Register : MDCIR

“0” : LED current non-reset at mode change

“1” : LED current reset at mode change

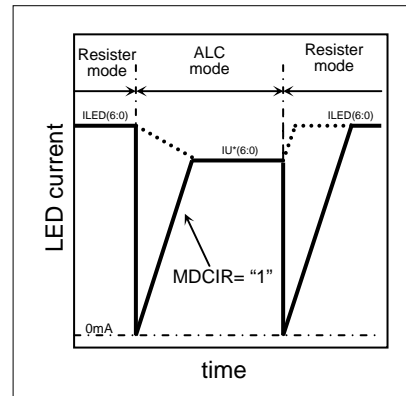
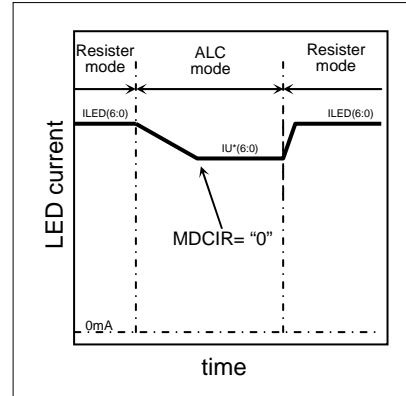

(10) Current adjustment (External PWM)

- PWM drive by the external terminal (WPWMIN) is possible with permission by the register setting.

Register : WPWMEN

- It is suitable for the intensity correction by external control, because PWM based on LED current of register setup or ALC control.

WPWMEN	WPWMIN (External input)	LED current	
0	L	ON	PWM input invalid
0	H	ON	
1	L	Forced OFF	PWM input valid
1	H	ON	

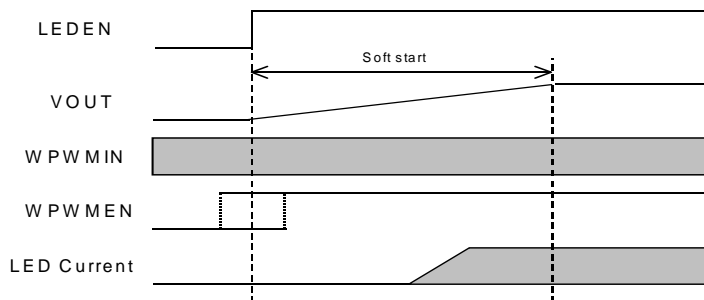

WPWMIN input before LEDEN=1 is enable.
 Setting PWMEN=1 before LEDEN=1 is enable.
 PWM control is effective at the LED current rises up.

PWM “H” pulse width must be more than 50 μs.

6. The explanation of I/O

When the RESETB pin "L", the input buffers (SDA and SCL) are disabling for the low consumption power.

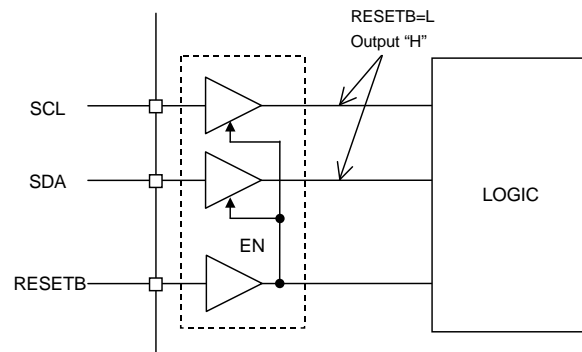

7. The unused terminal

Set up of the unused terminal is follows.

T1, T4 : Short to ground

T2, T3 : Open

GC1, GC2 : Open

●Notes for use

- (1) Absolute Maximum Ratings
An excess in the absolute maximum ratings, such as supply voltage, temperature range of operating conditions, etc., can break down devices, thus making impossible to identify breaking mode such as a short circuit or an open circuit. If any special mode exceeding the absolute maximum ratings is assumed, consideration should be given to take physical safety measures including the use of fuses, etc.
- (2) Power supply and ground line
Design PCB pattern to provide low impedance for the wiring between the power supply and the ground lines. Pay attention to the interference by common impedance of layout pattern when there are plural power supplies and ground lines. Especially, when there are ground pattern for small signal and ground pattern for large current included the external circuits, please separate each ground pattern. Furthermore, for all power supply pins to ICs, mount a capacitor between the power supply and the ground pin. At the same time, in order to use a capacitor, thoroughly check to be sure the characteristics of the capacitor to be used present no problem including the occurrence of capacity dropout at a low temperature, thus determining the constant.
- (3) Ground voltage
Make setting of the potential of the ground pin so that it will be maintained at the minimum in any operating state. Furthermore, check to be sure no pins are at a potential lower than the ground voltage including an actual electric transient.
- (4) Short circuit between pins and erroneous mounting
In order to mount ICs on a set PCB, pay thorough attention to the direction and offset of the ICs. Erroneous mounting can break down the ICs. Furthermore, if a short circuit occurs due to foreign matters entering between pins or between the pin and the power supply or the ground pin, the ICs can break down.
- (5) Operation in strong electromagnetic field
Be noted that using ICs in the strong electromagnetic field can malfunction them.
- (6) Input pins
In terms of the construction of IC, parasitic elements are inevitably formed in relation to potential. The operation of the parasitic element can cause interference with circuit operation, thus resulting in a malfunction and then breakdown of the input pin. Therefore, pay thorough attention not to handle the input pins, such as to apply to the input pins a voltage lower than the ground respectively, so that any parasitic element will operate. Furthermore, do not apply a voltage to the input pins when no power supply voltage is applied to the IC. In addition, even if the power supply voltage is applied, apply to the input pins a voltage lower than the power supply voltage or within the guaranteed value of electrical characteristics.
- (7) External capacitor
In order to use a ceramic capacitor as the external capacitor, determine the constant with consideration given to a degradation in the nominal capacitance due to DC bias and changes in the capacitance due to temperature, etc.
- (8) Thermal shutdown circuit (TSD)
This LSI builds in a thermal shutdown (TSD) circuit. When junction temperatures become detection temperature or higher, the thermal shutdown circuit operates and turns a switch OFF. The thermal shutdown circuit, which is aimed at isolating the LSI from thermal runaway as much as possible, is not aimed at the protection or guarantee of the LSI. Therefore, do not continuously use the LSI with this circuit operating or use the LSI assuming its operation.
- (9) Thermal design
Perform thermal design in which there are adequate margins by taking into account the permissible dissipation (Pd) in actual states of use.
- (10) About the pin for the test, the un-use pin
Prevent a problem from being in the pin for the test and the un-use pin under the state of actual use. Please refer to a function manual and an application notebook. And, as for the pin that doesn't specially have an explanation, ask our company person in charge.
- (11) About the rush current
For ICs with more than one power supply, it is possible that rush current may flow instantaneously due to the internal powering sequence and delays. Therefore, give special consideration to power coupling capacitance, power wiring, width of ground wiring, and routing of wiring.
- (12) About the function description or application note or more.
The function description and the application notebook are the design materials to design a set. So, the contents of the materials aren't always guaranteed. Please design application by having fully examination and evaluation include the external elements.

●Power dissipation (On the ROHM's Power dissipation measuring board)

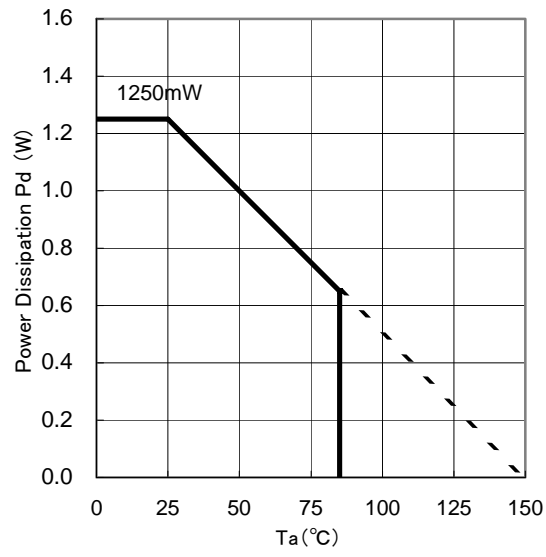

●Ordering part number

B	D
---	---

Part No.

6	0	9	1	0
---	---	---	---	---

Part No.

G	U
---	---

Package
GU: VCSP85H3

E	2
---	---

Packaging and forming specification
E2: Embossed tape and reel

VCSP85H3 (BD60910GU)

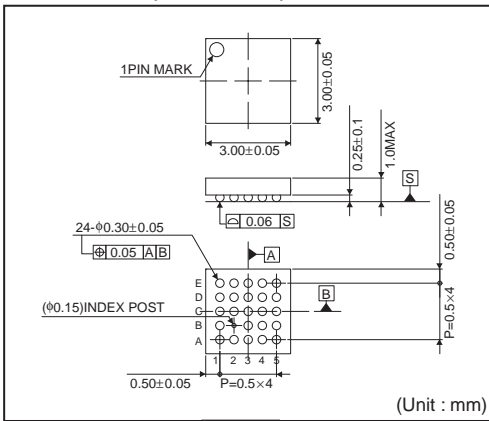

<Tape and Reel information>

Tape	Embossed carrier tape (heat sealing method)
Quantity	2500pcs
Direction of feed	E2 (The direction is the 1pin of product is at the upper left when you hold reel on the left hand and you pull out the tape on the right hand)

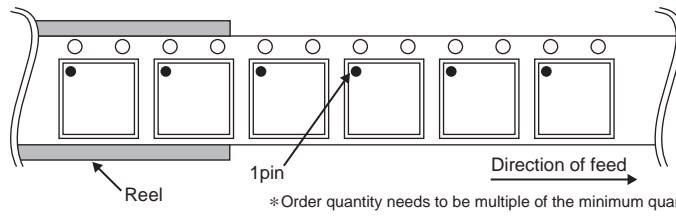

Notice

Precaution on using ROHM Products

- Our Products are designed and manufactured for application in ordinary electronic equipments (such as AV equipment, OA equipment, telecommunication equipment, home electronic appliances, amusement equipment, etc.). If you intend to use our Products in devices requiring extremely high reliability (such as medical equipment ^(Note 1), transport equipment, traffic equipment, aircraft/spacecraft, nuclear power controllers, fuel controllers, car equipment including car accessories, safety devices, etc.) and whose malfunction or failure may cause loss of human life, bodily injury or serious damage to property ("Specific Applications"), please consult with the ROHM sales representative in advance. Unless otherwise agreed in writing by ROHM in advance, ROHM shall not be in any way responsible or liable for any damages, expenses or losses incurred by you or third parties arising from the use of any ROHM's Products for Specific Applications.

(Note1) Medical Equipment Classification of the Specific Applications

JAPAN	USA	EU	CHINA
CLASS III	CLASS III	CLASS II b	CLASS III
CLASS IV		CLASS III	

- ROHM designs and manufactures its Products subject to strict quality control system. However, semiconductor products can fail or malfunction at a certain rate. Please be sure to implement, at your own responsibilities, adequate safety measures including but not limited to fail-safe design against the physical injury, damage to any property, which a failure or malfunction of our Products may cause. The following are examples of safety measures:
 - Installation of protection circuits or other protective devices to improve system safety
 - Installation of redundant circuits to reduce the impact of single or multiple circuit failure
- Our Products are designed and manufactured for use under standard conditions and not under any special or extraordinary environments or conditions, as exemplified below. Accordingly, ROHM shall not be in any way responsible or liable for any damages, expenses or losses arising from the use of any ROHM's Products under any special or extraordinary environments or conditions. If you intend to use our Products under any special or extraordinary environments or conditions (as exemplified below), your independent verification and confirmation of product performance, reliability, etc. prior to use, must be necessary:
 - Use of our Products in any types of liquid, including water, oils, chemicals, and organic solvents
 - Use of our Products outdoors or in places where the Products are exposed to direct sunlight or dust
 - Use of our Products in places where the Products are exposed to sea wind or corrosive gases, including Cl₂, H₂S, NH₃, SO₂, and NO₂
 - Use of our Products in places where the Products are exposed to static electricity or electromagnetic waves
 - Use of our Products in proximity to heat-producing components, plastic cords, or other flammable items
 - Sealing or coating our Products with resin or other coating materials
 - Use of our Products without cleaning residue of flux (even if you use no-clean type fluxes, cleaning residue of flux is recommended); or Washing our Products by using water or water-soluble cleaning agents for cleaning residue after soldering
 - Use of the Products in places subject to dew condensation
- The Products are not subject to radiation-proof design.
- Please verify and confirm characteristics of the final or mounted products in using the Products.
- In particular, if a transient load (a large amount of load applied in a short period of time, such as pulse. is applied, confirmation of performance characteristics after on-board mounting is strongly recommended. Avoid applying power exceeding normal rated power; exceeding the power rating under steady-state loading condition may negatively affect product performance and reliability.
- De-rate Power Dissipation (Pd) depending on Ambient temperature (Ta). When used in sealed area, confirm the actual ambient temperature.
- Confirm that operation temperature is within the specified range described in the product specification.
- ROHM shall not be in any way responsible or liable for failure induced under deviant condition from what is defined in this document.

Precaution for Mounting / Circuit board design

- When a highly active halogenous (chlorine, bromine, etc.) flux is used, the residue of flux may negatively affect product performance and reliability.
- In principle, the reflow soldering method must be used; if flow soldering method is preferred, please consult with the ROHM representative in advance.

For details, please refer to ROHM Mounting specification

Precautions Regarding Application Examples and External Circuits

1. If change is made to the constant of an external circuit, please allow a sufficient margin considering variations of the characteristics of the Products and external components, including transient characteristics, as well as static characteristics.
2. You agree that application notes, reference designs, and associated data and information contained in this document are presented only as guidance for Products use. Therefore, in case you use such information, you are solely responsible for it and you must exercise your own independent verification and judgment in the use of such information contained in this document. ROHM shall not be in any way responsible or liable for any damages, expenses or losses incurred by you or third parties arising from the use of such information.

Precaution for Electrostatic

This Product is electrostatic sensitive product, which may be damaged due to electrostatic discharge. Please take proper caution in your manufacturing process and storage so that voltage exceeding the Products maximum rating will not be applied to Products. Please take special care under dry condition (e.g. Grounding of human body / equipment / solder iron, isolation from charged objects, setting of ionizer, friction prevention and temperature / humidity control).

Precaution for Storage / Transportation

1. Product performance and soldered connections may deteriorate if the Products are stored in the places where:
 - [a] the Products are exposed to sea winds or corrosive gases, including Cl₂, H₂S, NH₃, SO₂, and NO₂
 - [b] the temperature or humidity exceeds those recommended by ROHM
 - [c] the Products are exposed to direct sunshine or condensation
 - [d] the Products are exposed to high Electrostatic
2. Even under ROHM recommended storage condition, solderability of products out of recommended storage time period may be degraded. It is strongly recommended to confirm solderability before using Products of which storage time is exceeding the recommended storage time period.
3. Store / transport cartons in the correct direction, which is indicated on a carton with a symbol. Otherwise bent leads may occur due to excessive stress applied when dropping of a carton.
4. Use Products within the specified time after opening a humidity barrier bag. Baking is required before using Products of which storage time is exceeding the recommended storage time period.

Precaution for Product Label

QR code printed on ROHM Products label is for ROHM's internal use only.

Precaution for Disposition

When disposing Products please dispose them properly using an authorized industry waste company.

Precaution for Foreign Exchange and Foreign Trade act

Since our Products might fall under controlled goods prescribed by the applicable foreign exchange and foreign trade act, please consult with ROHM representative in case of export.

Precaution Regarding Intellectual Property Rights

1. All information and data including but not limited to application example contained in this document is for reference only. ROHM does not warrant that foregoing information or data will not infringe any intellectual property rights or any other rights of any third party regarding such information or data. ROHM shall not be in any way responsible or liable for infringement of any intellectual property rights or other damages arising from use of such information or data.:
2. No license, expressly or implied, is granted hereby under any intellectual property rights or other rights of ROHM or any third parties with respect to the information contained in this document.

Other Precaution

1. This document may not be reprinted or reproduced, in whole or in part, without prior written consent of ROHM.
2. The Products may not be disassembled, converted, modified, reproduced or otherwise changed without prior written consent of ROHM.
3. In no event shall you use in any way whatsoever the Products and the related technical information contained in the Products or this document for any military purposes, including but not limited to, the development of mass-destruction weapons.
4. The proper names of companies or products described in this document are trademarks or registered trademarks of ROHM, its affiliated companies or third parties.

General Precaution

1. Before you use our Products, you are requested to carefully read this document and fully understand its contents. ROHM shall not be in any way responsible or liable for failure, malfunction or accident arising from the use of any ROHM's Products against warning, caution or note contained in this document.
2. All information contained in this document is current as of the issuing date and subject to change without any prior notice. Before purchasing or using ROHM's Products, please confirm the latest information with a ROHM sales representative.
3. The information contained in this document is provided on an "as is" basis and ROHM does not warrant that all information contained in this document is accurate and/or error-free. ROHM shall not be in any way responsible or liable for any damages, expenses or losses incurred by you or third parties resulting from inaccuracy or errors of or concerning such information.