

FEATURES

- Precision low voltage monitoring
- 9 reset threshold options: 1.58 V to 4.63 V
- 140 ms (min) reset timeout
- Watchdog timer with 1.6 sec timeout
- Manual reset input
- Reset output stages
 - Push-pull active-low
 - Open-drain active-low
 - Push-pull active-high
- Low power consumption (7 μ A)
- Guaranteed reset output valid to $V_{CC} = 1$ V
- Power supply glitch immunity
- Specified from -40°C to $+125^{\circ}\text{C}$
- 5-lead SOT-23 package

APPLICATIONS

- Microprocessor systems
- Computers
- Controllers
- Intelligent instruments
- Portable equipment

GENERAL DESCRIPTION

The ADM682x are supervisory circuits that monitor power supply voltage levels and code execution integrity in microprocessor-based systems. As well as providing power-on reset signals, an on-chip watchdog timer can reset the microprocessor if it fails to strobe within a preset timeout period. A reset signal can also be asserted by means of an external push-button through a manual reset input. The parts feature different combinations of watchdog input and manual reset input and output stage configurations, as shown in Table 1.

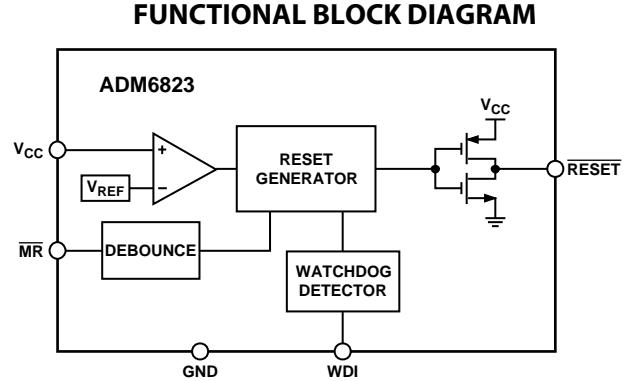

Figure 1.

Each part is available in nine reset threshold options, ranging from 1.58 V to 4.63 V. The reset and watchdog timeout periods are fixed at 140 ms (min) and 1.6 sec (typ), respectively.

The ADM682x are available in 5-lead SOT-23 packages and typically consume only 7 μ A, making them suitable for use in low power, portable applications.

Table 1. Selection Table

Part No.	Watchdog Timer	Manual Reset	Output Stage	
			RESET	RESET
ADM6821	Yes	Yes	-	Push-Pull
ADM6822	Yes	Yes	Open-Drain	-
ADM6823	Yes	Yes	Push-Pull	-
ADM6824	Yes	-	Push-Pull	Push-Pull
ADM6825	-	Yes	Push-Pull	Push-Pull

Rev. 0

Information furnished by Analog Devices is believed to be accurate and reliable. However, no responsibility is assumed by Analog Devices for its use, nor for any infringements of patents or other rights of third parties that may result from its use. Specifications subject to change without notice. No license is granted by implication or otherwise under any patent or patent rights of Analog Devices. Trademarks and registered trademarks are the property of their respective owners.

TABLE OF CONTENTS

Specifications.....	3	Watchdog Input	9
Absolute Maximum Ratings.....	5	Application Information.....	10
ESD Caution.....	5	Watchdog Input Current	10
Pin Configurations and Function Descriptions	6	Negative-Going V_{CC} Transients	10
Typical Performance Characteristics	7	Ensuring Reset Valid to $V_{CC} = 0 V$	10
Circuit Description.....	9	Watchdog Software Considerations.....	10
Reset Output	9	Outline Dimensions	11
Manual Reset Input	9	Ordering Guide	11

REVISION HISTORY

6/05—Revision 0: Initial Version

ADM6821/ADM6822/ADM6823/ADM6824/ADM6825

SPECIFICATIONS

$V_{CC} = 4.5\text{ V}$ to 5.5 V for ADM682_L/M; $V_{CC} = 2.7\text{ V}$ to 3.6 V for ADM682_T/S/R; $V_{CC} = 2.1\text{ V}$ to 2.75 V for ADM682_Z/Y; $V_{CC} = 1.53\text{ V}$ to 2.0 V for ADM682_W/V; $T_A = -40^\circ\text{C}$ to $+125^\circ\text{C}$, unless otherwise noted.

Table 2.

Parameter	Min	Typ	Max	Unit	Test Conditions/Comments
SUPPLY					
V_{CC} Operating Voltage Range	1		5.5	V	
Supply Current		10	20	μA	WDI and $\overline{\text{MR}}$ unconnected, $V_{CC} = 5.5\text{ V}$
		7	16	μA	WDI and $\overline{\text{MR}}$ unconnected, $V_{CC} = 3.6\text{ V}$
RESET THRESHOLD VOLTAGE					
ADM682xL	4.50	4.63	4.75	V	
ADM682xM	4.25	4.38	4.50	V	
ADM682xT	3.00	3.08	3.15	V	
ADM682xS	2.85	2.93	3.00	V	
ADM682xR	2.55	2.63	2.70	V	
ADM682xZ	2.25	2.32	2.38	V	
ADM682xY	2.12	2.19	2.25	V	
ADM682xW	1.62	1.67	1.71	V	
ADM682xV	1.52	1.58	1.62	V	
RESET THRESHOLD TEMPERATURE COEFFICIENT		60		ppm/ $^\circ\text{C}$	
RESET THRESHOLD HYSTERESIS		$2 \times V_{TH}$		mV	
V_{CC} TO RESET DELAY		20		μs	$V_{TH} - V_{CC} = 100\text{ mV}$
RESET TIMEOUT PERIOD	140	200	280	ms	
RESET Output Voltage					
V_{OL} (Push-Pull or Open-Drain)			0.3	V	$V_{CC} > = 1\text{ V}$, $I_{SINK} = 50\text{ }\mu\text{A}$
			0.3	V	$V_{CC} > = 1.2\text{ V}$, $I_{SINK} = 100\text{ }\mu\text{A}$
			0.3	V	$V_{CC} > = 2.55\text{ V}$, $I_{SINK} = 1.2\text{ mA}$
			0.4	V	$V_{CC} > = 4.25\text{ V}$, $I_{SINK} = 3.2\text{ mA}$
V_{OH} (Push-Pull Only)	$0.8 \times V_{CC}$			V	$V_{CC} > = 1.8\text{ V}$, $I_{SOURCE} = 200\text{ }\mu\text{A}$
	$0.8 \times V_{CC}$			V	$V_{CC} > = 3.15\text{ V}$, $I_{SOURCE} = 500\text{ }\mu\text{A}$
	$0.8 \times V_{CC}$			V	$V_{CC} > = 4.75\text{ V}$, $I_{SOURCE} = 800\text{ }\mu\text{A}$
RESET OUTPUT LEAKAGE CURRENT (Open-Drain Only)			1	μA	RESET not asserted
RESET OUTPUT VOLTAGE (Push-Pull Only)					
V_{OH}	$0.8 \times V_{CC}$			V	$V_{CC} > = 1\text{ V}$, $I_{SOURCE} = 1\text{ }\mu\text{A}$
	$0.8 \times V_{CC}$			V	$V_{CC} > = 1.5\text{ V}$, $I_{SOURCE} = 100\text{ }\mu\text{A}$
	$0.8 \times V_{CC}$			V	$V_{CC} > = 2.55\text{ V}$, $I_{SOURCE} = 500\text{ }\mu\text{A}$
	$0.8 \times V_{CC}$			V	$V_{CC} > = 4.25\text{ V}$, $I_{SOURCE} = 800\text{ }\mu\text{A}$
V_{OL}			0.3	V	$V_{CC} > = 1.8\text{ V}$, $I_{SINK} = 500\text{ }\mu\text{A}$
			0.3	V	$V_{CC} > = 3.15\text{ V}$, $I_{SINK} = 1.2\text{ mA}$
			0.4	V	$V_{CC} > = 4.75\text{ V}$, $I_{SINK} = 3.2\text{ mA}$
MANUAL RESET INPUT (ADM6821/ADM6822/ADM6823/ADM6825)					
$\overline{\text{MR}}$ Input Threshold			$0.3 \times V_{CC}$	V	
V_{IL}				V	
V_{IH}	$0.7 \times V_{CC}$			V	
$\overline{\text{MR}}$ Input Pulse Width	1			μs	
$\overline{\text{MR}}$ Glitch Rejection		100		ns	
$\overline{\text{MR}}$ to Reset Delay		200		ns	
$\overline{\text{MR}}$ Pull-Up Resistance	25	50	75	k Ω	

ADM6821/ADM6822/ADM6823/ADM6824/ADM6825

Parameter	Min	Typ	Max	Unit	Test Conditions/Comments
WATCHDOG INPUT (ADM6821/ADM6822/ADM6823/ADM6824)					
Watchdog Timeout Period	1.12	1.6	2.40	sec	
WDI Pulse Width	50			ns	
WDI Input Threshold					
V_{IL}			$0.3 \times V_{CC}$	V	
V_{IH}	$0.7 \times V_{CC}$			V	
WDI Input Current		120	160	μA	$V_{WDI} = V_{CC}$
	-20	-15		μA	$V_{WDI} = 0$

ABSOLUTE MAXIMUM RATINGS

T_A = 25°C, unless otherwise noted.

Table 3.

Parameter	Rating
V _{CC}	−0.3 V to +6 V
Output Current (RESET, $\overline{\text{RESET}}$)	20 mA
Operating Temperature Range	−40°C to +125°C
Storage Temperature Range	−65°C to +150°C
θ _{JA} Thermal Impedance	170°C/W
Soldering Temperature	
Sn/Pb	240°C, 30 sec
Pb-Free	260°C, 40 sec

Stresses above those listed under Absolute Maximum Ratings may cause permanent damage to the device. This is a stress rating only; functional operation of the device at these or any other conditions above those indicated in the operational section of this specification is not implied. Exposure to absolute maximum rating conditions for extended periods may affect device reliability.

ESD CAUTION

ESD (electrostatic discharge) sensitive device. Electrostatic charges as high as 4000 V readily accumulate on the human body and test equipment and can discharge without detection. Although this product features proprietary ESD protection circuitry, permanent damage may occur on devices subjected to high energy electrostatic discharges. Therefore, proper ESD precautions are recommended to avoid performance degradation or loss of functionality.



ADM6821/ADM6822/ADM6823/ADM6824/ADM6825

PIN CONFIGURATIONS AND FUNCTION DESCRIPTIONS

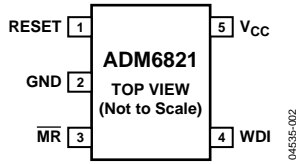

Figure 2. ADM6821 Pin Configuration

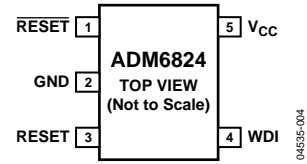

Figure 4. ADM6824 Pin Configuration

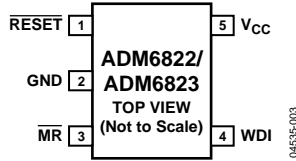

Figure 3. ADM6822/ADM6823 Pin Configuration

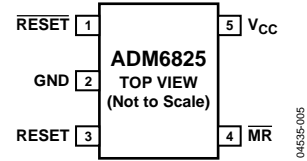

Figure 5. ADM6825 Pin Configuration

Table 4. Pin Function Descriptions

Pin No.	Name	Description
1	RESET (ADM6822/ADM6823/ADM6824/ADM6825)	Active-Low Reset Output. Asserted whenever V_{CC} is below the reset threshold, V_{TH} . Open-Drain Output Stage for the ADM6822. Push-Pull Output Stage for the ADM6823/ADM6824/ADM6825.
2	RESET (ADM6821) GND	Active-High Push-Pull Reset Output. Ground.
3	MR (ADM6821/ADM6822/ADM6823)	Manual Reset Input. This is an active-low input, which, when forced low for at least $1 \mu s$, generates a reset. It features a $50 k\Omega$ internal pull-up.
4	RESET (ADM6824/ADM6825) WDI (ADM6821/ADM6822/ADM6823/ADM6824)	Active-High Push-Pull Reset Output. Watchdog Input. Generates a reset if the voltage on the pin remains low or high for the duration of the watchdog timeout. The timer is cleared if a logic transition occurs on this pin or if a reset is generated.
5	MR (ADM6825) V_{CC}	Manual Reset Input. Power Supply Voltage Being Monitored.

TYPICAL PERFORMANCE CHARACTERISTICS

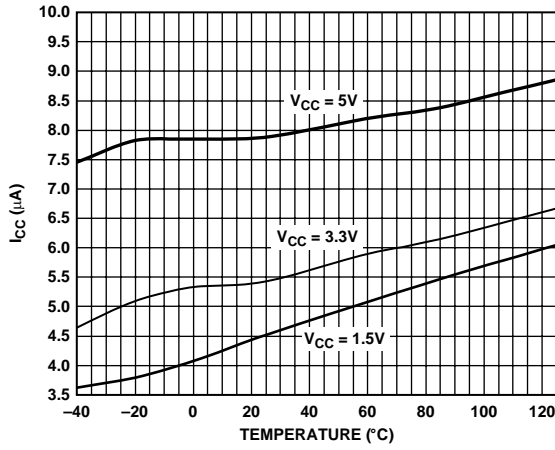

Figure 6. Supply Current vs. Temperature

04535-006

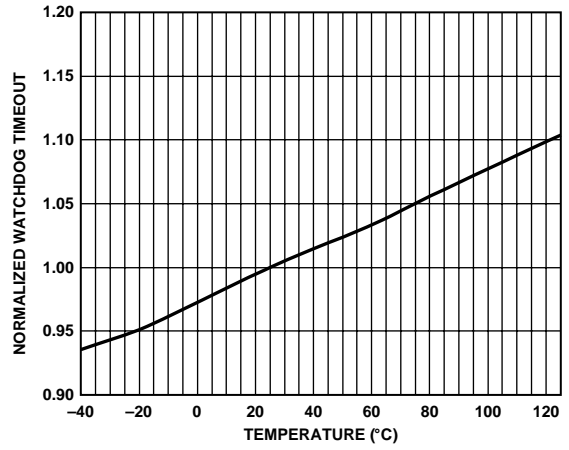

Figure 9. Normalized Watchdog Timeout Period vs. Temperature

04535-009

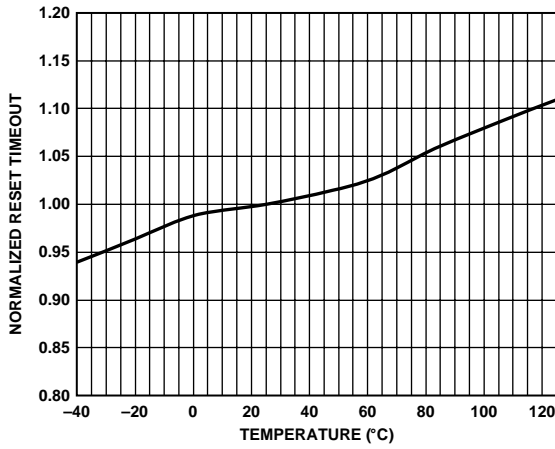

Figure 7. Normalized RESET Timeout Period vs. Temperature

04535-007

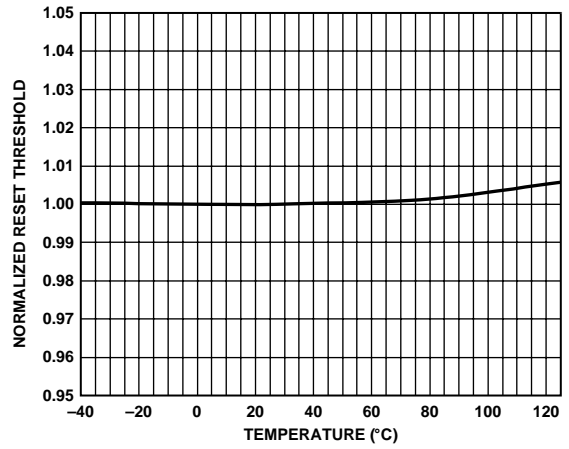

Figure 10. Normalized RESET Threshold vs. Temperature

04535-010

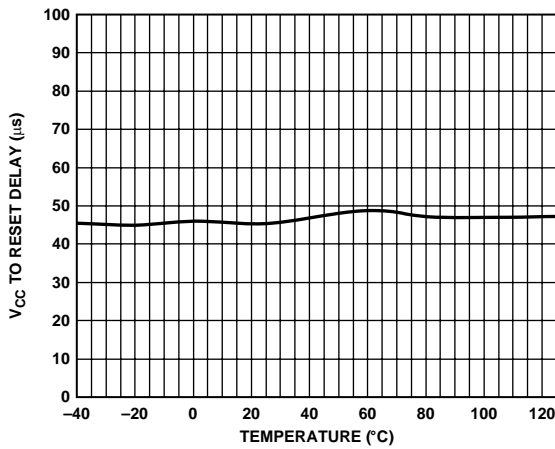

Figure 8. V_{CC} to RESET Output Delay vs. Temperature

04535-008

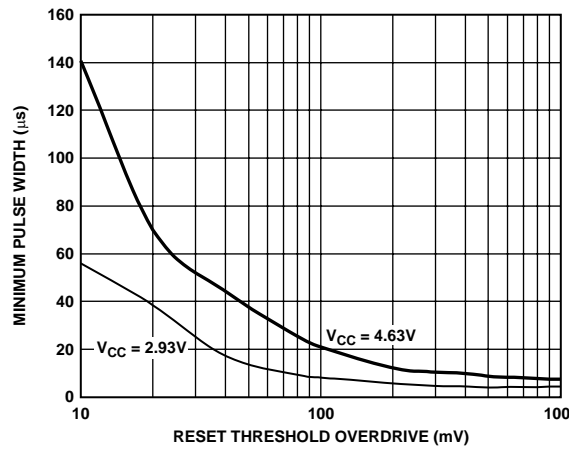

Figure 11. Maximum V_{CC} Transient Duration vs. RESET Threshold Overdrive

04535-011

ADM6821/ADM6822/ADM6823/ADM6824/ADM6825

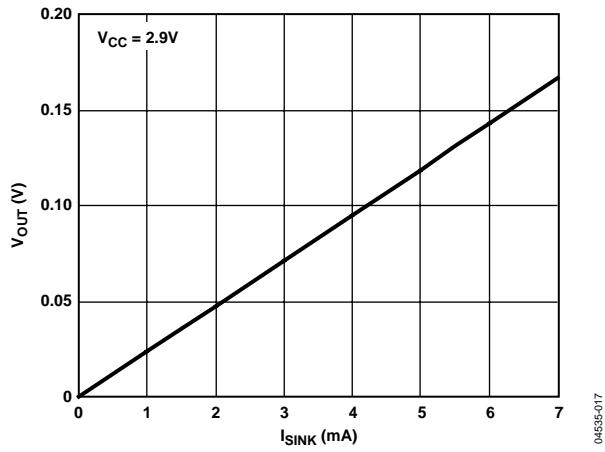

Figure 12. Voltage Output Low vs. I_{SINK}

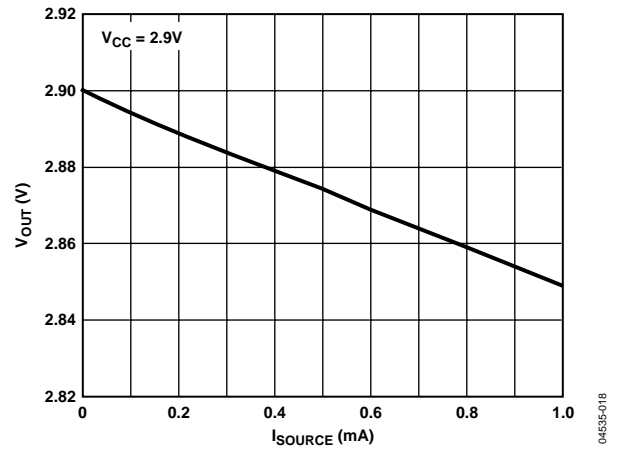

Figure 13. Voltage Output High vs. I_{SOURCE}

CIRCUIT DESCRIPTION

The ADM682x provide microprocessor supply voltage supervision by controlling the microprocessor's reset input. Code execution errors are avoided during power-up, power-down, and brownout conditions by asserting a reset signal when the supply voltage is below a preset threshold. In addition, the ADM682x allow supply voltage stabilization with a fixed timeout before the reset deasserts after the supply voltage rises above the threshold.

Problems with microprocessor code execution can be monitored and corrected with a watchdog timer (ADM6821/ADM6822/ADM6823/ADM6824). When watchdog strobe instructions are included in microprocessor code, a watchdog timer detects if the microprocessor code breaks down or becomes stuck in an infinite loop. If this happens, the watchdog timer asserts a reset pulse, which restarts the microprocessor in a known state.

If the user detects a problem with the system's operation, a manual reset input is available (ADM6821/ADM6822/ADM6823/ADM6825) to reset the microprocessor by means of an external push-button, for example.

RESET OUTPUT

The ADM6821 features an active-high push-pull reset output. The ADM6822 features an active-low open-drain reset output, while the ADM6823 features an active-low push-pull output. The ADM6824/ADM6825 feature dual active-low and active-high push-pull reset outputs. For active-low and active-high outputs, the reset signal is guaranteed to be logic low and logic high, respectively, for V_{CC} down to 1 V.

The reset output is asserted when V_{CC} is below the reset threshold (V_{TH}), when \overline{MR} is driven low, or when WDI is not serviced within the watchdog timeout period (t_{WD}). Reset remains asserted for the duration of the reset active timeout period (t_{RP}) after V_{CC} rises above the reset threshold, after \overline{MR} transitions from low to high, or after the watchdog timer times out. Figure 14 shows the reset outputs.

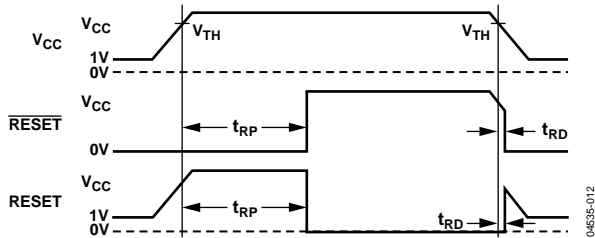

Figure 14. Reset Timing Diagram

MANUAL RESET INPUT

The ADM6821/ADM6822/ADM6823/ADM6825 feature a manual reset input (\overline{MR}), which, when driven low, asserts the reset output. When \overline{MR} transitions from low to high, reset remains asserted for the duration of the reset active timeout period before deasserting. The \overline{MR} input has a 50 k Ω internal pull-up so that the input is always high when unconnected. An external push-button switch can be connected between \overline{MR} and ground so that the user can generate a reset. Debounce circuitry is integrated on-chip for this purpose. Noise immunity is provided on the \overline{MR} input, and fast, negative-going transients of up to 100 ns (typ) are ignored. A 0.1 μ F capacitor between \overline{MR} and ground provides additional noise immunity.

WATCHDOG INPUT

The ADM6821/ADM6822/ADM6823/ADM6824 feature a watchdog timer, which monitors microprocessor activity. A timer circuit is cleared with every low-to-high or high-to-low logic transition on the watchdog input pin (WDI), which detects pulses as short as 50 ns. If the timer counts through the preset watchdog timeout period (t_{WD}), reset is asserted. The microprocessor is required to toggle the WDI pin to avoid being reset. Failure of the microprocessor to toggle WDI within the timeout period therefore indicates a code execution error, and the reset pulse generated restarts the microprocessor in a known state.

In addition to logic transitions on WDI, the watchdog timer is also cleared by a reset assertion due to an undervoltage condition on V_{CC} or \overline{MR} being pulled low. When reset is asserted, the watchdog timer is cleared and does not begin counting again until reset deasserts. The watchdog timer can be disabled by leaving WDI floating or by three-stating the WDI driver.

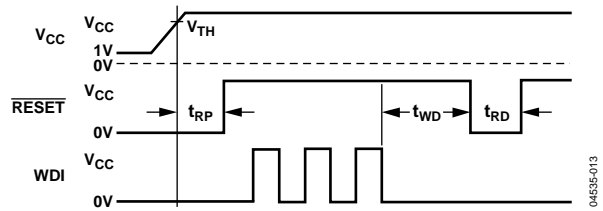

Figure 15. Watchdog Timing Diagram

APPLICATION INFORMATION

WATCHDOG INPUT CURRENT

To minimize watchdog input current (and minimize overall power consumption), leave WDI low for the majority of the watchdog timeout period. When driven high, WDI can draw as much as 160 μA . Pulsing WDI low-high-low at a low duty cycle reduces the effect of the large input current. When WDI is unconnected, a window comparator disconnects the watchdog timer from the reset output circuitry so that reset is not asserted when the watchdog timer times out.

NEGATIVE-GOING V_{CC} TRANSIENTS

To avoid unnecessary resets caused by fast power supply transients, the ADM682x are equipped with glitch rejection circuitry. The typical performance characteristic in Figure 11 plots V_{CC} transient duration versus the transient magnitude. The curves show combinations of transient magnitude and duration for which a reset is not generated for the 4.63 V and 2.93 V reset threshold parts. For example, with the 2.93 V threshold, a transient that goes 100 mV below the threshold and lasts 8 μs typically does not cause a reset, but if the transient is any bigger in magnitude or duration, a reset is generated. An optional 0.1 μF bypass capacitor mounted close to V_{CC} provides additional glitch rejection.

ENSURING RESET VALID TO $V_{CC} = 0\text{ V}$

Both active-low and active-high reset outputs are guaranteed to be valid for V_{CC} as low as 1 V. However, by using an external resistor with push-pull configured reset outputs, valid outputs for V_{CC} as low as 0 V are possible. For an active-low reset output, a resistor connected between $\overline{\text{RESET}}$ and ground pulls the output low when it is unable to sink current. For the active-high case, a resistor connected between RESET and V_{CC} pulls the output high when it is unable to source current. A large resistance such as 100 k Ω should be used so that it does not overload the reset output when V_{CC} is above 1 V.

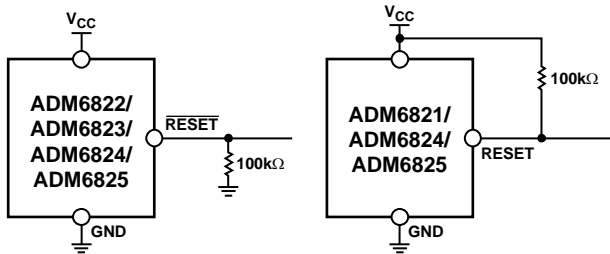

Figure 16. Ensuring Reset Valid to $V_{CC} = 0\text{ V}$

04535-015

WATCHDOG SOFTWARE CONSIDERATIONS

In implementing the microprocessor's watchdog strobe code, quickly switching WDI low-high and then high-low (minimizing WDI high time) is desirable for current consumption reasons. However, a more effective way of using the watchdog function can be considered.

A low-high-low WDI pulse within a given subroutine prevents the watchdog from timing out. However, if the subroutine becomes stuck in an infinite loop, the watchdog could not detect this because the subroutine continues to toggle WDI. A more effective coding scheme for detecting this error involves using a slightly longer watchdog timeout. In the program that calls the subroutine, WDI is set high. The subroutine sets WDI low when it is called. If the program executes without error, WDI is toggled high and low with every loop of the program. If the subroutine enters an infinite loop, WDI is kept low, the watchdog times out, and the microprocessor is reset.

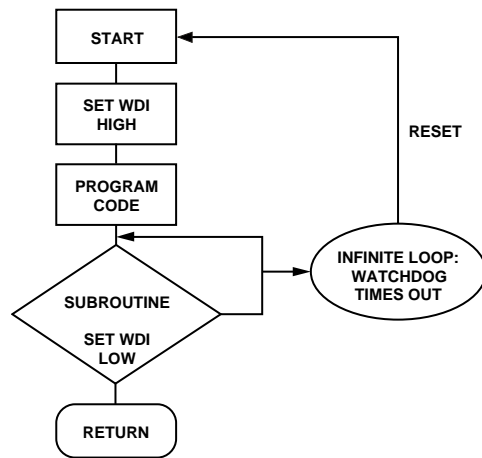

Figure 17. Watchdog Flow Diagram

04535-014

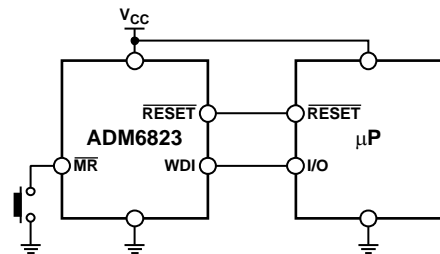
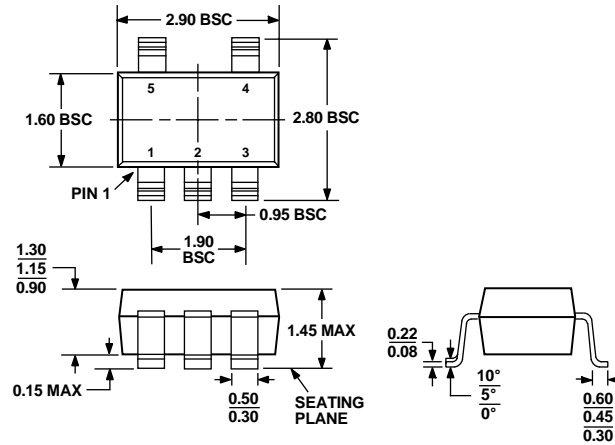

Figure 18. Typical Application Circuit

04535-016

ADM6821/ADM6822/ADM6823/ADM6824/ADM6825

OUTLINE DIMENSIONS



COMPLIANT TO JEDEC STANDARDS MO-178-AA

Figure 19. 5-Lead Small Outline Transistor Package [SOT-23] (RJ-5)

Dimensions shown in millimeters

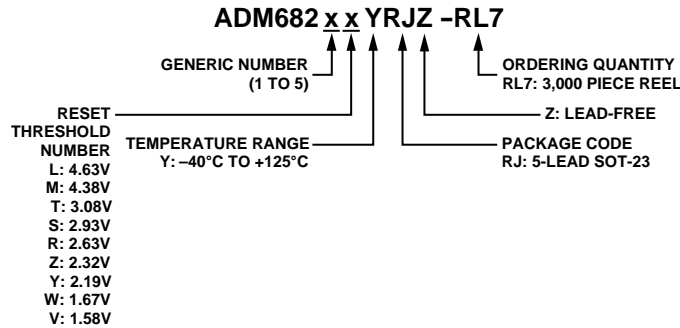

Figure 20. Ordering Code Structure

ORDERING GUIDE

Standard Models ¹	Reset Threshold (V)	Reset Timeout (ms)	Temperature Range	Quantity	Package Option	Branding
ADM6821SYRJZ-RL7 ²	2.93	140	-40°C to +125°C	3k	RJ-5	N0A
ADM6822SYRJZ-RL7 ²	2.93	140	-40°C to +125°C	3k	RJ-5	N0B
ADM6822TYRJZ-RL7 ²	3.08	140	-40°C to +125°C	3k	RJ-5	N0B
ADM6823SYRJ-R7	2.93	140	-40°C to +125°C	3k	RJ-5	N0C
ADM6823SYRJZ-RL7 ²	2.93	140	-40°C to +125°C	3k	RJ-5	N0Q
ADM6823TYRJ-R7	3.08	140	-40°C to +125°C	3k	RJ-5	N0C
ADM6823TYRJZ-RL7 ²	3.08	140	-40°C to +125°C	3k	RJ-5	N0Q
ADM6824TYRJZ-R7 ²	3.08	140	-40°C to +125°C	3k	RJ-5	N0D
ADM6825TYRJZ-R7 ²	3.08	140	-40°C to +125°C	3k	RJ-5	N0E

¹ If ordering nonstandard models, complete the ordering code shown in Figure 20 by inserting the part number and reset threshold suffixes. Contact Sales for availability of nonstandard models.

² Z = Pb-free part.

NOTES