

IMPORTANT NOTICE

Dear customer,

As of December 7th, 2015 BL RF Power of NXP Semiconductors will operate as an independent company under the new trade name Ampleon, which will be used in future data sheets together with new contact details.

In data sheets, where the previous Philips references is mentioned, please use the new links as shown below.

<http://www.philips.semiconductors.com> use <http://www.ampleon.com>

<http://www.semiconductors.philips.com> use <http://www.ampleon.com> (Internet)

sales.addresses@www.semiconductors.philips.com use
<http://www.ampleon.com/sales>

The copyright notice at the bottom of each page (or elsewhere in the document, depending on the version)

- © Koninklijke Philips Electronics N.V. (year). All rights reserved -
is replaced with:

- © Ampleon B.V. (year). All rights reserved. -

If you have any questions related to the data sheet, please contact our nearest sales office (details via <http://www.ampleon.com/sales>).

Thank you for your cooperation and understanding,

Ampleon

VHF push-pull power MOS transistor

BLF368

FEATURES

- High power gain
- Easy power control
- Good thermal stability
- Gold metallization ensures excellent reliability.

DESCRIPTION

Dual push-pull silicon N-channel enhancement mode vertical D-MOS transistor, designed for broadcast transmitter applications in the VHF frequency range.

The transistor is encapsulated in a 4-lead SOT262A1 balanced flange package, with two ceramic caps. The mounting flange provides the common source connection for the transistors.

PIN CONFIGURATION

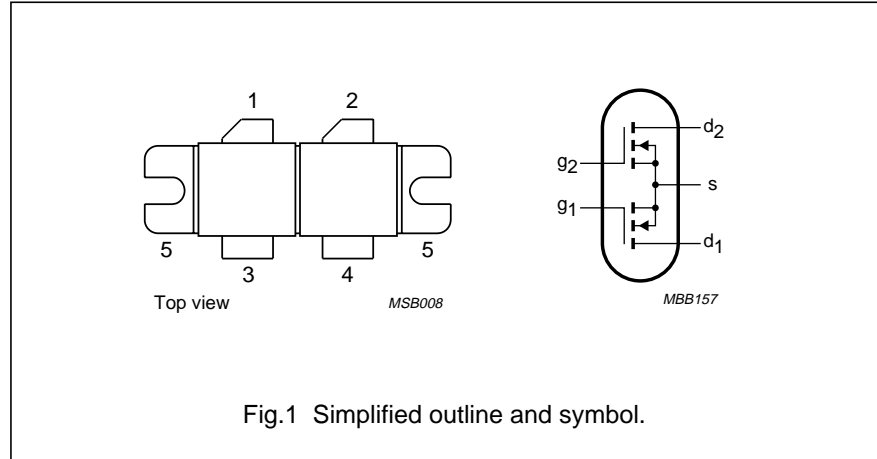

CAUTION

This product is supplied in anti-static packing to prevent damage caused by electrostatic discharge during transport and handling. For further information, refer to Philips specs.: SNW-EQ-608, SNW-FQ-302A, and SNW-FQ-302B.

PINNING - SOT262A1

PIN	DESCRIPTION
1	drain 1
2	drain 2
3	gate 1
4	gate 2
5	source

WARNING

Product and environmental safety - toxic materials

This product contains beryllium oxide. The product is entirely safe provided that the BeO discs are not damaged. All persons who handle, use or dispose of this product should be aware of its nature and of the necessary safety precautions. After use, dispose of as chemical or special waste according to the regulations applying at the location of the user. It must never be thrown out with the general or domestic waste.

QUICK REFERENCE DATA

RF performance at $T_h = 25\text{ °C}$ in a push-pull common source test circuit.

MODE OF OPERATION	f (MHz)	V_{DS} (V)	P_L (W)	G_p (dB)	ΔG_p (dB) (note 1)	η_D (%)
CW, class-AB	225	32	300	>12 typ. 13.5	>1 typ. 0.4	>55 typ. 62

Note

1. Assuming a third order amplitude transfer characteristic, 1 dB gain compression corresponds with 30% synchronized input/25% synchronized output compression in television service (negative modulation, CCIR system).

VHF push-pull power MOS transistor

BLF368

LIMITING VALUES

In accordance with the Absolute Maximum Rating System (IEC 60134).

SYMBOL	PARAMETER	CONDITIONS	MIN.	MAX.	UNIT
Per transistor section unless otherwise specified					
V _{DS}	drain-source voltage		–	65	V
V _{GS}	gate-source voltage		–	±20	V
I _D	drain current (DC)		–	25	A
P _{tot}	total power dissipation	T _{mb} ≤ 25 °C total device; both sections equally loaded	–	500	W
T _{stg}	storage temperature		–65	+150	°C
T _j	junction temperature		–	200	°C

THERMAL CHARACTERISTICS

SYMBOL	PARAMETER	CONDITIONS	VALUE	UNIT
R _{th j-mb}	thermal resistance from junction to mounting base	total device; both sections equally loaded	0.35	K/W
R _{th mb-h}	thermal resistance from mounting base to heatsink	total device; both sections equally loaded	0.15	K/W

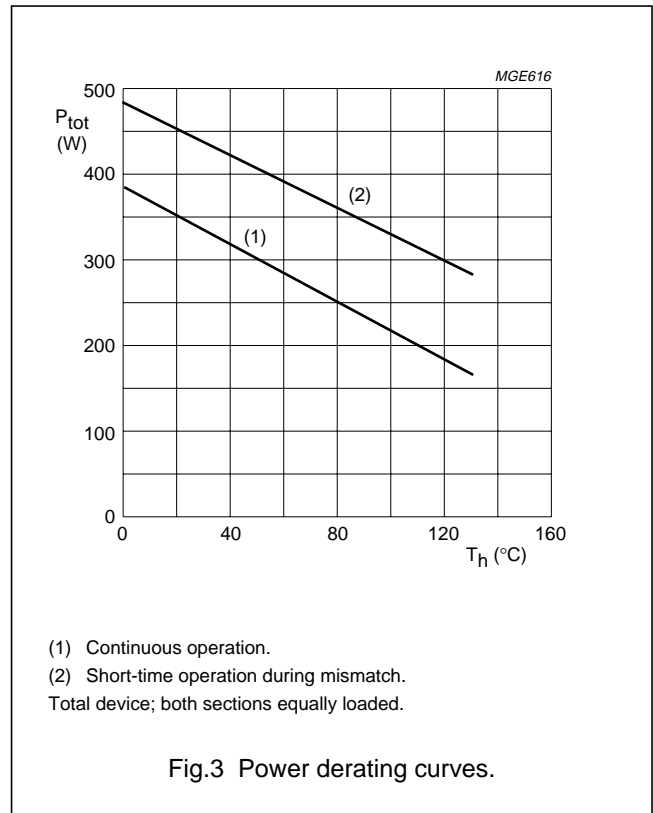
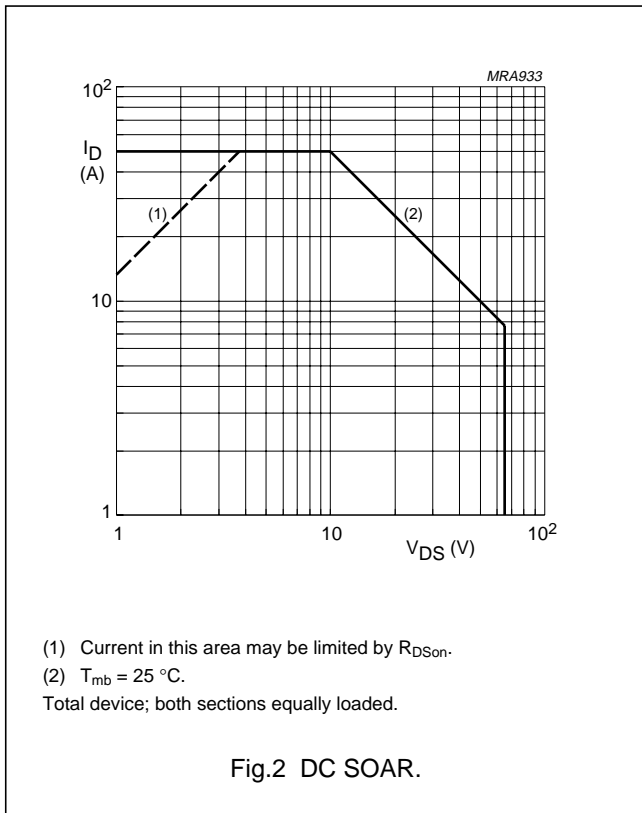

VHF push-pull power MOS transistor

BLF368

CHARACTERISTICS

 $T_j = 25\text{ }^\circ\text{C}$ unless otherwise specified.

SYMBOL	PARAMETERS	CONDITIONS	MIN.	TYP.	MAX.	UNIT
Per transistor section						
$V_{(BR)DSS}$	drain-source breakdown voltage	$V_{GS} = 0; I_D = 100\text{ mA}$	65	–	–	V
I_{DSS}	drain-source leakage current	$V_{GS} = 0; V_{DS} = 32\text{ V}$	–	–	5	mA
I_{GSS}	gate-source leakage current	$V_{GS} = \pm 20\text{ V}; V_{DS} = 0$	–	–	1	μA
V_{GSth}	gate-source threshold voltage	$I_D = 100\text{ mA}; V_{DS} = 10\text{ V}$	2	–	4.5	V
ΔV_{GS}	gate-source voltage difference of both transistor sections	$I_D = 100\text{ mA}; V_{DS} = 10\text{ V}$	–	–	100	mV
g_{fs}	forward transconductance	$I_D = 8\text{ A}; V_{DS} = 10\text{ V}$	5	7.5	–	S
g_{fs1}/g_{fs2}	forward transconductance ratio of both transistor sections	$I_D = 8\text{ A}; V_{DS} = 10\text{ V}$	0.9	–	1.1	
R_{DSon}	drain-source on-state resistance	$I_D = 8\text{ A}; V_{DS} = 10\text{ V}$	–	0.1	0.15	Ω
I_{DSX}	on-state drain current	$V_{GS} = 10\text{ V}; V_{DS} = 10\text{ V}$	–	37	–	A
C_{is}	input capacitance	$V_{GS} = 0; V_{DS} = 32\text{ V}; f = 1\text{ MHz}$	–	495	–	pF
C_{os}	output capacitance	$V_{GS} = 0; V_{DS} = 32\text{ V}; f = 1\text{ MHz}$	–	340	–	pF
C_{rs}	feedback capacitance	$V_{GS} = 0; V_{DS} = 32\text{ V}; f = 1\text{ MHz}$	–	40	–	pF
C_{d-f}	drain-flange capacitance		–	5.4	–	pF

 V_{GS} group indicator

GROUP	LIMITS (V)		GROUP	LIMITS (V)	
	MIN.	MAX.		MIN.	MAX.
A	2.0	2.1	O	3.3	3.4
B	2.1	2.2	P	3.4	3.5
C	2.2	2.3	Q	3.5	3.6
D	2.3	2.4	R	3.6	3.7
E	2.4	2.5	S	3.7	3.8
F	2.5	2.6	T	3.8	3.9
G	2.6	2.7	U	3.9	4.0
H	2.7	2.8	V	4.0	4.1
J	2.8	2.9	W	4.1	4.2
K	2.9	3.0	X	4.2	4.3
L	3.0	3.1	Y	4.3	4.4
M	3.1	3.2	Z	4.4	4.5
N	3.2	3.3			

VHF push-pull power MOS transistor

BLF368

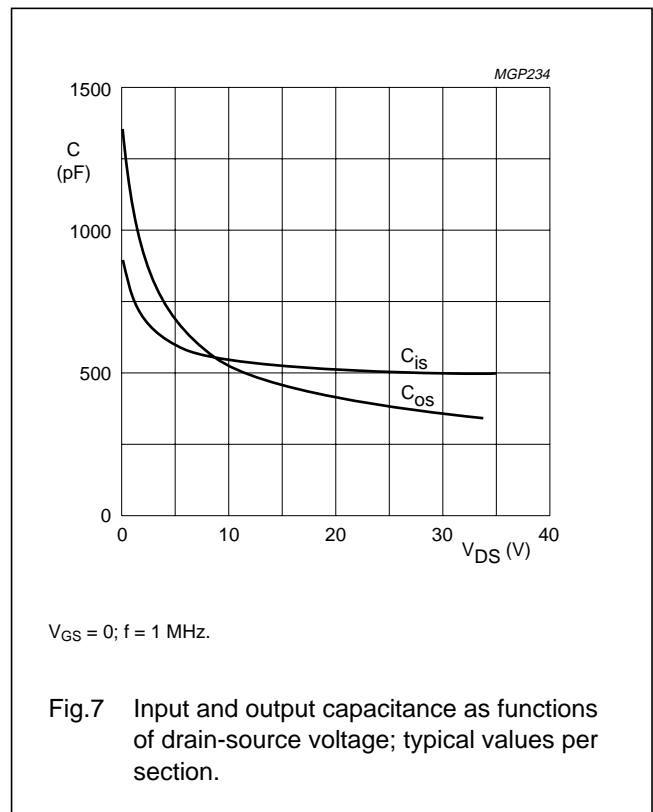
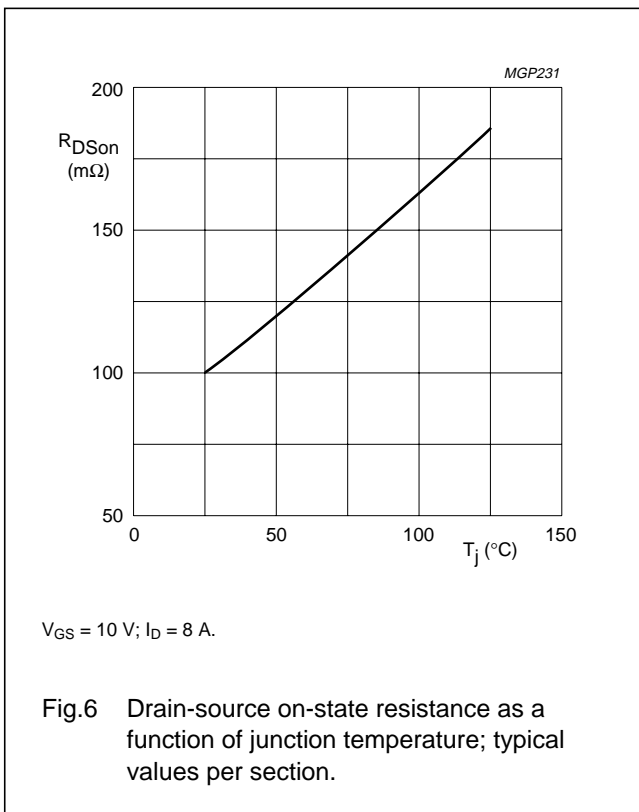
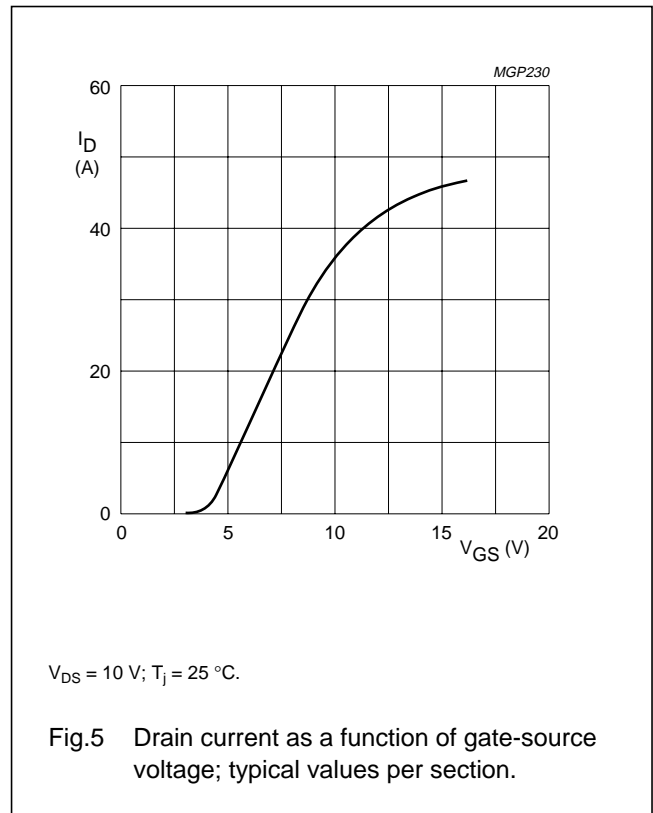
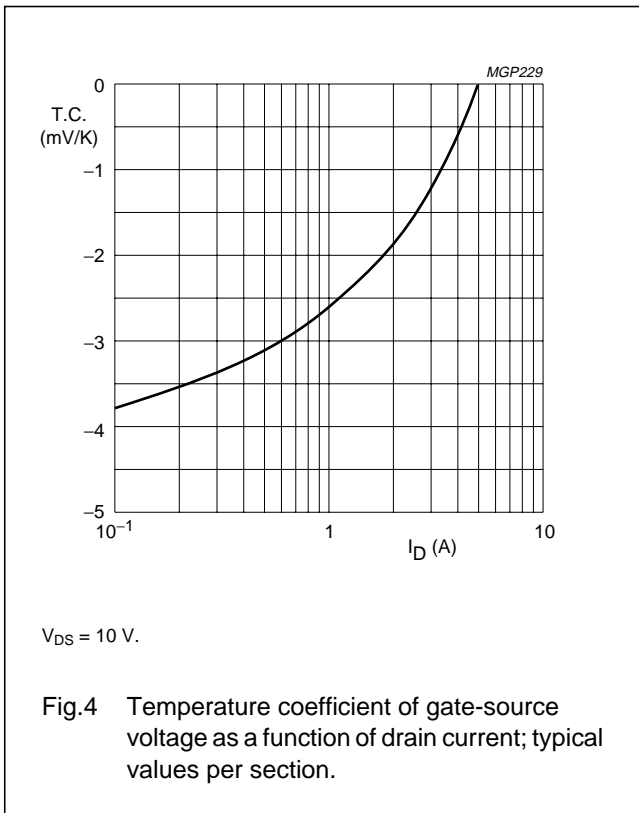

VHF push-pull power MOS transistor

BLF368

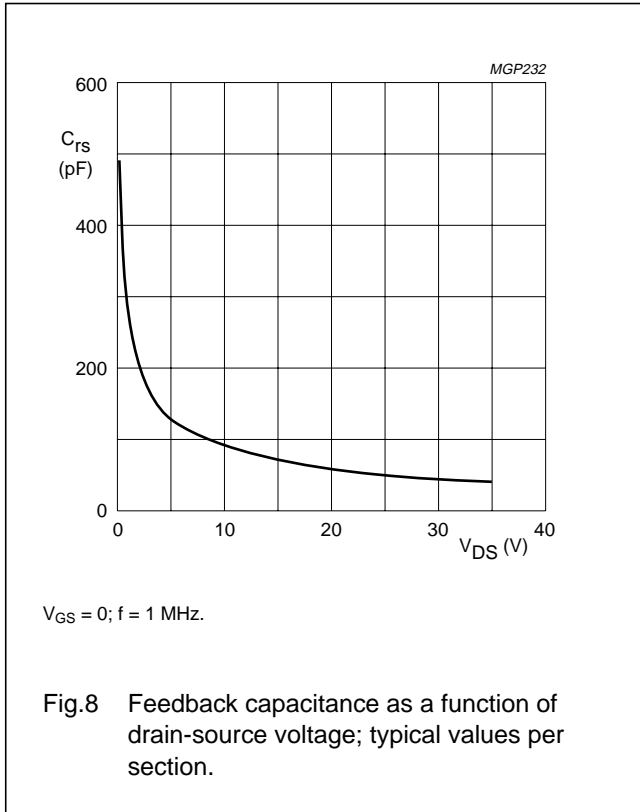

APPLICATION INFORMATION FOR CLASS-AB OPERATION

$T_h = 25 \text{ }^\circ\text{C}$; $R_{th\ mb-h} = 0.15 \text{ K/W}$ unless otherwise specified. RF performance in CW operation in a common source class-AB circuit. $R_{GS} = 536 \text{ } \Omega$ per section; optimum load impedance per section = $1.34 + j0.34 \text{ } \Omega$; $V_{DS} = 32 \text{ V}$.

MODE OF OPERATION	f (MHz)	V_{DS} (V)	I_{DQ} (mA)	P_L (W)	G_p (dB)	$\Delta G_p^{(1)}$ (dB)	η_D (%)
CW, class-AB	225	32	2×250	300	>12 typ. 13.5	>1 typ. 0.4	>55 typ. 62
	225	28	2×250	300	typ. 13	typ. 0.7	typ. 68
	225	35	2×250	300	typ. 14	typ. 0.2	typ. 60
	175	28	2×250	300	typ. 15	typ. 0.5	typ. 70

Note

- Assuming a third order amplitude transfer characteristic, 1 dB compression corresponds with 30% synchronized input/25% synchronized output compression in television service (negative modulation, CCIR system).

Ruggedness in class-AB operation

The BLF368 is capable of withstanding a load mismatch corresponding to $V_{SWR} = 10: 1$ through all phases under the following conditions: $V_{DS} = 32 \text{ V}$; $f = 225 \text{ MHz}$ at rated output power.

VHF push-pull power MOS transistor

BLF368

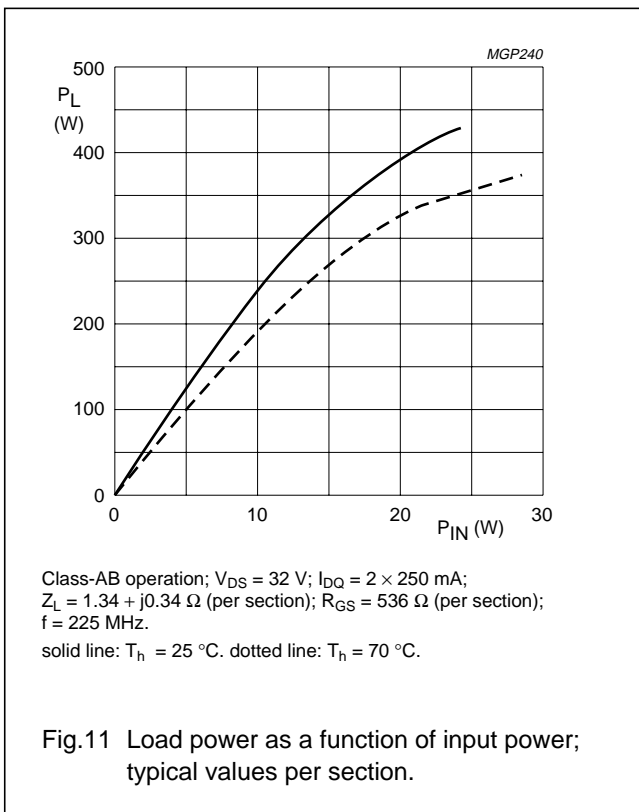
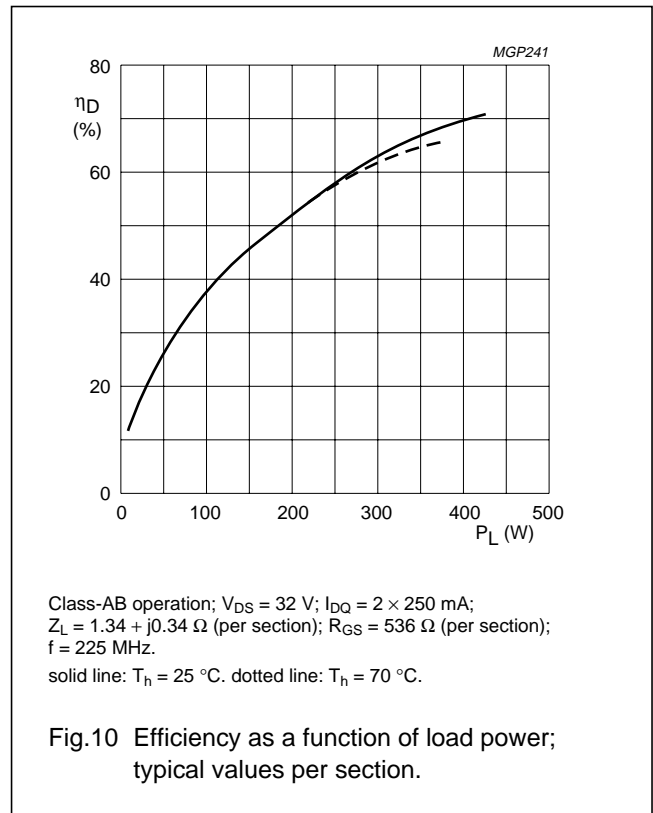
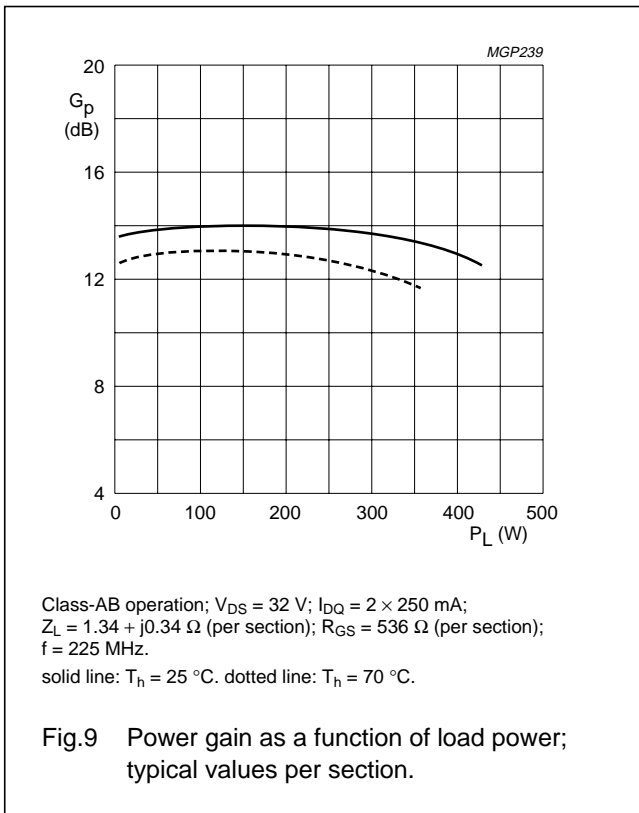

VHF push-pull power MOS transistor

BLF368

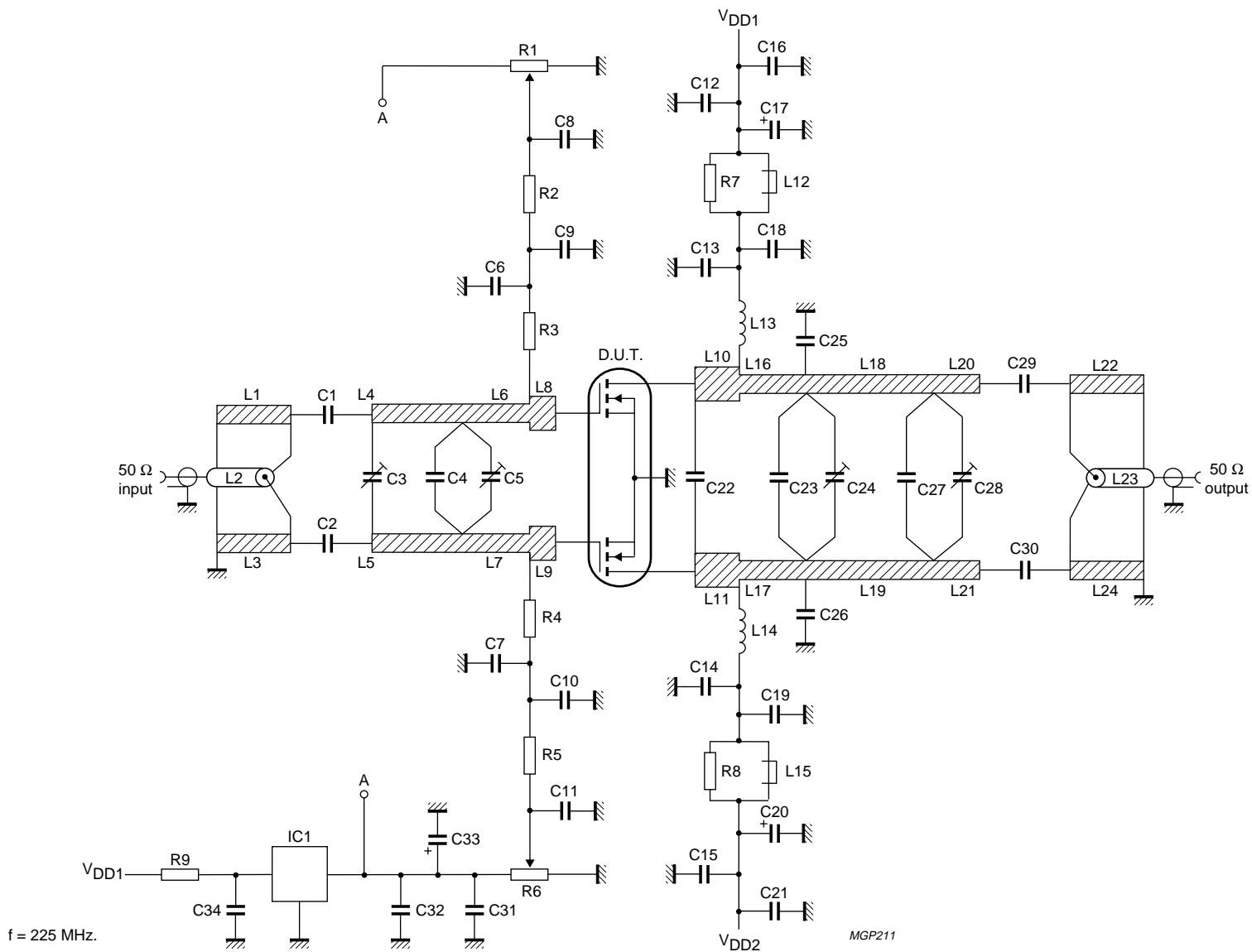

Fig.12 Test circuit for class-AB operation.

VHF push-pull power MOS transistor

BLF368

List of components class-AB test circuit (see Figs 12 and 13)

COMPONENT	DESCRIPTION	VALUE	DIMENSIONS	CATALOGUE NO.
C1, C2	multilayer ceramic chip capacitor; note 1	2 × 56 pF in parallel + 18 pF, 500 V		
C3	film dielectric trimmer	2 to 9 pF		2222 809 09005
C4	multilayer ceramic chip capacitor; note 1	47 pF, 500 V		
C5	film dielectric trimmer	5 to 60 pF		2222 809 08003
C6, C7, C9, C10, C12, C15, C31, C34	multilayer ceramic chip capacitor; note 1	1 nF, 500 V		2222 852 47104
C8, C11, C16, C21, C32	multilayer ceramic chip capacitor; note 1	100 nF, 50 V		
C17, C20, C33	electrolytic capacitor	10 µF, 63 V		
C22	multilayer ceramic chip capacitor; note 1	82 pF, 500 V		
C23	multilayer ceramic chip capacitor; note 1	10 pF + 30 pF in parallel, 500 V		
C24, C28	film dielectric trimmer	2 to 18 pF		2222 809 09006
C25, C26	multilayer ceramic chip capacitor; note 1	39 pF + 47 pF in parallel, 500 V		
C27	multilayer ceramic chip capacitor; note 1	18 pF, 500 V		
C29, C30	multilayer ceramic chip capacitor; note 1	3 × 100 pF in parallel, 500 V		
L1, L3, L22, L24	stripline; note 2	50 Ω	4.8 × 80 mm	
L2, L23	semi-rigid cable; note 3	50 Ω	ext. conductor length 80 mm ext. dia 3.6 mm	
L4, L5	stripline; note 2	43 Ω	6 × 32.5 mm	
L6, L7	stripline; note 2	43 Ω	6 × 10.5 mm	
L8, L9	stripline; note 2	43 Ω	6 × 3 mm	
L10, L11	stripline; note 2	43 Ω	6 × 10.5 mm	
L12, L15	grade 3B Ferroxcube wideband HF choke	2 in parallel		4312 020 36642
L13, L14	2 turns enamelled 1.6 mm copper wire	25 nH	space 2.5 mm int. dia. 5 mm leads 2 × 7 mm	
L16, L17	stripline; notes 2 and 4	43 Ω	6 × 3 mm	
L18, L19	stripline; notes 2 and 4	43 Ω	6 × 35 mm	
L20, L21	stripline; notes 2 and 4	43 Ω	6 × 9 mm	
R1, R6	10 turns potentiometer	50 kΩ		
R2, R5	metal film resistor	0.4 W, 1 kΩ		
R3, R4	metal film resistor	0.4 W, 536 Ω		

VHF push-pull power MOS transistor

BLF368

COMPONENT	DESCRIPTION	VALUE	DIMENSIONS	CATALOGUE NO.
R7, R8	metal film resistor	1 W, $\pm 5\%$, 10 Ω		
R9	metal film resistor	1 W, 3.16 k Ω		
IC1	voltage regulator 78L05			

Notes

1. American Technical Ceramics (ATC) capacitor, type 100B or other capacitor of the same quality.
2. The striplines L1, L3 to L11, L16 to L22 and L24 are on a double copper-clad printed circuit board with glass microfibre PTFE dielectric ($\epsilon_r = 2.2$); thickness $\frac{1}{16}$ inch; thickness of copper sheet $2 \times 35 \mu\text{m}$.
3. Semi-rigid cables L2 and L23 are soldered on to striplines L1 and L24.
4. A copper strap, thickness 0.8 mm, is soldered over the complete striplines L16 to L21 to avoid overheating by large RF currents.

VHF push-pull power MOS transistor

BLF368

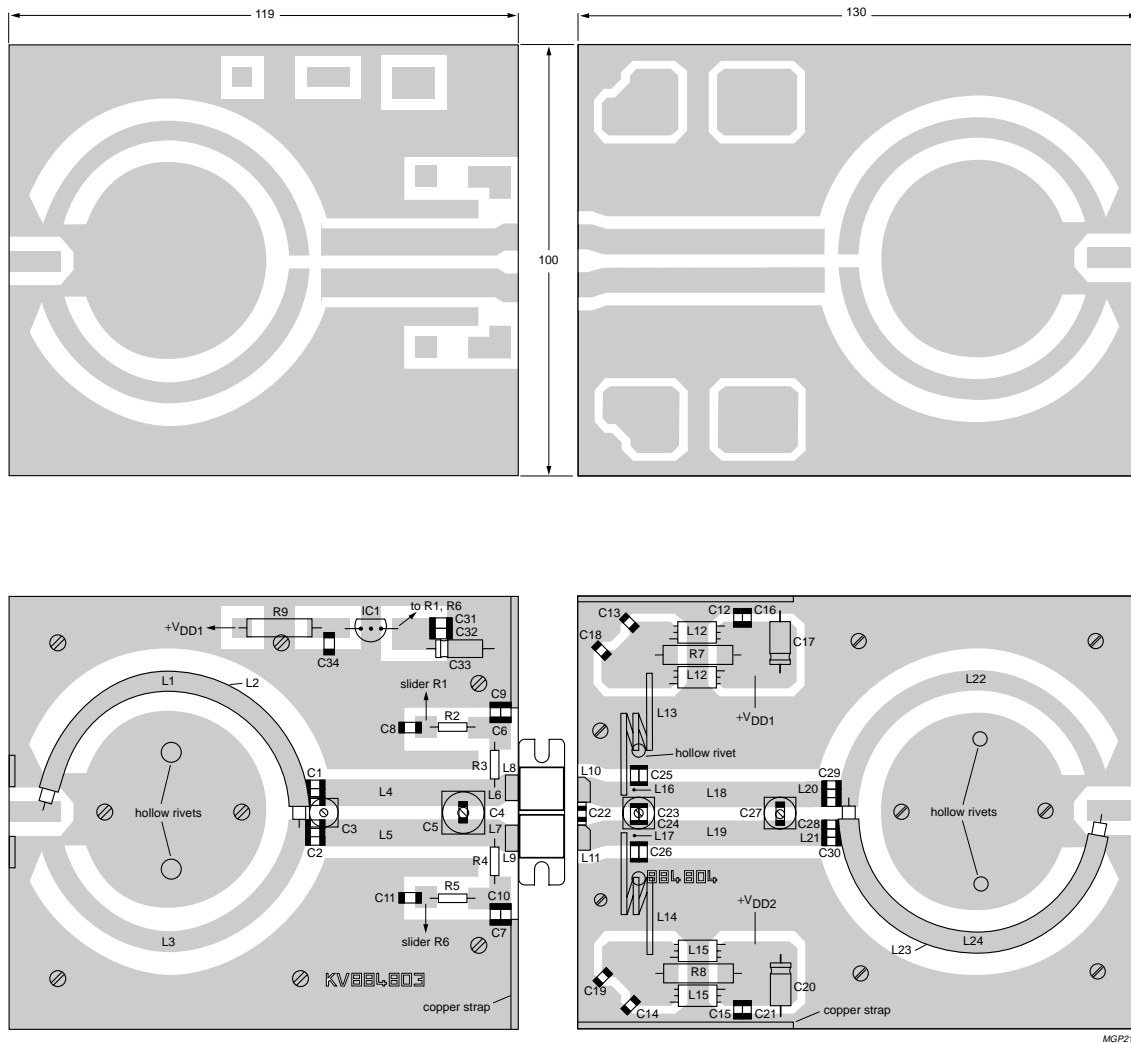

The circuit and components are situated on one side of the PTFE fibre-glass board, the other side being fully metallized, to serve as a ground plane. Earth connections are made by means of copper straps and hollow rivets for a direct contact between upper and lower sheets. Dimensions in mm.

Fig.13 Component layout for 225 MHz class-AB test circuit.

VHF push-pull power MOS transistor

BLF368

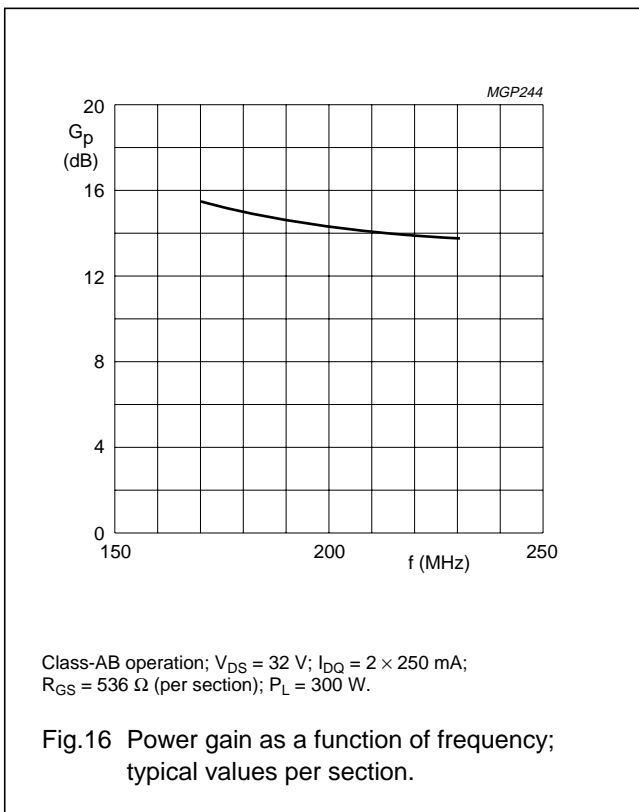
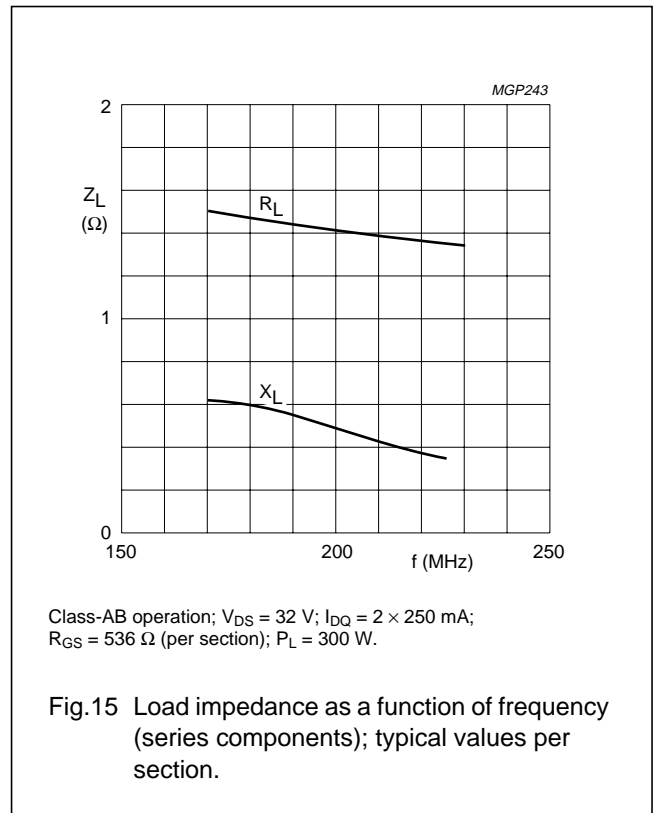
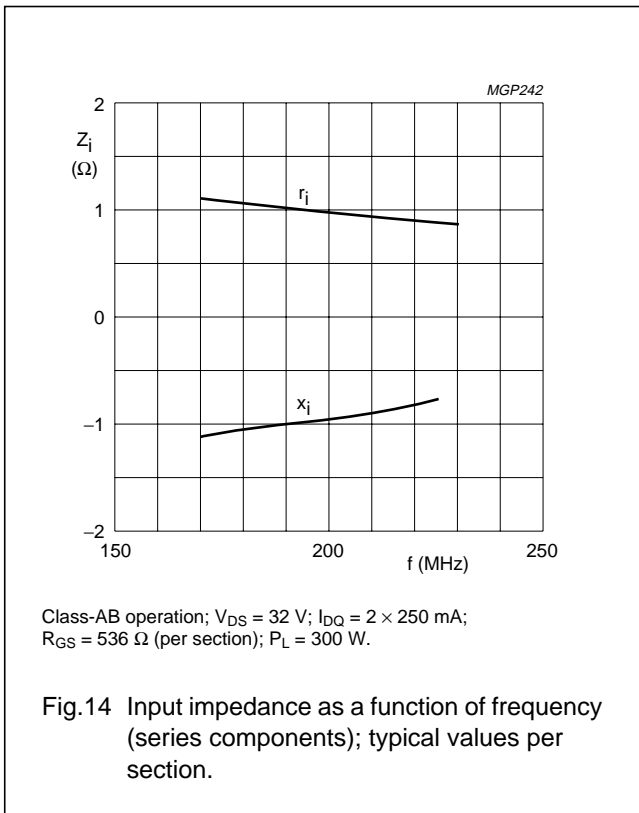

VHF push-pull power MOS transistor

BLF368

BLF368 scattering parameters $V_{DS} = 28\text{ V}$; $I_D = 250\text{ mA}$; note 1

f (MHz)	S ₁₁		S ₂₁		S ₁₂		S ₂₂	
	S ₁₁	∠ Φ	S ₂₁	∠ Φ	S ₁₂	∠ Φ	S ₂₂	∠ Φ
5	0.86	-159.2	21.94	96.8	0.01	-0.8	0.90	169.1
10	0.86	-168.9	11.14	88.5	0.01	21.1	0.85	174.3
20	0.86	-173.4	5.45	79.2	0.01	18.7	0.83	178.2
30	0.86	-174.2	3.53	72.3	0.02	8.7	0.83	-179.8
40	0.87	-174.4	2.54	66.3	0.02	0.3	0.84	-178.0
50	0.88	-174.5	1.94	61.0	0.02	-6.7	0.85	-176.7
60	0.90	-174.7	1.54	56.1	0.01	-12.5	0.86	-175.9
70	0.91	-174.9	1.25	51.8	0.01	-17.4	0.88	-175.4
80	0.92	-175.2	1.04	47.9	0.01	-21.1	0.89	-175.1
90	0.93	-175.5	0.88	44.4	0.01	-24.1	0.90	-175.0
100	0.93	-175.9	0.75	41.0	0.01	-26.6	0.91	-175.1
125	0.95	-176.7	0.53	34.0	0.01	-29.8	0.93	-175.6
150	0.96	-177.6	0.38	29.3	0.01	-28.2	0.94	-175.7
175	0.97	-178.4	0.30	25.8	0.00	-21.2	0.96	-176.1
200	0.97	-179.1	0.23	22.6	0.00	-6.2	0.97	-176.8
250	0.98	179.5	0.16	18.7	0.00	45.7	0.98	-177.7
300	0.99	178.4	0.11	17.1	0.01	70.9	0.99	-178.6
350	0.99	177.3	0.08	16.6	0.01	76.9	0.99	-179.2
400	0.99	176.4	0.07	18.9	0.01	84.9	0.99	-179.9
450	0.99	175.3	0.05	21.7	0.01	87.8	0.99	179.5
500	0.99	174.4	0.05	27.2	0.01	88.4	1.00	178.9
600	0.99	172.6	0.04	37.8	0.02	89.3	1.00	177.8
700	1.00	170.8	0.03	50.9	0.02	90.0	1.00	176.8
800	1.00	169.0	0.03	62.1	0.03	91.1	1.00	175.8
900	1.00	167.1	0.04	71.3	0.03	91.6	1.00	174.9
1000	1.00	165.1	0.04	76.4	0.04	92.3	1.00	173.8

Note

- For more extensive s-parameters see internet:
<http://www.semiconductors.philips.com/markets/communications/wirelesscommunications/broadcast>

VHF push-pull power MOS transistor

BLF368

BLF368 scattering parameters $V_{DS} = 32\text{ V}$; $I_D = 250\text{ mA}$; note 1

f (MHz)	S ₁₁		S ₂₁		S ₁₂		S ₂₂	
	S ₁₁	∠ Φ	S ₂₁	∠ Φ	S ₁₂	∠ Φ	S ₂₂	∠ Φ
5	0.86	-157.9	23.11	97.5	0.01	-2.1	0.90	168.6
10	0.86	-168.3	11.76	88.9	0.01	20.9	0.84	174.0
20	0.86	-173.1	5.75	79.4	0.01	18.7	0.82	178.1
30	0.86	-174.0	3.73	72.5	0.02	8.8	0.83	-179.7
40	0.87	-174.3	2.68	66.5	0.02	0.5	0.83	-177.9
50	0.88	-174.5	2.05	61.2	0.02	-6.5	0.84	-176.5
60	0.90	-174.6	1.63	56.4	0.01	-12.3	0.86	-175.7
70	0.91	-174.8	1.33	52.1	0.01	-17.1	0.87	-175.2
80	0.92	-175.2	1.10	48.2	0.01	-20.9	0.88	-174.8
90	0.93	-175.5	0.93	44.7	0.01	-23.9	0.89	-174.7
100	0.93	-175.8	0.80	41.4	0.01	-26.3	0.91	-174.8
125	0.95	-176.6	0.56	34.3	0.01	-29.5	0.92	-175.3
150	0.96	-177.5	0.41	29.5	0.01	-27.8	0.94	-175.5
175	0.97	-178.4	0.31	26.0	0.00	-20.8	0.96	-175.9
200	0.97	-179.1	0.25	22.8	0.00	-5.6	0.97	-176.6
250	0.98	179.6	0.16	18.9	0.00	45.9	0.98	-177.5
300	0.99	178.4	0.12	17.0	0.01	71.1	0.98	-178.4
350	0.99	177.3	0.09	16.9	0.01	77.4	0.99	-179.1
400	0.99	176.4	0.07	18.6	0.01	84.9	0.99	-179.8
450	0.99	175.4	0.06	21.2	0.01	87.9	0.99	179.7
500	0.99	174.4	0.05	24.8	0.01	88.5	1.00	179.0
600	0.99	172.6	0.04	36.3	0.02	89.4	1.00	177.9
700	1.00	170.8	0.03	49.2	0.02	90.1	1.00	176.9
800	1.00	169.0	0.03	61.2	0.03	91.2	1.00	175.9
900	1.00	167.1	0.04	70.4	0.03	91.8	1.00	175.0
1000	1.00	165.1	0.04	75.8	0.04	92.5	1.00	173.9

Note

- For more extensive s-parameters see internet:
<http://www.semiconductors.philips.com/markets/communications/wirelesscommunications/broadcast>

VHF push-pull power MOS transistor

BLF368

BLF368 scattering parameters $V_{DS} = 35\text{ V}$; $I_D = 250\text{ mA}$; note 1

f (MHz)	S ₁₁		S ₂₁		S ₁₂		S ₂₂	
	s ₁₁	∠ Φ	s ₂₁	∠ Φ	s ₁₂	∠ Φ	s ₂₂	∠ Φ
5	0.86	-156.9	23.97	98.1	0.01	-3.2	0.90	168.3
10	0.86	-167.8	12.21	89.2	0.01	20.7	0.84	173.8
20	0.86	-172.9	5.98	79.6	0.01	18.7	0.82	178.1
30	0.86	-173.9	3.88	72.7	0.01	8.9	0.82	-179.7
40	0.87	-174.2	2.79	66.7	0.02	0.6	0.82	-177.8
50	0.89	-174.4	2.13	61.4	0.02	-6.4	0.84	-176.4
60	0.90	-174.6	1.70	56.5	0.01	-12.2	0.85	-175.5
70	0.91	-174.8	1.38	52.2	0.01	-16.9	0.87	-175.0
80	0.92	-175.2	1.15	48.4	0.01	-20.8	0.88	-174.7
90	0.93	-175.5	0.97	44.9	0.01	-23.7	0.89	-174.5
100	0.93	-175.8	0.83	41.5	0.01	-26.0	0.90	-174.6
125	0.95	-176.6	0.58	34.5	0.01	-29.2	0.92	-175.1
150	0.96	-177.5	0.43	29.6	0.01	-27.6	0.94	-175.3
175	0.97	-178.3	0.33	26.1	0.00	-20.4	0.96	-175.7
200	0.97	-179.0	0.26	22.9	0.00	-5.1	0.96	-176.4
250	0.98	179.6	0.17	19.0	0.00	46.5	0.98	-177.3
300	0.99	178.4	0.12	16.9	0.01	71.2	0.98	-178.3
350	0.99	177.3	0.09	16.5	0.01	77.5	0.99	-179.0
400	0.99	176.4	0.07	18.1	0.01	84.9	0.99	-179.7
450	0.99	175.4	0.06	20.5	0.01	87.9	0.99	179.7
500	0.99	174.4	0.05	25.1	0.01	88.5	1.00	179.1
600	0.99	172.6	0.04	35.9	0.02	89.5	1.00	178.0
700	1.00	170.8	0.03	48.8	0.02	90.1	1.00	176.9
800	1.00	169.0	0.04	59.9	0.03	91.2	1.00	176.0
900	1.00	167.1	0.04	69.8	0.03	91.9	1.00	175.0
1000	1.00	165.1	0.04	75.8	0.04	92.6	1.00	173.9

Note

1. For more extensive s-parameters see internet:
<http://www.semiconductors.philips.com/markets/communications/wirelesscommunications/broadcast>

VHF push-pull power MOS transistor

BLF368

PACKAGE OUTLINE

Flanged double-ended ceramic package; 2 mounting holes; 4 leads

SOT262A1

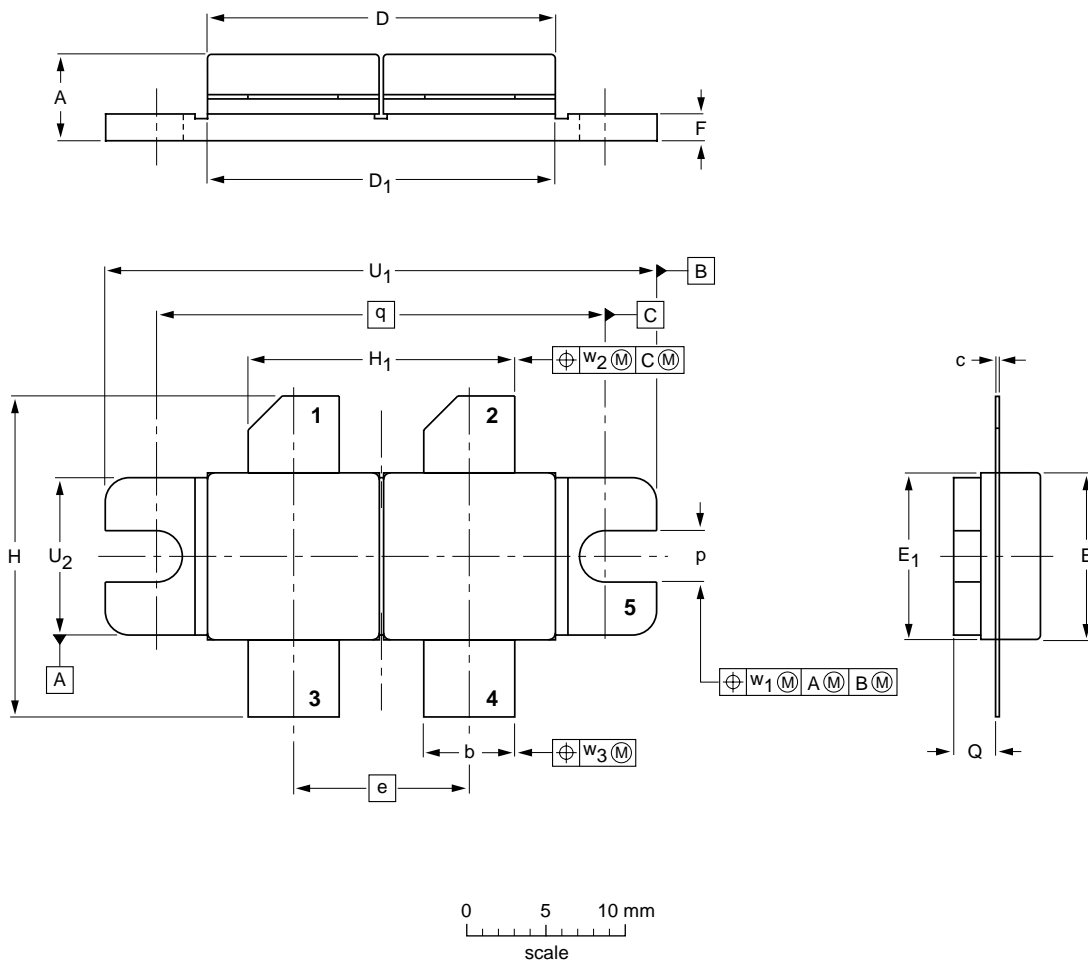

DIMENSIONS (millimetre dimensions are derived from the original inch dimensions)

UNIT	A	b	c	D	D ₁	e	E	E ₁	F	H	H ₁	p	Q	q	U ₁	U ₂	w ₁	w ₂	w ₃
mm	5.77 5.00	5.85 5.58	0.16 0.10	22.17 21.46	21.98 21.71	11.05	10.27 10.05	10.29 10.03	1.78 1.52	21.08 19.56	17.02 16.51	3.28 3.02	2.85 2.59	27.94	34.17 33.90	9.91 9.65	0.25	0.51	0.25
inches	0.227 0.197	0.230 0.220	0.006 0.004	0.873 0.845	0.865 0.855	0.435	0.404 0.396	0.405 0.396	0.070 0.060	0.830 0.770	0.670 0.650	0.129 0.119	0.112 0.102	1.100	1.345 1.335	0.390 0.380	0.010	0.020	0.010

OUTLINE VERSION	REFERENCES				EUROPEAN PROJECTION	ISSUE DATE
	IEC	JEDEC	EIAJ			
SOT262A1						99-03-29

VHF push-pull power MOS transistor

BLF368

DATA SHEET STATUS

LEVEL	DATA SHEET STATUS ⁽¹⁾	PRODUCT STATUS ⁽²⁾⁽³⁾	DEFINITION
I	Objective data	Development	This data sheet contains data from the objective specification for product development. Philips Semiconductors reserves the right to change the specification in any manner without notice.
II	Preliminary data	Qualification	This data sheet contains data from the preliminary specification. Supplementary data will be published at a later date. Philips Semiconductors reserves the right to change the specification without notice, in order to improve the design and supply the best possible product.
III	Product data	Production	This data sheet contains data from the product specification. Philips Semiconductors reserves the right to make changes at any time in order to improve the design, manufacturing and supply. Relevant changes will be communicated via a Customer Product/Process Change Notification (CPCN).

Notes

1. Please consult the most recently issued data sheet before initiating or completing a design.
2. The product status of the device(s) described in this data sheet may have changed since this data sheet was published. The latest information is available on the Internet at URL <http://www.semiconductors.philips.com>.
3. For data sheets describing multiple type numbers, the highest-level product status determines the data sheet status.

DEFINITIONS

Short-form specification — The data in a short-form specification is extracted from a full data sheet with the same type number and title. For detailed information see the relevant data sheet or data handbook.

Limiting values definition — Limiting values given are in accordance with the Absolute Maximum Rating System (IEC 60134). Stress above one or more of the limiting values may cause permanent damage to the device. These are stress ratings only and operation of the device at these or at any other conditions above those given in the Characteristics sections of the specification is not implied. Exposure to limiting values for extended periods may affect device reliability.

Application information — Applications that are described herein for any of these products are for illustrative purposes only. Philips Semiconductors make no representation or warranty that such applications will be suitable for the specified use without further testing or modification.

DISCLAIMERS

Life support applications — These products are not designed for use in life support appliances, devices, or systems where malfunction of these products can reasonably be expected to result in personal injury. Philips Semiconductors customers using or selling these products for use in such applications do so at their own risk and agree to fully indemnify Philips Semiconductors for any damages resulting from such application.

Right to make changes — Philips Semiconductors reserves the right to make changes in the products - including circuits, standard cells, and/or software - described or contained herein in order to improve design and/or performance. When the product is in full production (status 'Production'), relevant changes will be communicated via a Customer Product/Process Change Notification (CPCN). Philips Semiconductors assumes no responsibility or liability for the use of any of these products, conveys no licence or title under any patent, copyright, or mask work right to these products, and makes no representations or warranties that these products are free from patent, copyright, or mask work right infringement, unless otherwise specified.

Philips Semiconductors – a worldwide company

Contact information

For additional information please visit <http://www.semiconductors.philips.com>. Fax: +31 40 27 24825

For sales offices addresses send e-mail to: sales.addresses@www.semiconductors.philips.com.

© Koninklijke Philips Electronics N.V. 2003

SCA75

All rights are reserved. Reproduction in whole or in part is prohibited without the prior written consent of the copyright owner.

The information presented in this document does not form part of any quotation or contract, is believed to be accurate and reliable and may be changed without notice. No liability will be accepted by the publisher for any consequence of its use. Publication thereof does not convey nor imply any license under patent- or other industrial or intellectual property rights.

Printed in The Netherlands

613524/04/pp18

Date of release: 2003 Sep 26

Document order number: 9397 750 11602

Let's make things better.

**Philips
Semiconductors**



PHILIPS