

High Efficiency, Synchronous Step-Up & Down DC / DC Controller ICs

☆ Green Operation Compatible

■ GENERAL DESCRIPTION

The XC9303 series is highly efficient, synchronous PWM, PWM/PFM switchable step-up & down DC/DC controller ICs. A versatile, large output current and high efficiency, step-up/down DC/DC controller can be realized using only basic external components - transistors, coil, diode, capacitors, and resistors for detecting voltages. High efficiency is obtained through the use of a synchronous rectification topology. The operation of the XC9303 series can be switched between PWM and PWM/PFM (auto switching) externally using the PWM pin. In PWM/PFM mode, the XC9303 automatically switches from PWM to PFM during light loads and high efficiencies can be achieved over a wide range of output loads conditions. Output noise can be easily reduced with PWM control since the frequency is fixed. Synchronous rectification control can be switched to non-synchronous by using external signals (MODE pin). High efficiency can be regulated at heavy loads when synchronous operation. The XC9303 has a 0.9V ($\pm 2.0\%$) internal voltage supply and using externally connected components, output voltage can be set freely between 2.0V to 6.0V. With an internal 300kHz switching frequency smaller external components can be used. Soft-start time is internally set to 10ms and offers protection against in-rush currents when the power is switched on and prevents voltage overshoot.

■ APPLICATIONS

- PDAs
- Palmtop computers
- Portable audios
- Various power supplies

■ FEATURES

- Input Voltage Range** : 2.0V ~ 10V
- Output Voltage Range** : 2.0V ~ 6.0V
(set freely with $V_{FB}=0.9V$)
- Oscillation Frequency** : 300kHz ($\pm 15\%$)
- Output Current** : 800mA ($V_{IN} = 4.2V, V_{OUT}=3.3V$)
- Stand-By Function** : 3.0 μA (MAX.)
- Maximum Duty Cycle** : 78% (TYP.)
- High Efficiency** : 84% (TYP.)
- Soft-Start Time** : 10ms (internally fixed)
- Package** : MSOP-8A
- Environmentally Friendly:** EU RoHS Compliant, Pb Free

■ TYPICAL APPLICATION CIRCUIT

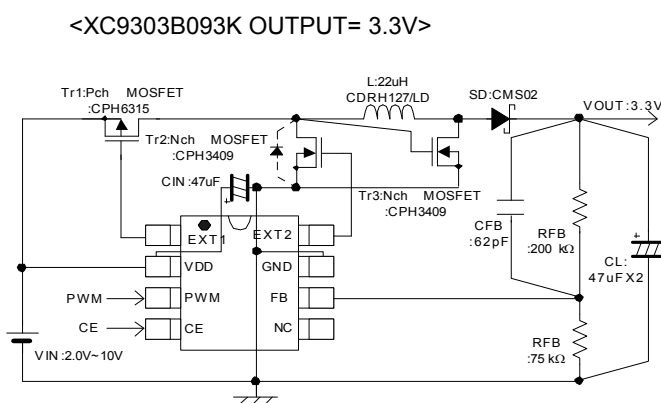

■ TYPICAL PERFORMANCE CHARACTERISTICS

- Efficiency vs. Output Current

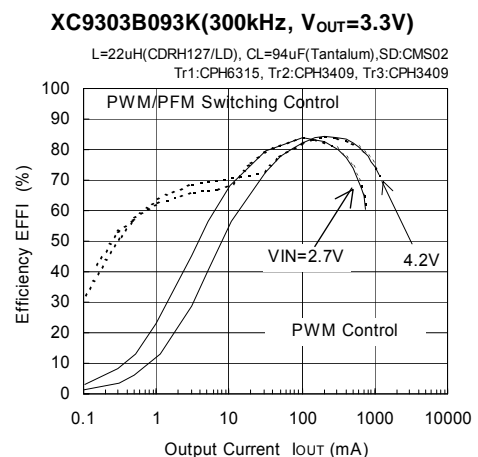

PIN CONFIGURATION

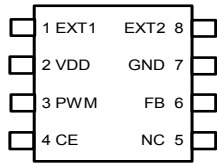

MSOP-8A
(TOP VIEW)

pletely: i ■

PIN NUMBER	PIN NAME	FUNCTIONS
1	EXT 1 /	External Transistor Drive Pin <Connected to High Side of P-ch Power MOSFET Gate>
2	VDD	Supply Voltage
3	PWM	PWM/PFM Switching Pin <PWM control when connected to VDD, PWM / PFM auto switching when connected to Ground. >
4	CE	Chip Enable Pin <Connected to Ground when output is stand-by mode. Connected to VDD when output is active. EXT/1 is high and EXT2/ is high when in stand-by mode. >
5	NC	No Connection
6	FB	Output Voltage Monitor Feedback Pin <Threshold value: 0.9V. Output voltage can be set freely by connecting split resistors between VOUT and Ground. >
7	GND	Ground
8	EXT2	External Transistor Drive Pin <Connected to Low side of N-ch Power MOSFET Gate>

PRODUCT CLASSIFICATION

Ordering Information

XC9303①②③④⑤⑥-⑦^(*)

DESIGNATOR	ITEM	SYMBOL	DESCRIPTION
①	Type of DC/DC Controller	B	Standard type
②③	Output Voltage	09	FB Voltage: 0.9V
④	Oscillation Frequency	3	300kHz
⑤⑥-⑦ ^(*)	Packages (Order Unit)	KR	MSOP-8A (1,000/Reel)
		KR-G	MSOP-8A (1,000/Reel)

^(*) The "-G" suffix denotes Halogen and Antimony free as well as being fully EU RoHS compliant.

■ BLOCK DIAGRAM

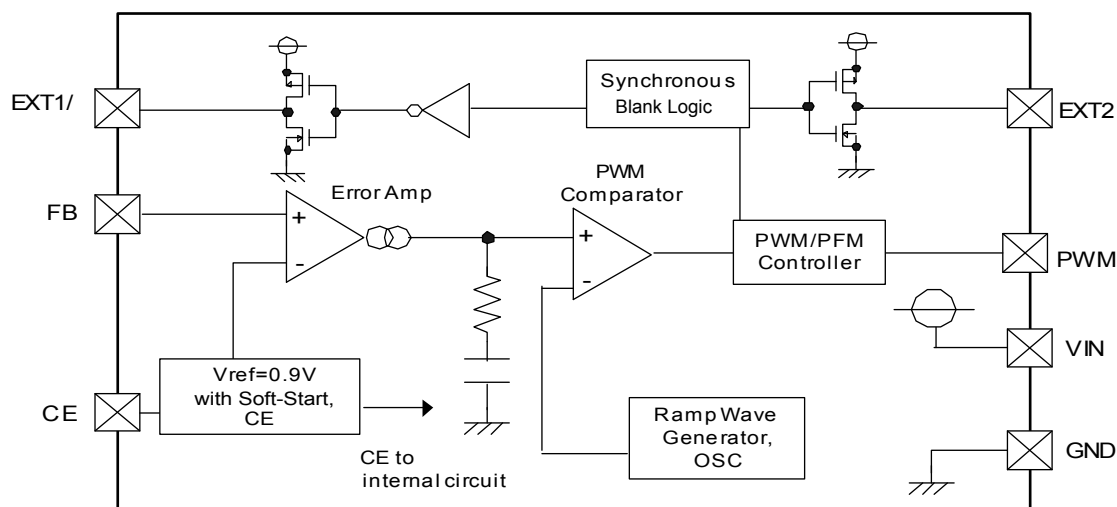

■ ABSOLUTE MAXIMUM RATINGS

Ta = 25°C

PARAMETER	SYMBOL	RATINGS	UNITS
VDD Pin Voltage	VDD	- 0.3 ~ 12.0	V
FB Pin Voltage	VFB	- 0.3 ~ 12.0	V
CE Pin Voltage	VEN	- 0.3 ~ 12.0	V
PWM Pin Voltage	VPWM	- 0.3 ~ 12.0	V
EXT1, 2 Pin Voltage	VEXT	- 0.3 ~ VDD + 0.3	V
EXT1, 2 Pin Current	IEXT	±100	mA
Power Dissipation	Pd	150	mW
Operating Ambient Temperature	Topr	- 40 ~ + 85	°C
Storage Temperature Range	Tstg	- 55 ~ +125	°C

ELECTRICAL CHARACTERISTICS

XC9303B093

(FOSC = 300kHz)

Ta=25°C

PARAMETER	SYMBOL	CONDITIONS	MIN.	TYP.	MAX.	UNITS	CIRCUIT
Supply Voltage	V _{DD}		2.0	-	10.0	V	①
Maximum Input Voltage	V _{IN}		10.0	-	-	V	①
Output Voltage Range (*1)	V _{OUTSET}	V _{IN} ≥ 2.0V, I _{OUT} =1mA V _{OUT}	2.0	-	6.0	V	①
Supply Current 1	I _{DD1}	FB = 0V	-	90	170	μA	②
Supply Current 2	I _{DD2}	FB = 1.0V	-	55	110	μA	②
Stand-by Current	I _{STB}	Same as I _{DD1} , CE = 0V	-	-	3.0	μA	②
Oscillation Frequency	FOSC	Same as I _{DD1}	255	300	345	kHz	②
FB Voltage	V _{FB}	V _{IN} =3.0V, I _{OUT} =10mA	0.882	0.900	0.918	V	③
Minimum Operation Voltage	V _{INmin}		-	-	2.0	V	①
Maximum Duty Ratio	MAXDTY	Same as I _{DD1}	72	78	88	%	②
Minimum Duty Ratio	MINDTY	Same as I _{DD2}	-	-	0	%	②
PFM Duty Ratio	PFMDTY	No Load, V _{PWM} =0V	22	30	38	%	④
Efficiency (*2)	EFFI	I _{OUT1} =100mA (*3)	-	84	-	%	④
Soft-Start Time	TSS	V _{OUT} × 0.95V, CE=0V → 0.65V	5.0	10.0	20.0	ms	④
EXT1 "High" ON Resistance	R _{EXTBH1}	CE = 0, EXT1 = V _{DD} - 0.4V	-	26	37	Ω	⑤
EXT1 "Low" ON Resistance	R _{EXTBL1}	FB = 0V, EXT1 = 0.4V	-	19	30	Ω	⑤
EXT2 "High" ON Resistance	R _{EXTBH2}	EXT2 = V _{DD} - 0.4V	-	23	31	Ω	⑤
EXT2 "Low" ON Resistance	R _{EXTBL2}	CE = 0V, EXT2 = V _{DD} - 0.4V	-	19	30	Ω	⑤
PWM "High" Voltage	V _{PWMH}	No Load	0.65	-	-	V	④
PWM "Low" Voltage	V _{PWML}	No Load	-	-	0.20	V	④
CE "High" Voltage	V _{CEH}	FB = 0V	0.65	-	-	V	②
CE "Low" Voltage	V _{CEL}	FB = 0V	-	-	0.2	V	②
CE "High" Current	I _{CEH}		-	-	0.5	μA	②
CE "Low" Current	I _{CEL}	CE = 0V	-	-	- 0.5	μA	②
PWM "High" Current	I _{PWMH}		-	-	0.5	μA	②
PWM "Low" Current	I _{PWML}	PWM=0V	-	-	- 0.5	μA	②
FB "High" Current	I _{FBH}		-	-	0.50	μA	②
FB "Low" Current	I _{FBL}	FB = 1.0V	-	-	- 0.50	μA	②

NOTE *1: Please be careful not to exceed the breakdown voltage level of the external components.

*2: $EFFI = \{ [(output\ voltage) \times (output\ current)] / [(input\ voltage) \times (input\ current)] \} \times 100$

*3: Tr1: CPH6315 (SANYO)
 Tr2: CPH3409 (SANYO)
 Tr3: CPH3409 (SANYO)
 SD: CMS02 (TOSHIBA)
 L: 22 μH (CDRH127/LD, SUMIDA)
 CL: 16V, 47 μF x 2 (Tantalum MCE Series, NICHICEMI)
 CIN: 16V, 47 μF (Tantalum MCE Series, NICHICEMI)
 R_{FB1}: 200k Ω
 R_{FB2}: 75k Ω
 C_{FB}: 62pF

■ OPERATIONAL EXPLANATION

The XC9303 series are synchronous step-up & down DC/DC converter controller ICs with built-in high speed, low ON resistance drivers.

<Error Amp.>

The error amplifier is designed to monitor the output voltage and it compares the feedback voltage (FB) with the reference voltage. In response to feedback of a voltage lower than the reference voltage, the output voltage of the error amp. decreases.

<OSC Generator>

This circuit generates the oscillation frequency, which in turn generates the source clock.

<Ramp Wave Generator>

The ramp wave generator generates a saw-tooth waveform based on outputs from the phase shift generator.

<PWM Comparator>

The PWM Comparator compares outputs from the error amp. and saw-tooth waveform. When the voltage from the error amp's output is low, the external switch will be set to ON.

<PWM/PFM Controller>

This circuit generates PFM pulses. Control can be switched between PWM control and PWM/PFM automatic switching control using external signals. The PWM/PFM automatic switching mode is selected when the voltage of the PWM pin is less than 0.2V, and the control switches between PWM and PFM automatically depending on the load. As the PFM circuit generates pulses based on outputs from the PWM comparator, shifting between modes occurs smoothly. PWM control mode is selected when the voltage of the PWM pin is more than 0.65V. Noise is easily reduced with PWM control since the switching frequency is fixed. Control suited to the application can easily be selected which is useful in audio applications, for example, where traditionally, efficiencies have been sacrificed during stand-by as a result of using PWM control (due to the noise problems associated with the PFM mode in stand-by).

<Synchronous, blank logic>

The synchronous, blank logic circuit is to prevent penetration of the transistor connected to EXT1 and EXT2.

<Vref with Soft Start>

The reference voltage, Vref (FB pin voltage)=0.9V, is adjusted and fixed by laser trimming (for output voltage settings, please refer to next page). To protect against inrush current, when the power is switched on, and also to protect against voltage overshoot, soft-start time is set internally to 10ms. It should be noted, however, that this circuit does not protect the load capacitor (CL) from inrush current. With the Vref voltage limited and depending upon the input to the error amps, the operation maintains a balance between the two inputs of the error amps and controls the EXT pin's ON time so that it doesn't increase more than is necessary.

<Chip Enable Function>

This function controls the operation and shutdown of the IC. When the voltage of the CE pin is 0.2V or less, the mode will be chip disable, the channel's operations will stop. The EXT1 pin will be kept at a high level (the external P-ch MOSFET will be OFF) and the EXT2 pin will be kept at a high level (the external N-ch MOSFET will be ON). When CE pin is in a state of chip disable, current consumption will be no more than 3.0 μA. When the CE pin's voltage is 0.65V or more, the mode will be chip enable and operations will recommence. With soft-start, 95% of the set output voltage will be reached within 10ms (TYP.) from the moment of chip enable.

<Output Voltage Setting>

Output voltage can be set by adding external split resistors. Output voltage is determined by the following equation, based on the values of RFB11 (RFB21) and RFB12 (RFB22). The sum of RFB11 (RFB21) and RFB12 (RFB22) should normally be 1 MΩ or less.

$$V_{OUT} = 0.9 \times (R_{FB11} + R_{FB12}) / R_{FB12}$$

The value of CFB1(CFB2), speed-up capacitor for phase compensation, should be $f_{zfb} = 1 / (2 \times \pi \times C_{FB1} \times R_{FB11})$ which is equal to 12kHz. Adjustments are required from 1kHz to 50kHz depending on the application, value of inductance (L), and value of load capacity (CL).

OPERATIONAL EXPLANATION (Continued)

<Output Voltage Setting (Continued)>

[Example of Calculation: When $R_{FB11} = 200k\Omega$ and $R_{FB12} = 75k\Omega$, $V_{OUT1} = 0.9 \times (200k + 75k) / 75k = 3.3V$.]

[Typical Example]

V _{OUT} (V)	R _{FB11} (kΩ)	R _{FB12} (kΩ)	C _{FB1} (pF)	V _{OUT} (V)	R _{FB11} (kΩ)	R _{FB12} (kΩ)	C _{FB1} (pF)
2.0	330	270	39	3.3	200	75	62
2.2	390	270	33	5.0	82	18	160
2.5	390	220	33				
2.7	360	180	33				
3.0	560	240	24				

[External Components]

Tr1: CPH6315 (P-ch MOSFET: SANYO), IRLMS6702 (P-ch MOSFET: IR)
 Tr2: CPH3409 (N-ch MOSFET: SANYO), IRLMS1902 (N-ch MOSFET: IR)
 Tr3: CPH3409 (N-ch MOSFET: SANYO), IRLMS1902 (N-ch MOSFET: IR)
 Note: V_{gs} Breakdown Voltage of CPH6315 and CPH3409 is 10V so please be careful with the power supply voltage.
 For the power supply voltage more than 8V, CPH3308 (P-ch MOSFET: SANYO) or CPH3408 (N-ch MOSFET: SANYO) which breakdown voltage is 20V are recommended.

L : 22 μH (CDRH127/LD, SUMIDA)
 SD : CMS02 (Schottky Barrier Diode, TOSHIBA)
 CL : 16V, 47 μF x 2 (Tantalum MCE Series, NICHICHEMI)
 C_{IN} : 16V, 47 μF (Tantalum MCE Series, NICHICHEMI)

EXTERNAL COMPONENTS

● COIL

PART NUMBER	MANUFACTURER	L VALUE (μH)	SERIAL RESISTANCE (Ω)	RATED CURRENT (A)	W x L (mm)	H (mm)
CDRH127/LD-220	SUMIDA	22	36.4m	4.7	12.3 x 12.3	8

● INPUT / OUTPUT CAPACITANCE

PART NUMBER	MANUFACTURER	VOLTAGE (V)	CAPACITANCE (μF)	W x L (mm)	H (mm)
16MCE476MD2	NICHICHEMI	16.0	47	4.6 x 5.8	3.2±0.2

● SCHOTTKY BARRIER DIODE

PART NUMBER	MANUFACTURER	REVERSE CURRENT	FORWARD CURRENT	V _{Fmax} (V)	I _{Rmax} (A)	W x L (mm)	H (mm)
CMS02	TOSHIBA	30	3	0.4 (I _F =3A)	0.5m (V _R =30V)	2.4 x 4.7	0.98±0.1

● TRANSISTOR (P-ch MOSFET)

PART NUMBER	MANUFACTURER	ABSOLUTE MAX. RATINGS			R _{ds(ON)} MAX.(mΩ)	C _{iss} TYP. (pF)	V _{Gs} (off) (V)	PKG.
		V _{DSS} (V)	V _{GSS} (V)	I _D (A)				
CPH6315	SANYO	- 20	±10	- 3	150 (V _{Gs} = -4.0V)	410 (V _{Gs} = -10V)	-1.4 (MAX.)	CPH6
CPH3308	SANYO	- 30	±20	- 4	140 (V _{Gs} = -4.0V)	560 (V _{Gs} = -10V)	-2.4 (MAX.)	CPH3
IRLMS6702	IR	- 20	±12	- 2.3	200 (V _{Gs} = -4.5V)	210 (V _{Gs} = -15V)	-0.7 (MAX.)	Micro6

● TRANSISTOR (N-ch MOSFET)

PART NUMBER	MANUFACTURER	V _{DSS} (V)	V _{GSS} (V)	I _D (A)	R _{ds(ON)} MAX.(mΩ)	C _{iss} TYP. (pF)	V _{Gs} (off) (V)	PKG.
CPH3409	SANYO	30	+10	5.0	42@V _{Gs} =4.0V	630@V _{Gs} =10V	1.3 (MAX.)	CPH3
CPH3408	SANYO	30	+20	5.0	68@V _{Gs} =4.0V	480@V _{Gs} =10V	2.4 (MAX.)	CPH3
IRLMS1902	IR	20	+12	3.2	100@V _{Gs} =4.5V	300@V _{Gs} =15V	0.7 (MIN.)	Micro6
IRLML2502	IR	20	+12	4.2	45@V _{Gs} =4.5V	740@V _{Gs} =15V	1.2 (MAX.)	Micro3

TEST CIRCUITS

Circuit ①

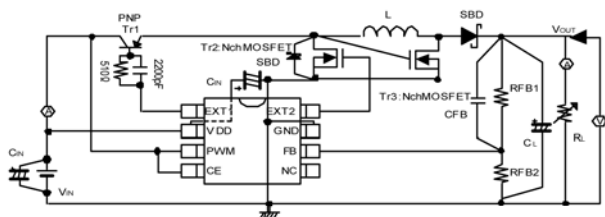

Circuit ②

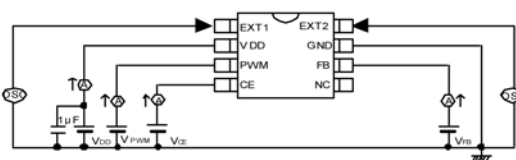

Circuit ③

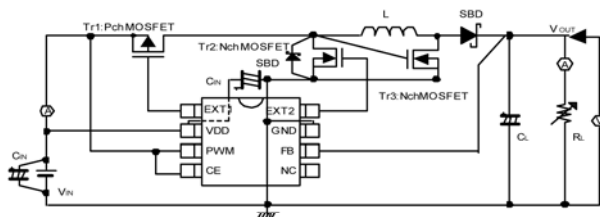

Circuit ④

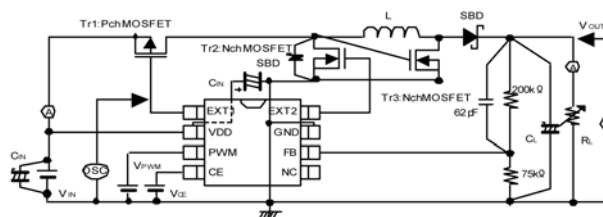

Circuit ⑤

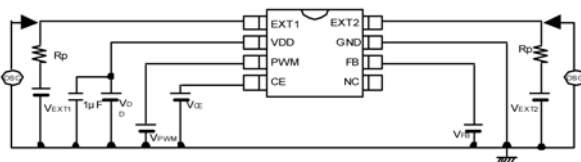

External Components:

Circuit ①

- L: 22 μ H (CDRH127/LD, SUMIDA)
- SD: CMS02 (Schottky Barrier Diode, TOSHIBA)
- CL: 16MCE476MD2 (Tantalum Type, NIHONCHEMICON)
- CIN: 16MCE476MD2 (Tantalum Type, NIHONCHEMICON)
- PNP Tr1: 2SA1213 (TOSHIBA)
- Tr2: CPH3409 (SANYO)
- Tr3: CPH3409 (SANYO)
- RFB: Please use by the conditions as below.
 $R_{FB1} + R_{FB2} \leq 1M\Omega$
 $R_{FB1} / R_{FB2} = (\text{Setting Output Voltage} / 0.9) - 1$
- CFB: $f_{ztb} = 1 / (2 \times \pi \times C_{FB} \times R_{FB1}) = 1kHz \sim 50kHz$ (12kHz usual)

Circuit ③

- L: 22 μ H (CDRH127/LD, SUMIDA)
- SD: CMS02 (Schottky Barrier Diode, TOSHIBA)
- CL: 16MCE476MD2 (Tantalum Type, NIHONCHEMICON)
- CIN: 16MCE476MD2 (Tantalum Type, NIHONCHEMICON)
- Tr1: CPH6315 (SANYO)
- Tr2: CPH3409 (SANYO)
- Tr3: CPH3409 (SANYO)

Circuit ④

- L: 22 μ H (CDRH127 / LD, SUMIDA)
- SD: CMS02 (Schottky Barrier Diode, TOSHIBA)
- CL: 16MCE476MD2 (Tantalum Type, NIHONCHEMICON)
- CIN: 16MCE476MD2 (Tantalum Type, NIHONCHEMICON)
- Tr1: CPH6315 (SANYO)
- Tr2: CPH3409 (SANYO)

NOTES ON USE

1. PWM/PFM Automatic Switching

If PWM/PFM automatic switching control is selected and the step-down ratio is high (e.g., from 10 V to 1.0 V), the control mode remains in PFM setting over the whole load range, since the duty ratio under continuous-duty condition is smaller than the PFM duty ratio of the XC9303 series. The output voltage's ripple voltage becomes substantially high under heavy load conditions, with the XC9303 series appearing to be producing an abnormal oscillation. If this operation becomes a concern, set pins PWM1 and PWM2 to High to set the control mode to PWM setting.

2. Ratings

Use the XC9303 series and peripheral components within the limits of their ratings.

3. Notes on How to Select Transistor

Synchronous rectification operation prepares fixed time when switching changes so that the high side P-ch MOSFET and the low side N-ch MOSFET do not oscillate simultaneously. Also it is designed to prevent the penetration current when the both MOSFET oscillate at the same time. However, some MOSFET may oscillate simultaneously and worsen efficiency. Please select MOSFET with high V_{th} with small input capacity on high side P-ch MOSFET and the low side N-ch MOSFET. (When using with large current, please note that there is a tendency for ON resistance to become large when the input capacity of MOSFET is small and V_{th} is high.)

<The check method of whether selected MOSFET is oscillating simultaneously>

In order to check that MOSFET is not oscillating simultaneously, please observe Lx terminal waveform of coil current at the time of the continuation mode. If the MOSFET parasitism diode waveform on Lx terminal waveform can be formed in the period EXT 1 is 'H' and EXT2 is 'L', it can be thought that MOSFETs are not oscillating simultaneously.

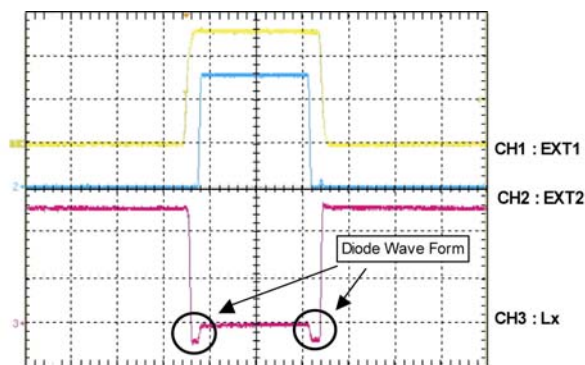

4. Instruction on Layout

- (1) The performance of the XC9303 DC/DC converter is greatly influenced by not only its own characteristics, but also by those of the external components it is used with. We recommend that you refer to the specifications of each component to be used and take sufficient care when selecting components.
- (2) Please mount each external component as close to the IC as possible. Wire external components as close to the IC as possible and use thick, short connecting wires to reduce wiring impedance. In particular, minimize the distance between the EXT2 pin and the Gate pin of the low side N-ch MOSFET. It may decrease efficiency.
- (3) Make sure that the GND wiring is as strong as possible as variations in ground potential caused by ground current at the time of switching may result in unstable operation of the IC. Specifically, strengthen the ground wiring in the proximity of the Vss pin.
- (4) For stable operation, please connect by-pass capacitor between the VDD and the GND.
- (5) Wiring between the GND pin of C_{IN} and the Sauce pin of the low side N-ch MOSFET connect to the GND pin of the IC. It may result in unstable operation of the IC.

TYPICAL APPLICATION CIRCUIT

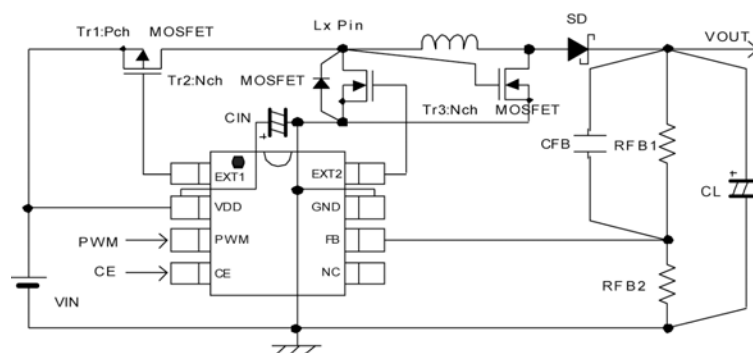

TYPICAL PERFORMANCE CHARACTERISTICS

(1) Output Voltage vs. Output Current

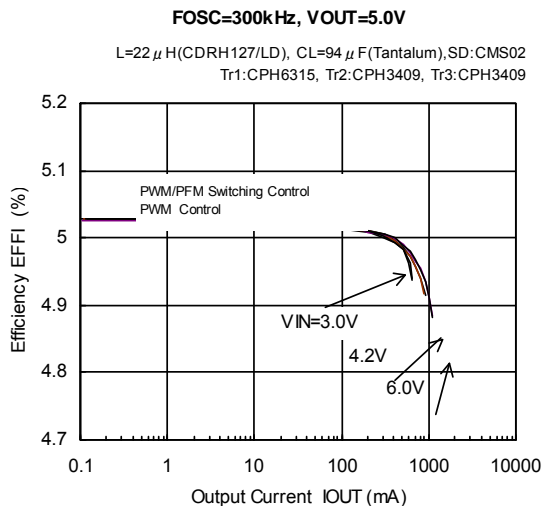
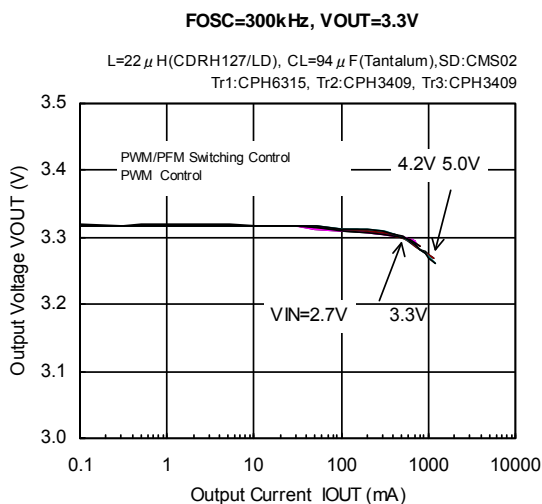

(2) Efficiency vs. Output Current

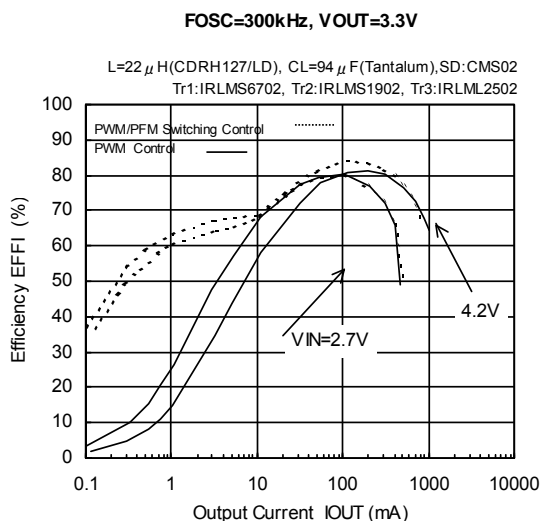
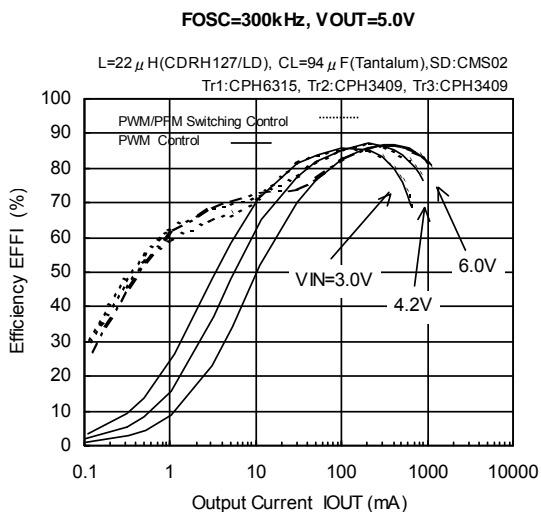
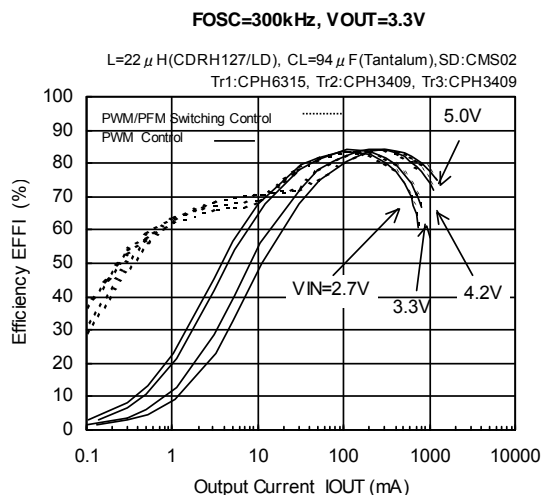
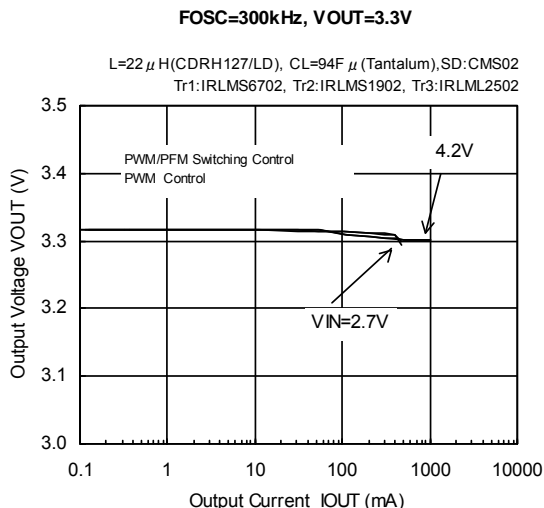

TYPICAL PERFORMANCE CHARACTERISTICS (Continued)

(3) Ripple Voltage vs. Output Current

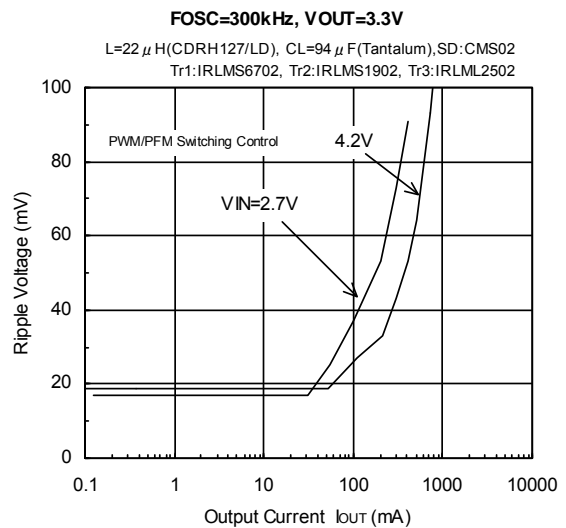
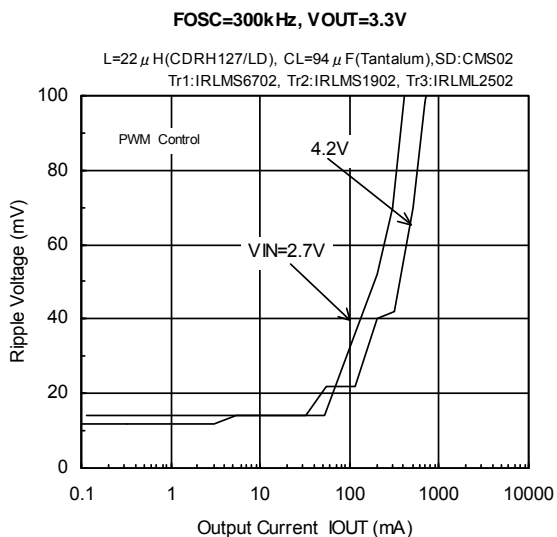
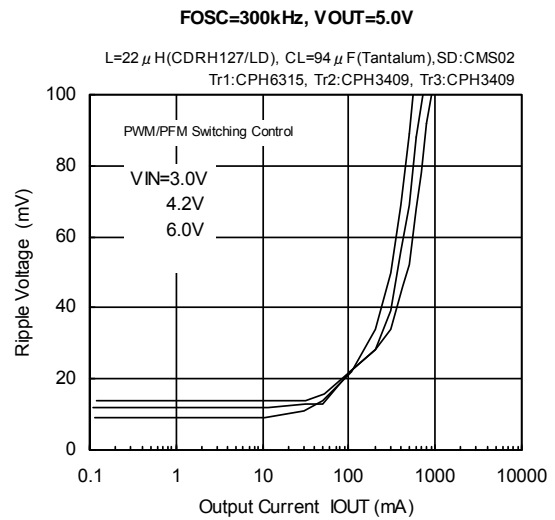
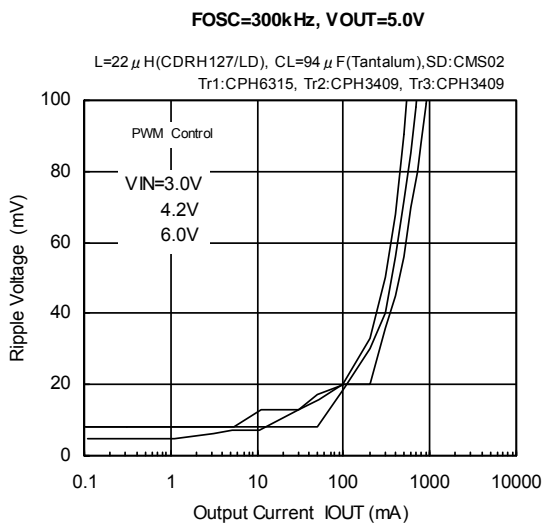
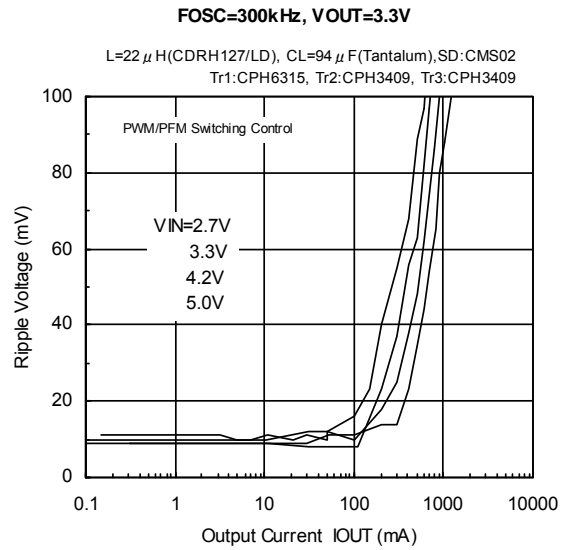
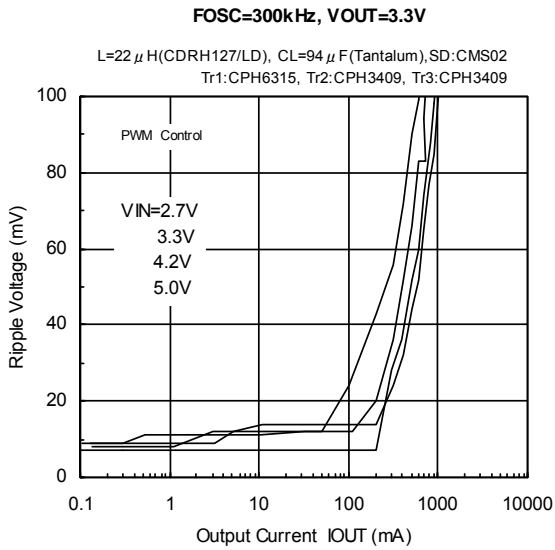

■ TYPICAL PERFORMANCE CHARACTERISTICS (Continued)

(4) Supply Current 1 vs. Supply Voltage

XC9303B093 (300kHz)

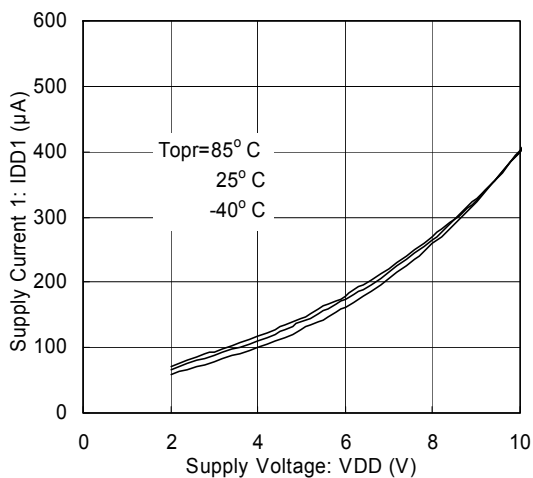

(5) Supply Current 2 vs. Supply Voltage

XC9303B093 (300kHz)

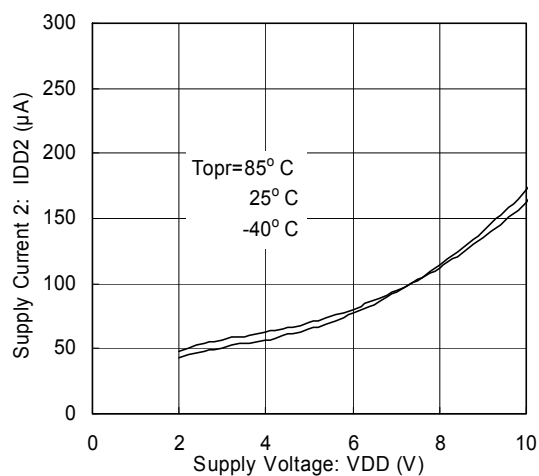

(6) Stand-by Current vs. Supply Voltage

XC9303B093 (300kHz)

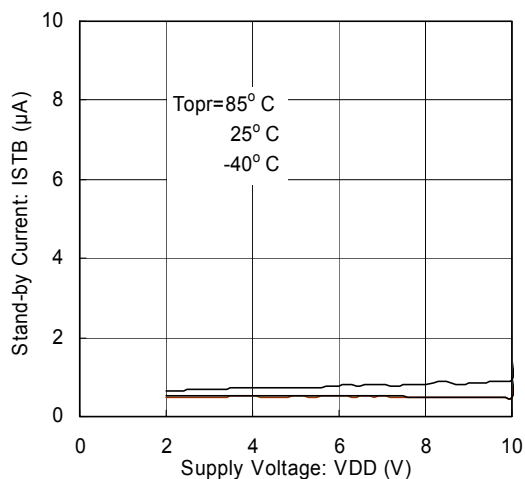

(7) Soft-start Time vs. Supply Voltage

XC9303B093 (300kHz)

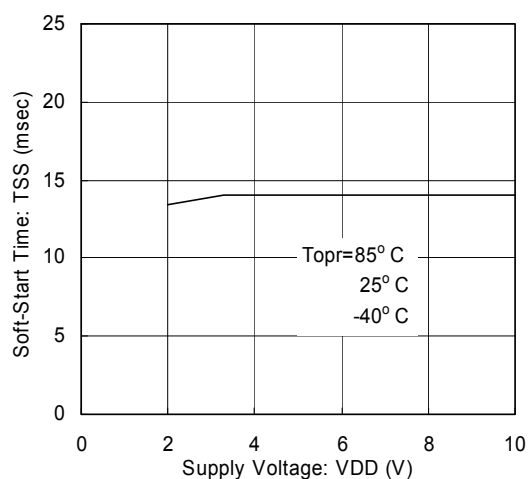

(8) CE 'H' 'L' Voltage vs. Supply Voltage

XC9303B093 (300kHz)

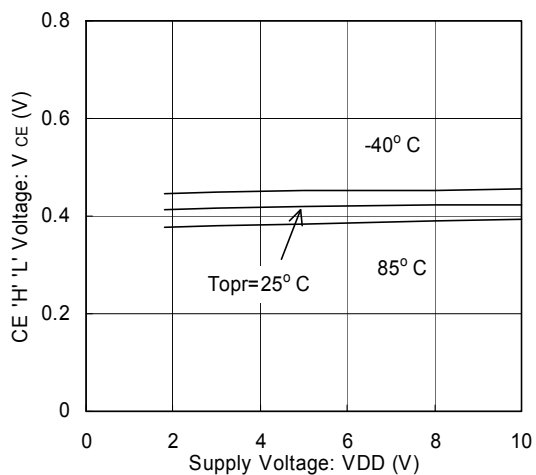

(9) PWM 'H' 'L' Voltage vs. Supply Voltage

XC9303B093 (300kHz)

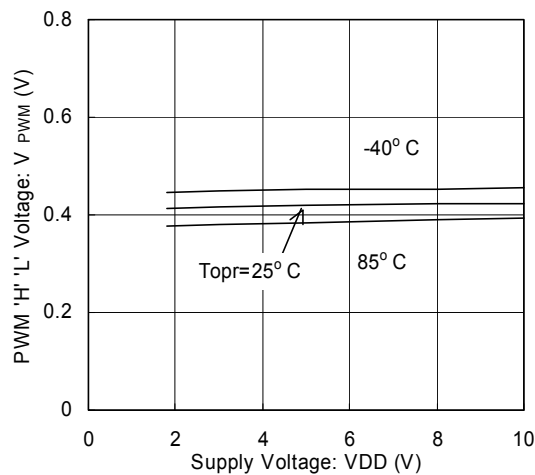

TYPICAL PERFORMANCE CHARACTERISTICS (Continued)

(10) Maximum Duty Ratio vs. Supply Voltage

XC9303B093 (300kHz)

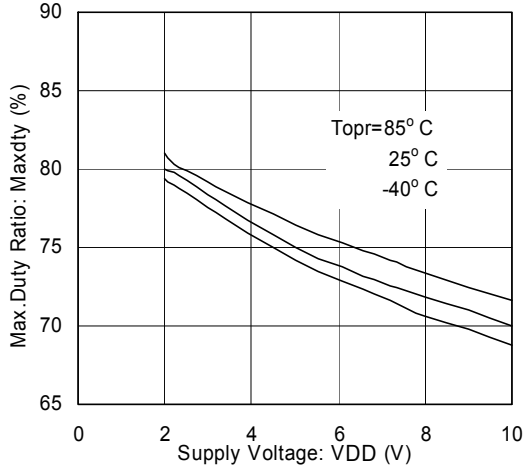

(11) Oscillation Frequency vs. Supply Voltage

XC9303B093 (300kHz)

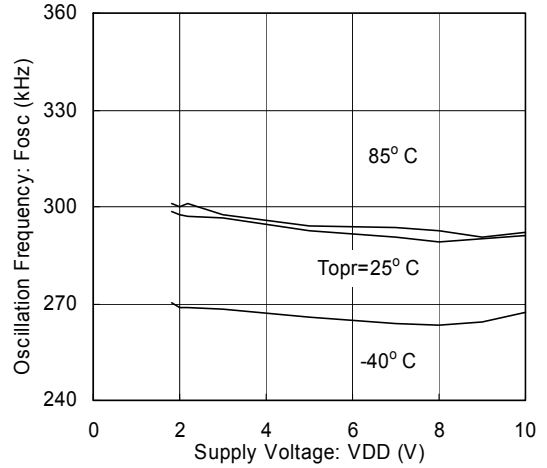

(12) EXT1 High ON Resistance vs. Supply Voltage

XC9303B093 (300kHz)
EXT1 'H' ON Resistance

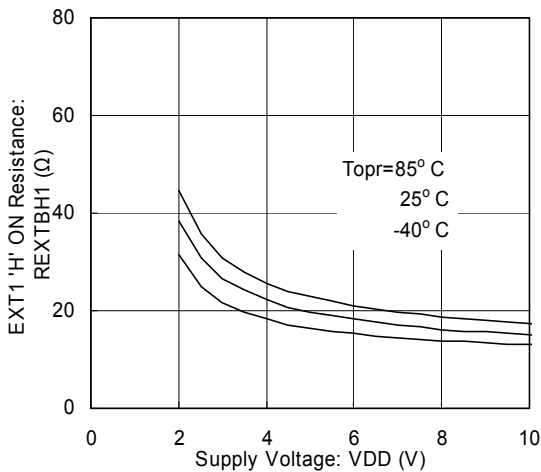

(13) EXT1 Low ON Resistance vs. Supply Voltage

XC9303B093 (300kHz)
EXT1 'L' ON Resistance

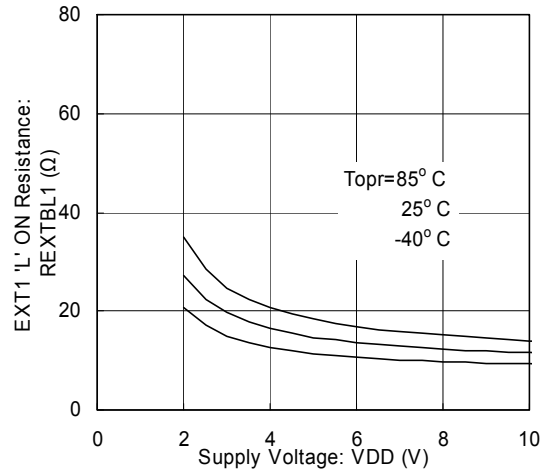

(14) EXT2 High ON Resistance vs. Supply Voltage

XC9303B093 (300kHz)
EXT2 'H' ON Resistance

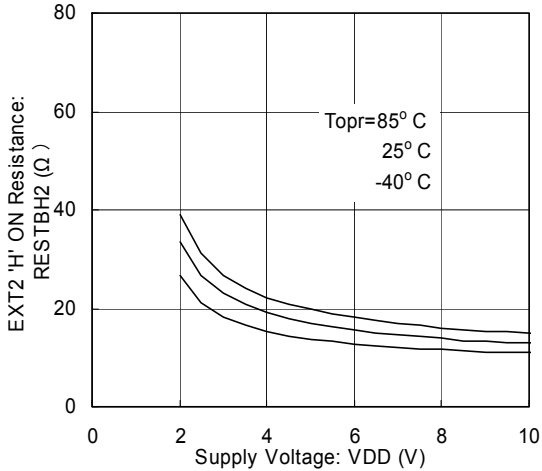

(15) EXT2 Low ON Resistance vs. Supply Voltage

XC9303B093 (300kHz)
EXT2 'L' ON Resistance

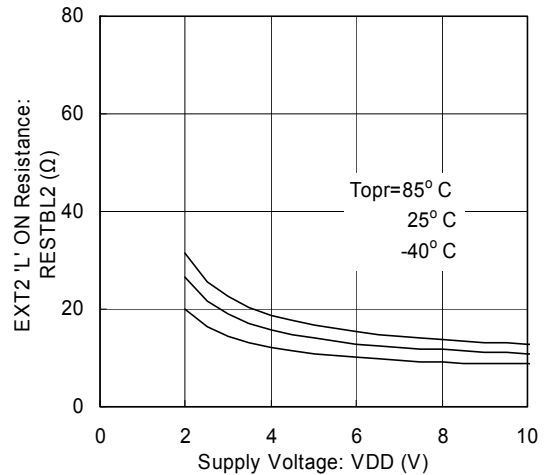

■ TYPICAL PERFORMANCE CHARACTERISTICS (Continued)

(16) Output Voltage vs. Ambient Temperature 1

XC9303B093 (300kHz)

L=22uH (CDRH127/LD), CL=94uF (Tantalum)
Tr1:CPH6315, Tr2:CPH3409,Tr3:CPH3409

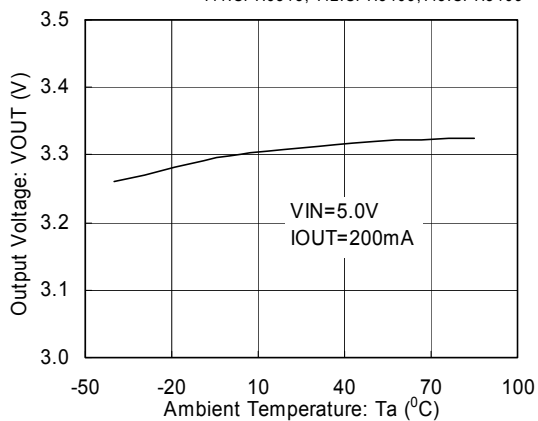

(17) Output Voltage vs. Ambient Temperature 2

XC9303B093 (300kHz)

L=22uH (CDRH127/LD), CL=94uF (Tantalum)
Tr1:CPH6315, Tr2:CPH3409,Tr3:CPH3409

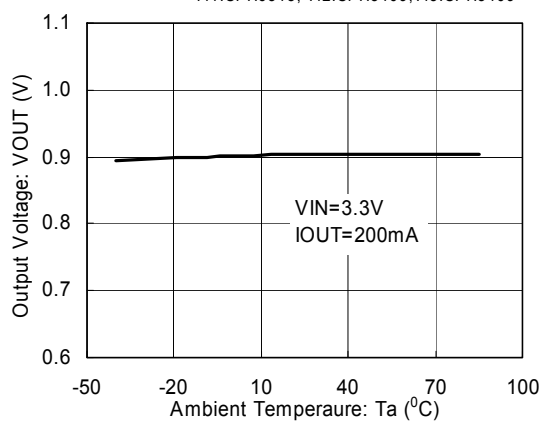

(18) PFM Duty Ratio vs. Supply Voltage

XC9303B093 (300kHz)

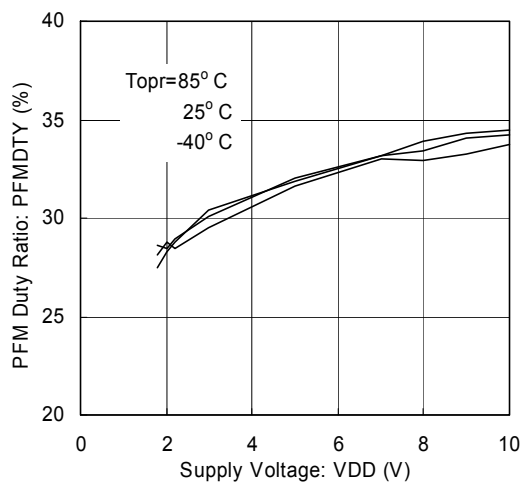

TYPICAL PERFORMANCE CHARACTERISTICS (Continued)

(19) Load Transient Response

<V_{OUT1, 2}=3.3V, V_{IN}=5.0V, I_{OUT1, 2}=100 μ A \leftrightarrow 100mA>

● Synchronous PWM Control

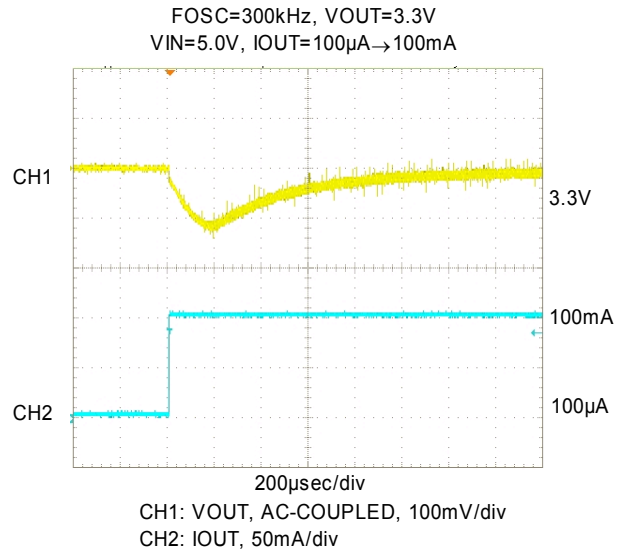
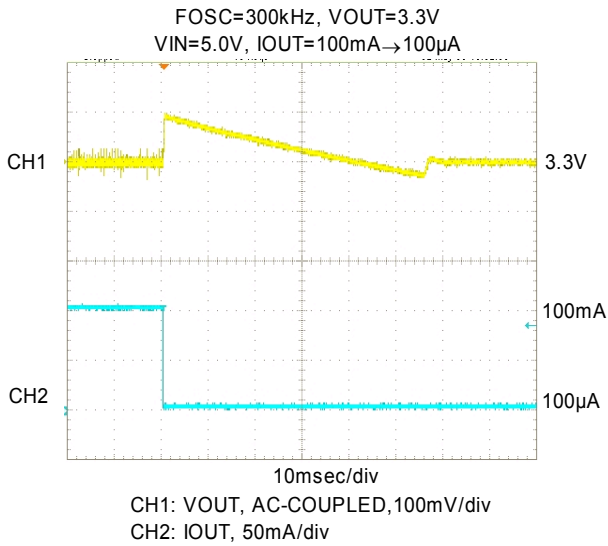

● Synchronous PWM/PFM Switching Control

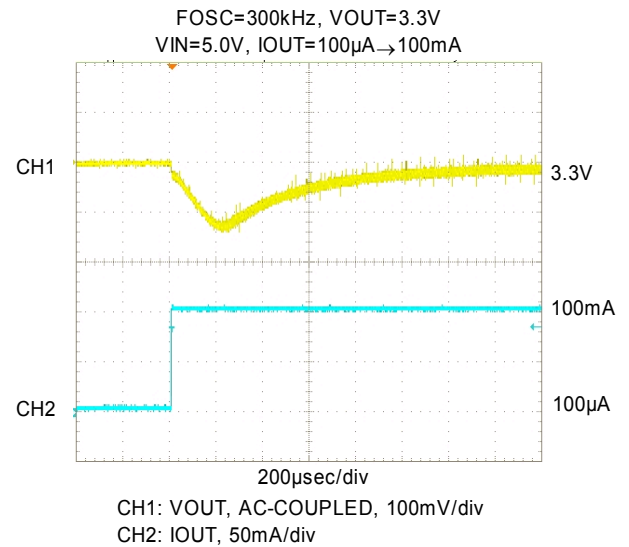
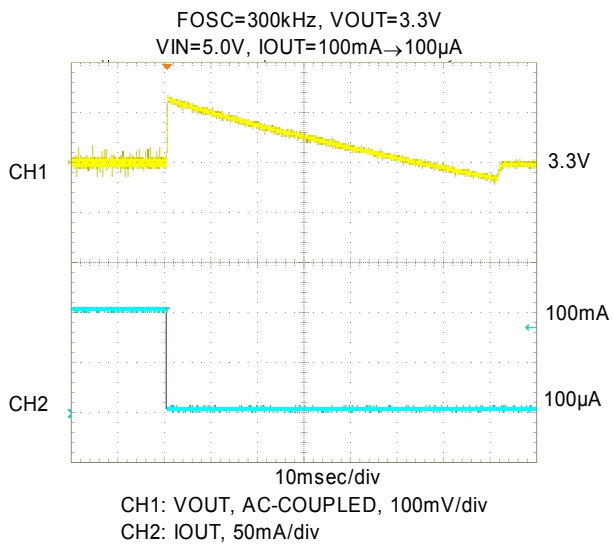

■ TYPICAL PERFORMANCE CHARACTERISTICS (Continued)

(19) Load Transient Response (Continued)

<V_{OUT1,2}=3.3V, V_{IN}=2.7V, I_{OUT1,2}=100μA↔300mA>

● Synchronous PWM Control

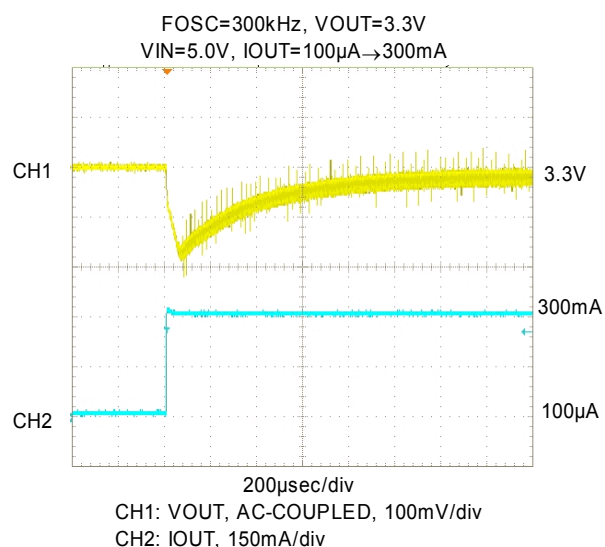
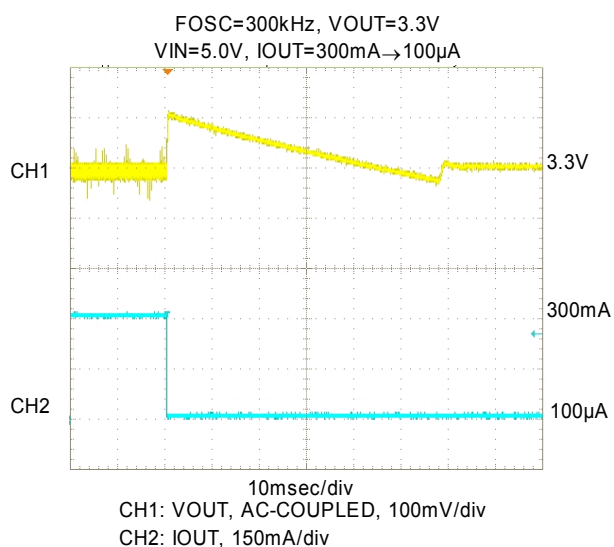

● Synchronous PWM/PFM Switching Control

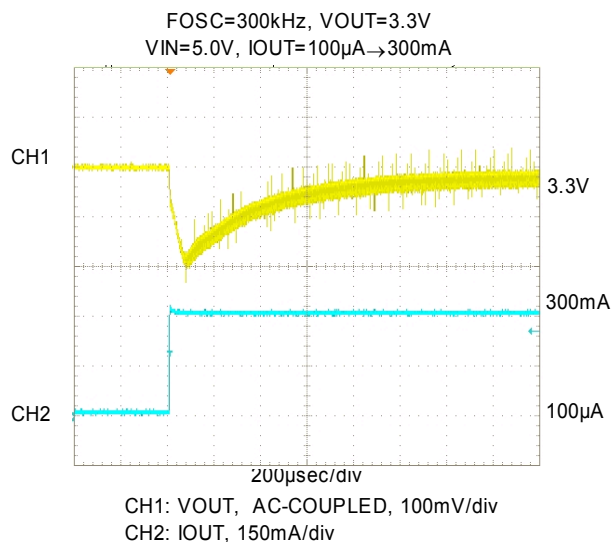
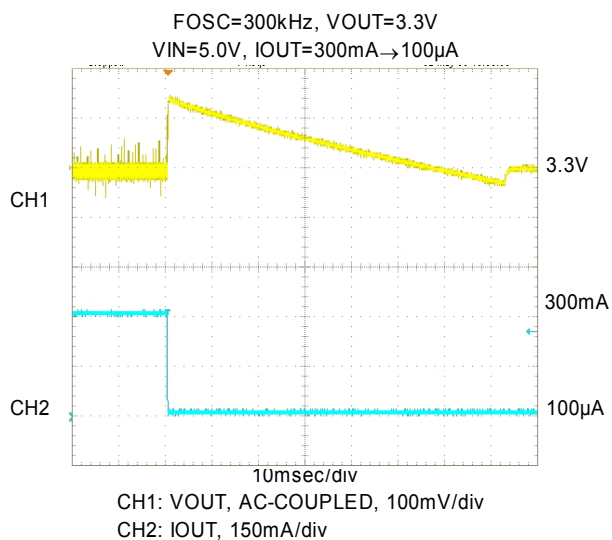

TYPICAL PERFORMANCE CHARACTERISTICS (Continued)

(19) Load Transient Response (Continued)

<V_{OUT1,2}=3.3V, V_{IN}=2.7V, I_{OUT1,2}=100μA↔300mA>

● Synchronous PWM Control

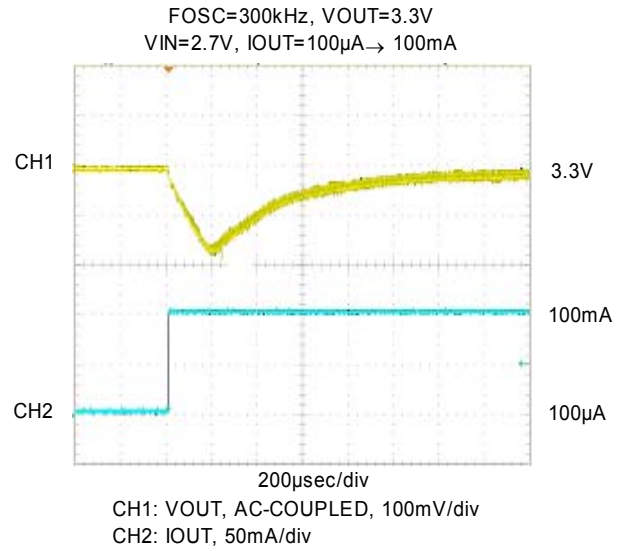
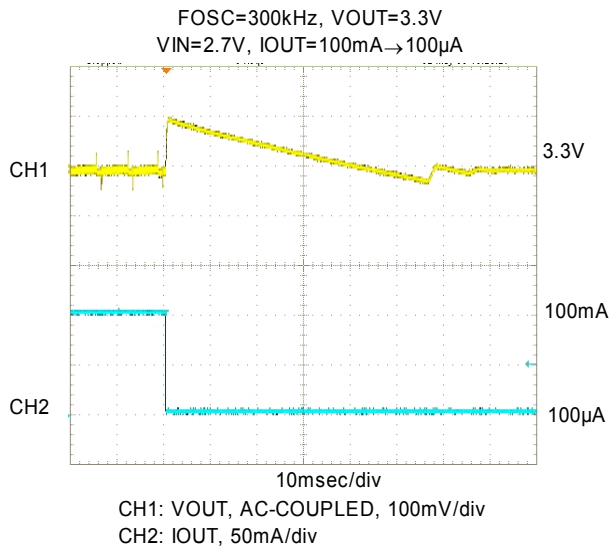

● Synchronous PWM/PFM Switching Control

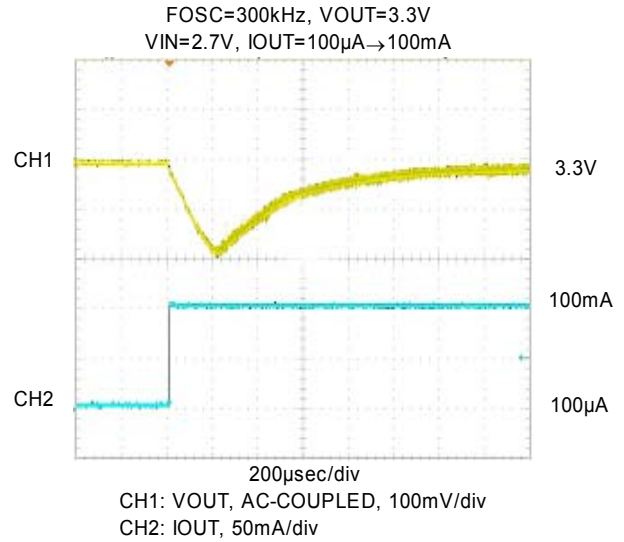
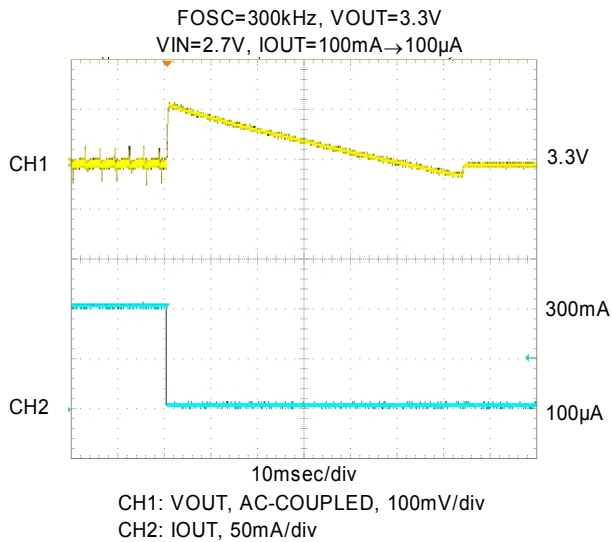

■ TYPICAL PERFORMANCE CHARACTERISTICS (Continued)

(19) Load Transient Response (Continued)

<V_{OUT1, 2}=3.3V, V_{IN}=2.7V, I_{OUT1, 2}=100 μA↔300mA>

● Synchronous PWM Control

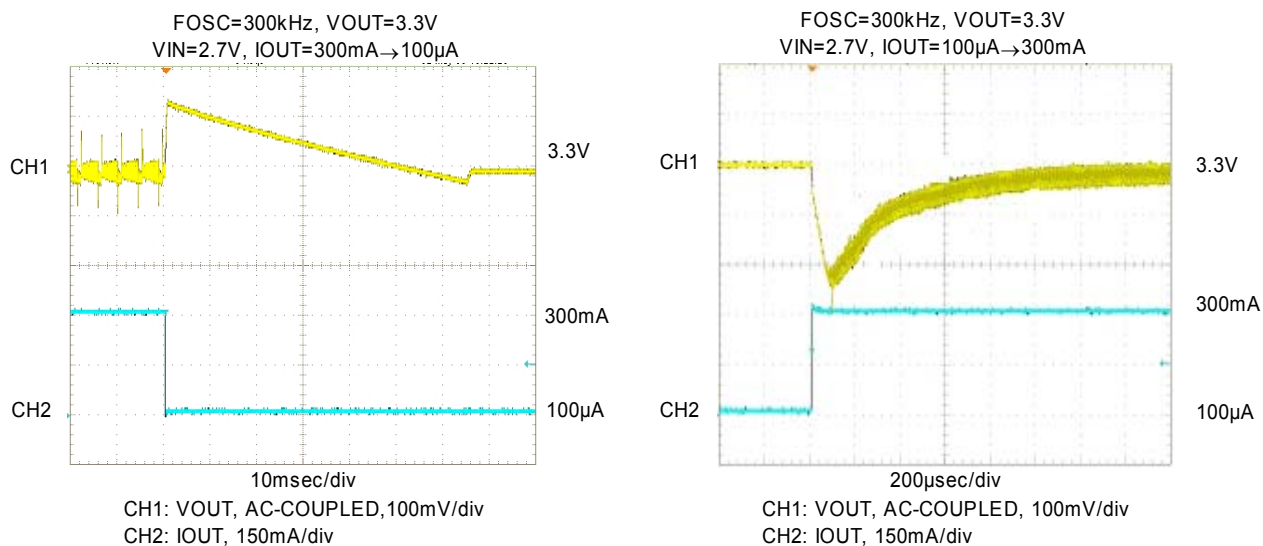

● Synchronous PWM/PFM Switching Control

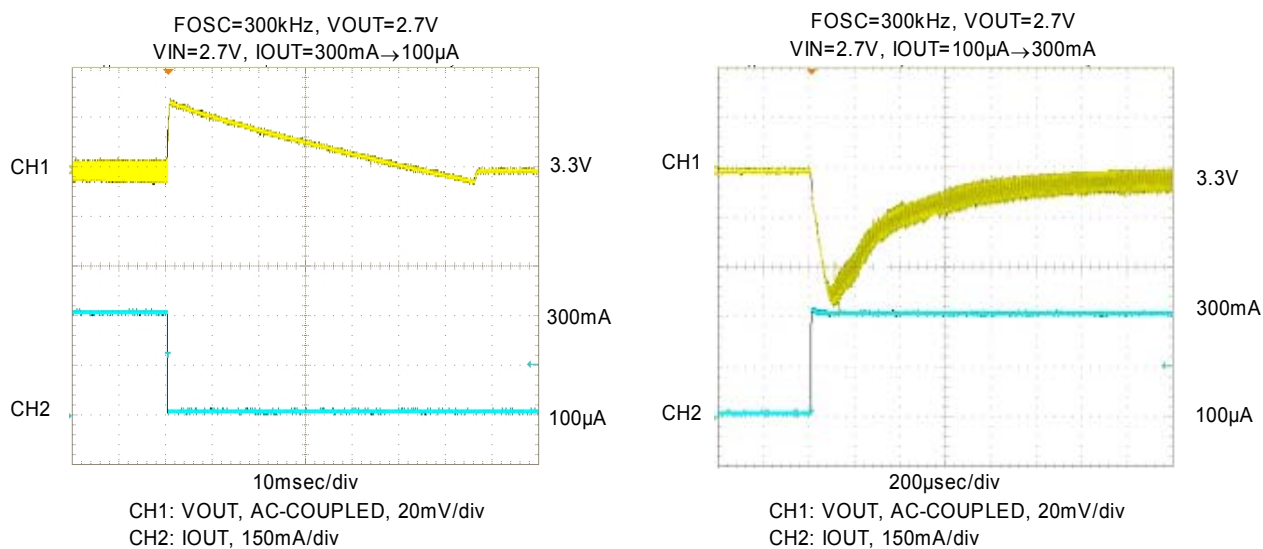

TYPICAL PERFORMANCE CHARACTERISTICS (Continued)

(19) Load Transient Response (Continued)

<PWM Control ⇔ PWM/PFM Switching Control>

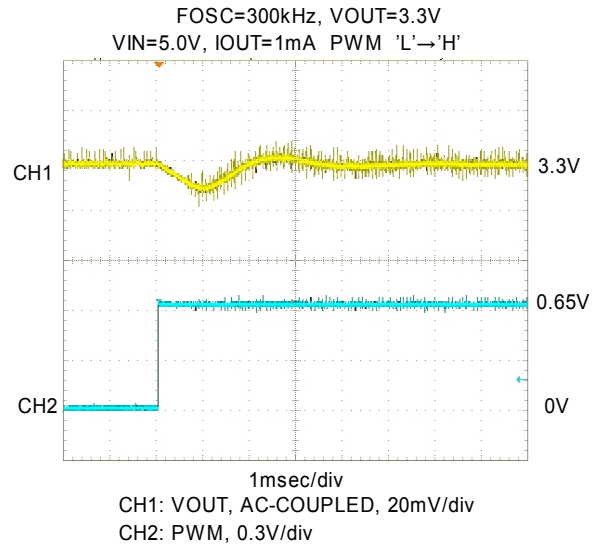
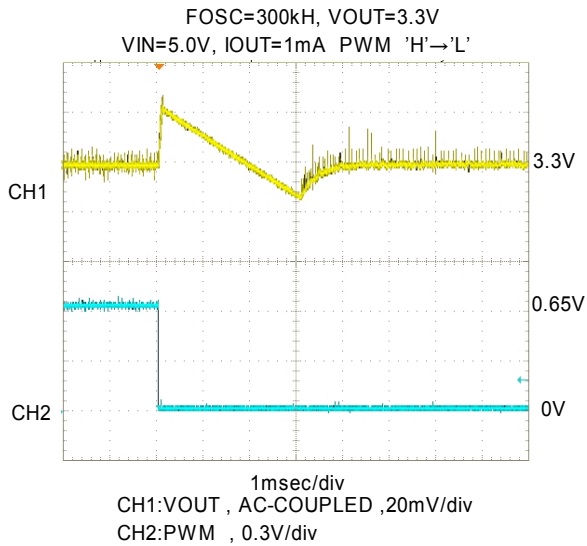

<Soft-Start Wave Form>

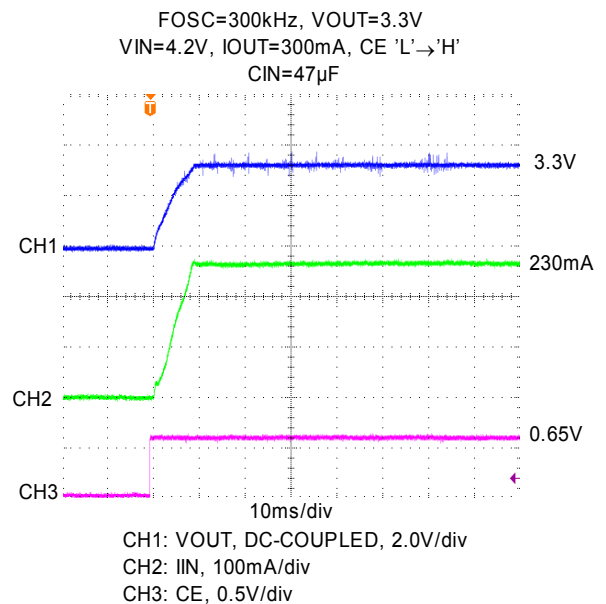
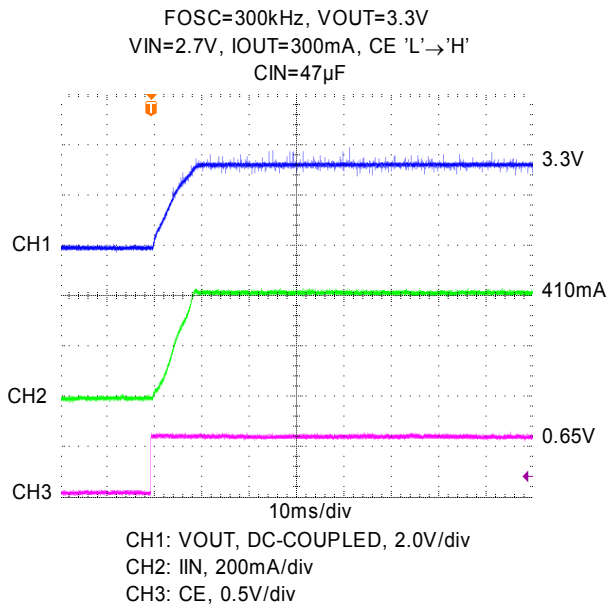

■ PACKAGE INFORMATION

● MSOP-8A

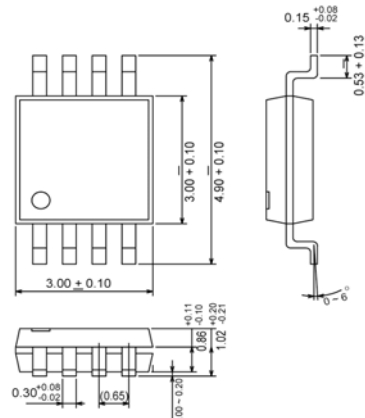

■ MARKING RULE

● MSOP-8A

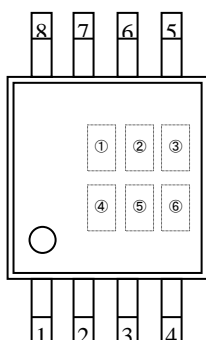

MSOP-8A
(TOP VIEW)

① represents product series

MARK	PRODUCT SERIES
6	XC9303B093Kx

② represents type of DC/DC Controller

MARK	PRODUCT SERIES
B	XC9303B093Kx

③,④ represents out FB voltage

MARK		VOLTAGE (V)	PRODUCT SERIES
③	④		
0	9	0.9	XC9303B093Kx

⑤ represents oscillation frequency

MARK	OSCILLATION FREQUENCY (kHz)	PRODUCT SERIES
3	300	XC9303B093Kx

⑥ represents production lot number

0 to 9,A to Z repeated (G, I, J, O, Q, W excluded)

Note: No character inversion used

1. The products and product specifications contained herein are subject to change without notice to improve performance characteristics. Consult us, or our representatives before use, to confirm that the information in this datasheet is up to date.
2. We assume no responsibility for any infringement of patents, patent rights, or other rights arising from the use of any information and circuitry in this datasheet.
3. Please ensure suitable shipping controls (including fail-safe designs and aging protection) are in force for equipment employing products listed in this datasheet.
4. The products in this datasheet are not developed, designed, or approved for use with such equipment whose failure or malfunction can be reasonably expected to directly endanger the life of, or cause significant injury to, the user.
(e.g. Atomic energy; aerospace; transport; combustion and associated safety equipment thereof.)
5. Please use the products listed in this datasheet within the specified ranges.
Should you wish to use the products under conditions exceeding the specifications, please consult us or our representatives.
6. We assume no responsibility for damage or loss due to abnormal use.
7. All rights reserved. No part of this datasheet may be copied or reproduced without the prior permission of TOREX SEMICONDUCTOR LTD.

TOREX SEMICONDUCTOR LTD.