

# Portable 10-Channel Data Recorder

## DAS220-BAT Series



The DAS220-BAT series measures and records parameters commonly found in process applications including voltage, temperature, current, resistance, frequency, and pulse. It includes 10 universal integrated analog channels with convenient screw input terminals. This recorder was developed by B&K Precision's subsidiary Sefram in France, which specializes in the design and manufacture of data acquisition instruments, field strength meters, and other test and measurement instruments.

Measurement results are viewed graphically and numerically on a 10-inch color touchscreen and saved to internal memory or external USB memory. Icon-driven menus make the instrument easy to navigate. The free DasLab Windows PC software allows users to remotely control and configure the recorder, transfer logging results and configuration files, and view live data in graphical or numerical format on the PC.

The data recorder features 32 GB of solid-state memory for data logging over extended periods. The internal battery provides back-up in the event of power loss (-BAT).

### Applications

- Temperature logging with thermocouples and platinum resistance temperature sensors
- Voltage measurements down to  $\pm 0.5$  mV range
- 4-20 mA current loop measurements
- Frequency, pulse totalization and pulse rotation measurements, which can be expressed in RPM (rotations per minute)



10 universal analog channels are integrated for portability

### Features and benefits:

- Wide 10-inch touchscreen TFT display
- 10 built-in universal analog inputs
- Extended battery life of up to 15 hours (-BAT)
- Versatile temperature measurements supporting thermocouples and Pt100 / Pt1000 temperature sensors
- Measure voltage to  $\pm 100$  V, resistance to 10 k $\Omega$  and current (with optional shunt input-terminal block)
- 16-bit vertical resolution
- Recording interval (sampling rate) up to 1 ms
- 12 logic input/output channels
- 4 timing logic input channels for pulse count, frequency and PWM measurements
- 4 alarm outputs
- WiFi monitoring and control (standard USB WiFi dongle required)
- 32 GB internal solid state memory
- 2 USB Host ports and 1 LAN interface
- Free DasLab operating software
- Virtual Networking Computing (VNC) capability for replicating the instrument's front panel interface on a PC

## Front panel

### 10" Touchscreen

TFT display with 10 inch touchscreen to facilitate signal viewing and analysis

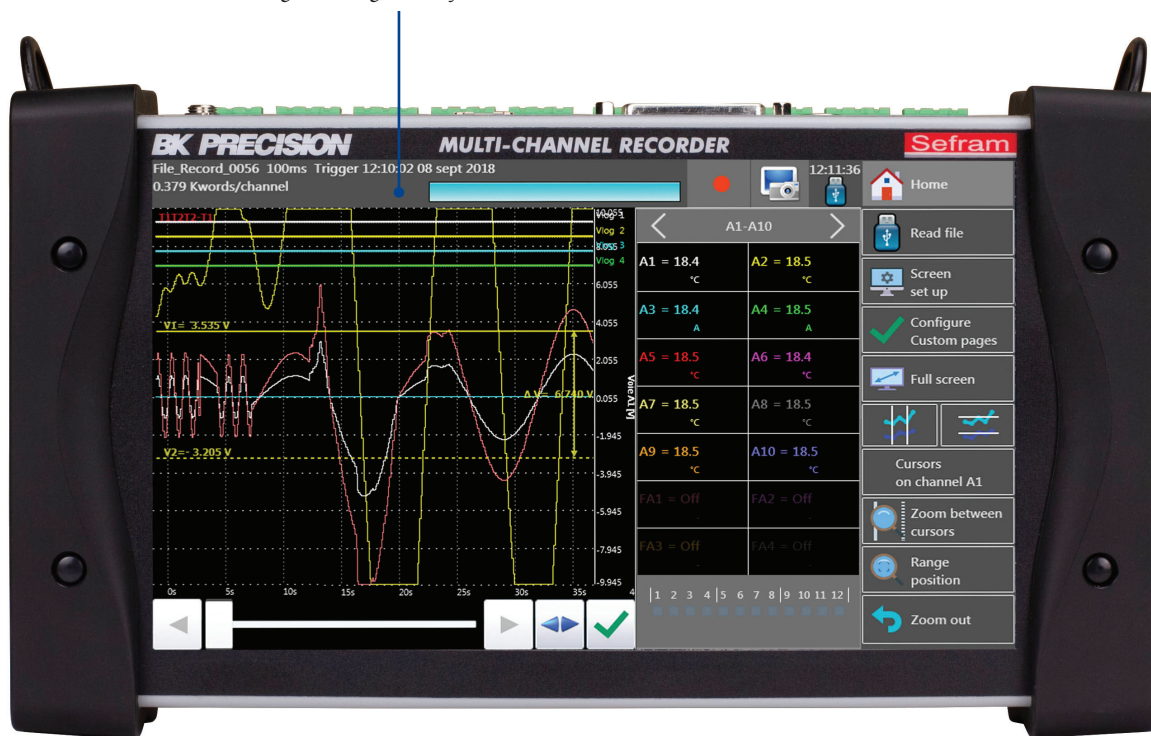

## Top input and connection panel

### Analog channels

Multiplexed analog channels for logging voltage, temperature, and current.

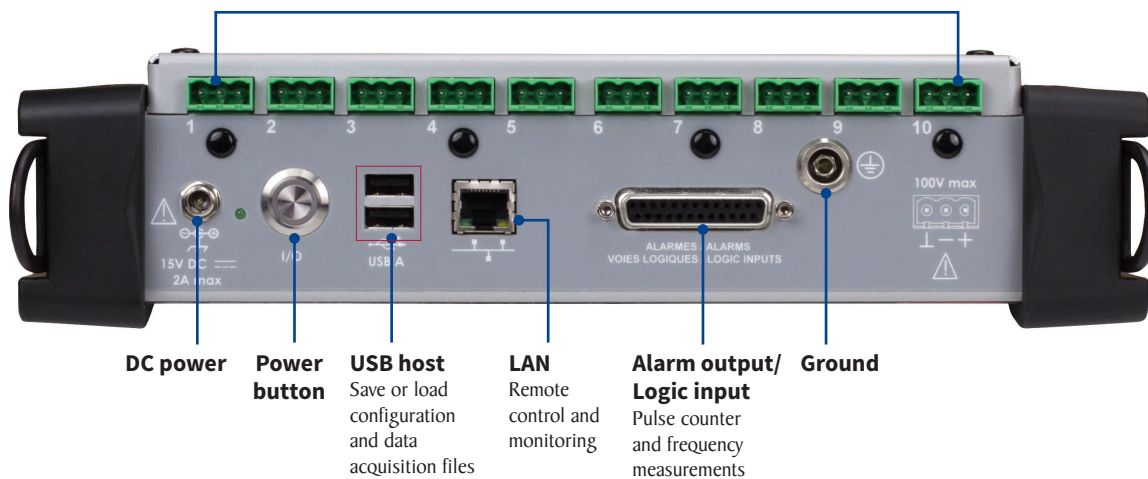

## Flexible operation

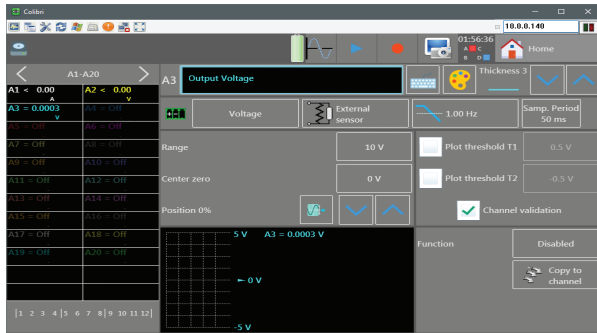

Large display with icon-driven menus for easy setup and operation.

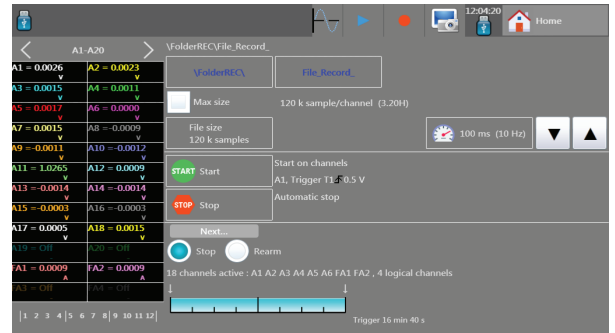

Comprehensive triggering capabilities: Configure triggers on analog and logic channels. Select from multiple combinations of thresholds, channels and conditions.



Numerical display of measured values

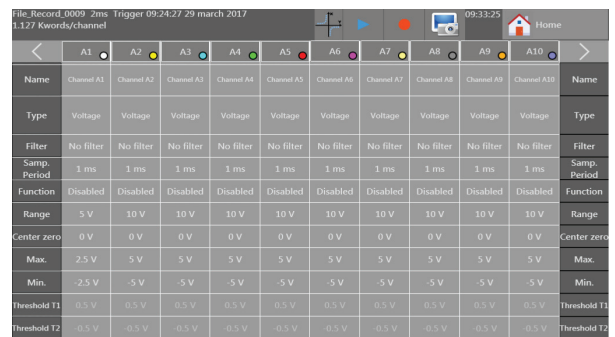

Channel setup displays all parameters on a single screen

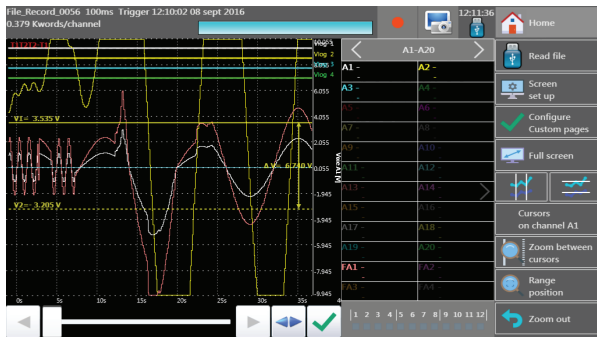

Measurement display with zoom and cursors

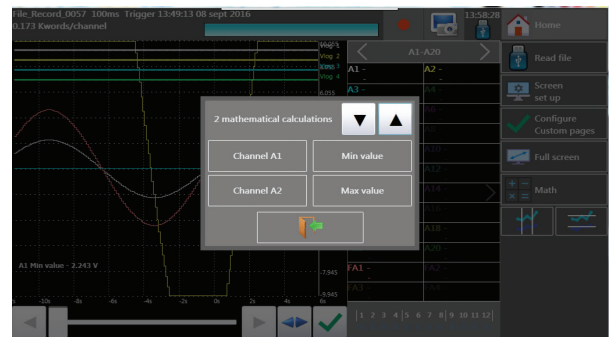

Math calculations between channels

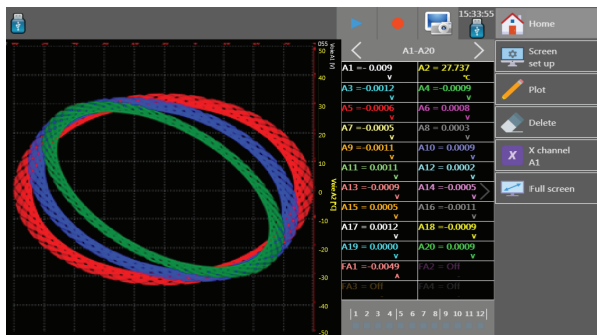

XY mode for plotting one varying voltage versus another

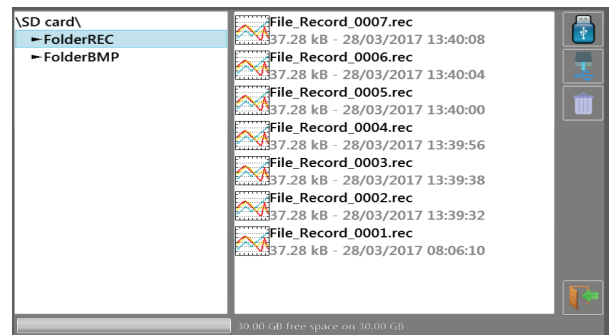

Internal file management

## The tools you need

### DasLab software

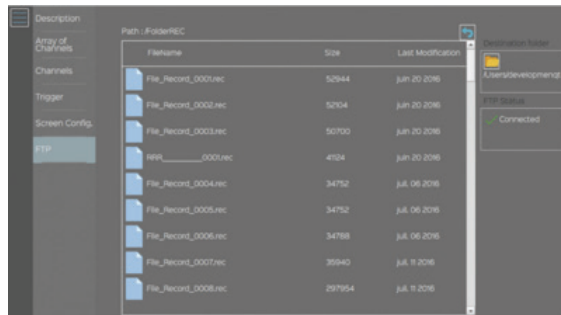

DasLab file management

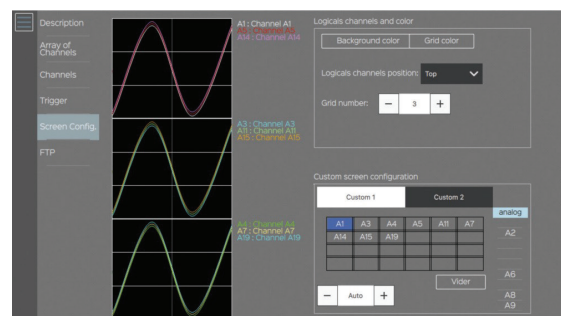

DasLab remote setup

DasLab is a license-free Windows compatible software that can be downloaded from [www.bkprecision.com](http://www.bkprecision.com). The software controls the recorder through the LAN or WiFi interface and provides the following features:

- Channel and trigger configuration
- Display live measurement results in graphical or numerical format
- File management, file upload and download of data recordings, screen captures and configuration files

### Virtual Network Computing (VNC) capability

The recorder's built-in VNC capability, based on the Remote Frame Buffer protocol (RFB), provides a graphical desktop sharing system to remotely control the instrument from another computer. VNC is platform independent and provides a means to control all functions of the instrument through a graphical interface replicating the instrument's front panel using a mouse and keyboard.

### Optional accessories



The 50  $\Omega$  shunt can be used on any channel of the recorder to accurately measure, display, and record the output from 4 to 20 mA current loop sensors.



Rugged carrying case



Analog input connectors 10 pack



Logic channels patch cord

## Specifications

Note: All specifications apply to the unit after a temperature stabilization time of 30 minutes over an ambient temperature range of 23 °C ± 5 °C.

Analog Channels		
Analog Input Channels	10 integrated channels	
<b>DC Voltage</b>		
Ranges	± (0.5, 1, 2.5, 5, 10, 25, 50, 100) mV ± (0.5, 1, 2.5, 5, 10, 25, 50, 100) V	
Maximum input Voltage	100 V DC	
Accuracy	0.1% of the full scale ±10 µV	
<b>Temperature with Thermocouples</b>		
Sensors Range by Type (Cold junction compensation: ±0.5 °C)	J	-210 °C to 1200 °C
	K	-250 °C to 1370 °C
	T	-200 °C to 400 °C
	S	-50 °C to 1760 °C
	B	200 °C to 1820 °C
	E	-250 °C to 1000 °C
	N	-250 °C to 1300 °C
	C	0 °C to 2320 °C
L	-200 °C to 900 °C	
<b>Temperature with Pt100 and Pt1000</b>		
Current	1 mA (Pt100), 100 µA (Pt1000)	
Range	-200 °C to 850 °C	
Measurements	2 and 3 wires	
Accuracy (at 20 °C)	0.3 °C ±0.1% of reading	
Compensated Resistance	2 wires	30 Ω max.
	3 wires	50 Ω max.
<b>Resistance</b>		
Ranges	1 kΩ and 10 kΩ	
Accuracy	1 Ω (range 1 kΩ) and 10 Ω (range 10 kΩ)	
Logic Channels		
<b>Logic Input/Output</b>		
Number of Channels	12	
Maximum Permitted Voltage	24 V Cat I	
Input Impedance	4.7 kΩ	
Sampling Rate	1 ms max.	
<b>Timing Input</b>		
Number of Channels	4 (K1 to K4)	
Maximum Permitted Voltage	24 V Cat I	
Input impedance	4.7 kΩ	
Sampling Rate	1 ms max.	
Pulse Counter	0 to 10 Million, accuracy 0.1%	
Frequency Measurement	1 Hz to 10 kHz, accuracy 0.1%	
PWM Measurement	100 Hz to 2 kHz, accuracy 0.1%	
<b>Alarm Output</b>		
Number of Channels	4 Alarms (A, B, C, D)	
Output Level	0 to 5 V	

Acquisition System		
Resolution	16 bit	
Acquisition System	Scan, one sample per channel	
Sampling Interval	V >50 mV	1 ms to 20 min
	V ≤50 mV, thermocouples and Pt100 / Pt1000	2 ms to 20 min
Trigger	Date, delay, threshold, combination of thresholds (and/or), word on logic channels (and, or, slope, level)	
Pre-trigger	Variable from 0 to 100k samples	
General		
Internal Flash Drive Size	32 GB	
Maximum File Size	2 GB	
Operating Temperature	0 °C to 40 °C, 80% RH (no condensation)	
Storage Temperature	-20 °C to 60 °C	
Display	10" TFT touchscreen LCD, backlit, 1024 x 600 dots	
Power Supply	15 V / 4 A max with main adapter (100 / 240 VAC)	
Interfaces	2 x USB host, LAN (10/100 base-T with RJ45 socket)	
Battery (-BAT)	Non removable, Lithium-ion	
Typical Battery Life (-BAT)	15 hours with standby mode, 10 hours without stand-by mode	
Safety	Cat I 100 V, according to IEC61010-1	
Weight	DAS220 / 3.3 lbs (1.5 kg)	
	DAS220-BAT / 4.5 lbs (2 kg)	
Dimensions (W x H x D)	2.6" x 11.7" x 6.9" (66 x 298 x 176 mm)	
Warranty	Two Years	
Supplied Accessories	Main adapter 100 / 240 V, 25 pin male connector <sup>(1)</sup> and backshell, 10 input connectors, shoulder strap, stylus, soft wipe, screwdriver, calibration certificate and test report	
Order Information for Optional Accessories		
902401050	Analog input terminal blocks 20 pack	
902408000	Rugged carrying case	
902407000	Logic channels patch cord	
902406500	4 to 20 mA / 50 Ω shunt	
902409000	19" rack-mount kit	

(1) User configurable with solder cups.

## About B&K Precision

For more than 60 years, B&K Precision has provided reliable and value-priced test and measurement instruments worldwide.

Our headquarters in Yorba Linda, California houses our administrative and executive functions as well as sales and marketing, design, service, and repair. Our European customers are most familiar with B&K through our French subsidiary, Sefram. Engineers in Asia know us through our B&K Precision Taiwan operation. Our B&K Brasil office supports our expanding customer base in Brazil and other South American countries. The independent service center in Singapore services customers in Singapore, Malaysia, Vietnam, and Indonesia.

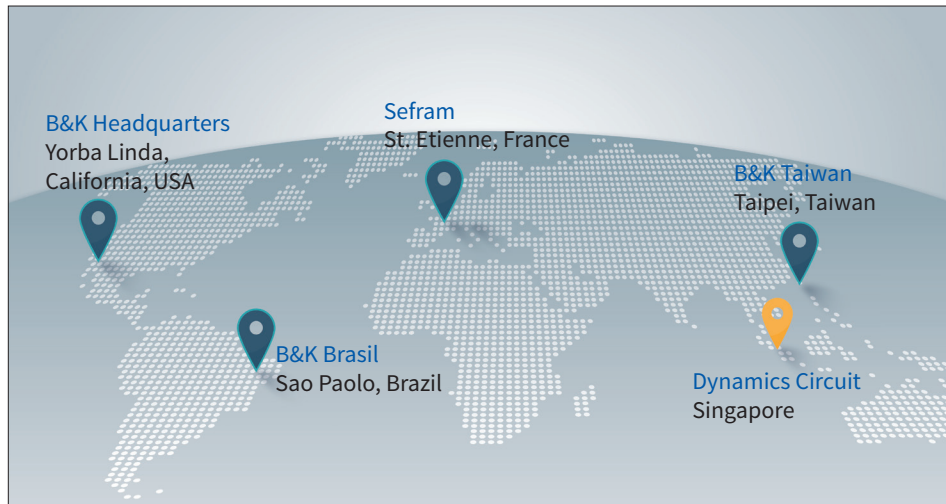

● B&K Precision group member ● Independent service center ● Service center location

## Quality Management System

B&K Precision Corporation is an ISO9001 registered company employing traceable quality management practices for all processes including product development, service, and calibration.

ISO9001:2015

Certification body NSF-ISR  
Certificate number 6Z241-ISR



## Video Library

View product overviews, demonstrations, and application videos in English, Spanish and Portuguese.

<http://www.youtube.com/user/BKPrecisionVideos>

## Product Applications

Browse all of our supported product and mobile applications.

<http://bkprecision.com/product-applications>