

Data Sheet

Description/Applications

These ultra-miniature products represent the blending of Broadcom’s proven semiconductor and the latest in leadless packaging. This series of Schottky diodes is the most consistent and best all-round device available, and finds applications in mixing, detecting, switching, sampling, clamping, and wave shaping at frequencies up to 6 GHz. The MiniPak package offers reduced parasitics when compared to conventional leaded diodes, and lower thermal resistance.

The HMPS-282x family of diodes offers the best all-around choice for most applications, featuring low series resistance, low forward voltage at all current levels and good RF characteristics.

Note that Broadcom’s manufacturing techniques assure that dice found in pairs and quads are taken from adjacent sites on the wafer, assuring the highest degree of match.

Minipak 1412 is a ceramic-based package, while Minipak QFN is a leadframe-based package.

Package Lead Code Identification (Top View)

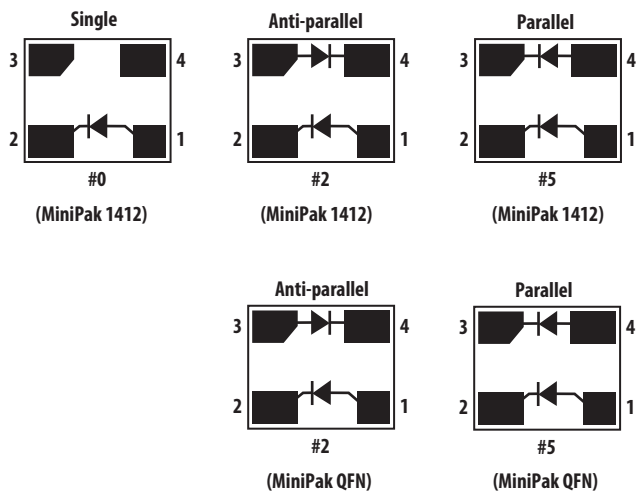

Features

- Surface-mount MiniPak package
- Better thermal conductivity for higher power dissipation
- Single and dual versions
- Matched diodes for consistent performance
- Low turn-on voltage (as low as 0.34V at 1 mA)
- Low FIT (Failure in Time) rate¹
- Six-sigma quality level

Pin Connections and Package Marking

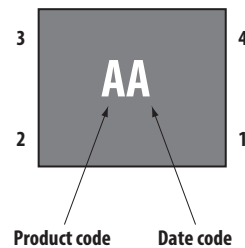

NOTE

1. Package marking provides orientation and identification.
2. See Electrical Specifications for appropriate package marking.

CAUTION

Handling precautions should be taken to avoid static discharge.

1. For more information, refer to the *Surface Mount Schottky Reliability Data Sheet*.

HMPS-282x Series Absolute Maximum Ratings (See Note)

$T_C = 25^\circ\text{C}$.

Symbol	Parameter	Units	MiniPak 1412/MiniPak QFN
I_f	Forward Current (1 μs pulse)	A	1
P_{IV}	Peak Inverse Voltage	V	15
T_j	Junction Temperature	$^\circ\text{C}$	150
T_{stg}	Storage Temperature	$^\circ\text{C}$	-65 to +150
θ_{jc}	Thermal Resistance ^a	$^\circ\text{C}/\text{W}$	150

a. $T_C = +25^\circ\text{C}$, where TC is defined to be the temperature at the package pins where contact is made to the circuit board.

NOTE Operation in excess of any one of these conditions may result in permanent damage to the device.

MiniPak 1412 Electrical Specifications

$T_C = +25^\circ\text{C}$, Single Diode (see note).

Part Number HMPS-	Package Marking Code	Lead Code	Configur- ation	Minimum Breakdown Voltage V_{BR} (V)	Maximum Forward Voltage V_F (mV)	Maximum Forward Voltage V_F (V) @ I_F (mA)		Maximum Reverse Leakage I_R (nA) @ V_R (V)		Maximum Capacitance C_T (pF)	Typical Dynamic Resistance R_D (Ω) ^a
						0.5	10	100	1		
2820	L	0	Single	15	340	0.5	10	100	1	1.0	12
Test Conditions				$I_R = 100 \mu\text{A}$	$I_F = 1 \text{ mA}^b$					$V_F = 0\text{V}$, $f = 1 \text{ MHz}^c$	$I_F = 5 \text{ mA}$

a. $R_D = R^S + 5.2\Omega$ at 25°C and $I_f = 5 \text{ mA}$.

b. ΔV_F for diodes in pairs is 15 mV maximum at 1 mA.

c. ΔC_{T0} for diodes in pairs is 0.2 pF maximum.

NOTE Effective carrier lifetime (τ) for all these diodes is 100 ps maximum measured with Krakauer method at 5 mA.

MiniPak QFN Electrical Specifications

$T_C = +25^\circ\text{C}$, Single Diode (see note).

Part Number HMPS-	Package Marking Code	Lead Code	Configur- ation	Minimum Breakdown Voltage V_{BR} (V)	Maximum Forward Voltage V_F (mV)	Maximum Forward Voltage V_F (V) @ I_F (mA)		Maximum Reverse Leakage I_R (nA) @ V_R (V)		Maximum Capacitance C_T (pF)	Typical Dynamic Resistance R_D (Ω) ^a
						0.5	10	100	1		
2822	3	2	Anti-parallel	15	340	0.5	10	100	1	1.0	12
2825	2	5	Parallel								
Test Conditions				$I_R = 100 \mu\text{A}$	$I_F = 1 \text{ mA}^b$					$V_F = 0\text{V}$, $f = 1 \text{ MHz}^c$	$I_F = 5 \text{ mA}$

a. $R_D = R^S + 5.2\Omega$ at 25°C and $I_f = 5 \text{ mA}$.

b. ΔV_F for diodes in pairs is 15 mV maximum at 1 mA.

c. ΔC_{T0} for diodes in pairs is 0.2 pF maximum.

NOTE Effective carrier lifetime (τ) for all these diodes is 100 ps maximum measured with Krakauer method at 5 mA.

Linear Equivalent Circuit Model Diode Chip

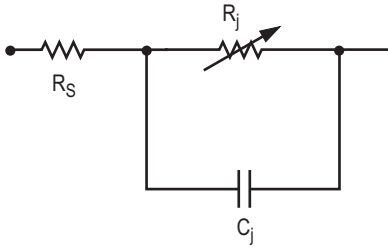

R_S = series resistance (see Table of SPICE parameters)

C_j = junction capacitance (see Table of SPICE parameters)

$$R_j = \frac{8.33 \times 10^{-5} nT}{I_b + I_s}$$

where

I_b = externally applied bias current in amps

I_s = saturation current (see table of SPICE parameters)

T = temperature, °K

n = ideality factor (see table of SPICE parameters)

Note:

To effectively model the packaged HSMS-282x product, please refer to Application Note AN1124.

SPICE Parameters

Parameter	Units	HMPS-282x
B_V	V	15
C_{J0}	pF	0.7
E_G	eV	0.60
I_{BV}	A	1E-4
I_S	A	2.2E28
N		1.08
R_S	Ω	8.0
P_B	V	0.65
P_T		2
M		0.5

MiniPak 1412 Linear Circuit Model of the Diode's Package

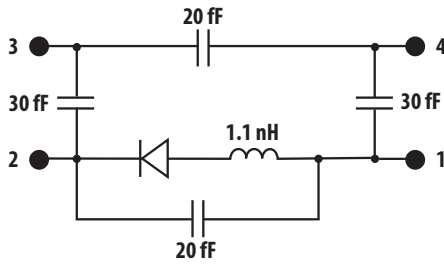

Single diode package (HMPx-x8x0)

Minipak QFN Linear Circuit Model of the Diode's Package

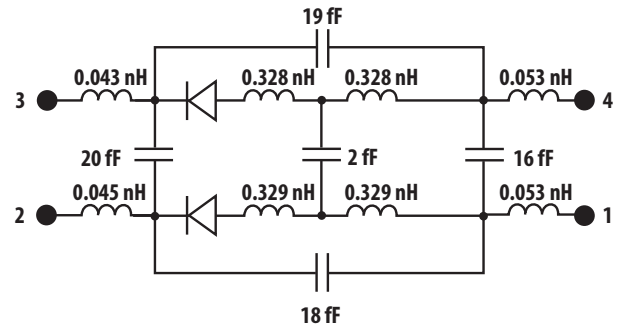

Parallel diode package (HMPx-x8x5)

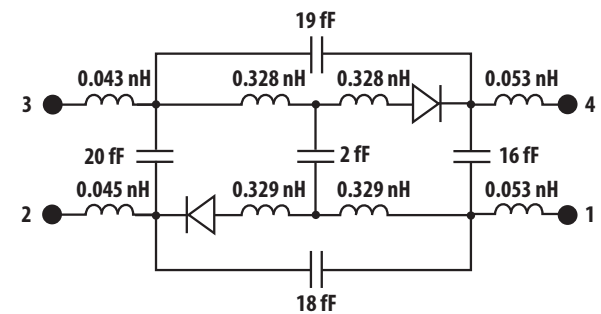

Anti-Parallel diode package (HMPx-x8x2)

MiniPak 1412 HMP5-282x Series Typical Performance

$T_C = 25^\circ\text{C}$ (unless otherwise noted), Single Diode

Figure 1 Forward Current vs. Forward Voltage at Temperatures

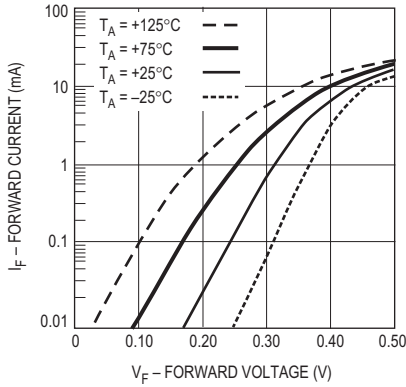

Figure 2 Reverse Current vs. Reverse Voltage at Temperatures

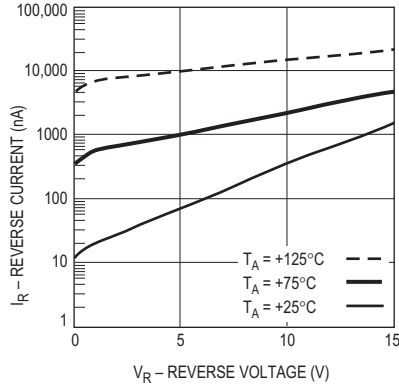

Figure 3 Total Capacitance vs. Reverse Voltage at 1 MHz

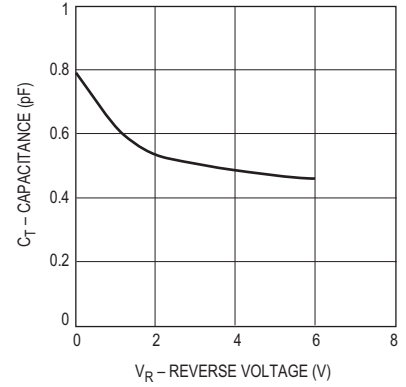

Figure 4 Dynamic Resistance vs. Forward Current

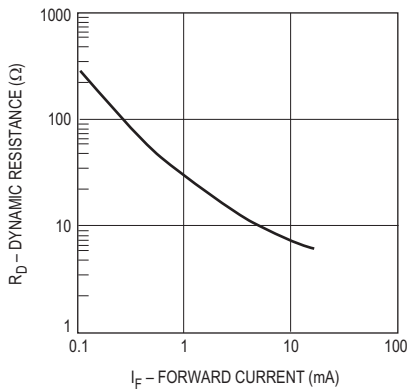

Figure 5 Typical V_f Match, Series Pairs and Quads at Mixer Bias Levels

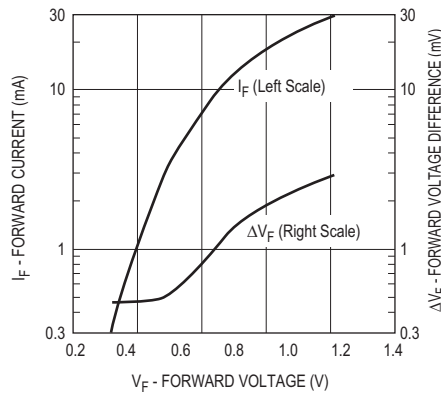

Figure 6 Typical V_f Match, Series Pairs at Detector Bias Levels

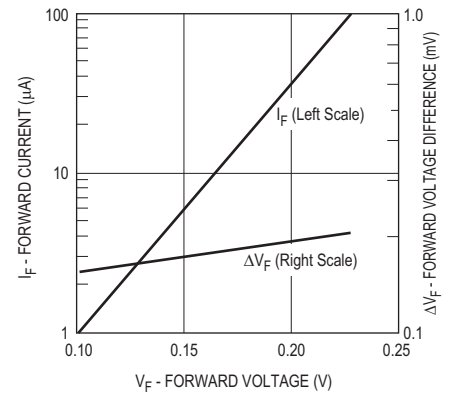

Figure 7 Typical Output Voltage vs. Input Power, Small Signal Detector Operating at 850 MHz

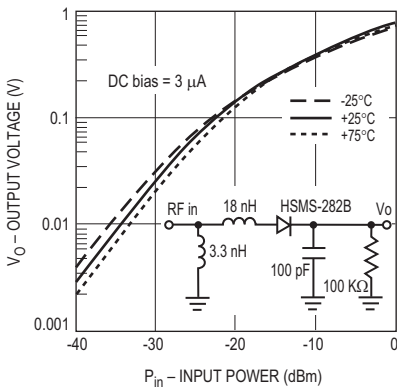

Figure 8 Typical Output Voltage vs. Input Power, Large Signal Detector Operating at 915 MHz

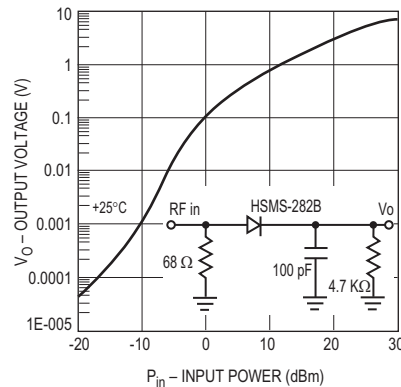
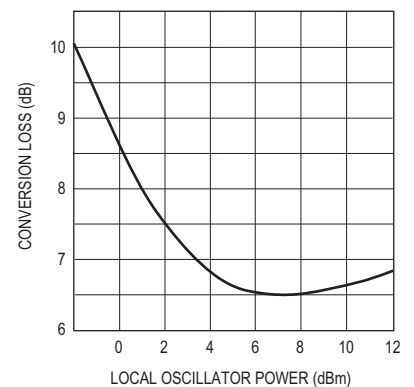

Figure 9 Typical Conversion Loss vs. L.O. Drive, 2.0 GHz (Ref. AN997)



MiniPak QFN HMPS-2825 Series Typical Performance

TC = 25°C (unless otherwise noted), Single Diode

Figure 10 Forward Current vs. Forward Voltage at Temperatures

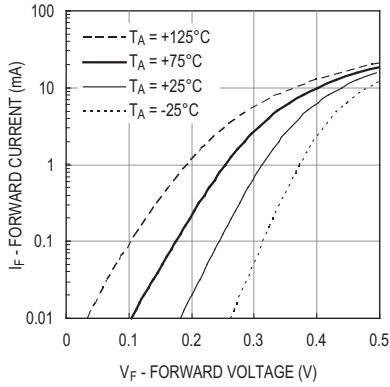

Figure 11 Reverse Current vs. Reverse Voltage at Temperatures

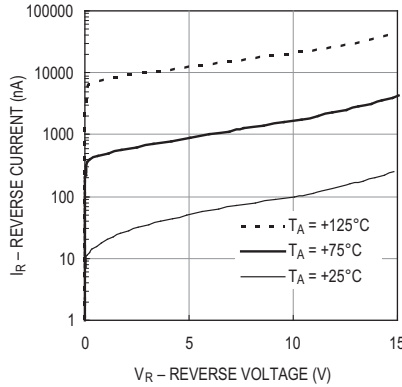

Figure 12 Total Capacitance vs. Reverse Voltage at 1 MHz

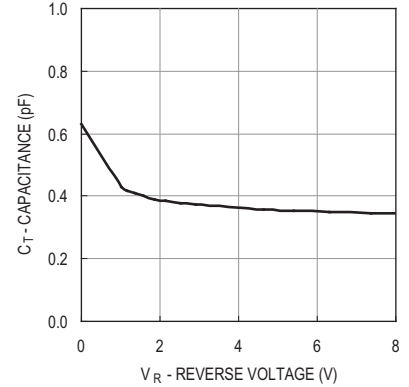

Figure 13 Dynamic Resistance vs. Forward Current

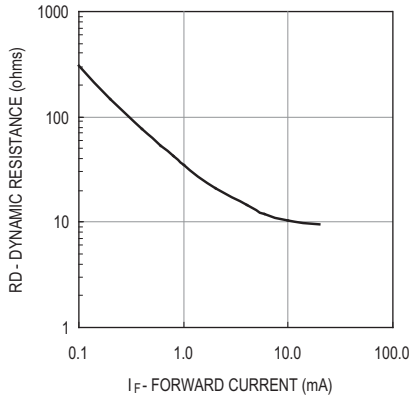

Figure 14 Typical Vf Match, Series Pairs and Quads at Mixer Bias Levels

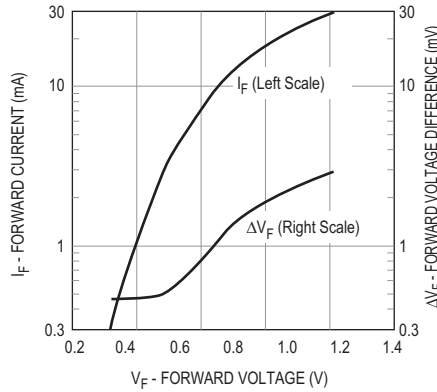

Figure 15 Typical Vf Match, Series Pairs at Detector Bias Levels

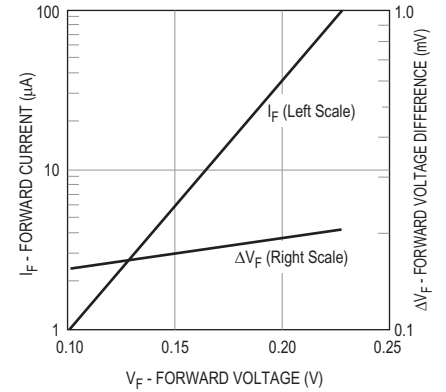
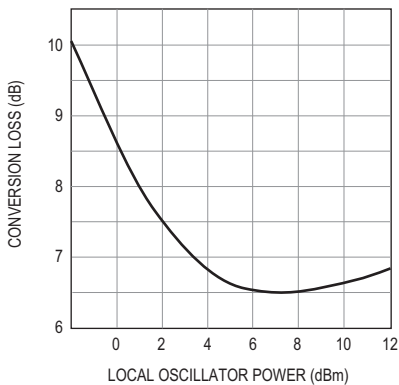

Figure 16 Typical Conversion Loss vs. L.O. Drive, 2.0 GHz (Ref. AN997)



Assembly Information

The MiniPak diode is mounted to the PCB or microstrip board using the pad pattern shown in [Figure 17](#).

Figure 17 PCB Pad Layout, MiniPak (dimensions in mm)

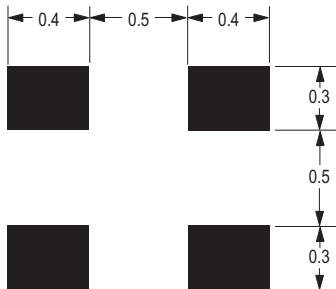

This mounting pad pattern is satisfactory for most applications. However, there are applications where a high degree of isolation is required between one diode and the other is required. For such applications, the mounting pad pattern of [Figure 18](#) is recommended.

Figure 18 PCB Pad Layout, High Isolation MiniPak (dimensions in mm)

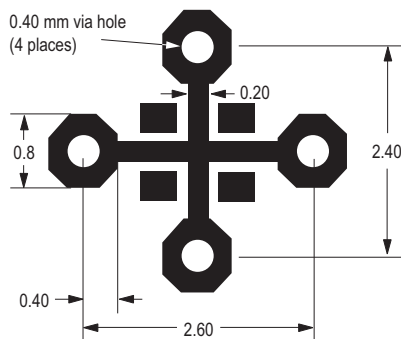

This pattern uses four via holes, connecting the crossed ground strip pattern to the ground plane of the board.

SMT Assembly

Reliable assembly of surface mount components is a complex process that involves many material, process, and equipment factors, including: method of heating (for example, IR or vapor phase reflow, wave soldering, and so on) circuit board material, conductor thickness and pattern, type of solder alloy, and the thermal conductivity and thermal mass of components. Components with a low mass, such as the MiniPak package, will reach solder reflow temperatures faster than those with a greater mass.

After ramping up from room temperature, the circuit board with components attached to it (held in place with solder paste) passes through one or more preheat zones. The preheat zones increase the temperature of the board and components to prevent thermal shock and begin evaporating solvents from the solder paste. The reflow zone briefly elevates the temperature sufficiently to produce a reflow of the solder.

The rates of change of temperature for the ramp-up and cool-down zones are chosen to be low enough to not cause deformation of the board or damage to components due to thermal shock. The maximum temperature in the reflow zone (T_{MAX}) should not exceed 255°C.

These parameters are typical for a surface mount assembly process for Broadcom diodes. As a general guideline, the circuit board and components should be exposed only to the minimum temperatures and times necessary to achieve a uniform reflow of solder.

MiniPak QFN Outline Drawing

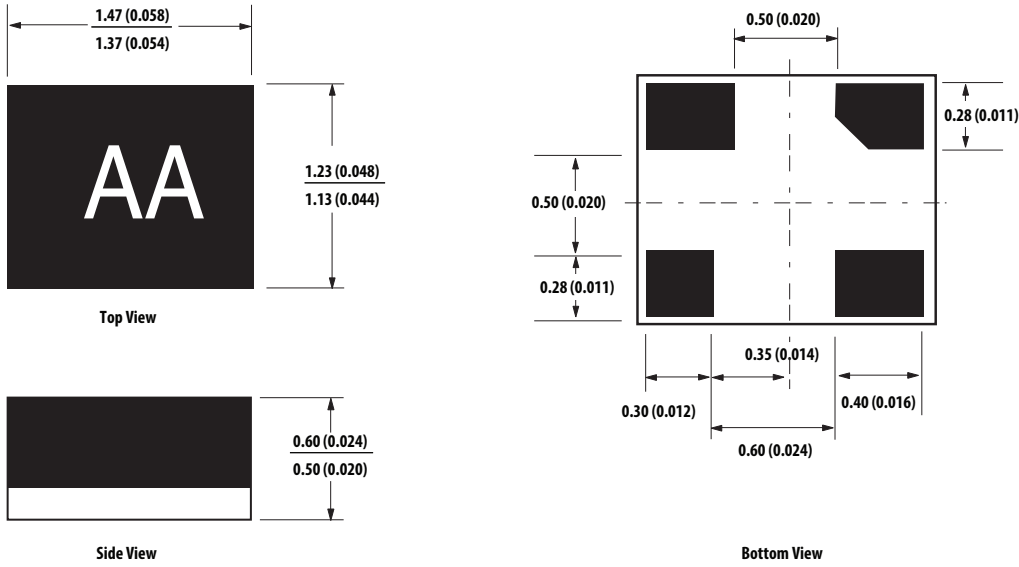

Dimensions are in millimeters (inches)

Ordering Information

Part Number	Number of Devices	Container
HMPS-282x-TR2	10000	13 Reel
HMPS-282x-TR1	3000	7 Reel
HMPS-282x-BLK	100	Antistatic bag

Device Orientation

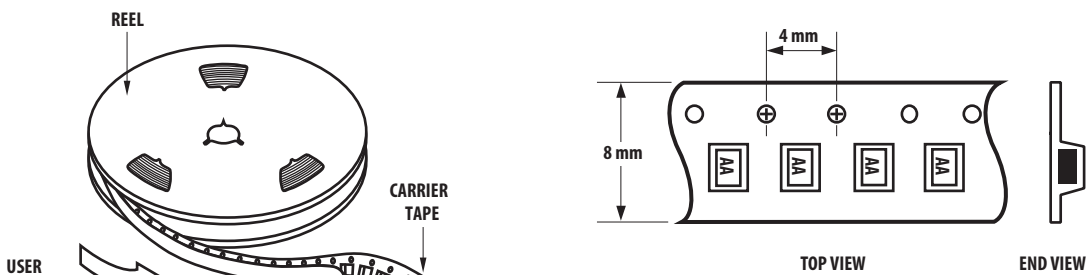

Note: "AA" represents package marking code. Package marking is right side up with carrier tape perforations at top. Conforms to Electronic Industries RS-481, "Taping of Surface Mounted Components for Automated Placement." Standard quantity is 3,000 devices per reel.

Tape Dimensions and Product Orientation for Outline 4T (MiniPak 1412 and MiniPak QFN)

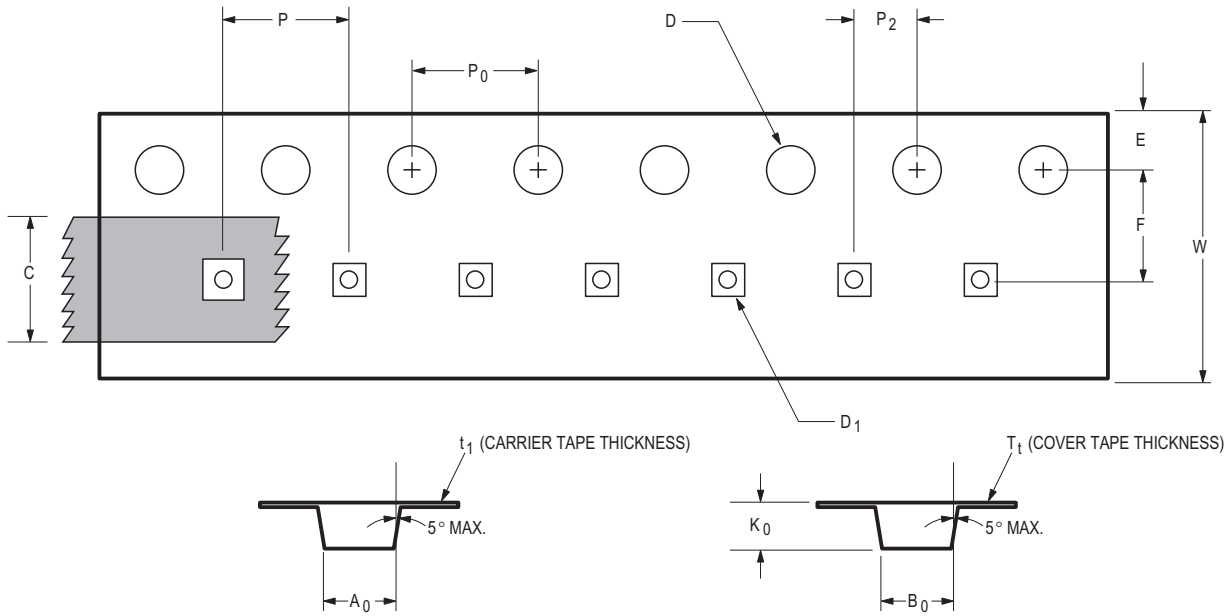

DESCRIPTION		SYMBOL	SIZE (mm)	SIZE (INCHES)
CAVITY	LENGTH	A ₀	1.40 ± 0.05	0.055 ± 0.002
	WIDTH	B ₀	1.63 ± 0.05	0.064 ± 0.002
	DEPTH	K ₀	0.80 ± 0.05	0.031 ± 0.002
	PITCH	P	4.00 ± 0.10	0.157 ± 0.004
	BOTTOM HOLE DIAMETER	D ₁	0.80 ± 0.05	0.031 ± 0.002
PERFORATION	DIAMETER	D	1.50 ± 0.10	0.060 ± 0.004
	PITCH	P ₀	4.00 ± 0.10	0.157 ± 0.004
	POSITION	E	1.75 ± 0.10	0.069 ± 0.004
CARRIER TAPE	WIDTH	W	8.00 + 0.30 - 0.10	0.315 + 0.012 - 0.004
	THICKNESS	t ₁	0.254 ± 0.02	0.010 ± 0.001
COVER TAPE	WIDTH	C	5.40 ± 0.10	0.213 ± 0.004
	TAPE THICKNESS	T _t	0.062 ± 0.001	0.002 ± 0.00004
DISTANCE	CAVITY TO PERFORATION (WIDTH DIRECTION)	F	3.50 ± 0.05	0.138 ± 0.002
	CAVITY TO PERFORATION (LENGTH DIRECTION)	P ₂	2.00 ± 0.05	0.079 ± 0.002

For product information and a complete list of distributors, please go to our web site: www.broadcom.com.

Broadcom, the pulse logo, Connecting everything, Avago Technologies, Avago, and the A logo are among the trademarks of Broadcom and/or its affiliates in the United States, certain other countries and/or the EU.

Copyright © 2019–2017 by Broadcom. All Rights Reserved.

The term "Broadcom" refers to Broadcom Limited and/or its subsidiaries. For more information, please visit www.broadcom.com.

Broadcom reserves the right to make changes without further notice to any products or data herein to improve reliability, function, or design.

Information furnished by Broadcom is believed to be accurate and reliable. However, Broadcom does not assume any liability arising out of the application or use of this information, nor the application or use of any product or circuit described herein, neither does it convey any license under its patent rights nor the rights of others.

AV02-0571EN – April 28, 2017

