



**MJD2955**  
**MJD3055**

## COMPLEMENTARY POWER TRANSISTORS

- STMicroelectronics PREFERRED SALESTYPES
- SURFACE-MOUNTING TO-252 (DPAK) POWER PACKAGE IN TAPE & REEL (SUFFIX "T4")
- ELECTRICALLY SIMILAR TO MJE2955T AND MJE3055T

### APPLICATIONS

- GENERAL PURPOSE SWITCHING AND AMPLIFIER

### DESCRIPTION

The MJD2955 and MJD3055 form complementary PNP-NPN pairs. They are manufactured using Epitaxial Base technology for cost-effective performance.

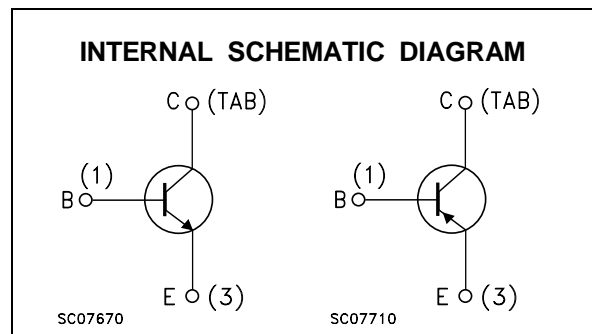
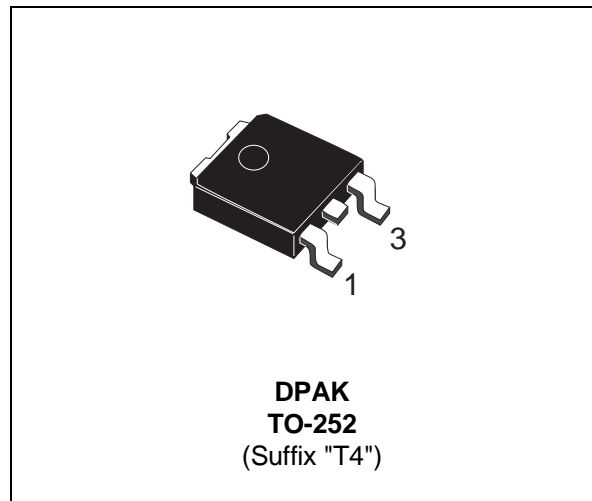

### ABSOLUTE MAXIMUM RATINGS

Symbol	Parameter	Value		Unit
		NPN	MJD3055	
		PNP	MJD2955	
$V_{CBO}$	Collector-Base Voltage ( $I_E = 0$ )		70	V
$V_{CEO}$	Collector-Emitter Voltage ( $I_B = 0$ )		60	V
$V_{EBO}$	Emitter-Base Voltage ( $I_C = 0$ )		5	V
$I_C$	Collector Current		10	A
$I_B$	Base Current		6	A
$P_{tot}$	Total Dissipation at $T_c = 25^\circ\text{C}$		20	W
$T_{stg}$	Storage Temperature		-65 to 150	$^\circ\text{C}$
$T_j$	Max. Operating Junction Temperature		150	$^\circ\text{C}$

For PNP type voltage and current values are negative.

# MJD2955 / MJD3055

## THERMAL DATA

R <sub>thj-case</sub>	Thermal Resistance Junction-case	Max	6.25	°C/W
R <sub>thj-amb</sub>	Thermal Resistance Junction-ambient	Max	100	°C/W

## ELECTRICAL CHARACTERISTICS (T<sub>case</sub> = 25 °C unless otherwise specified)

Symbol	Parameter	Test Conditions	Min.	Typ.	Max.	Unit
I <sub>CEX</sub>	Collector Cut-off Current (V <sub>BE</sub> = -1.5 V)	V <sub>CE</sub> = 70 V V <sub>CE</sub> = 70 V T <sub>j</sub> = 150 °C			20 2	μA mA
I <sub>CBO</sub>	Collector Cut-off Current (I <sub>E</sub> = 0)	V <sub>CB</sub> = 70 V V <sub>CB</sub> = 70 V T <sub>j</sub> = 150 °C			20 2	μA mA
I <sub>CEO</sub>	Collector Cut-off Current (I <sub>B</sub> = 0)	V <sub>CE</sub> = 30 V			50	μA
I <sub>EBO</sub>	Emitter Cut-off Current (I <sub>C</sub> = 0)	V <sub>EB</sub> = 5 V			0.5	mA
V <sub>CEO(sus)*</sub>	Collector-Emitter Sustaining Voltage (I <sub>B</sub> = 0)	I <sub>C</sub> = 30 mA	60			V
V <sub>CE(sat)*</sub>	Collector-Emitter Saturation Voltage	I <sub>C</sub> = 4 A I <sub>B</sub> = 0.4 A I <sub>C</sub> = 10 A I <sub>B</sub> = 3.3 A			1.1 8	V V
V <sub>BE(on)*</sub>	Base-Emitter Voltage	I <sub>C</sub> = 4 A V <sub>CE</sub> = 4 V			1.8	V
h <sub>FE*</sub>	DC Current Gain	I <sub>C</sub> = 4 A V <sub>CE</sub> = 4 V I <sub>C</sub> = 10 A V <sub>CE</sub> = 4 V	20 5		100	
f <sub>T</sub>	Transition Frequency	I <sub>C</sub> = 0.5 A V <sub>CE</sub> = 10 V f = 500 KHz	2			MHz

\* Pulsed: Pulse duration = 300 μs, duty cycle 1.5 %  
For PNP type voltage and current values are negative.

Target specification

## Safe Operating Area

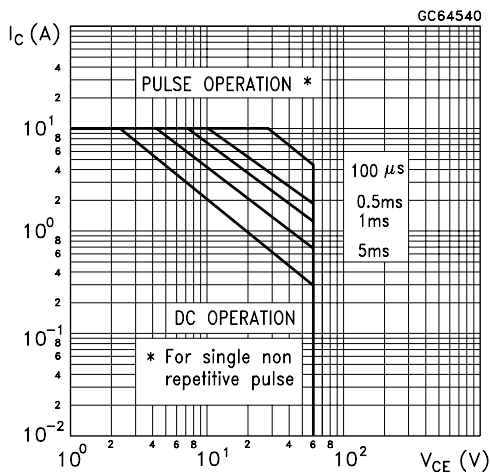

## Derating Curves

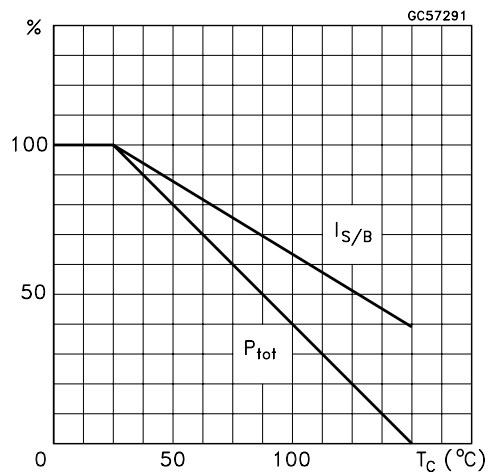

DC Current Gain (NPN type)

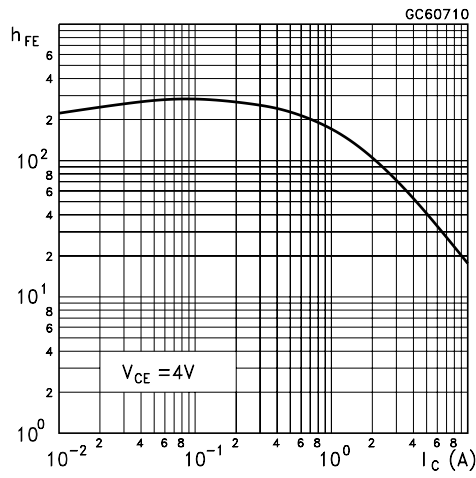

DC Current Gain (PNP type)

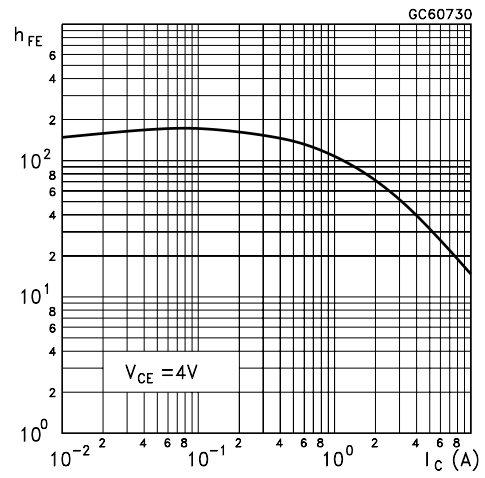

DC Transconductance (NPN type)

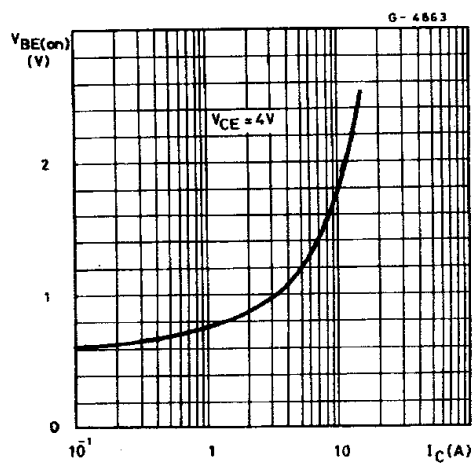

DC Transconductance (PNP type)

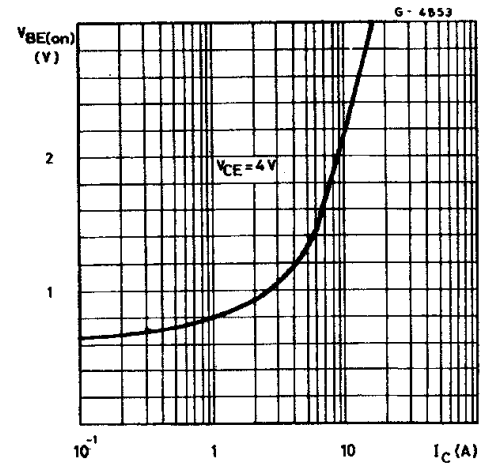

Collector-Emitter Saturation Voltage (NPN type)

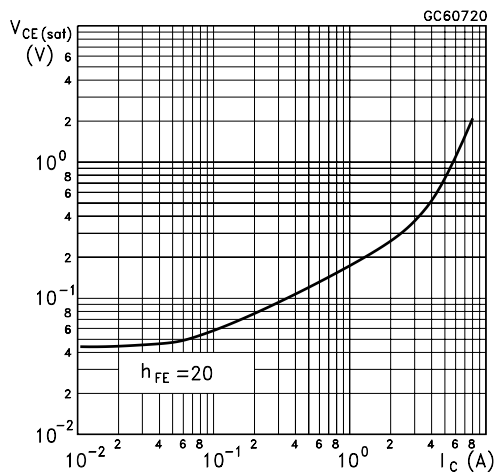

Collector-Emitter Saturation Voltage (PNP type)

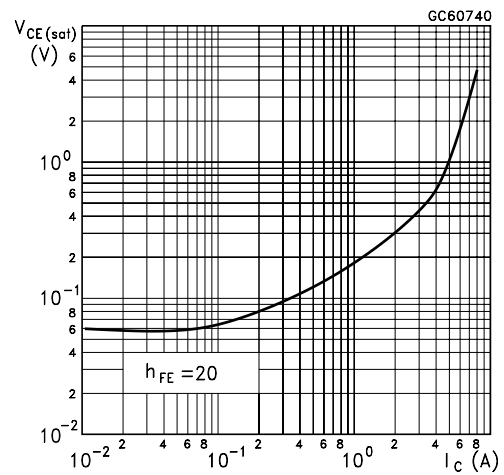

Target specification

Base-Emitter Saturation Voltage (NPN type)

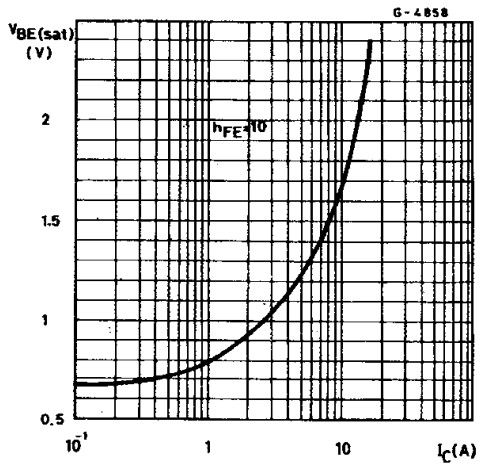

Base-Emitter Saturation Voltage (PNP type)

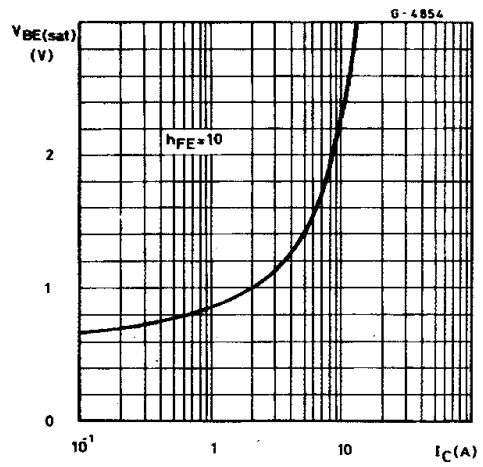

Transition Frequency (NPN type)

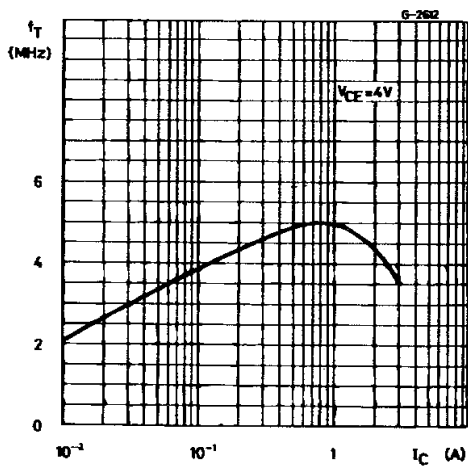

Transition Frequency (PNP type)

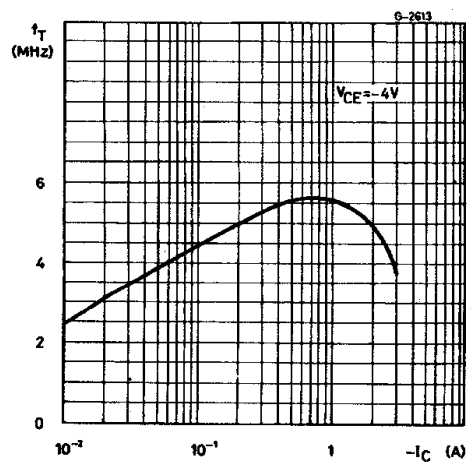

Target specification

TO-252 (DPAK) MECHANICAL DATA

DIM.	mm			inch		
	MIN.	TYP.	MAX.	MIN.	TYP.	MAX.
A	2.20		2.40	0.087		0.094
A1	0.90		1.10	0.035		0.043
A2	0.03		0.23	0.001		0.009
B	0.64		0.90	0.025		0.035
B2	5.20		5.40	0.204		0.213
C	0.45		0.60	0.018		0.024
C2	0.48		0.60	0.019		0.024
D	6.00		6.20	0.236		0.244
E	6.40		6.60	0.252		0.260
G	4.40		4.60	0.173		0.181
H	9.35		10.10	0.368		0.398
L2		0.8			0.031	
L4	0.60		1.00	0.024		0.039
V2	0°		8°	0°		0°

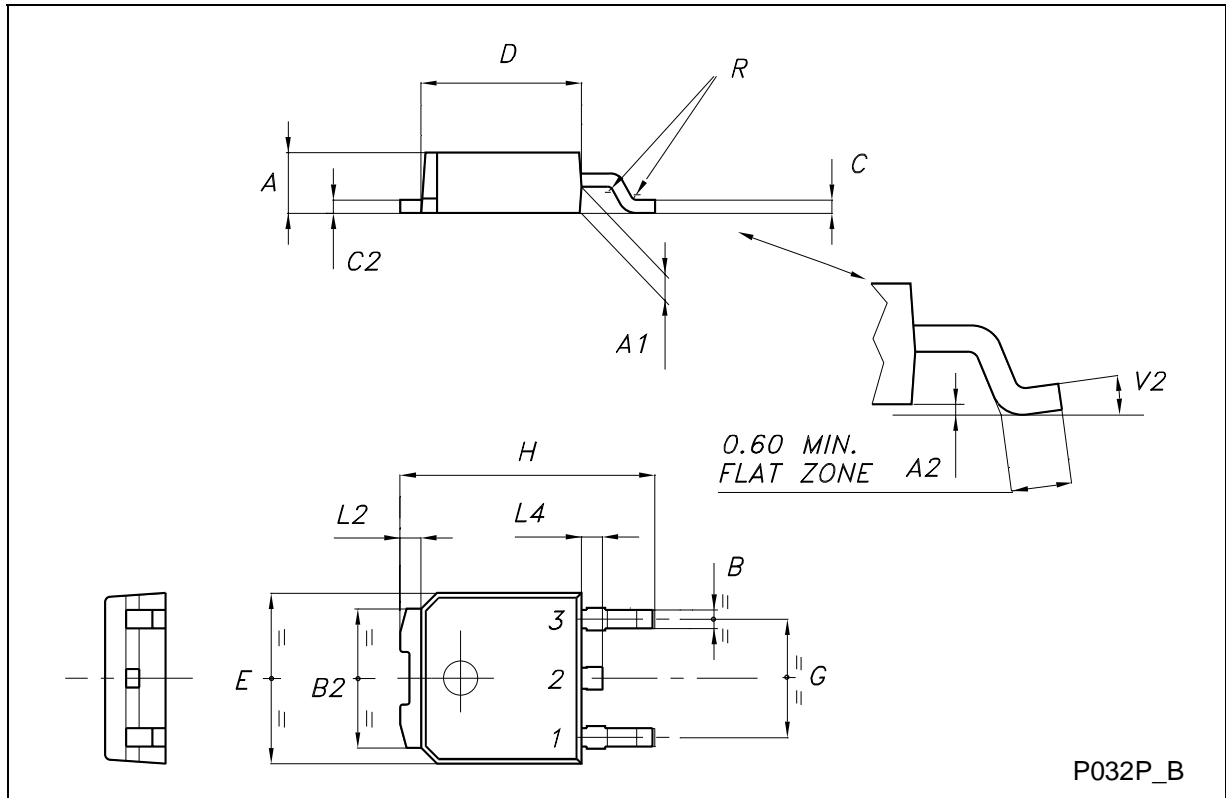

Target specification

Information furnished is believed to be accurate and reliable. However, STMicroelectronics assumes no responsibility for the consequences of use of such information nor for any infringement of patents or other rights of third parties which may result from its use. No license is granted by implication or otherwise under any patent or patent rights of STMicroelectronics. Specification mentioned in this publication are subject to change without notice. This publication supersedes and replaces all information previously supplied. STMicroelectronics products are not authorized for use as critical components in life support devices or systems without express written approval of STMicroelectronics.

The ST logo is a trademark of STMicroelectronics

© 2002 STMicroelectronics – Printed in Italy – All Rights Reserved

STMicroelectronics GROUP OF COMPANIES

Australia - Brazil - Canada - China - Finland - France - Germany - Hong Kong - India - Israel - Italy - Japan - Malaysia - Malta - Morocco - Singapore - Spain - Sweden - Switzerland - United Kingdom - United States.

<http://www.st.com>