

2N6338, 2N6341

High-Power NPN Silicon Transistors

... designed for use in industrial–military power amplifier and switching circuit applications.

- High Collector–Emitter Sustaining Voltage –
 $V_{CEO(sus)} = 100 \text{ Vdc (Min) – 2N6338}$
 $= 150 \text{ Vdc (Min) – 2N6341}$
- High DC Current Gain –
 $h_{FE} = 30 - 120 @ I_C = 10 \text{ Adc}$
 $= 12 \text{ (Min) @ } I_C = 25 \text{ Adc}$
- Low Collector–Emitter Saturation Voltage –
 $V_{CE(sat)} = 1.0 \text{ Vdc (Max) @ } I_C = 10 \text{ Adc}$
- Fast Switching Times @ $I_C = 10 \text{ Adc}$
 $t_r = 0.3 \text{ ms (Max)}$
 $t_s = 1.0 \text{ ms (Max)}$
 $t_f = 0.25 \text{ ms (Max)}$
- Pb–Free Packages are Available

*MAXIMUM RATINGS

Rating	Symbol	2N6338	2N6341	Unit
Collector–Base Voltage	V_{CB}	120	180	Vdc
Collector–Emitter Voltage	V_{CEO}	100	150	Vdc
Emitter–Base Voltage	V_{EB}	6.0		Vdc
Collector Current Continuous Peak	I_C	25 50		Adc
Base Current	I_B	10		Adc
Total Device Dissipation @ $T_C = 25^\circ\text{C}$ Derate above 25°C	P_D	200 1.14		W W/ $^\circ\text{C}$
Operating and Storage Junction Temperature Range	T_J, T_{stg}	–65 to +200		$^\circ\text{C}$

THERMAL CHARACTERISTICS

Characteristic	Symbol	Max	Unit
Thermal Resistance, Junction to Case	θ_{JC}	0.875	$^\circ\text{C/W}$

Stresses exceeding Maximum Ratings may damage the device. Maximum Ratings are stress ratings only. Functional operation above the Recommended Operating Conditions is not implied. Extended exposure to stresses above the Recommended Operating Conditions may affect device reliability.

*Indicates JEDEC Registered Data.



ON Semiconductor®

<http://onsemi.com>

25 AMPERE POWER TRANSISTORS NPN SILICON

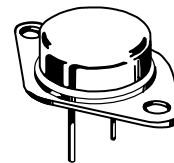

TO–204AA
CASE 1–07

ORDERING INFORMATION

Device	Package	Shipping
2N6338	TO–204AA	100 Units / Tray
2N6338G	TO–204AA (Pb–Free)	100 Units / Tray
2N6341	TO–204AA	100 Units / Tray
2N6341G	TO–204AA (Pb–Free)	100 Units / Tray

2N6338, 2N6341

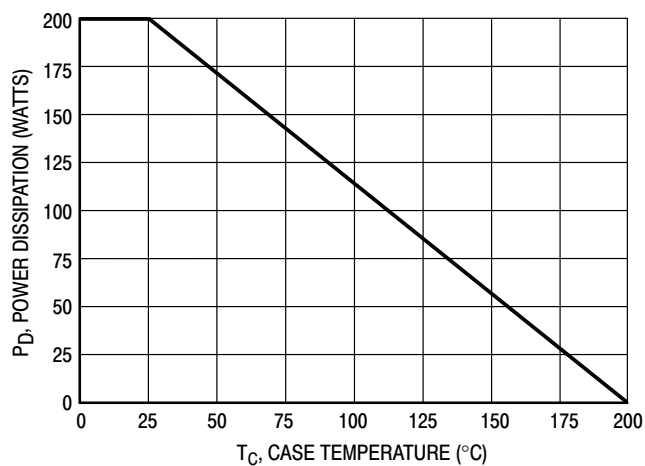

Figure 1. Power Derating

***ELECTRICAL CHARACTERISTICS** (T_C = 25°C unless otherwise noted)

Characteristic	Symbol	Min	Max	Unit	
OFF CHARACTERISTICS					
Collector-Emitter Sustaining Voltage (1) (I _C = 50 mAdc, I _B = 0)	2N6338 2N6341	V _{CEO(sus)}	100 150	– –	Vdc
Collector Cutoff Current (V _{CE} = 50 Vdc, I _B = 0) (V _{CE} = 75 Vdc, I _B = 0)	2N6338 2N6341	I _{CEO}	– –	50 50	μAdc
Collector Cutoff Current (V _{CE} = Rated V _{CEO} , V _{EB(off)} = 1.5 Vdc) (V _{CE} = Rated V _{CEO} , V _{EB(off)} = 1.5 Vdc, T _C = 150°C)		I _{CEx}	– –	10 1.0	μAdc mAdc
Collector Cutoff Current (V _{CB} = Rated V _{CB} , I _E = 0)		I _{CBO}	–	10	μAdc
Emitter Cutoff Current (V _{BE} = 6.0 Vdc, I _C = 0)		I _{EBO}	–	100	μAdc

ON CHARACTERISTICS (1)

DC Current Gain (I _C = 0.5 Adc, V _{CE} = 2.0 Vdc) (I _C = 10 Adc, V _{CE} = 2.0 Vdc) (I _C = 25 Adc, V _{CE} = 2.0 Vdc)	h _{FE}	50 30 12	– 120 –	–
Collector Emitter Saturation Voltage (I _C = 10 Adc, I _B = 1.0 Adc) (I _C = 25 Adc, I _B = 2.5 Adc)	V _{CE(sat)}	– –	1.0 1.8	Vdc
Base-Emitter Saturation Voltage (I _C = 10 Adc, I _B = 1.0 Adc) (I _C = 25 Adc, I _B = 2.5 Adc)	V _{BE(sat)}	– –	1.8 2.5	Vdc
Base-Emitter On Voltage (I _C = 10 Adc, V _{CE} = 2.0 Vdc)	V _{BE(on)}	–	1.8	Vdc

DYNAMIC CHARACTERISTICS

Current-Gain - Bandwidth Product (2) (I _C = 1.0 Adc, V _{CE} = 10 Vdc, f _{test} = 10 MHz)	f _T	40	–	MHz
Output Capacitance (V _{CB} = 10 Vdc, I _E = 0, f = 0.1 MHz)	C _{ob}	–	300	pF

SWITCHING CHARACTERISTICS

Rise Time (V _{CC} ≈ 80 Vdc, I _C = 10Adc, I _{B1} = 1.0 Adc, V _{BE(off)} = 6.0 Vdc)	t _r	–	0.3	μs
Storage Time (V _{CC} ≈ 80 Vdc, I _C = 10 Adc, I _{B1} = I _{B2} = 1.0 Adc)	t _s	–	1.0	μs
Fall Time (V _{CC} ≈ 80 Vdc, I _C = 10 Adc, I _{B1} = I _{B2} = 1.0 Adc)	t _f	–	0.25	μs

*Indicates JEDEC Registered Data.

(1) Pulse Test: Pulse Width ≤ 300 μs, Duty Cycle ≤ 2.0%.

(2) f_T = |h_{fe}| • f_{test}.

2N6338, 2N6341

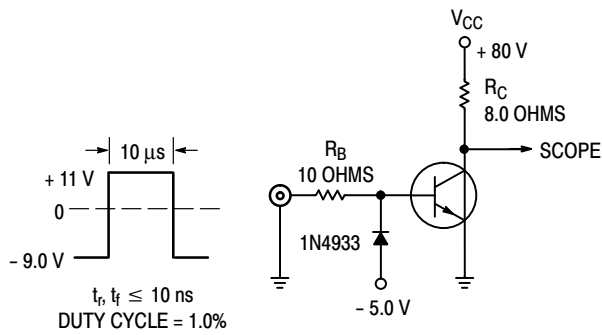

NOTE: For information on Figures 3 and 6, R_B and R_C were varied to obtain desired test conditions.

Figure 2. Switching Time Test Circuit

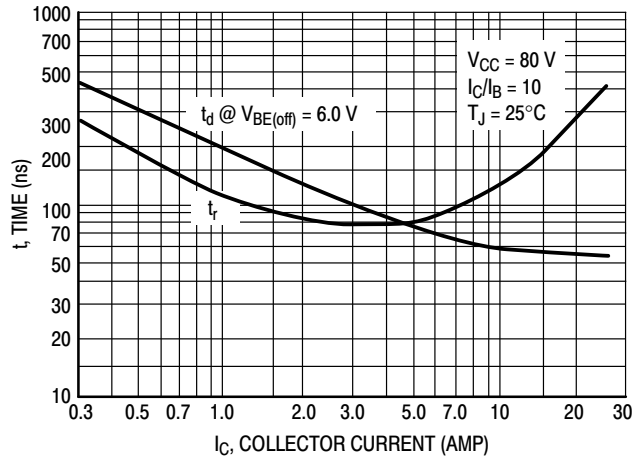

Figure 3. Turn-On Time

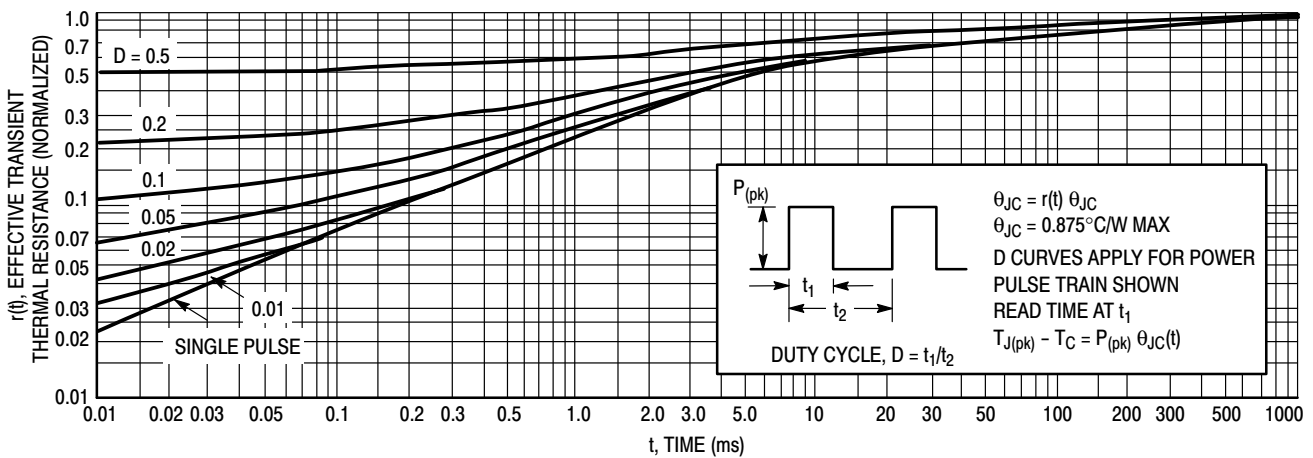

Figure 4. Thermal Response

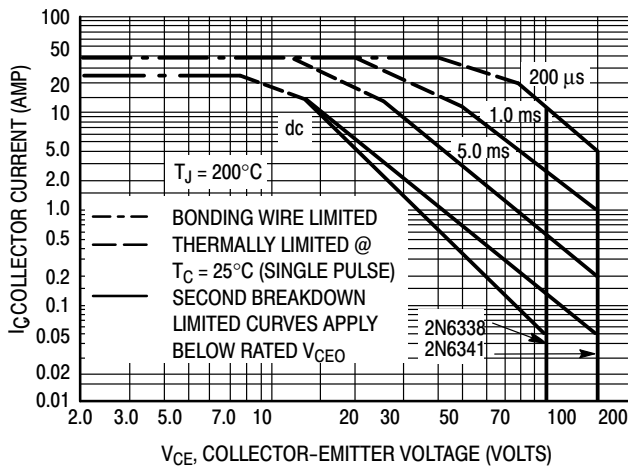

Figure 5. Active Region Safe Operating Area

There are two limitations on the power handling ability of a transistor: average junction temperature and second breakdown. Safe operating area curves indicate I_C - V_{CE} limits of the transistor that must be observed for reliable operation; i.e., the transistor must not be subjected to greater dissipation than the curves indicate.

The data of Figure 5 is based on $T_{J(pk)} = 200^\circ\text{C}$; T_C is variable depending on conditions. Second breakdown pulse limits are valid for duty cycles to 10% provided $T_{J(pk)} \leq 200^\circ\text{C}$. $T_{J(pk)}$ may be calculated from the data in Figure 4. At high case temperatures, thermal limitations will reduce the power that can be handled to values less than the limitations imposed by second breakdown.

2N6338, 2N6341

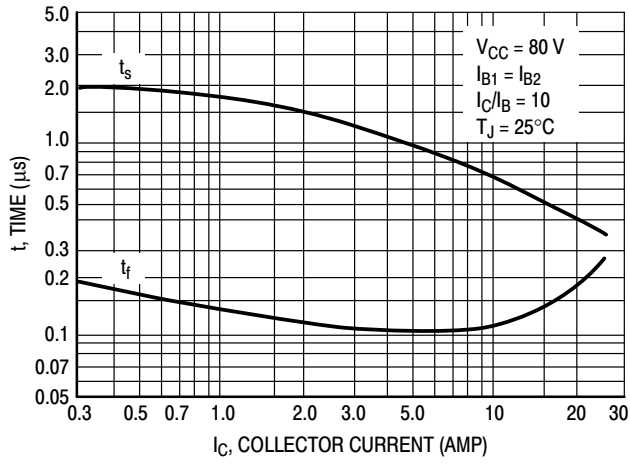

Figure 6. Turn-Off Time

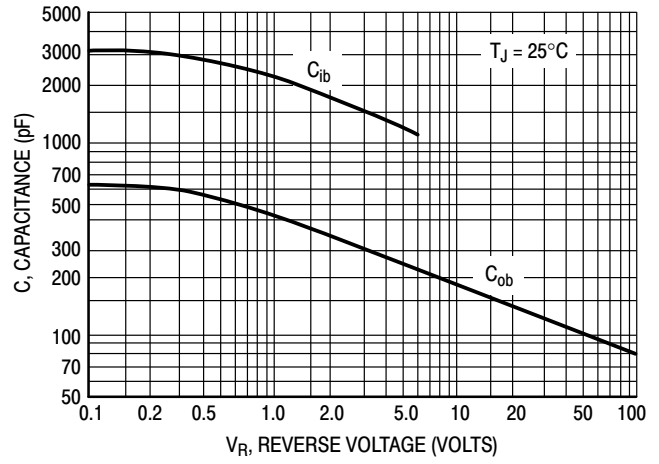

Figure 7. Capacitance

MECHANICAL CASE OUTLINE PACKAGE DIMENSIONS

ON Semiconductor



TO-204 (TO-3)
CASE 1-07
ISSUE Z

DATE 05/18/1988



SCALE 1:1



NOTES:

1. DIMENSIONING AND TOLERANCING PER ANSI Y14.5M, 1982.
2. CONTROLLING DIMENSION: INCH.
3. ALL RULES AND NOTES ASSOCIATED WITH REFERENCED TO-204AA OUTLINE SHALL APPLY.

DIM	INCHES		MILLIMETERS	
	MIN	MAX	MIN	MAX
A	1.550 REF	---	39.37 REF	---
B	---	1.050	---	26.67
C	0.250	0.335	6.35	8.51
D	0.038	0.043	0.97	1.09
E	0.055	0.070	1.40	1.77
G	0.430 BSC		10.92 BSC	
H	0.215 BSC		5.46 BSC	
K	0.440	0.480	11.18	12.19
L	0.665 BSC		16.89 BSC	
N	---	0.830	---	21.08
Q	0.151	0.165	3.84	4.19
U	1.187 BSC		30.15 BSC	
V	0.131	0.188	3.33	4.77

- | | | | | |
|--|--|---|---|---|
| <p>STYLE 1:
PIN 1. BASE
2. EMITTER
CASE: COLLECTOR</p> | <p>STYLE 2:
PIN 1. BASE
2. COLLECTOR
CASE: EMITTER</p> | <p>STYLE 3:
PIN 1. GATE
2. SOURCE
CASE: DRAIN</p> | <p>STYLE 4:
PIN 1. GROUND
2. INPUT
CASE: OUTPUT</p> | <p>STYLE 5:
PIN 1. CATHODE
2. EXTERNAL TRIP/DELAY
CASE: ANODE</p> |
| <p>STYLE 6:
PIN 1. GATE
2. EMITTER
CASE: COLLECTOR</p> | <p>STYLE 7:
PIN 1. ANODE
2. OPEN
CASE: CATHODE</p> | <p>STYLE 8:
PIN 1. CATHODE #1
2. CATHODE #2
CASE: ANODE</p> | <p>STYLE 9:
PIN 1. ANODE #1
2. ANODE #2
CASE: CATHODE</p> | |

ON Semiconductor and are trademarks of Semiconductor Components Industries, LLC (SCILLC). SCILLC reserves the right to make changes without further notice to any products herein. SCILLC makes no warranty, representation or guarantee regarding the suitability of its products for any particular purpose, nor does SCILLC assume any liability arising out of the application or use of any product or circuit, and specifically disclaims any and all liability, including without limitation special, consequential or incidental damages. "Typical" parameters which may be provided in SCILLC data sheets and/or specifications can and do vary in different applications and actual performance may vary over time. All operating parameters, including "Typicals" must be validated for each customer application by customer's technical experts. SCILLC does not convey any license under its patent rights nor the rights of others. SCILLC products are not designed, intended, or authorized for use as components in systems intended for surgical implant into the body, or other applications intended to support or sustain life, or for any other application in which the failure of the SCILLC product could create a situation where personal injury or death may occur. Should Buyer purchase or use SCILLC products for any such unintended or unauthorized application, Buyer shall indemnify and hold SCILLC and its officers, employees, subsidiaries, affiliates, and distributors harmless against all claims, costs, damages, and expenses, and reasonable attorney fees arising out of, directly or indirectly, any claim of personal injury or death associated with such unintended or unauthorized use, even if such claim alleges that SCILLC was negligent regarding the design or manufacture of the part. SCILLC is an Equal Opportunity/Affirmative Action Employer.

onsemi, **Onsemi**, and other names, marks, and brands are registered and/or common law trademarks of Semiconductor Components Industries, LLC dba "**onsemi**" or its affiliates and/or subsidiaries in the United States and/or other countries. **onsemi** owns the rights to a number of patents, trademarks, copyrights, trade secrets, and other intellectual property. A listing of **onsemi**'s product/patent coverage may be accessed at www.onsemi.com/site/pdf/Patent-Marking.pdf. **onsemi** reserves the right to make changes at any time to any products or information herein, without notice. The information herein is provided "as-is" and **onsemi** makes no warranty, representation or guarantee regarding the accuracy of the information, product features, availability, functionality, or suitability of its products for any particular purpose, nor does **onsemi** assume any liability arising out of the application or use of any product or circuit, and specifically disclaims any and all liability, including without limitation special, consequential or incidental damages. Buyer is responsible for its products and applications using **onsemi** products, including compliance with all laws, regulations and safety requirements or standards, regardless of any support or applications information provided by **onsemi**. "Typical" parameters which may be provided in **onsemi** data sheets and/or specifications can and do vary in different applications and actual performance may vary over time. All operating parameters, including "Typicals" must be validated for each customer application by customer's technical experts. **onsemi** does not convey any license under any of its intellectual property rights nor the rights of others. **onsemi** products are not designed, intended, or authorized for use as a critical component in life support systems or any FDA Class 3 medical devices or medical devices with a same or similar classification in a foreign jurisdiction or any devices intended for implantation in the human body. Should Buyer purchase or use **onsemi** products for any such unintended or unauthorized application, Buyer shall indemnify and hold **onsemi** and its officers, employees, subsidiaries, affiliates, and distributors harmless against all claims, costs, damages, and expenses, and reasonable attorney fees arising out of, directly or indirectly, any claim of personal injury or death associated with such unintended or unauthorized use, even if such claim alleges that **onsemi** was negligent regarding the design or manufacture of the part. **onsemi** is an Equal Opportunity/Affirmative Action Employer. This literature is subject to all applicable copyright laws and is not for resale in any manner.

PUBLICATION ORDERING INFORMATION

LITERATURE FULFILLMENT:

Email Requests to: orderlit@onsemi.com

onsemi Website: www.onsemi.com

TECHNICAL SUPPORT

North American Technical Support:
Voice Mail: 1 800-282-9855 Toll Free USA/Canada
Phone: 011 421 33 790 2910

Europe, Middle East and Africa Technical Support:

Phone: 00421 33 790 2910

For additional information, please contact your local Sales Representative