

SUCCESSIVE DETECTION LOG VIDEO AMPLIFIER (SDLVA) 1 - 20 GHz

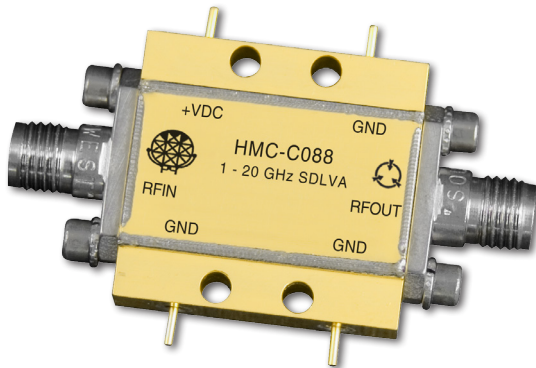

Typical Applications

The HMC-C088 is ideal for:

- EW, ELINT & IFM Receivers
- DF Radar Systems
- ECM Systems
- Broadband Test & Measurement
- Power Measurement & Control Circuits
- Military & Space Applications

Functional Diagram

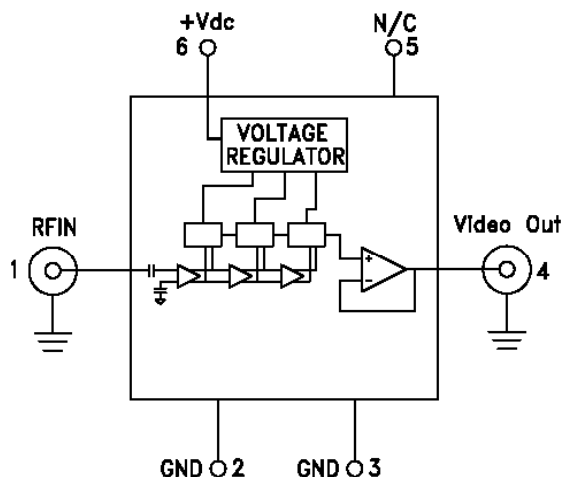

Electrical Specifications, $T_A = +25^\circ\text{C}$ $V_{dc} = +12\text{V}$

Parameter	Conditions	Typ.	Units
Input Frequency Range		1 - 20	GHz
Frequency Flatness	Pin= -30 dBm	±2	dB
Log Linearity	Pin= -50 dBm to +0 dBm	±1	dBm
Log Linearity over Temperature	-55 to +85° C, Pin= -30 dBm	±1	dB
Minimum Logging Range	to ±3 dB error	-54	dBm
Maximum Logging Range	to ±3 dB error	+5	dBm
Input Return Loss		9	dB
Log Video Minimum Output Voltage		0.9	V

Features

- 1 to 20 GHz Operation
- High Logging Range: 59 dB
- Output Frequency Flatness: ±2 dB
- Internal Voltage Regulation
- Fast Rise/Fall Times: 2/7 ns
- Hermetically Sealed Module
- Single Positive Supply: +7V to +16V
- 55 °C to +85 °C Operating Temperature

General Description

The HMC-C088 is a Successive Detection Log Video Amplifier (SDLVA) which operates from 1 to 20 GHz. The HMC-C088 provides a logging range of 59 dB.

This product comes standard with two female SMA field replaceable connectors but can also be used with blind mate SMP connectors or as a drop-in module. The package size measures 1.086 x 0.85 x 0.23" (27.58 x 21.6 x 5.84 mm) making it ideal for environmentally robust applications where space is limited.

The HMC-C088 has an integrated voltage regulator that allows the SDLVA to operate from a single supply between +7 and +16V without any appreciable change in performance.

**SUCCESSIVE DETECTION LOG VIDEO AMPLIFIER (SDLVA)
1 - 20 GHz**

Electrical Specifications, (continued)

Parameter	Conditions	Typ.	Units
Log Video Maximum Output Voltage		1.5	V
Log Video Output Rise Time	Pin = -20 dBm, 10% to 90%	2	ns
Log Video Output Fall Time	Pin = -20 dBm, 90% to 10%	7	ns
Vdc Voltage Range	7 - 16	12	V
Log Video Recovery Time	-50 dBm to 0 dBm	21	ns
Log Video Output Slope		14	mV/dB
Log Video Output Slope Variation over Temperature	@ 10 GHz	5	μV/dB°C
Log Video Propagation Delay		3	ns
Supply Current (I _{dc})		86	mA

Error Flatness vs. Input Power Over Frequency

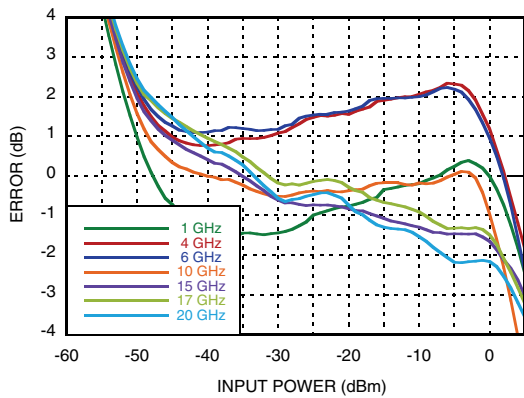

X-Band Error Flatness vs. Input Power Over Frequency

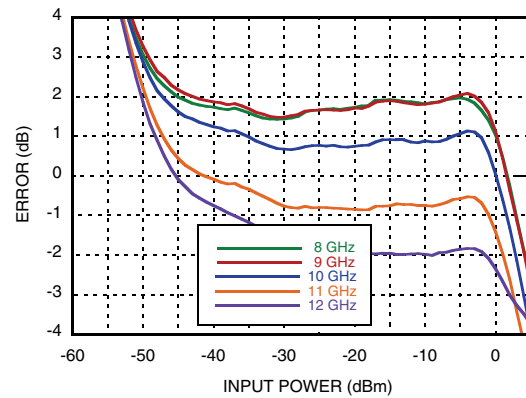

VIDEO OUT & Error vs. Input Power, Fin= 1 GHz

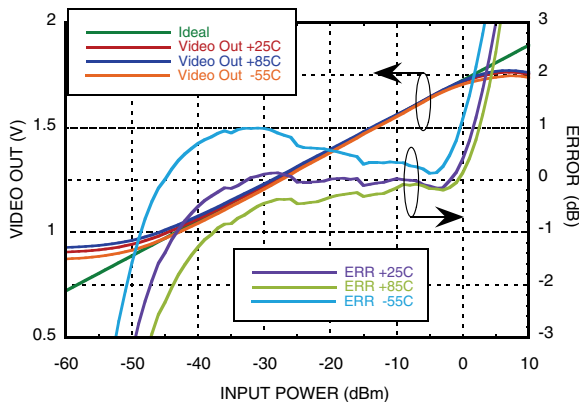

VIDEO OUT & Error vs. Input Power, Fin= 4 GHz

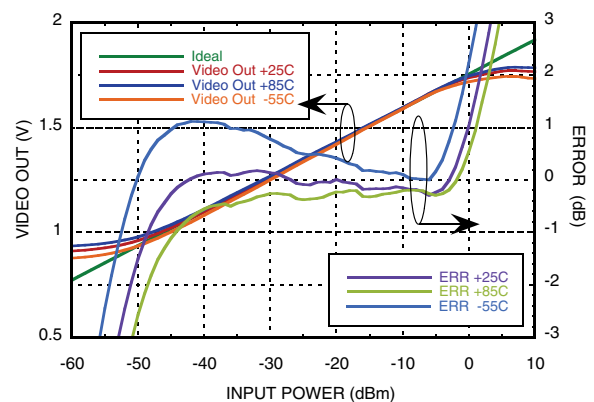

Information furnished by Analog Devices is believed to be accurate and reliable. However, no responsibility is assumed by Analog Devices for its use, nor for any infringements of patents or other rights of third parties that may result from its use. Specifications subject to change without notice. No license is granted by implication or otherwise under any patent or patent rights of Analog Devices. Trademarks and registered trademarks are the property of their respective owners.

For price, delivery, and to place orders: Analog Devices, Inc., One Technology Way, P.O. Box 9106, Norwood, MA 02062-9106 Phone: 781-329-4700 • Order online at www.analog.com Application Support: Phone: 1-800-ANALOG-D

**SUCCESSIVE DETECTION LOG VIDEO AMPLIFIER (SDLVA)
1 - 20 GHz**

SDLVAS - CONNECTORIZED

VIDEO OUT & Error vs. Input Power, F_{in} = 6 GHz

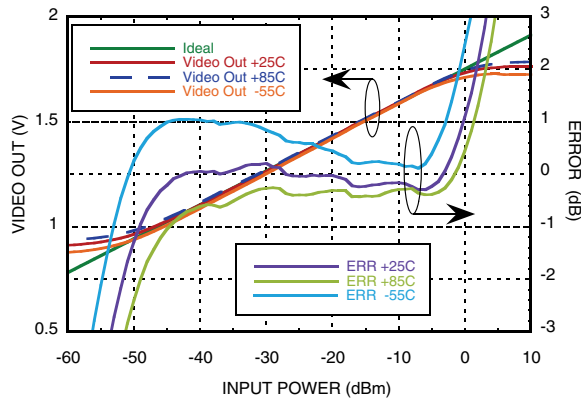

VIDEO OUT & Error vs. Input Power, F_{in} = 10 GHz

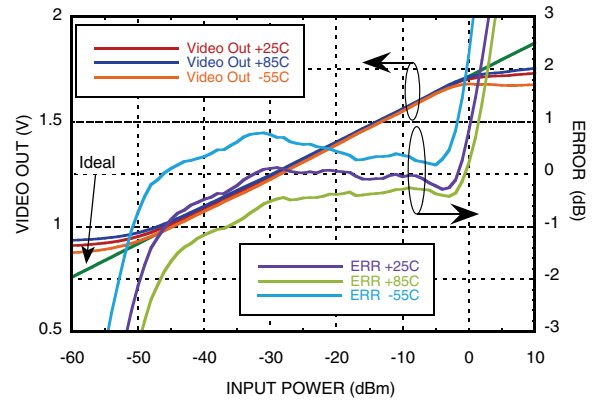

VIDEO OUT vs. Error vs. Input Power, F_{in} = 12 GHz

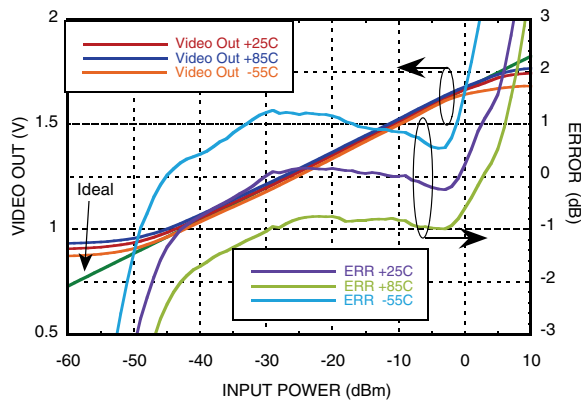

VIDEO OUT & Error vs. Input Power, F_{in} = 15 GHz

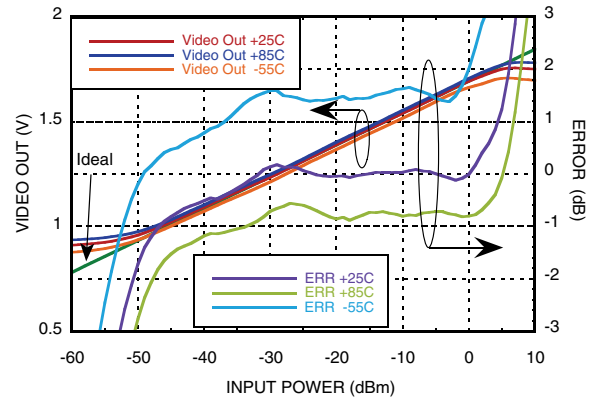

VIDEO OUT & Error vs. Input Power, F_{in} = 17 GHz

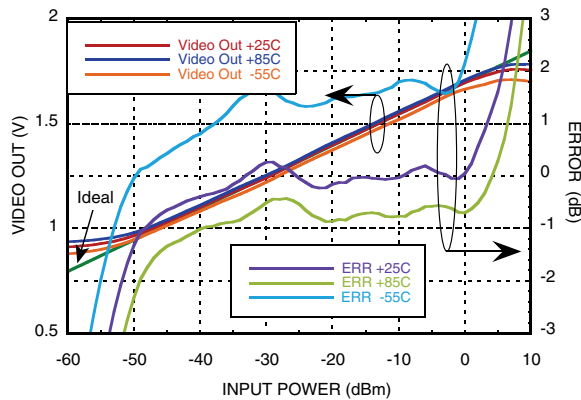

VIDEO OUT & Error vs. Input Power, F_{in} = 20 GHz

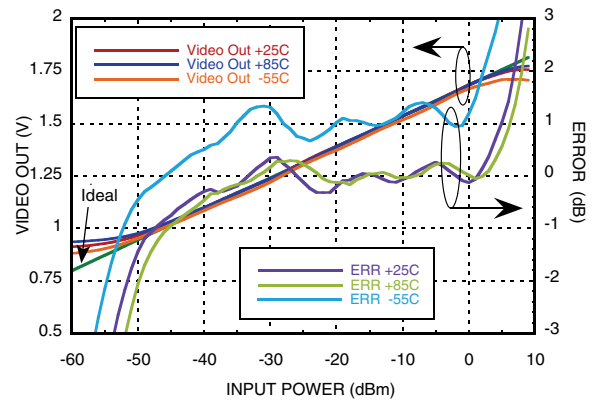

SUCCESSIVE DETECTION LOG VIDEO AMPLIFIER (SDLVA) 1 - 20 GHz

**VIDEO OUT vs. Frequency
Over Input Power & Temperature**

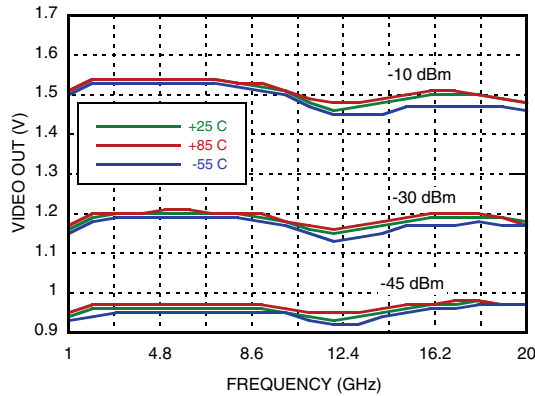

Input Return Loss vs. Frequency

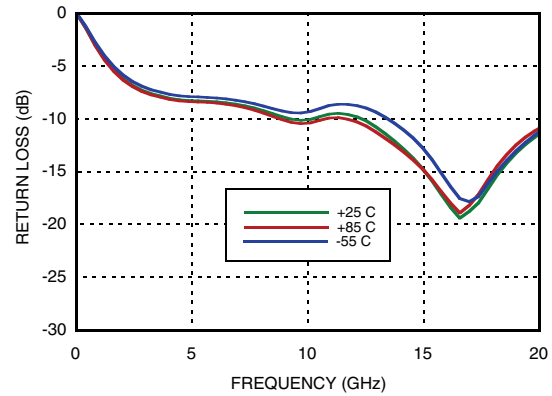

Rise Time @ 10 GHz @ -20 dBm

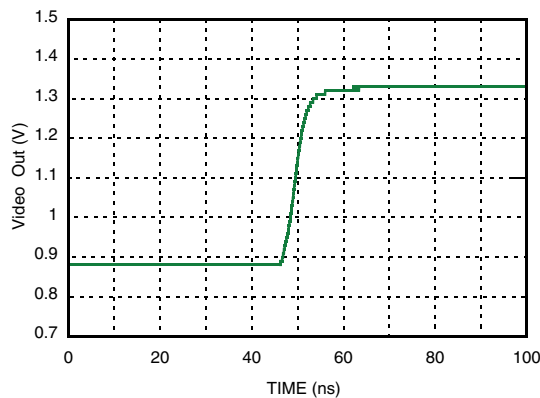

Fall Time @ 10 GHz @ -20 dBm

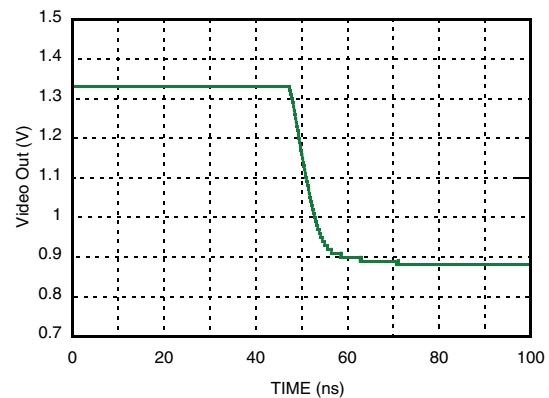

Absolute Maximum Ratings

I _{cc}	100 mA
Input Signal Amplitude	18 dBm
Junction Temperature	125 °C
Continuous P _{diss} (T=85°C) Derate 59 mW/°C above 85°C	1.6 W
Thermal Resistance (R _{th}) (junction to package bottom)	17 °C/W
V _{dc} Max	+16V
Storage Temperature	-65 to +150 °C
Operating Temperature	-55 to +85 °C
ESD Sensitivity (HBM)	Class 1A



**ELECTROSTATIC SENSITIVE DEVICE
OBSERVE HANDLING PRECAUTIONS**

**SUCCESSIVE DETECTION LOG VIDEO AMPLIFIER (SDLVA)
1 - 20 GHz**

Outline Drawing

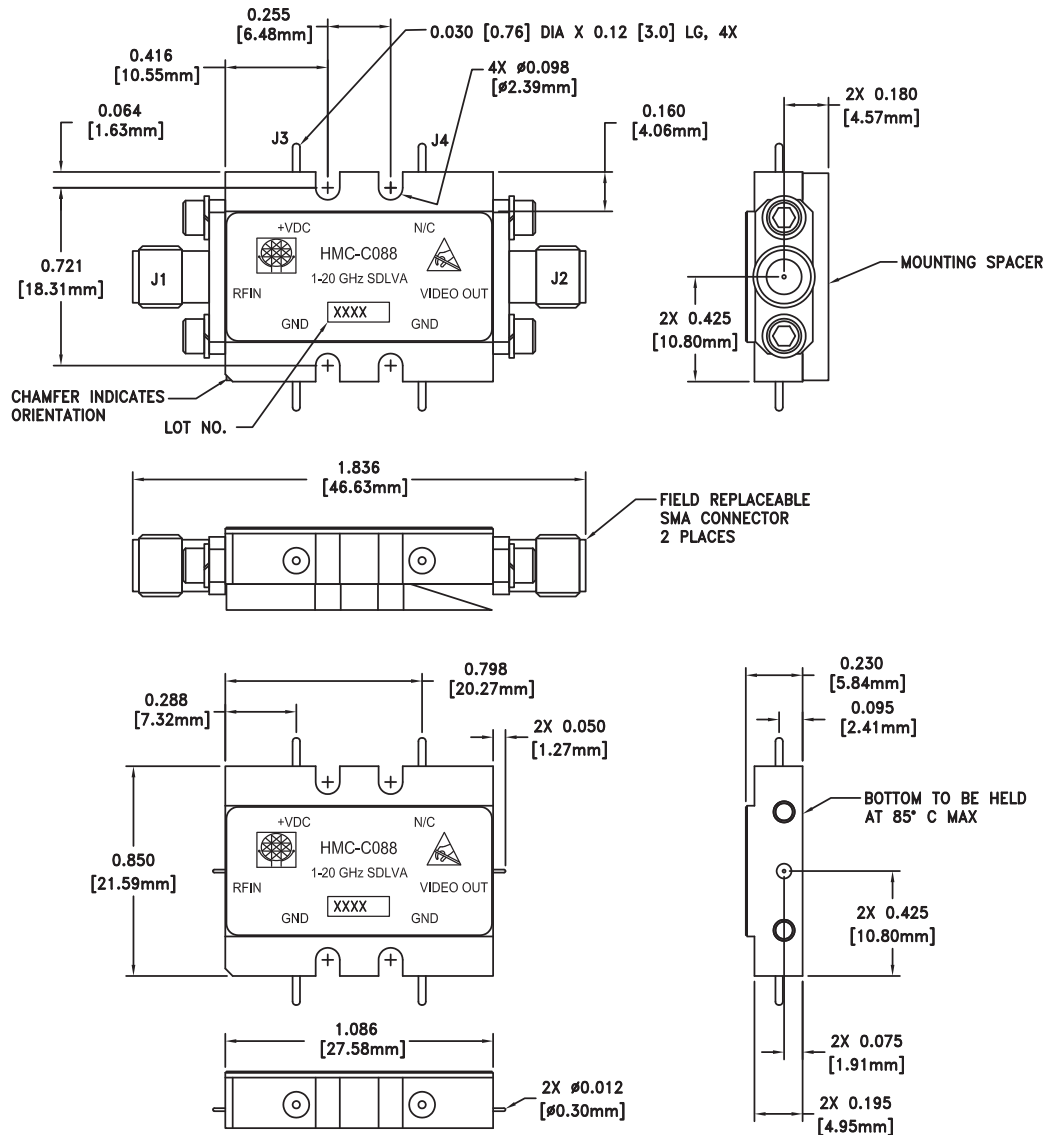

Package Information

Package Type	C-10
Package Weight [1]	16.7 gms [2]
Spacer Weight	3.3 gms [2]

[1] Includes the connectors

[2] ±1 gms Tolerance



NOTES:

NOTES:

1. PACKAGE, LEADS, COVER MATERIAL: KOVAR™
2. PLATING: GOLD PLATE OVER NICKEL PLATE.
3. MOUNTING SPACER: NICKEL PLATED ALUMINUM.
4. ALL DIMENSIONS ARE IN INCHES [MILLIMETERS].
5. TOLERANCES:
 - 5.1 .XX = ±.02
 - 5.2 .XXX = ±.010
6. MARK LOT NUMBER ON 0.080 X 0.250 LABEL WHERE SHOWN WITH .030" MIN TEXT HEIGHT.
7. MOUNTING SPACER PART NUMBER 126216.

SUCCESSIVE DETECTION LOG VIDEO AMPLIFIER (SDLVA) 1 - 20 GHz

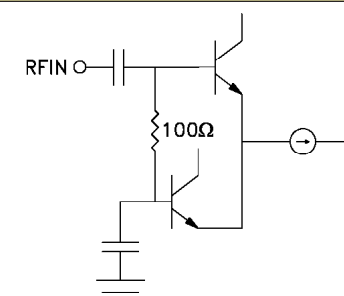
Pin Descriptions

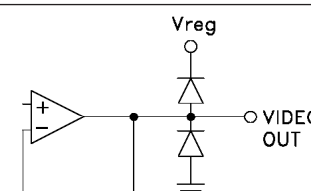
Pin Number	Function	Description	Interface Schematic
1	RFIN	RF Input pin.	
2, 3	GND	These pins must be connected to a high quality RF/DC ground.	
4	VIDEO OUT	Video Out is a voltage that is proportional to the log of the Input Power.	
5	N/C	The pins are not connected internally; however, all data shown herein was measured with these pins connected to RF/DC ground externally.	
6	Vdc	Bias Supply pin.	