

THIS COPY IS PROVIDED ON A RESTRICTED BASIS AND IS NOT TO BE USED IN ANY WAY DETRIMENTAL TO THE INTERESTS OF PANDUIT CORP.

NOTES:

1. DIMENSIONS IN [] ARE IN MILLIMETERS.



PANDUIT PART NO.	MATERIAL	FACE COLOR	PKG. QTY.	THICKNESS	PRODUCT TYPE
C300X250AOT	GMH3	BLACK	500	.030 +/- .010	POLYESTER/ FOAM COMPONENT LABEL
C300X250ABT		YELLOW			
C300X250AMT		SILVER			
C300X250APT	GMH3-W	WHITE			
C300X250AST	GMH3	GREEN			
C300X250AUT		ORANGE			
C300X250AWT		RED			

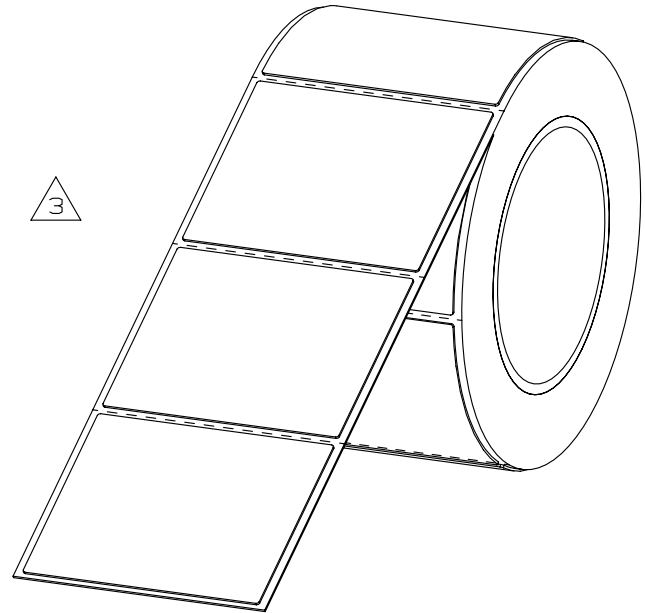
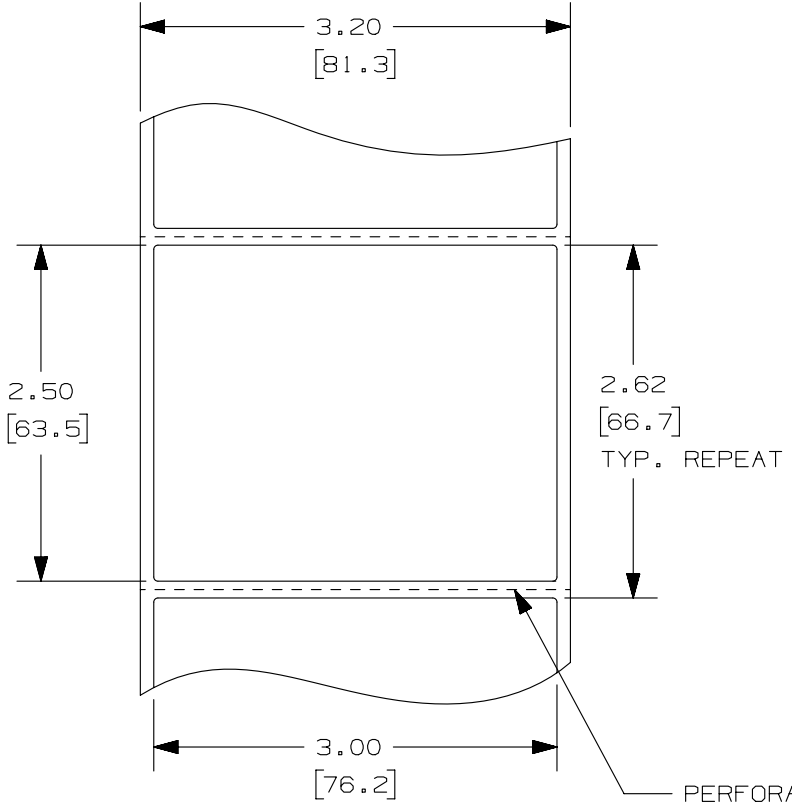

REV	DATE	BY	CHK	APR	DESCRIPTION	ECN
3	1/17/13	RVU	MSAD	SEWH	ADD material column and ISO view. Update part numbers sequence list.	GAECN00537
2	5/6/11	RVU	MSAD		TOL. SHOULD BE .12, .062, NOT .1, .050. ADD NEW PN: C300X250AUT.	6348
1	1/14/09	RVU	MSAD		ADDED "TYP REPEAT".	5592
0	9/5/08	RVU	DAPE	PTR	DRAWING RELEASE.	5537

TITLE RAISED PANEL COMPONENTS LABELS C300X250A*T CUSTOMER DRAWING					
ITEM REVISION NAME 100491BR/05			PANDUIT TM		
DATASET FILE NAME 100491BR-DC-C10731/05D					
UNLESS OTHERWISE SPECIFIED, DIMENSIONAL TOLERANCES ARE: IN [mm]					
.x ± .12 [3.04]		.xxx ± .025 [.635]		MATERIAL: SEE TABLE	
.xx ± .062 [1.57]		ANGLES ±		DRAWING NUMBER: C10731	
DRAWN BY RVU			DATE 9/5/08		CHK SCWE
SCALE NTS			SHT 1 OF 1		
SIZE A					

D10100DA/12