



M2764A

ADVANCED 64K (8K x 8) UV ERASABLE PROM

Military

- **Fast Access Time:**
 - M2764A-25 250 ns
 - M2764A-25 350 ns
- **HMOS* II-E Technology**
- **Low Power**
 - 100 mA Maximum Active
 - 40 mA Maximum Standby
- **Compatible with M2764, M27128A, M27256**
- **Intelligent Programming™ Algorithm**
 - Fastest EPROM Programming
- **Intelligent Identifier™ Mode**
 - Automated Programming Operations
- **Two Line Control**
- **± 10% V_{CC} Tolerance Available**
- **Military Temperature Range:**
 - 55°C to +125°C (T_C)

The Intel M2764A is a 5V only, 65,536-bit ultraviolet erasable and electrically programmable read-only memory (EPROM). The M2764A is an advanced version of the M2764 and is fabricated with Intel's HMOSII-E technology which significantly reduces die size and greatly improves the device's performance, power consumption, reliability and producibility.

Several advanced features have been designed into the M2764A that allow fast and reliable programming—the intelligent Programming Algorithm and the intelligent Identifier Mode. Programming equipment that takes advantage of these innovations will electronically identify the M2764A and then rapidly program it using an efficient programming method.

The M2764A also offers reduced power consumption compared to the M2764. The maximum active current is 100 mA while the maximum standby current is only 40 mA. The standby mode lowers power consumption without increasing access time.

Two-line control and JEDEC-approved, 28 pin packaging are standard features of all Intel higher density EPROMs. This ensures easy microprocessor interfacing and minimum design efforts when upgrading, adding or choosing between non-volatile memory alternatives.

*HMOS is a patented process of Intel Corporation.

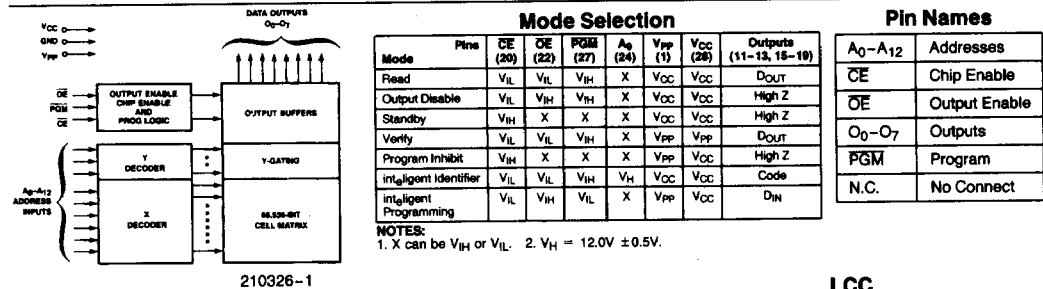

Figure 1. Block Diagram

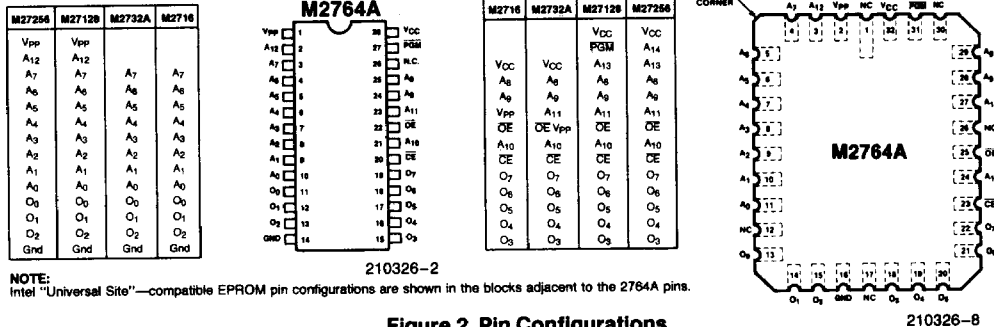

Figure 2. Pin Configurations

NOTE: Intel "Universal Site"—compatible EPROM pin configurations are shown in the blocks adjacent to the 2764A pins.

ABSOLUTE MAXIMUM RATINGS*

Case Temperature Under Bias . . . -55°C to +125°C
 Storage Temperature -65°C to +150°C
 All Input or Output Voltages with
 Respect to Ground +6.25V to -0.6V
 Voltage on Pin 24 with
 Respect to Ground +13.5V to -0.6V
 V_{PP} Supply Voltage with Respect to
 Ground During Programming +13V to -0.6V

NOTICE: This is a production data sheet. The specifications are subject to change without notice.

**WARNING: Stressing the device beyond the "Absolute Maximum Ratings" may cause permanent damage. These are stress ratings only. Operation beyond the "Operating Conditions" is not recommended and extended exposure beyond the "Operating Conditions" may affect device reliability.*

D.C. AND A.C. OPERATING CONDITIONS DURING READ

| Symbol | Parameter | Min | Max | Units |
|-----------------|-------------------------------|------|------|-------|
| T _C | Case Temperature (Instant On) | -55 | +125 | °C |
| V _{CC} | Digital Supply Voltage | 4.50 | 5.50 | V |

READ OPERATION
D.C. CHARACTERISTICS (Over Specified Operating Conditions)

| Symbol | Parameter | Limits | | | | Comments |
|---------------------------------|---------------------------------|--------|--------------------|---------------------|-------|--|
| | | Min | Typ ⁽³⁾ | Max | Units | |
| I _{LI} | Input Load Current | | | 10 | μA | V _{IN} = 5.5V |
| I _{LO} | Output Leakage Current | | | 10 | μA | V _{OUT} = 5.5V |
| I _{PP1} ⁽²⁾ | V _{PP} Current Read | | | 5 | mA | V _{PP} = 5.5V |
| I _{CC1} ⁽²⁾ | V _{CC} Current Standby | | | 40 | mA | $\overline{CE} = V_{IH}$ |
| I _{CC2} ⁽²⁾ | V _{CC} Current Active | | 45 | 100 | mA | $\overline{CE} = \overline{OE} = V_{IL}$ |
| V _{IL} | Input Low Voltage | -0.1 | | +0.8 | V | |
| V _{IH} | Input High Voltage | 2.0 | | V _{CC} + 1 | V | |
| V _{OL} | Output Low Voltage | | | 0.45 | V | I _{OL} = 2.1 mA |
| V _{OH} | Output High Voltage | 2.4 | | | V | I _{OH} = -400 μA |

A.C. CHARACTERISTICS

| Symbol | Parameter | M2764A-25 | | M2764A-35 | | Units | Comments |
|--------------------------------|--|-----------|-----|-----------|-----|-------|--|
| | | Min | Max | Min | Max | | |
| t _{ACC} | Address to Output Delay | | 250 | | 350 | ns | $\overline{CE} = \overline{OE} = V_{IL}$ |
| t _{CE} | \overline{CE} to Output Delay | | 250 | | 350 | ns | $\overline{OE} = V_{IL}$ |
| t _{OE} | \overline{OE} to Output Delay | | 100 | | 120 | ns | $\overline{CE} = V_{IL}$ |
| t _{DF} ⁽⁴⁾ | \overline{OE} High to Output Float | 0 | 55 | 0 | 105 | ns | $\overline{CE} = V_{IL}$ |
| t _{OH} ⁽⁴⁾ | Output Hold from Addresses \overline{CE} or \overline{OE} Whichever Occurred First | 0 | | 0 | | ns | $\overline{CE} = \overline{OE} = V_{IL}$ |

NOTES:

- V_{CC} must be applied simultaneously or before V_{PP} and removed simultaneously or after V_{PP}.
- V_{PP} may be connected directly to V_{CC} except during programming. The supply current would then be the sum of I_{CC} and I_{PP1}.
- Typical values are for t_C = +25°C and nominal supply voltages.
- Output Float is defined as the point where data is no longer driven—see timing diagram on page 3.

CAPACITANCE $T_C = 25^\circ\text{C}, f = 1\text{MHz}$

| Symbol | Parameter | Typ(1) | Max | Units | Conditions |
|-----------|--------------------|--------|-----|-------|----------------|
| C_{IN} | Input Capacitance | 4 | 6 | pF | $V_{IN} = 0V$ |
| C_{OUT} | Output Capacitance | 8 | 12 | pF | $V_{OUT} = 0V$ |

A.C. TESTING INPUT, OUTPUT WAVEFORM

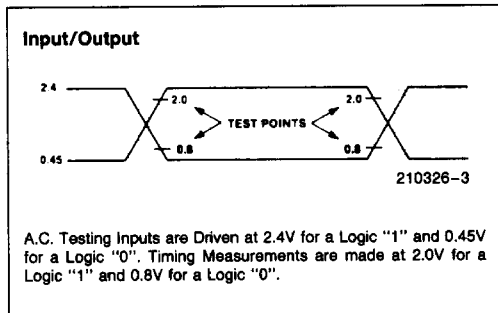

A.C. TESTING LOAD CIRCUIT

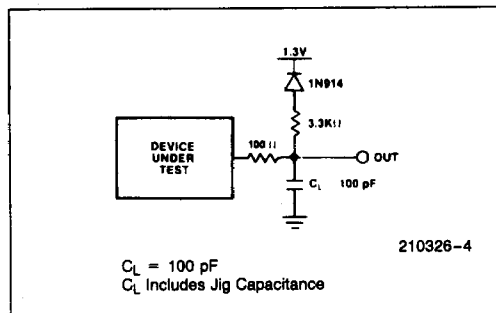

A.C. WAVEFORMS

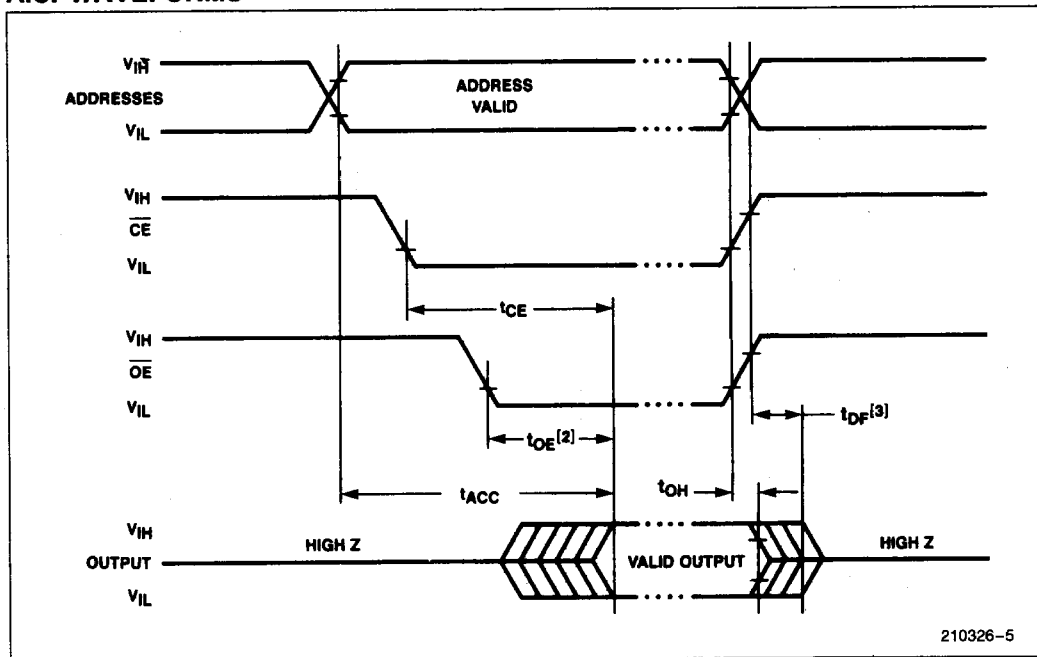

NOTES:

1. Typical values are for $T_C = +25^\circ\text{C}$ and nominal supply voltages.
2. \overline{OE} may be delayed up to $t_{ACC} - t_{OE}$ after the falling edge of \overline{CE} without impact on t_{ACC} .
3. Output float is defined as the point where data is no longer driven.

DEVICE OPERATION

The seven modes of operation of the M2764A are listed in Table 1. A single 5V power supply is required in the read mode. All inputs are TTL levels except for V_{PP} and 12V on A9 for intelligent identifier mode.

Table 1. Mode Selection

| Mode | Pins | | PGM | Ag | Vpp | VCC | Outputs |
|-------------------------|-----------------|-----------------|-----------------|----------------|-----------------|-----------------|------------------|
| | CE (20) | OE (22) | (27) | (24) | (1) | (28) | (11-13, 15-19) |
| Read | V _{IL} | V _{IL} | V _{IH} | X | V _{CC} | V _{CC} | D _{OUT} |
| Output Disable | V _{IL} | V _{IH} | V _{IH} | X | V _{CC} | V _{CC} | High Z |
| Standby | V _{IH} | X | X | X | V _{CC} | V _{CC} | High Z |
| Verify | V _{IL} | V _{IL} | V _{IH} | X | V _{PP} | V _{CC} | D _{OUT} |
| Program Inhibit | V _{IH} | X | X | X | V _{PP} | V _{CC} | High Z |
| intelligent identifier | V _{IL} | V _{IL} | V _{IH} | V _H | V _{CC} | V _{CC} | Code |
| intelligent Programming | V _{IL} | V _{IH} | V _{IL} | X | V _{PP} | V _{CC} | D _{IN} |

NOTES:

1. X can be V_{IH} or V_{IL}.
2. V_H = 12.0V - 0.5V.

READ MODE

The M2764A has two control functions, both of which must be logically active in order to obtain data at the outputs. Chip Enable (CE) is the power control and should be used for device selection. Output Enable (OE) is the output control and should be used to gate data from the output pins, independent of device selection. Assuming that addresses are stable, the address access time (t_{ACC}) is equal to the delay from CE to output (t_{CE}). Data is available at the outputs after a delay of t_{OE} from the falling edge of OE, assuming that CE has been low and addresses have been stable for at least t_{ACC}-t_{OE}.

STANDBY MODE

The M2764A has standby mode which reduces the maximum current from 100 mA to 40 mA. The M2764A is placed in the standby mode by applying a TTL-high signal to the CE input. When in standby mode, the outputs are in a high impedance state, independent of the OE input.

Output OR-Tieing

Because EPROMs are usually used in larger memory arrays, Intel has provided 2 control lines which accommodate this multiple memory connection. The two control lines allow for:

- a) the lowest possible memory power dissipation, and

- b) Complete assurance that output bus contention will not occur.

To use these two control lines most efficiently, CE (pin 20) should be decoded and used as the primary device selecting function, while OE (pin 22) should be made a common connection to all devices in the array and connected to the READ line from the system control bus. This assures that all deselected memory devices are in their low power standby mode and that the output pins are active only when data is desired from a particular memory device.

System Considerations

The power switching characteristics of HMOSII-E EPROMs require careful decoupling of the devices. The supply current, I_{CC}, has three segments that are of interest to the system designer—the standby current level, the active current level, and the transient current peaks that are produced by the falling and rising edges of Chip Enable. The magnitude of these transient current peaks is dependent on the output capacitive loading of the device. The associated transient voltage peaks can be suppressed by complying with Intel's Two-Line Control, as detailed in Intel's Application Note AP-72, Order Number 8566, and by properly selected decoupling capacitors. It is recommended that a 0.1 μF ceramic capacitor be used on every device between V_{CC} and GND. This should be a high frequency capacitor of low inherent inductance and should be placed as close to the device as possible. In addition, a 4.7 μF bulk electrolytic capacitor should be used between V_{CC} and GND for every eight devices. The bulk capacitor should be located near where the power supply is connected to the array. The purpose of the bulk capacitor is to overcome the voltage droop caused by the inductive effect of PC board-traces.

PROGRAMMING MODES

Caution: Exceeding 13V on pin 1 (V_{PP}) will permanently damage the M2764A.

Initially, and after each erasure, all bits of the M2764A are in the "1" state. Data is introduced by selectively programming "0s" into the desired bit locations. Although only "0s" will be programmed, both "1s" and "0s" can be present in the data word. The only way to change a "0" to a "1" is by ultraviolet light erasure.

The M2764A is in the programming mode when V_{PP} input is at 12.5V and CE and PGM are both TTL low. The data to be programmed is applied 8 bits in parallel to the data output pins. The levels required for the address and data inputs are TTL.

intelligent Programming™ Algorithm

The M2764A intelligent Programming Algorithm rapidly programs Intel M2764A EPROMs using an efficient and reliable method particularly suited to the production programming environment. Typical programming time for individual devices is on the order of one and a half minutes. Programming reliability is also ensured as the incremental program margin of each byte is continually monitored to determine when it has been successfully programmed. A flow-chart of the M2764A intelligent Programming Algorithm is shown in Figure 3.

The intelligent Programming Algorithm utilizes two different pulse types: initial and overprogram. The duration of the initial \overline{CE} pulse(s) is one millisecond, which will then be followed by a longer overprogram pulse of length $3X$ ms X is an iteration counter and is equal to the number of the initial one millisecond pulses applied to a particular M2764A location, before a correct verify occurs. Up to 25 one-millisecond pulses per byte are provided for before the overprogram pulse is applied.

The entire sequence of program pulses and byte verifications is performed at $V_{CC} = 6.0V$ and $V_{PP} = 12.5V$. When the intelligent Programming cycle has been completed, all bytes should be compared to the original data with $V_{CC} = V_{PP} = 5.0V$.

Program Inhibit

Programming of multiple M2764As in parallel with different data is easily accomplished by using the Program Inhibit mode. A high-level \overline{CE} or \overline{PGM} input inhibits the other M2764As from being programmed.

Except for \overline{CE} , all like inputs (including \overline{OE}) of the parallel M2764As may be common. A TTL low-level pulse applied to the \overline{CE} input with V_{PP} at 12.5V will program the selected M2764A.

Verify

A verify should be performed on the programmed bits to determine that they have been correctly programmed. The verify is performed with \overline{OE} at V_{IL} , \overline{CE} at V_{IL} , \overline{PGM} at V_{IH} and V_{PP} at 12.5V.

intelligent Identifier™ Mode

The intelligent Identifier Mode allows the reading out of a binary code from an EPROM that will identify its manufacturer and type. This mode is intended for use by programming equipment for the purpose of automatically matching the device to be programmed with its corresponding programming algorithm. This mode is functional in the $25^{\circ}C \pm 5^{\circ}C$ ambient temperature range that is required when programming the M2764A.

To activate this mode, the programming equipment must force 11.5V to 12.5V on address line A9 (pin 24) of the M2764A. Two identifier bytes may then be sequenced from the device outputs by toggling address line A0 (pin 10) from V_{IL} to V_{IH} . All other address lines must be held at V_{IL} during intelligent Identifier Mode.

Byte 0 ($A0 = V_{IL}$) represents the manufacturer code and byte 1 ($A0 = V_{IH}$) the device identifier code. For the Intel M2764A, these two identifier bytes are given in Table 2. All identifiers for manufacturer and device codes will possess odd parity, with the MSB (0-7) defined as the parity bit.

Table 2. M2764A intelligent Identifier™ Bytes

| Identifier | Pins | A ₀ (10) | O ₇ (19) | O ₆ (18) | O ₅ (17) | O ₄ (16) | O ₃ (15) | O ₂ (13) | O ₁ (12) | O ₀ (11) | Hex Data |
|-------------------|------|------------------------|------------------------|------------------------|------------------------|------------------------|------------------------|------------------------|------------------------|------------------------|-------------|
| Manufacturer Code | | V_{IL} | 1 | 0 | 0 | 0 | 1 | 0 | 0 | 1 | 89 |
| Device Code | | V_{IH} | 0 | 0 | 0 | 0 | 1 | 0 | 0 | 0 | 08 |

NOTES:

1. $A_9 = 2.0V \pm 0.5V$
2. $A_1-A_6, A_{10}-A_{13}, \overline{CE}, \overline{OE} = V_{IL}$
3. $A_{14} = V_{IH}$ or V_{IL}

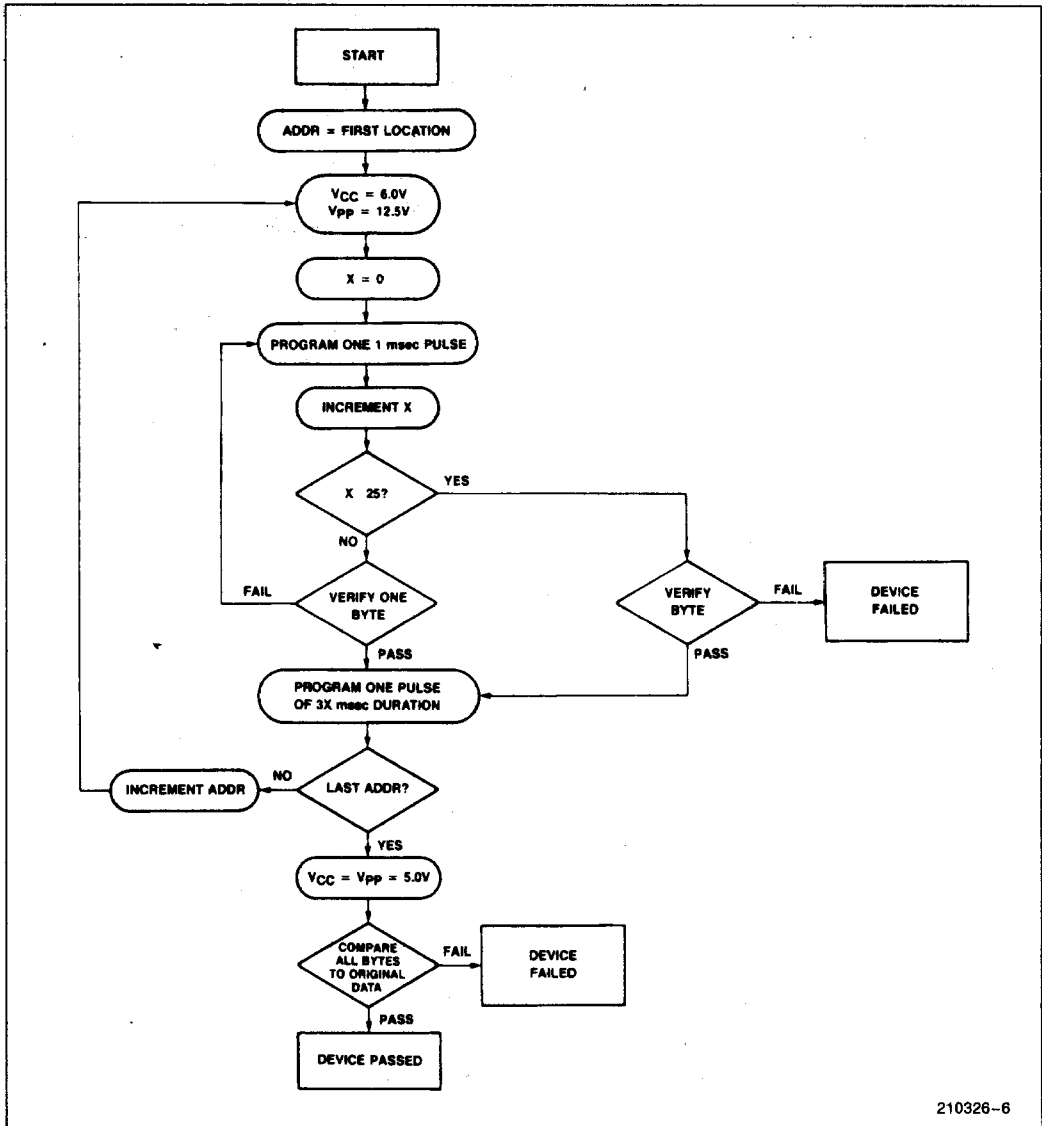

Figure 3. M2764A Intelligent Programming™ Flowchart

7

ERASURE CHARACTERISTICS

The erasure characteristics of the M2764A are such that erasure begins to occur upon exposure to light with wavelengths shorter than approximately 4000 Angstroms (Å). It should be noted that sunlight and certain types of fluorescent lamps have wavelengths in the 3000–4000Å range. Data show that constant exposure to room level fluorescent lighting could erase that typical M2764A in approximately 3 years, while it would take approximately 1 week to cause erasure when exposed to direct sunlight. If the M2764A is to be exposed to these types of lighting conditions for extended periods of time, opaque labels should be placed over the M2764A window to prevent unintentional erasure.

The recommended erasure procedure for the M2764A is exposure to shortwave ultraviolet light

which has a wavelength of 2537 Angstroms (Å). The integrated dose (i.e., UV intensity x exposure time) for erasure should be a minimum of 15 Wsec/cm². The erasure time with this dosage is approximately 15 to 20 minutes using an ultraviolet lamp with a 12000 μW/cm² power rating. The M2764A should be placed within 1 inch of the lamp tubes during erasure. The maximum integrated dose a M2764A can be exposed to without damage is 7258 Wsec/cm² (1 week @ 12000 μW/cm²). Exposure of the M2764A to high intensity UV light for long periods may cause permanent damage.

RELEVANT INTEL LITERATURE

AR-265 Versatile Algorithm, Equipment Cut Programming Time

RR-35B EPROM Reliability Data Summary

Intelligent Programming™ Algorithm

D.C. PROGRAMMING CHARACTERISTICS

$T_C = 25 \pm 5^\circ C$, $V_{CC} = 6.0V \pm 0.25V$, $V_{PP} = 12.5V \pm 0.3V$

| Symbol | Parameter | Limits | | | Comments (Note 1) |
|-----------|--|--------|--------------|-----|-------------------------------|
| | | Min | Max | Min | |
| I_{LI} | Input Current (All Inputs) | | 10 | μA | $V_{IN} = V_{IL}$ or V_{IH} |
| V_{IL} | Input Low Level (All Inputs) | - 0.1 | 0.8 | V | |
| V_{IH} | Input High Level | 2.0 | $V_{CC} + 1$ | V | |
| V_{OL} | Output Low Voltage During Verify | | 0.45 | V | $I_{OL} = 2.1$ mA |
| V_{OH} | Output High Voltage During Verify | 2.4 | | V | $I_{OH} = -400$ μA |
| I_{CC2} | V_{CC} Supply Current (Program & Verify) | | 75 | mA | |
| I_{PP2} | V_{PP} Supply Current (Program) | | 50 | mA | $\overline{CE} = V_{IL}$ |
| V_{ID} | A_9 intelligent Identifier Voltage | 11.5 | 12.5 | V | |

NOTE:

- V_{CC} must be applied simultaneously or before V_{PP} and removed simultaneously or after V_{PP} .

A.C. PROGRAMMING CHARACTERISTICS

$T_C = 25 \pm 5^\circ\text{C}$, $V_{CC} = 6.0\text{V} \pm 0.25\text{V}$, $V_{PP} = 12.5\text{V} \pm 0.3\text{V}$

| Symbol | Parameter | Limits | | | | Comments (Note 1) |
|-----------------|--|--------|-----|-------|---------------|-------------------|
| | | Min | Typ | Max | Unit | |
| t_{AS} | Address Setup Time | 2 | | | μs | |
| t_{OES} | \overline{OE} Setup Time | 2 | | | μs | |
| t_{DS} | Data Setup Time | 2 | | | μs | |
| t_{AH} | Address Hold Time | 0 | | | μs | |
| t_{DH} | Data Hold Time | 2 | | | μs | |
| $t_{DFP}^{(4)}$ | Output Enable to Output Float Delay | 0 | | 130 | ns | |
| t_{VPS} | V_{PP} Setup Time | 2 | | | μs | |
| t_{VCS} | V_{CC} Setup Time | 2 | | | μs | |
| t_{CES} | \overline{CE} Setup Time | 2 | | | μs | |
| t_{PW} | \overline{PGM} Initial Program Pulse Width | 0.95 | 1.0 | 1.05 | ms | (Note 3) |
| t_{OPW} | \overline{PGM} Overprogram Pulse Width | 2.85 | | 78.75 | ms | (Note 2) |
| t_{OE} | Data Valid from \overline{OE} | | | 150 | ns | |

A.C. CONDITIONS OF TEST

Input Rise and Fall Times (10% to 90%) 20 ns
 Input Pulse Levels 0.45V to 2.4V
 Input Timing Reference Level 0.8V and 2.0V
 Output Timing Reference Level 0.8V and 2.0V

NOTES:

1. V_{CC} must be applied simultaneously or before V_{PP} and removed simultaneously or after V_{PP} .
2. The length of the overprogram pulse may vary from 2.85 ms to 78.75 ms as a function of the iteration counter value X.
3. Initial Program Pulse width tolerance is 1 ms \pm 5%.
4. Output Float is defined as the point where data is no longer driven—see timing diagram on page 9.

intelligent Programming™ WAVEFORMS

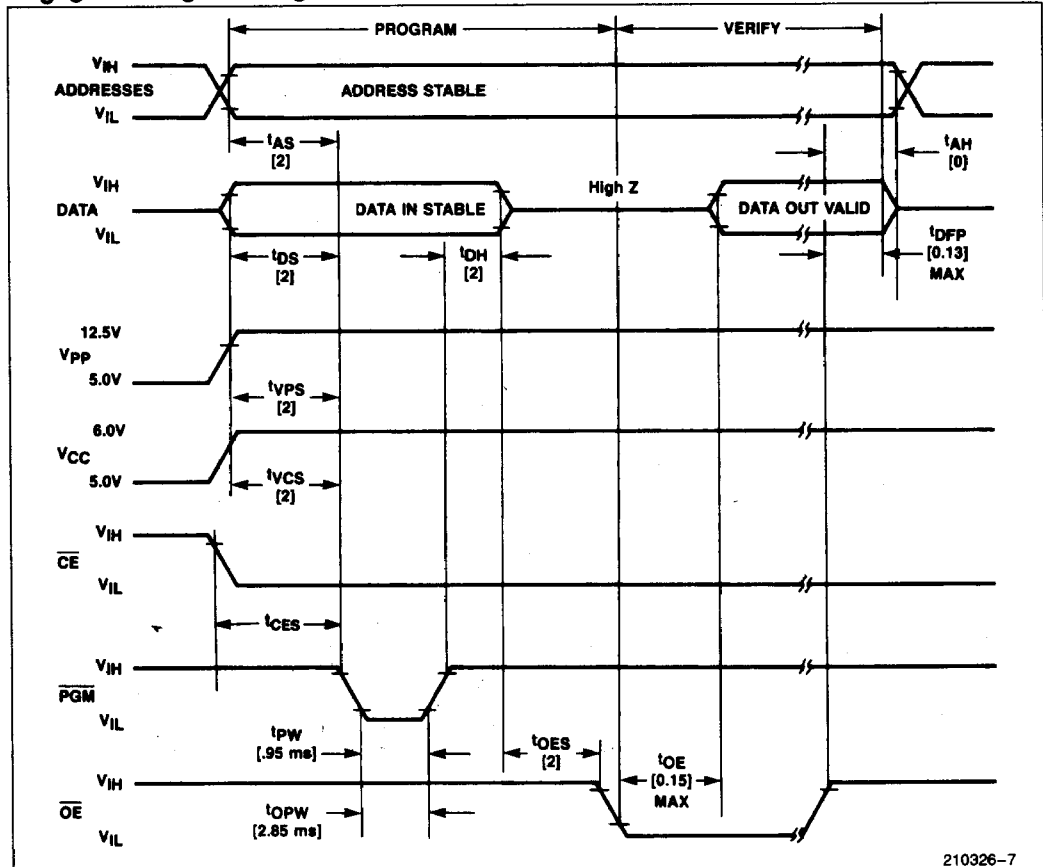

210326-7

NOTES:

1. All times show in [] are minimum and in μ s unless otherwise specified.
2. The input timing reference level is 0.8V for V_{IL} and 2V for a V_{IH} .
3. t_{OE} and t_{DPP} are characteristics of the device but must be accommodated by the programmer.
4. When programming the M2764A, a 0.1 μ F capacitor is required across V_{PP} and ground to suppress spurious voltage transients which can damage the device.