

**Rotary Switches, 500m Amp, Adjustable Stop, 36° Throw**

**MATERIAL SPECIFICATIONS:**

Contacts .....Silver  
 Case Material .....Aluminum  
 Actuator Material .....Brass  
 Terminals/Fixed Contacts.....Silver plated brass  
 Terminal Seal .....Insert molded, DAP bas

**ENVIRONMENTAL SPECIFICATIONS:**

Operating Temperature.....-4°F to +176°F (-20°C to +80°C)  
 Storage Temperature .....-4°F to +212°F (-20°C to +100°C)  
 Solder Heat Resistance.....Manual: 270°C for 3 seconds  
 Wave: 245°C for 3 seconds

**TYPICAL PERFORMANCE CHARACTERISTICS:**

Contact Rating .....500 Milliamps @ 125 VAC or  
 28 VDC resistive  
 Initial Contact Resistance.....50 Milliohms max.  
 Contact Timing.....Non-shorting  
 Insulation Resistance .....100 Megohms min.  
 Dielectric Strength .....1,000 Volts RMS @ sea level  
 Rotation Torque .....14 Inch ounce max.  
 High Torque Bushing Shoulder ....Nickle plated brass  
 Plunger/Actuator Travel.....36°  
 Life Expectancy .....Up to 10,000 Cycles @ full contact  
 rating  
 Up to 25,000 Cycles @ 150 mA @  
 125 VAC or 250 mA @ 28 VDC

**NOTICE: Set stop positions by presetting external pin plate provided.**

4 Pole, 2 Positions

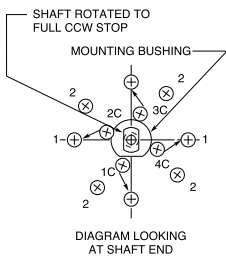

3 Pole, 2-3 Positions, Adjustable

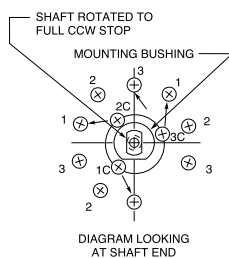

2 Pole, 2-5 Positions, Adjustable

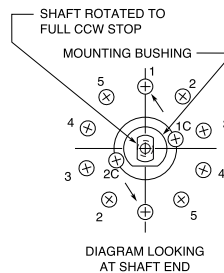

1 Pole, 2-10 Positions, Adjustable

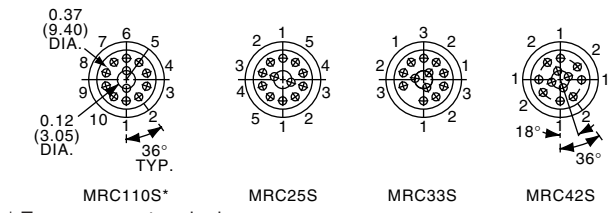
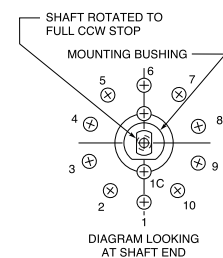

\* Two common terminals are internally shorted. Use either one.

36° ANGLE OF THROW

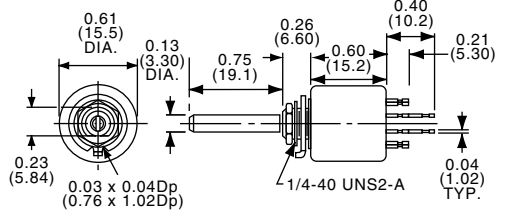

MRC33S

Part Number		No. Poles	Adjustable Positions
Tyco Electronics	Alcoswitch		
1437629-2	MRC110S	1 Pole	2 to 10 Positions
1437629-4	MRC25S	2 Poles	2 to 5 Positions
1437629-6	MRC33S	3 Poles	2 to 3 Positions
1437629-8	MRC42S	4 Poles	2 Positions (fixed)

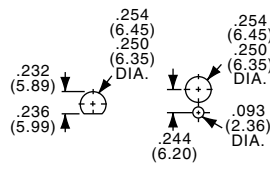

36° ANGLE OF THROW

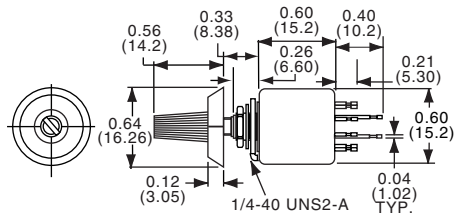

KNOB NOT SOLD SEPARATELY

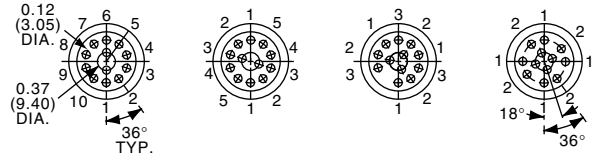

MRC25

Part Number		No. Poles	Adjustable Positions
Tyco Electronics	Alcoswitch		
1437629-1	MRC110	1 Pole	2 to 10 Positions
1437629-3	MRC25	2 Poles	2 to 5 Positions
1437629-5	MRC33	3 Poles	2 to 3 Positions
1437629-7	MRC42	4 Poles	2 Positions (fixed)

\* Two common terminals are internally shorted. Use either one.



**Rotary Switches, 6000 Series**

Alcoswitch 6000 Series Rotary Switches are used in programming electrical and mechanical circuits in machine tools, test equipment, and input data terminals. These manually operated switches are specifically designed to be mounted on a pc board and offer output capabilities which include: 8-position binary-coded octal (BC), 10-position binary-coded decimal (BCD), 16-position hexadecimal plus 10- and 16-position single pole decimal. All switches feature a small diameter and very low profile.

In addition to varied output capabilities, these versatile Alcoswitch switches can also be supplied in three different styles, allowing you to select the operation method best suited to your specific application. One version incorporates a slot which accepts a screwdriver, coin or other similar device. This particular style permits operation of the switch without sacrificing overall height. Its height of .220 [5.59] above the pc board is no greater than the usual board-mounted discrete components. The other two versions have either a bar-type knob or thumbwheel for their operation. All three styles can be rotated bidirectionally.

Rugged construction, positive detent action contacts plus large, readable characters are additional features of the Alcoswitch 6000 Series PC Board Rotary Switches. All these features, coupled with a fully enclosed design for better environmental protection, provide excellent electrical and mechanical performance.

**PERFORMANCE CHARACTERISTICS**

- Current/Voltage Rating**— Signal application only.
- Dielectric Breakdown Voltage**— 500 VDC min.
- Insulation Resistance**— 1 x 10<sup>8</sup> ohms
- Initial Contact Resistance**— 25 milliohms (at 50 millivolts, 100 milliamperes) closed circuit
- Circuit Capacitance**— 5 picofarads (at 100 KHz)
- Durability**— 1000 cycles
- Operating Torque**— 2 - 12 inch-ounces initial and after durability
- Temperature Rating**—
- Operating** — -18°C to +88°C
- Storage** — -45°C to +88°C
- Humidity**— Withstands an environment of +40°C and 95% RH for 96 hours

**MATERIALS**

- Contacts**— Phosphor bronze, gold over nickel plated
- Solder Tabs and Pins**—
- Coded Switches** — Beryllium copper, tin plated
- Single Pole Switches** — Brass, tin plated
- Structural Parts** — Thermoplastic

Technical Documents

- Product Specification**— 108-7514
- Instruction Sheet**— 408-07523
- Application Specification**— 114-7005

**Product Facts**

- n **Compact design** — small diameter, low profile switches are ideal for pc board mounting
- n **Wide choice of outputs:** 8-position binary-coded octal, 10-position binary-coded decimal, 16-position hexadecimal and 10- and 16-position single pole
- n **Versatile application** — styles include slotted, bar-type and thumbwheel versions for hand rotation
- n **Positive switching** — contacts have positive detent action
- n **All positions are easily identified** by large readable characters or dots
- n **Optimum reliability** — fully enclosed design protects contacts against contamination

**Rotary Switches, PC Mount, 8 or 10 Positions**

Switch Position	Common to:		
	1	2	3
0			
1	•		
2		•	
3	•	•	
4			•
5	•		•
6		•	•
7	•	•	•



Screwdriver/Coin Actuated  
Part No. 435174-1

**8-POSITION  
BINARY CODED OCTAL (BCO)**

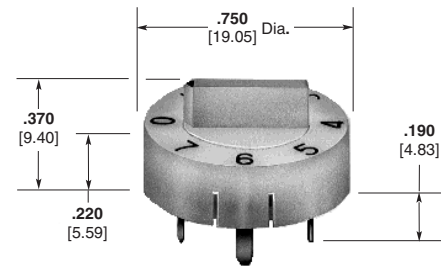

Bar-Type Knob  
Part No. 1- 435174-1 (Shown)

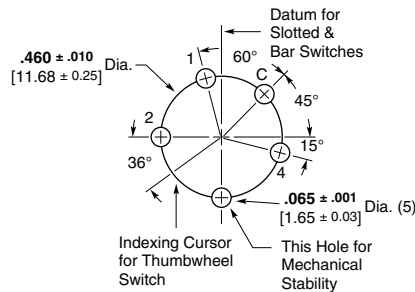

Recommended PC Board Hole Pattern  
(Switch Side)

Switch Position	Common to:			
	1	2	4	8
0				
1	•			
2		•		
3	•	•		
4			•	
5	•		•	
6		•	•	
7	•	•	•	
8				•
9	•			•

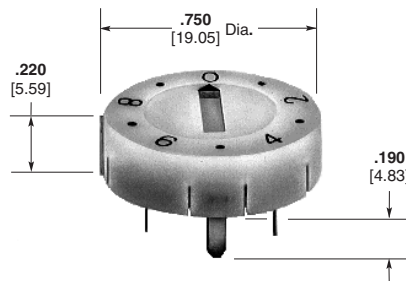

Screwdriver/Coin Actuated  
Part No. 435005-1

**10-POSITION  
BINARY CODED DECIMAL (BCD)**

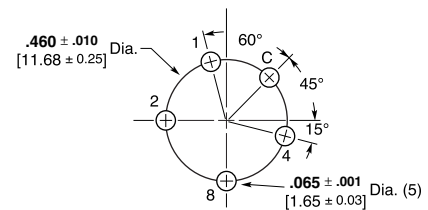

Recommended PC Board Hole Pattern  
(Switch Side)

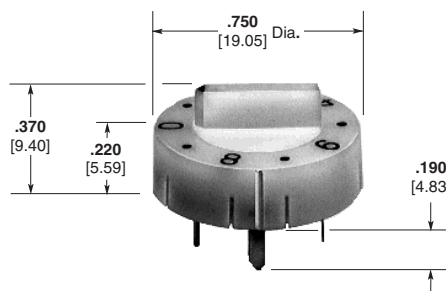

Bar-Type Knob  
Part No. 435123-1

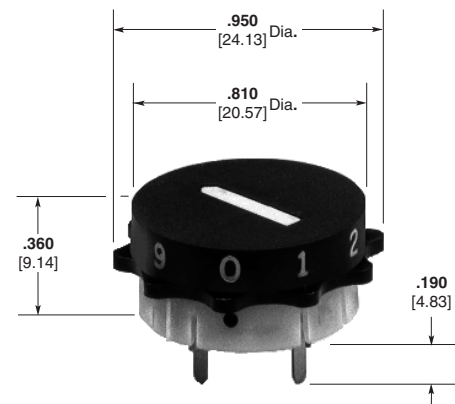

Thumbwheel  
Part No. 435128-1

G

6000 Series

**Rotary Switches, PC Mount, 10 or 16 Position**

**10-POSITION SINGLE POLE**

Switch Position	Common to:
	0 1 2 3 4 5 6 7 8 9
0	•
1	•
2	•
3	•
4	•
5	•
6	•
7	•
8	•
9	•

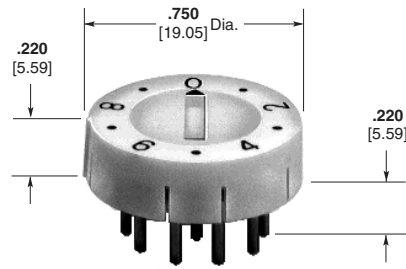

Screwdriver/Coin Actuated  
Part No. 1-435097-1

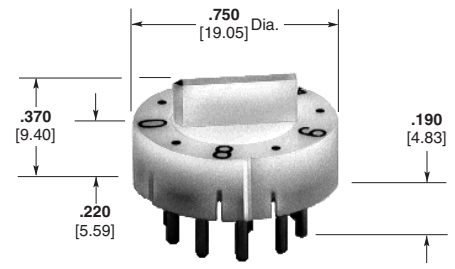

Bar-Type Knob  
Part No. 2-435097-1

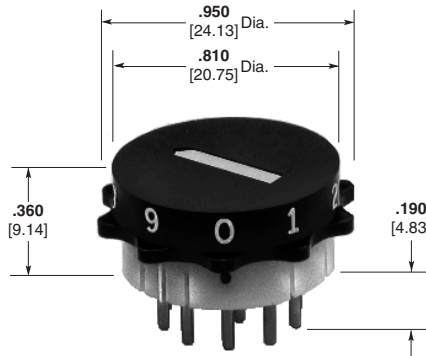

Thumbwheel  
Part No. 435097-1 (Shown)  
Part No. 435097-2 (With Numbers 1 - 10)

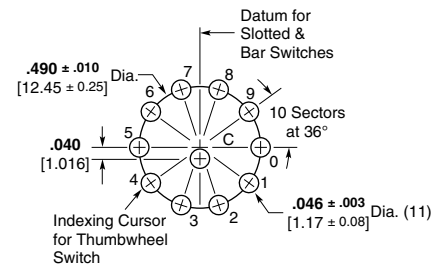

Recommended PC Board Hole Pattern  
(Switch Side)

**16-POSITION HEXADECIMAL**

Switch Position	Common to:
	1 2 4 8
0	
1	•
2	•
3	•
4	•
5	•
6	•
7	•
8	•
9	•
10	•
11	•
12	•
13	•
14	•
15	•

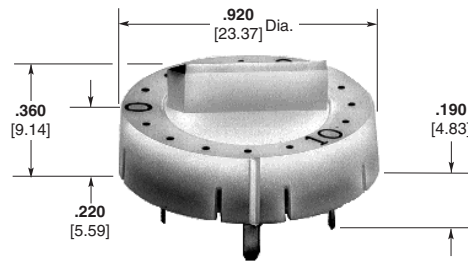

Bar-Type Knob  
Part No. 1-435167-1

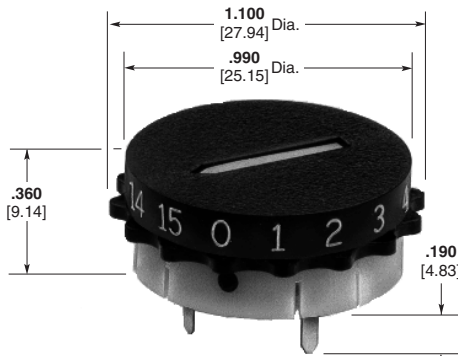

Thumbwheel  
Part No. 2-435167-1 (Shown)

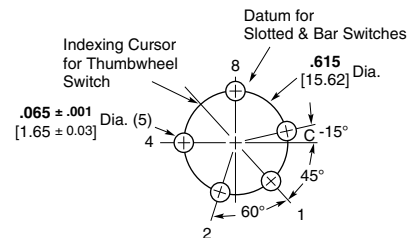

Recommended PC Board Hole Pattern  
(Switch Side)

G

6000 Series



**3100 Series Rotary Switches**

Alcoswitch Rotary Switches provide a highly reliable means of manually programming various types of electronic equipment. They are specifically designed for logic level circuitry, but are capable of controlling electrical circuits that operate at current ratings of 2 amperes, 115 VAC (nonswitching) and up to 125 milliamperes, 115 VAC (switching).

Positive detent action, with a quick make/break operation, is provided by durable stainless steel balls and springs as well as the detents which form an integral part of the housing. All contact surfaces are fully enclosed within the housing, thus greatly reducing operational failures due to dirty contacts. The contacts are made of phosphor bronze with gold-over-nickel plating.

Alcoswitch Rotary Switches can be supplied with a variety of options to afford complete application versatility and adaptability. Output codes include decimal, BCD and BCD complement with 10, 12, 16, 24 and 32 switching positions.

Interconnection of switches may be achieved by the use of AMPMODU receptacles. Stops supplied with the switches may be customer installed when it is desired to limit rotation to less than 360°.

**PERFORMANCE CHARACTERISTICS**

- Circuit Current Rating—**
- Nonswitching** — 2.0 amperes at 115 VAC max.
- Switching (Resistive Load)** — 125 milliamperes at 115 VAC max.
- Dielectric Withstanding Voltage—**
- 500 VDC
- Insulation Resistance—**
- 1 x 10<sup>8</sup> ohms min. at 100 VDC
- Initial Contact Resistance—**
- 150 milliohms (input terminal to output terminal)
- Initial Operating Force—**
- 1/2 to 2 in.-lbs.
- Contact Life Expectancy—**
- 25,000 rotations at rated load
- Operating Temperature—**
- 18°C to +88°C

**MATERIALS**

- Housing—**
- Polyester, black
- Detent Ball and Spring—**
- Stainless steel
- Operating Shaft and Detent—**
- Thermoplastic, 94V-0 rated, black
- Printed Circuit Board—**
- Flame retardant, glass epoxy laminate, copper clad
- Contacts—**
- Phosphor bronze, gold-over-nickel plated
- Hardware—**
- Brass or corrosion resistant steel

**TECHNICAL DOCUMENTS**

- Product Specification—**
- 108-7518
- Instruction Sheet—**
- 408-07936

**Product Facts**

- ▢ **Code flexibility — switch output capabilities include decimal, BCD and BCD complement, and various other codes**
- ▢ **Positive switching — positive detent action of stainless steel detent balls and springs assures error-free operation**
- ▢ **Enclosed contacts — contact surfaces are better protected against dirt, dust and other environmental hazards**

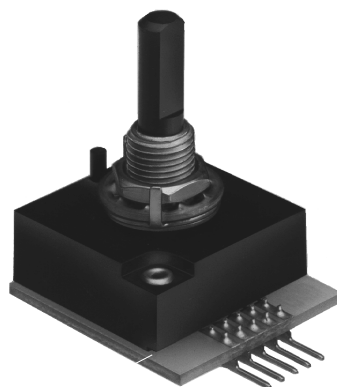

G

3100 Series

**Rotary Switches, PC Mount, 10, 12 or 16 Position**

10-, 12- AND 16-POSITION SWITCHES

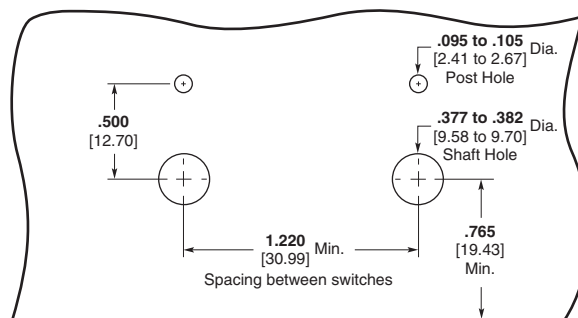
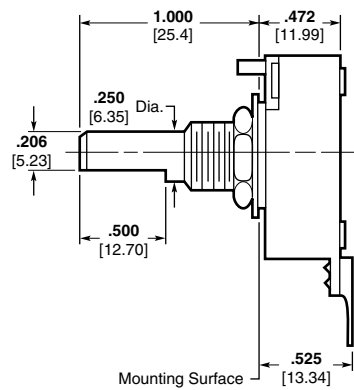
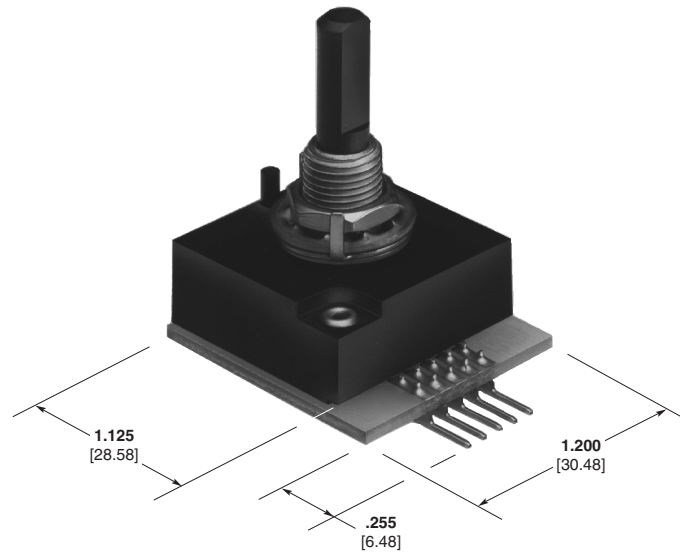

Panel Cutout

Note: See Section K for knob selection.

**Rotary Switches, PC Mount, 10, 12 or 16 Position**

**CODING**

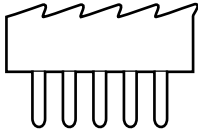

Part No.

2	1	C	8	4	435984-1,7
8	2	4	1	C	436037-1
1	2	C	8	4	435986-1
2	C	1	8	4	436022-1
C	4	8	1	2	436024-1
8	2	4	C	1	435987-1

10-Position  
36° Throw  
BCD

Part No. 435984-1 (Shown)  
Part No. 435984-7 (Right Angle)

Switch Position	Common to:			
	1	2	4	8
0				
1	●			
2		●		
3	●	●		
4			●	
5	●		●	
6		●	●	
7	●	●	●	
8				●
9	●			●

12-Position  
30° Throw  
BCD

Part No. 436037-1

Switch Position	Common to:			
	1	2	4	8
0				
1	●			
2		●		
3	●	●		
4			●	
5	●		●	
6		●	●	
7	●	●	●	
8				●
9	●			●
10		●		●
11	●	●		●

16-Position  
22½° Throw  
Hexadecimal

Part No. 435986-1

Switch Position	Common to:			
	1	2	4	8
0				
1	●			
2		●		
3	●	●		
4			●	
5	●		●	
6		●	●	
7	●	●	●	
8				●
9	●			●
10		●		●
11	●	●		●
12			●	●
13	●	●	●	
14		●	●	●
15	●	●	●	●

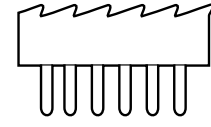

C 16 2 4 1 8

10-Position  
36° Throw  
BCD Complement  
Part No. 436022-1

Switch Position	Common to:			
	1	2	4	8
0	●	●	●	●
1		●	●	●
2	●		●	●
3			●	●
4	●	●		●
5		●		●
6	●			●
7				●
8	●	●	●	
9		●	●	

12-Position  
30° Throw  
BCD Complement  
Part No. 436024-1

Switch Position	Common to:			
	1	2	4	8
0	●	●	●	●
1		●	●	●
2	●		●	●
3			●	●
4	●	●		●
5		●		●
6	●			●
7				●
8	●	●	●	
9		●	●	
10	●		●	
11				●

16-Position  
22½° Throw  
HEX Complement  
Part No. 435987-1

Switch Position	Common to:			
	1	2	4	8
0	●	●	●	●
1		●	●	●
2	●		●	●
3			●	●
4	●	●		●
5		●		●
6	●			●
7				●
8	●	●	●	
9		●	●	
10	●		●	
11				●
12	●	●		
13			●	
14	●			
15				

24-Position  
15° Throw BCD  
Part No. 436028-1

Switch Position	Common to:			
	1	2	4	8 16
0				
1	●			
2		●		
3	●	●		
4			●	
5	●		●	
6		●	●	
7	●	●	●	
8				●
9	●			●
10		●		●
11	●	●		●
12			●	●
13	●	●	●	
14		●	●	●
15	●	●	●	●
16				●
17	●			●
18		●		●
19	●	●		●
20			●	●
21	●	●	●	●
22		●	●	●
23	●	●	●	●

Note: See Section K for knob selection.



**Rotary Switches, PC Mount, 32 Position**

32-POSITION  
11¼° THROW BCD  
PART NO. 436287-1

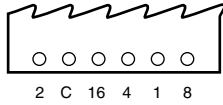

Switch Position	Common to:							
	1	2	4	8	16			
0								
1	•							
2		•						
3	•	•						
4			•					
5	•			•				
6		•	•					
7	•	•	•					
8							•	
9	•						•	
10		•					•	
11	•	•					•	
12			•	•				
13	•	•	•					
14		•	•					
15	•	•	•	•				
16								•
17	•							•
18		•						•
19	•	•						•
20			•					•
21	•		•					•
22		•	•					•
23	•	•	•					•
24				•	•			
25	•			•				•
26		•						•
27	•	•						•
28			•	•				
29	•		•	•				•
30		•	•	•	•			
31	•	•	•	•				

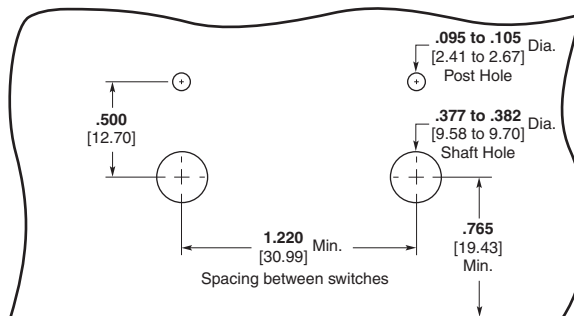
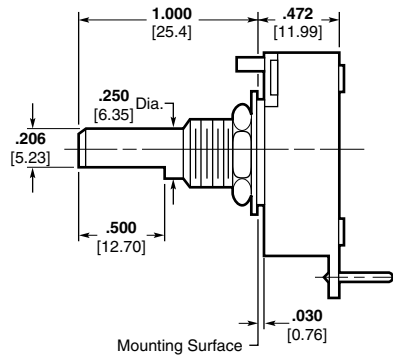
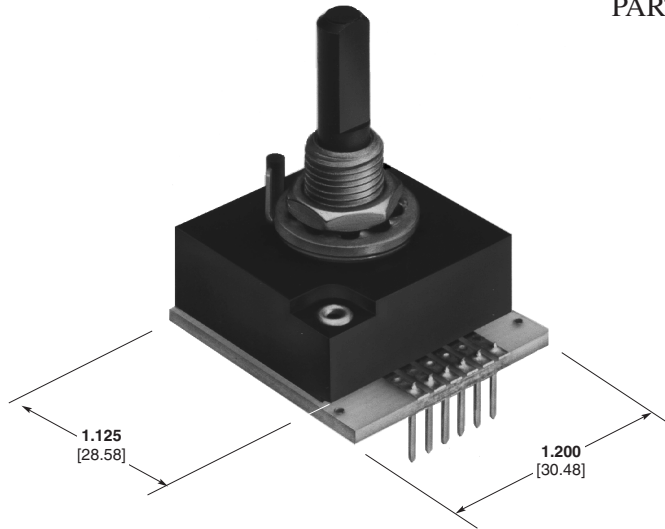

Note: See Section K for knob selection.

Panel Cutout

**Engineering Notes**



**G**

Engineering Notes