

FILTER - TUNABLE, BAND PASS SMT 9 - 19 GHz



Typical Applications

The HMC897LP4E is ideal for:

- Test & Measurement Equipment
- Military RADAR & EW/ECM
- SATCOM & Space
- Industrial & Medical Equipment

Features

- Fast Tuning Response
- Excellent Wideband Rejection
- Single Chip Replacement
for Mechanically Tuned Designs
- 24 Lead 4x4 mm SMT Package

Functional Diagram

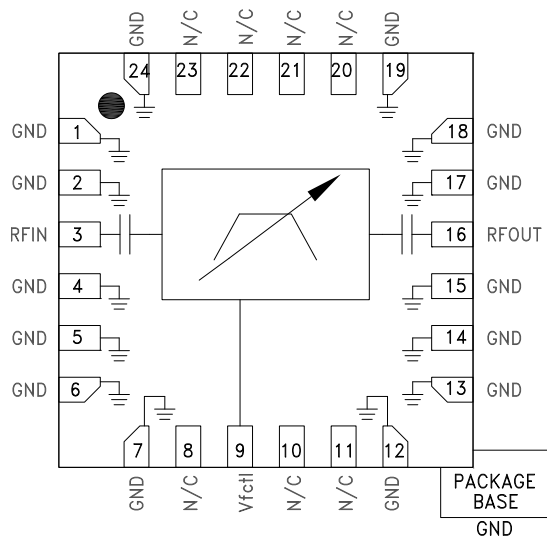

General Description

The HMC897LP4E is a MMIC band pass filter which features a user selectable passband frequency. The 3 dB filter bandwidth is approximately 18%. The 20 dB filter bandwidth is approximately 35%. The center frequency can be varied between 9 and 19 GHz by applying an analog tune voltage between 0 and 14V. This tunable filter can be used as a much smaller alternative to physically large switched filter banks and cavity tuned filters. The HMC897LP4E has excellent microphonics due to the monolithic design, and provides a dynamically adjustable solution in advanced communications applications.

Electrical Specifications, $T_A = +25^\circ\text{C}$

Parameter	Min.	Typ.	Max.	Units
F_{center} Tuning Range	9		19	GHz
3 dB Bandwidth		18		%
Low Side Rejection Frequency (Rejection >20 dB)		$0.81 * F_{\text{center}}$		GHz
High Side Rejection Frequency (Rejection >20 dB)		$1.17 * F_{\text{center}}$		GHz
Low Side Sub-Harmonic Rejection (Rejection >40 dB)		$0.58 * F_{\text{center}}$		GHz
High Side Sub-Harmonic Rejection (Rejection >40 dB)		$1.23 * F_{\text{center}}$		GHz
Re-entry Frequency (Rejection <30 dB)		>40		GHz
Insertion Loss		6.5		dB
Return Loss		9.5		dB
Input IP3 (Pin = 0 to +20 dBm)		30		dBm
Input Power @ 5° Shift In Insertion Phase ($V_{\text{fctl}} = 0\text{V}$)		10		dBm
Input Power @ 5° Shift In Insertion Phase ($V_{\text{fctl}} > = 1\text{V}$)		15		dBm
Frequency Control Voltage (V_{fctl})	0		14	V
Source/Sink Current (I_{fctl})			± 1	mA
Residual Phase Noise [1] (100 kHz Offset)		-160		dBc/Hz
F_{center} Drift Rate		-1.65		MHz/°C
Tuning Characteristics [2] t_{FULLBAND} (0% V_{fctl} to 90% RF)		200		ns

[1] Optimum residual phase noise performance requires the use of a low noise driver circuit.

[2] Tuning speed is dependent on driver circuit. Data measured with a high speed op-amp driver and includes driver slew rate delay.

**FILTER - TUNABLE, BAND PASS SMT
9 - 19 GHz**



Broadband Insertion Loss vs. Vfctl

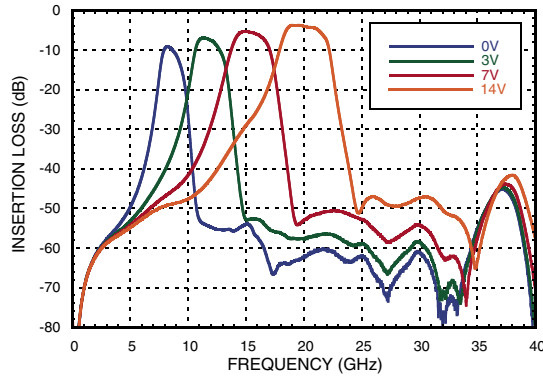

Broadband Return Loss vs. Vfctl

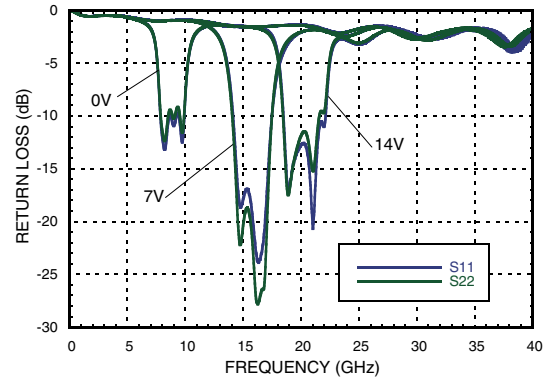

Insertion Loss vs. Vfctl

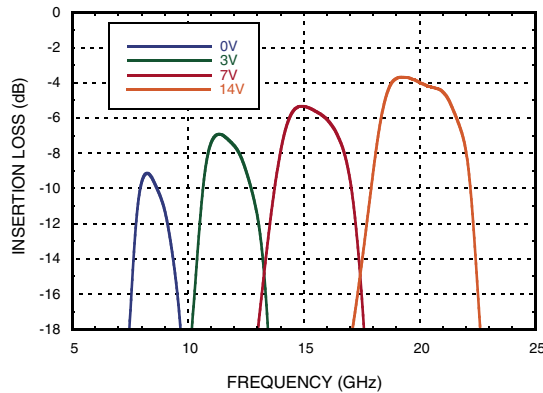

Return Loss vs. Vfctl

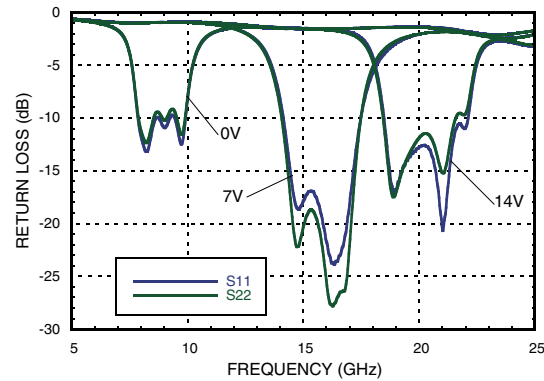

Insertion Loss vs. Temperature, Vfctl = 7V

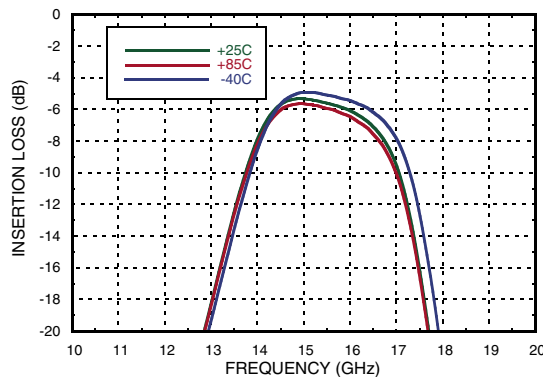

Return Loss vs. Temperature, Vfctl = 7V

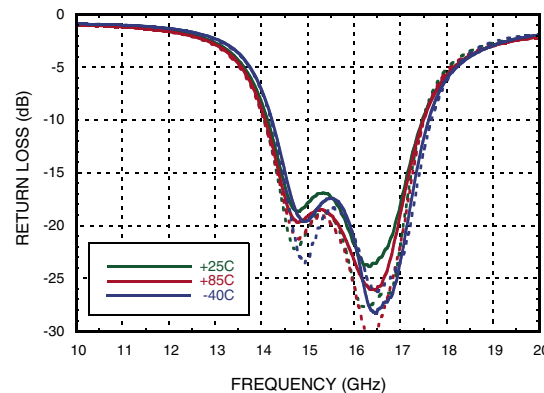



**FILTER - TUNABLE, BAND PASS SMT
9 - 19 GHz**

Center Frequency vs. Temperature

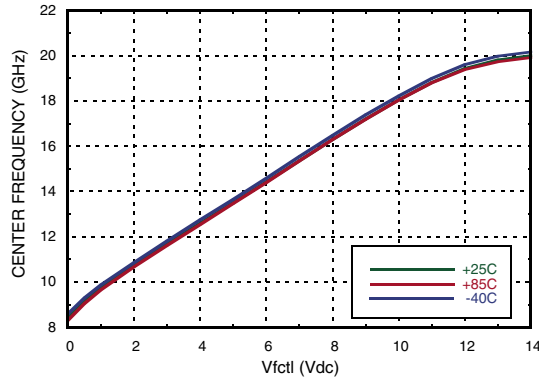

Insertion Loss vs. Temperature

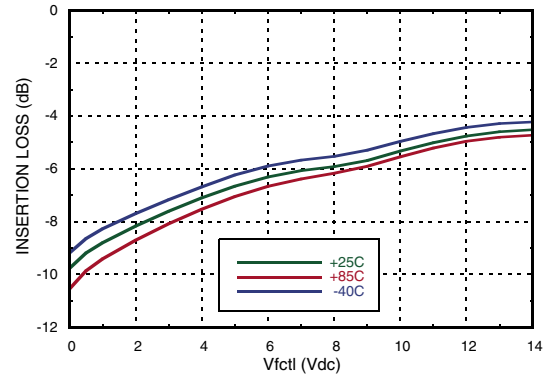

3 dB Bandwidth vs. Temperature

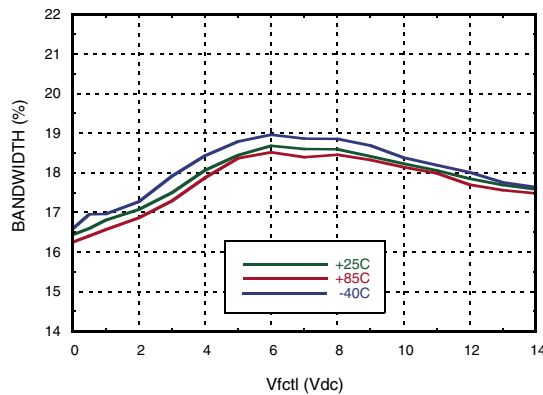

Maximum Return Loss in a 2 dB Bandwidth vs. Temperature

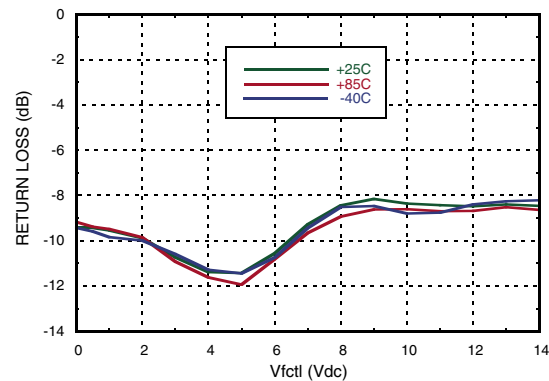

Low Side Rejection Ratio vs. Temperature [1]

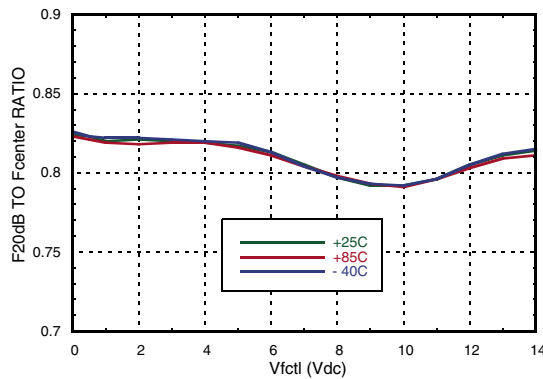

High Side Rejection Ratio vs. Temperature [1]

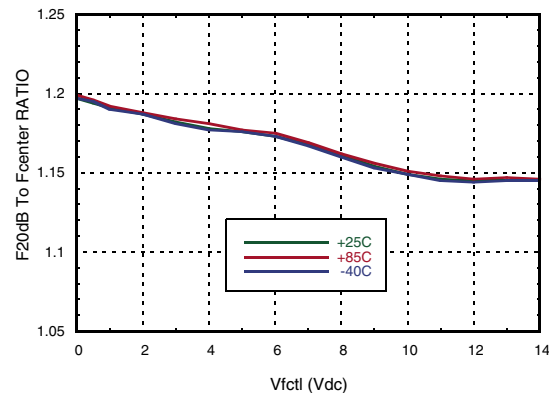

[1] Rejection ratio is defined as the ratio of the frequency at which the relative insertion loss is 20 dB to f_{center}

**FILTER - TUNABLE, BAND PASS SMT
9 - 19 GHz**



Tuning Sensitivity vs. Temperature

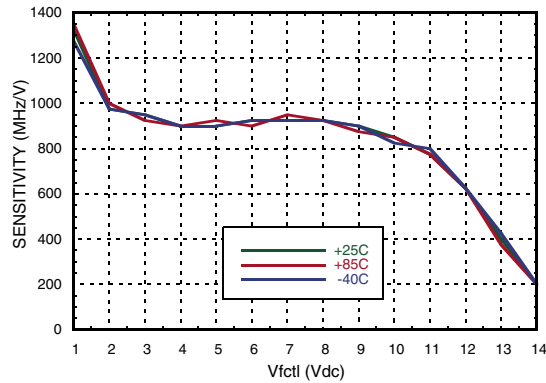

Group Delay

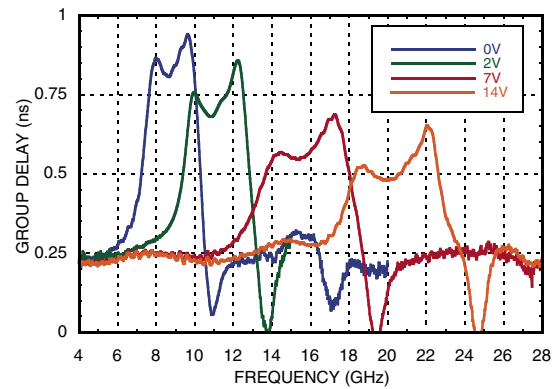

Group Delay vs. Fcenter vs. Temperature

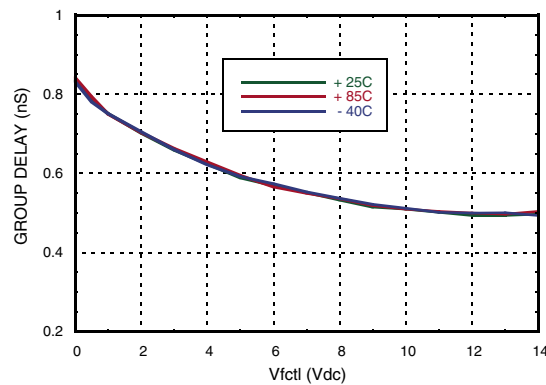

Input IP3 vs. Temperature

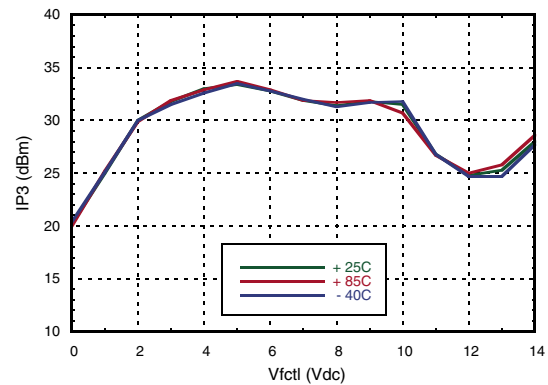

Residual Phase Noise

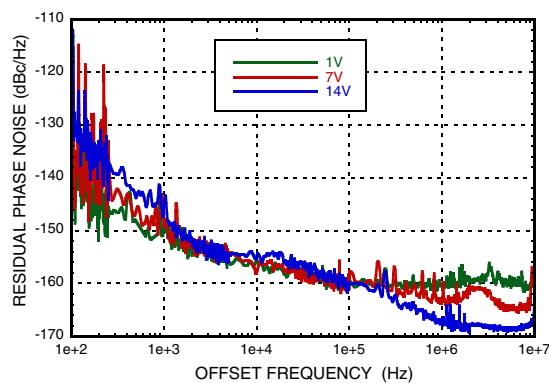

Phase Sensitivity vs. Vctrl

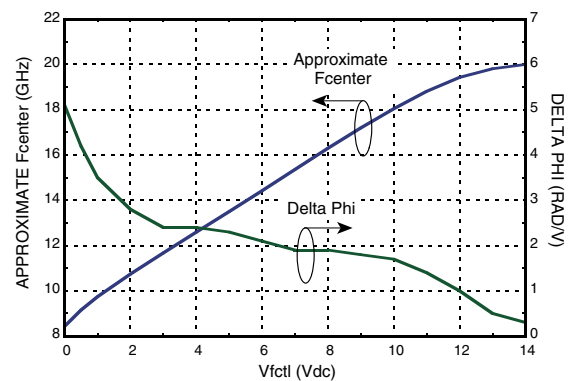

Information furnished by Analog Devices is believed to be accurate and reliable. However, no responsibility is assumed by Analog Devices for its use, nor for any infringements of patents or other rights of third parties that may result from its use. Specifications subject to change without notice. No license is granted by implication or otherwise under any patent or patent rights of Analog Devices. Trademarks and registered trademarks are the property of their respective owners.

For price, delivery, and to place orders: Analog Devices, Inc., One Technology Way, P.O. Box 9106, Norwood, MA 02062-9106 Phone: 781-329-4700 • Order online at www.analog.com Application Support: Phone: 1-800-ANALOG-D



**FILTER - TUNABLE, BAND PASS SMT
9 - 19 GHz**

Phase Shift vs. Pin

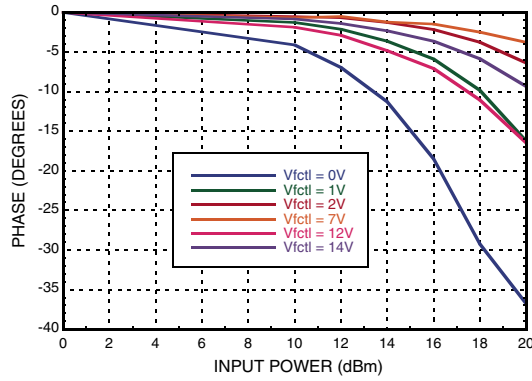

Frequency Shift vs. Pin

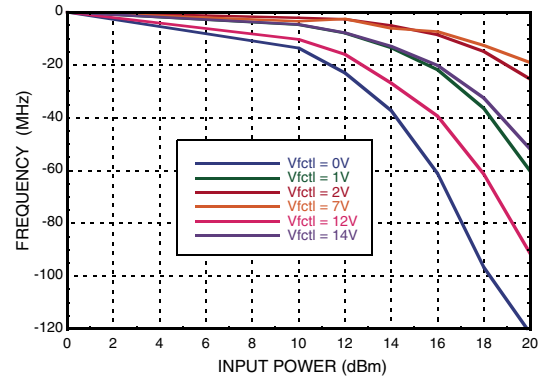

Absolute Maximum Ratings

Frequency Control Voltage (Vfctl)	-0.5 to +15V
RF Power Input	27 dBm
Storage Temperature	-65 to +150 °C
ESD Sensitivity (HBM)	Class 1A

Reliability Information

Junction Temperature to Maintain 1 Million Hour MTTF	150 °C
Nominal Junction Temperature (T= 85 °C and Pin = 27 dBm)	108 °C
Operating Temperature	-40 to +85 °C



**ELECTROSTATIC SENSITIVE DEVICE
OBSERVE HANDLING PRECAUTIONS**

Information furnished by Analog Devices is believed to be accurate and reliable. However, no responsibility is assumed by Analog Devices for its use, nor for any infringements of patents or other rights of third parties that may result from its use. Specifications subject to change without notice. No license is granted by implication or otherwise under any patent or patent rights of Analog Devices. Trademarks and registered trademarks are the property of their respective owners.

For price, delivery, and to place orders: Analog Devices, Inc., One Technology Way, P.O. Box 9106, Norwood, MA 02062-9106
Phone: 781-329-4700 • Order online at www.analog.com
Application Support: Phone: 1-800-ANALOG-D

FILTER - TUNABLE, BAND PASS SMT 9 - 19 GHz



Outline Drawing

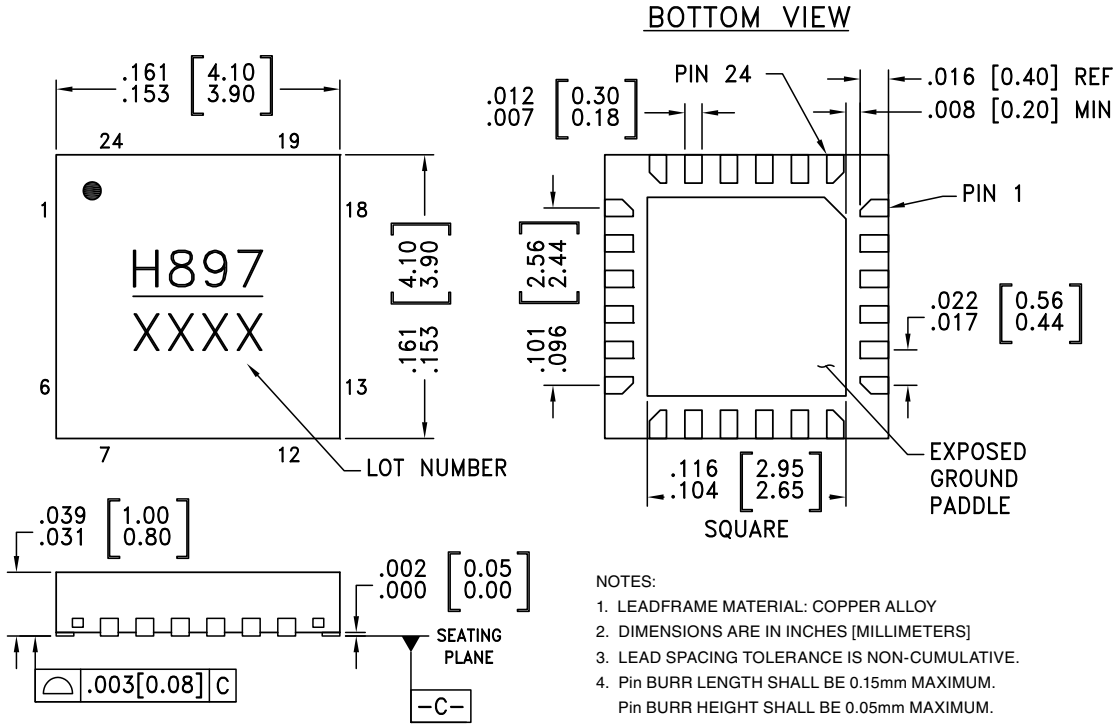

NOTES:

1. LEADFRAME MATERIAL: COPPER ALLOY
2. DIMENSIONS ARE IN INCHES [MILLIMETERS]
3. LEAD SPACING TOLERANCE IS NON-CUMULATIVE.
4. Pin BURR LENGTH SHALL BE 0.15mm MAXIMUM.
Pin BURR HEIGHT SHALL BE 0.05mm MAXIMUM.
5. PACKAGE WARP SHALL NOT EXCEED 0.05mm.
6. ALL GROUND LEADS AND GROUND PADDLE MUST BE SOLDERED TO PCB RF GROUND.
7. REFER TO HITTITE APPLICATION NOTE FOR SUGGESTED LAND PATTERN.

Package Information

Part Number	Package Body Material	Lead Finish	MSL Rating	Package Marking ^[1]
HMC897LP4E	RoHS-compliant Low Stress Injection Molded Plastic	100% matte Sn	MSL1 ^[2]	H897 XXXX

[1] 4-Digit lot number XXXX

[2] Max peak reflow temperature of 260 °C



**FILTER - TUNABLE, BAND PASS SMT
9 - 19 GHz**

Pin Descriptions

Pin Number	Function	Description	Interface Schematic
8, 10, 11, 20 - 23	N/C	The pins are not connected internally; however, all data shown herein was measured with these pins connected to RF/DC ground externally.	
1, 2, 4 - 7, 12 - 15, 17 - 19, 24	GND	These pins and exposed paddle must be connected to RF/DC ground.	
3	RFIN	This pin is AC coupled and matched to 50 Ohms.	
9	Vctl	Center frequency control voltage.	
16	RFOUT	This pin is AC coupled and matched to 50 Ohms.	

Application Circuit

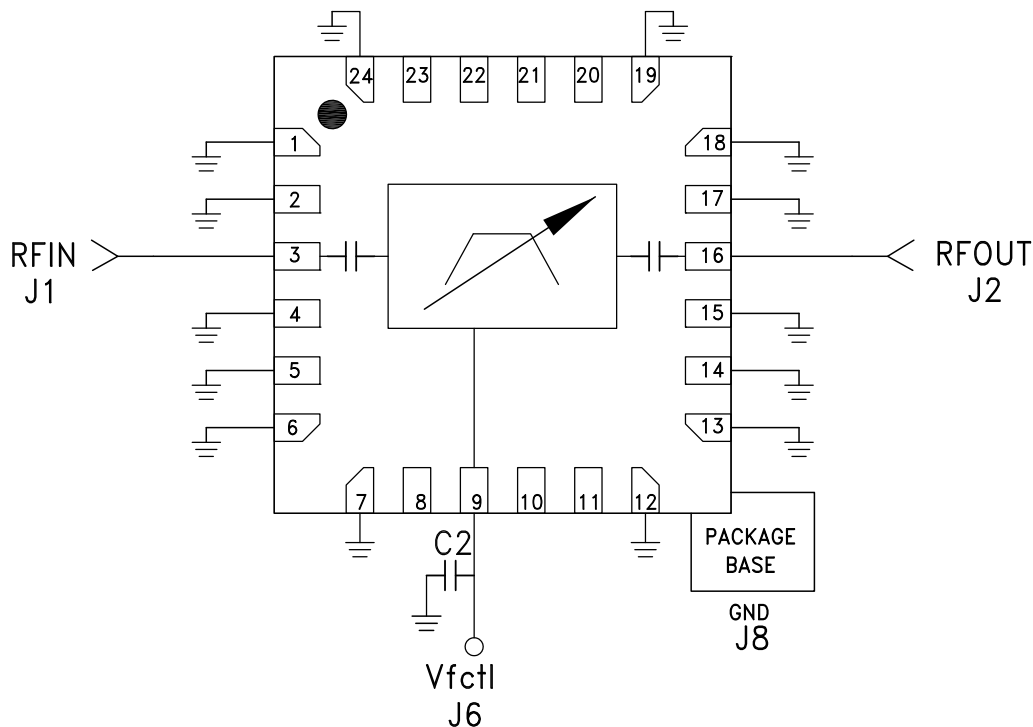

Information furnished by Analog Devices is believed to be accurate and reliable. However, no responsibility is assumed by Analog Devices for its use, nor for any infringements of patents or other rights of third parties that may result from its use. Specifications subject to change without notice. No license is granted by implication or otherwise under any patent or patent rights of Analog Devices. Trademarks and registered trademarks are the property of their respective owners.

For price, delivery, and to place orders: Analog Devices, Inc., One Technology Way, P.O. Box 9106, Norwood, MA 02062-9106 Phone: 781-329-4700 • Order online at www.analog.com Application Support: Phone: 1-800-ANALOG-D



Evaluation PCB

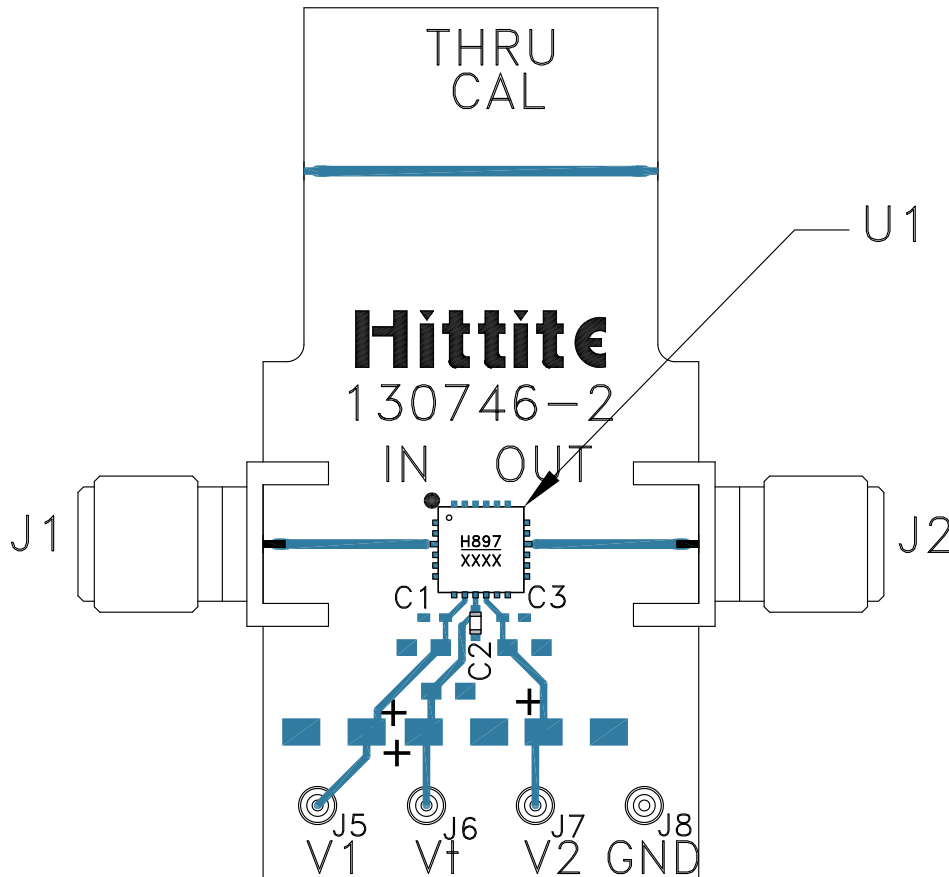

List of Materials for Evaluation PCB 131086 [1]

Item	Description
J1, J2	PCB Mount K-Connector
J6, J8	DC Pin
C2	100 pF Capacitor, 0402 Pkg.
U1	HMC897LP4E Filter - Tunable
PCB [2]	130746 Evaluation PCB

[1] Reference this number when ordering complete evaluation PCB

[2] Circuit Board Material: Arlon 25FR or Rogers 25FR

The circuit board used in the application should use RF circuit design techniques. Signal lines should have 50 Ohms impedance while the package ground leads and exposed paddle should be connected directly to the ground plane similar to that shown. A sufficient number of via holes should be used to connect the top and bottom ground planes. The evaluation circuit board shown is available from Hittite upon request.