

## Sensus™ LED Series

### Pure White Targeted COB Arrays Below the Black Body Locus (BBL) Preliminary Data Sheet



#### Table of Contents

Technology Overview .....2

Test Specifications .....2

Chromaticity Bins .....3

Product Ordering & Shipping  
Part Numbers .....4

Product Typical Flux Range 5

Operating Characteristics ..7

Optical and Electrical Character-  
istics..... 12

Spectra ..... 19

Mechanical Dimensions .. 20

Packaging Information ... 20

Handling Notes ..... 28

#### Features:

- Matching the human perception of “Pure white” light
- Designed to provide the look and feel of ceramic metal halide lights
- Wide product range from 300lm to over 7,500lm
- 3000K, 80 CRI standard
- 2-step and 3-step MacAdam Ellipse color binning accuracy
- Excellent optical uniformity and color over angle consistency
- Exceptional long term color stability
- Superior thermal conductivity for uniform heat spreading
- Environmentally friendly: RoHS and REACH compliant
- UL Recognized, File # E465703



#### Applications

- Retail Shop Lighting
- Spotlights/Track Lights
- CMH replacement LED lamps
- Halogen replacement LED lamps
- Hospitality Lighting
- Architectural and Specialty

## Technology Overview

Luminus XNova™ Chip-on-Board (COB) LED series offers a complete lighting class solution designed for high performance illumination applications. The Sensus LED series has been specially design for retail shop lighting where enhanced red coloring is a preferred lighting standard. The selection covers a wide lumen range from less than 300lm to over 3,000lm, and is focused on the major market color and CRI of 3000K and 80 CRI. These innovative breakthroughs allow illumination engineers and designers to develop lighting solutions with maximum efficacy, brightness and overall quality.

### Reliability

Designed from the ground up, the XNova™ COB LED is one of the most reliable light sources in the world today. Having passed a rigorous suite of environmental and mechanical stress tests, including mechanical shock, vibration, temperature cycling and humidity. Only then are the devices qualified for use in a wide range of lighting application including some of the most demanding commercial applications. Delivered with fully qualified LM-80 test data and TM-21 lifetime results that certify lumen maintenance at 35,000 hours or more, XNova™ COB LEDs are ready for the toughest challenges.

### UL Recognized Compliance

XNova COB arrays are tested in accordance with ANSI/UL 8750 to ensure safe operation for their intended applications.

### REACH & RoHS Compliance

All LED products manufactured by Luminus are REACH and RoHS compliant and free of hazardous materials, including lead and mercury.

## Understanding XNova™ COB LED Test Specifications

Every XNova™ LED is fully tested to ensure it meets the high quality standards customers have come to expect from Luminus' products.

### Traceability

Each XNova COB LED is marked with a 2D bar code that contains a unique serial number. With this serial number, Luminus has the ability to provide customers with actual test data measurements for a specific LED. In addition, the 2D bar code is linked to manufacturing date codes that enables traceability of production processes and materials.

### Chromaticity Bin Range

Chromaticity binning delivers color consistency for every order. Standard products are delivered with a 3-step MacAdam ellipse. This ensures color performance matching in the application. For the most demanding application, Luminus is one of only a few companies that can provide a 2-step ellipse bin. These tightly controlled, small distribution bins provide customers predictable, repeatable colors.

### Testing Temperature

XNova™ COB products are measured at temperatures typical for the LED operating in the fixture. Each device is tested at 85°C junction temperature eliminating the need to scale data sheet specifications to real world situations.

### Chromaticity Bin Structure

Chromaticity Bins: 1931 CIE Curve

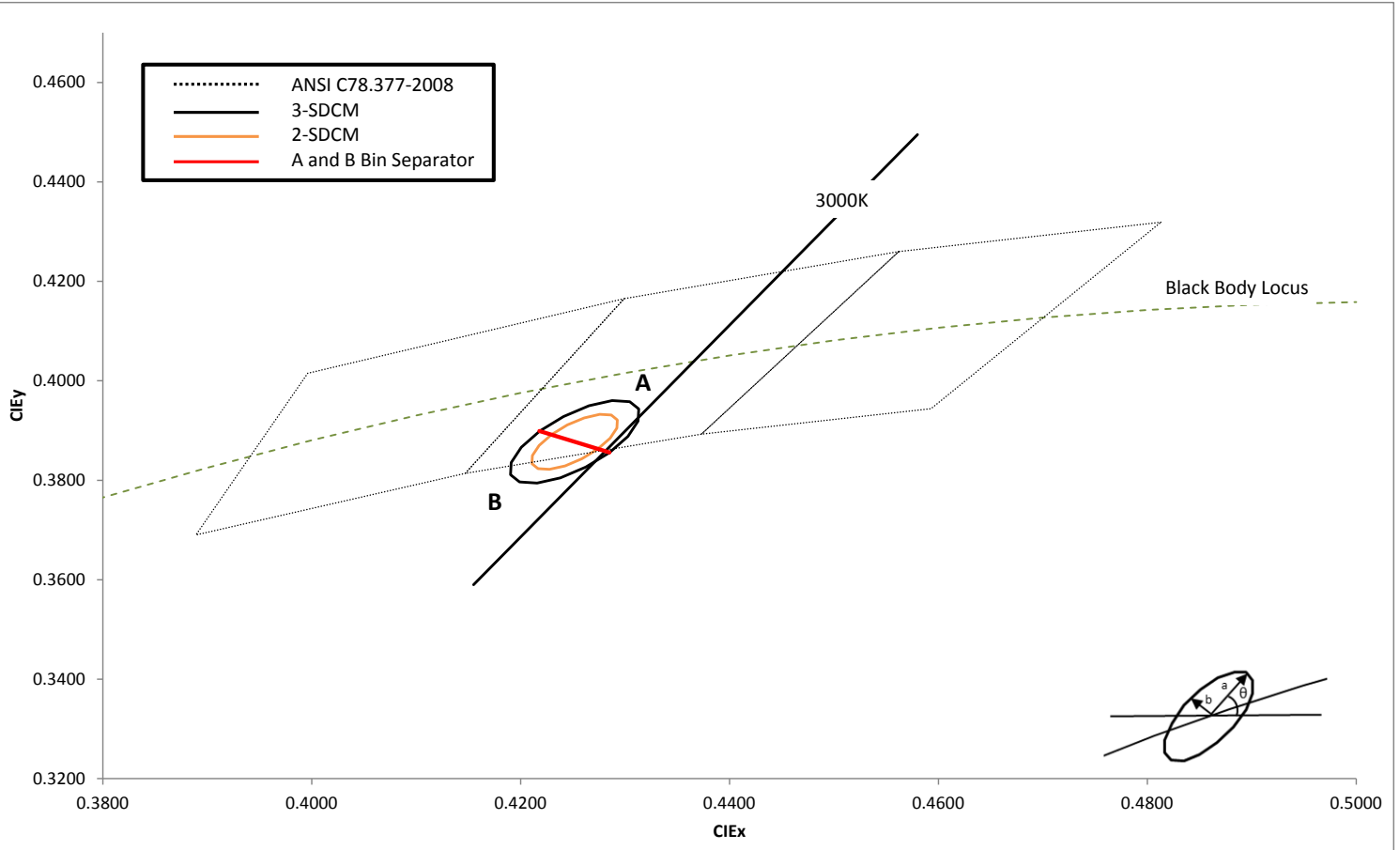

### Sensus™ LED White Chromaticity Bins

The following tables describe the ANSI bin center points, the orientation angle for the MacAdam ellipse ( $\theta^\circ$ ), and the maximum radii for the ellipses. The ANSI Bin is provided for reference.

CCT	Center Point		$\theta^\circ$	2-step Bin		3-step Bin		
	CIE <sub>x</sub>	CIE <sub>y</sub>		a	b	$\theta^\circ$	a	b
3000K	0.4285	0.3933	53.6	0.00556	0.00272	53.1	0.00834	0.00408

The chromaticity range is sorted into two sections, "A" and "B" for delivered product. The position for the separator line dividing the bins is described in the following table by a line connecting points at CIE<sub>x</sub> and CIE<sub>y</sub> coordinates that lie on the 2-step and 3-step ellipse.

Separator	2-step Bin		3-step Bin	
Position	CIE <sub>x</sub>	CIE <sub>y</sub>	CIE <sub>x</sub>	CIE <sub>y</sub>
Right Side	0.4274	0.3863	0.4285	0.3856
Left Side	0.4229	0.3892	0.4218	0.3899

\*Note: Luminus maintains a +/- 0.005 tolerance on chromaticity (CIE<sub>x</sub> and CIE<sub>y</sub>) measurements.

## Product Ordering and Shipping Part Number Nomenclature

All Sensus LED products are packaged and labeled with part numbers as outlined in the table on page 5 and 6. Luminus will include any smaller chromaticity bin that is contained in the larger bin as part of the ordered part. When shipped, each package will contain only a single flux and chromaticity bin. The part number designation is as follows:

Sensus™ LED Series														
CXM	—	XX	—	30	—	XX	—	36	—	QQPP	—	FG	—	W
Product Family	Light Emitting Surface Diameter <sup>1</sup>	Color Temperature	Color Rendering Index (CRI) <sup>3</sup>	Voltage (typical)	Package Configurator	Flux Bin	Chromaticity Bin							
CXM: Chip on Board	XX: LES Diameter (mm) Approximate	3000K	CRI	Volts	AA02 (Basic package)	Lumens	See page 4 for bins							

Note 1: XX nomenclature corresponds to the following:

- 6 = 6.3mm
- 7 = 7.5mm
- 9 = 9mm
- 14 = 13.5mm
- 18 = 17.5mm
- 22 = 22mm

Note 2: AA02 is a standard package configurator  
AC02 is an alternative substrate size

Note 3: Shipped product will be delivered with the 2-step or 3-step chromaticity bin divided into section "A" and section "B" as shown in the chromaticity diagram. While these sub-bins are not available for direct purchase, it is hoped this fine binning can add another design dimension to select customer's products. The packaged product will have the sub bin shown on the label at the end of the Customer Part Number from page 5 and 6.

### Color Temperature, CRI and R9 Values

Color Temperatures	XX Value	CRI	R9
3000K	80	>80	>0
	90	>90	>50

Note: Luminus part numbers may be accompanied by prefixes or suffixes. The most common is the "Rev01" suffix indicating a part is fully released and carries a full warranty. These additional characters may appear on shipping labels, packing slips and invoices. In all cases the basic part number described above will always be included.

**Sensus™ LED Series Part Numbers (Typical)**

The following tables describe products with typical flux and minimum flux measured at typical currents and specified at 85°C. The values at 25°C are calculated and shown for reference only. All products are measured and specified at 85°C junction temperature. Luminus may choose to ship a smaller chromaticity bin in an order for a larger.

Output Flux (lm)			Typ. Current (mA)	Ordering Part Number	
Typ. (85°C)	Min. (85°C)	Typ. (calculated) (25°C)		3-step MacAdam Ellipse	2-step MacAdam Ellipse
445	420	495	120	CXM-6-30-80-36-AA02-F2-3	CXM-6-30-80-36-AA02-F2-2
585	555	645	160	CHM-6-30-80-36-AA02-F2-3	CHM-6-30-80-36-AA02-F2-2
615	585	685	160	CXM-7-30-80-36-AA02-F2-3	CXM-7-30-80-36-AA02-F2-2
625	590	695	160	CLM-9-30-80-36-AC02-F2-3	CLM-9-30-80-36-AC02-F2-2
				CLM-9-30-80-36-AA02-F2-3	CLM-9-30-80-36-AC02-F2-2
930	885	1,025	240	CXM-9-30-80-36-AC02-F2-3	CXM-9-30-80-36-AC02-F2-2
				CXM-9-30-80-36-AA02-F2-3	CXM-9-30-80-36-AA02-F2-2
780	750	870		CXM-9-30-90-36-AC02-F2-3	CXM-9-30-90-36-AC02-F2-2
				CXM-9-30-90-36-AA02-F2-3	CXM-9-30-90-36-AA02-F2-2
1,310	1,245	1,455	360	CHM-9-30-80-36-AC02-F2-3	CHM-9-30-80-36-AC02-F2-2
				CHM-9-30-80-36-AA02-F2-3	CHM-9-30-80-36-AA02-F2-2
1,110	1,050	1,230		CHM-9-30-90-36-AC02-F2-3	CHM-9-30-90-36-AC02-F2-2
				CHM-9-30-90-36-AA02-F2-3	CHM-9-30-90-36-AA02-F2-2
1,930	1,830	2,135	480	CXM-14-30-80-36-AC02-F2-3	CXM-14-30-80-36-AC02-F2-2
				CXM-14-30-80-36-AA02-F2-3	CXM-14-30-80-36-AA02-F2-2
1,635	1,550	1,810		CXM-14-30-90-36-AC02-F2-3	CXM-14-30-90-36-AC02-F2-2
				CXM-14-30-90-36-AA02-F2-3	CXM-14-30-90-36-AA02-F2-2
2,660	2,525	2,925	720	CHM-14-30-80-36-AC02-F2-3	CHM-14-30-80-36-AC02-F2-2
				CHM-14-30-80-36-AA02-F2-3	CHM-14-30-80-36-AA02-F2-2
2,255	2,140	2,475		CHM-14-30-90-36-AC02-F2-3	CHM-14-30-90-36-AC02-F2-2
				CHM-14-30-90-36-AA02-F2-3	CHM-14-30-90-36-AA02-F2-2

\*Note: Luminus maintains a +/- 6% tolerance on flux measurements.

Luminus maintains a +/- 2% tolerance on CRI measurements.

**Sensus™ LED Series Part Numbers (Typical)**

The following tables describe products with typical flux and minimum flux measured at typical currents and specified at 85°C. The values at 25°C are calculated and shown for reference only. All product is measured and specified at 85°C junction temperature. Luminus may choose to ship a smaller chromaticity bin in an order for a larger.

Output Flux (lm)			Typ. Current (mA)	Ordering Part Number	
Typ. (85°C)	Min. (85°C)	Typ. (calculated) (25°C)		3-step MacAdam Ellipse	2-step MacAdam Ellipse
3,210	3,050	3,560	800	CXM-18-30-80-36-AA02-F2-3	CXM-18-30-80-36-AA02-F2-2
4,435	4,210	4,875	1,200	CHM-18-30-80-36-AA02-F2-3	CHM-18-30-80-36-AA02-F2-2
5,130	4,870	5,700	1,280	CXM-22-30-80-36-AC02-F2-3	CXM-22-30-80-36-AC02-F2-2
7,090	6,735	7,800	1,920	CHM-22-30-80-36-AC02-F2-3	CHM-22-30-80-36-AC02-F2-2

\*Note: Luminus maintains a +/- 6% tolerance on flux measurements.

Luminus maintains a +/- 2% tolerance on CRI measurements.

### CXM-6 Operating Characteristics<sup>1</sup>

#### Optical and Electrical Characteristics

Parameter	Symbol	Minimum	Typical	Maximum	Unit
Forward Current (36V) <sup>2</sup>	I <sub>f</sub>		120	240	mA
Forward Current (18V) <sup>2</sup>			240	480	
Forward Current (9V) <sup>2</sup>			480	960	
Forward Voltage <sup>3</sup>	V <sub>f</sub>	33.5	35	37.5	V
		16.8	17.5	18.8	
		8.4	8.8	9.4	
Power			4.3	9	W
Operating Case Temperature <sup>4</sup>	T <sub>c</sub>			105	°C
Light Emitting Surface Diameter	LES		6.3		mm
Thermal Resisance (junction-to-case)	Θ <sub>jc</sub>		2.33		°C/W
Junction Temperature	T <sub>j</sub>			140	°C
Viewing Angle			120		Degree

### CXM-7 Operating Characteristics<sup>1</sup>

#### Optical and Electrical Characteristics

Parameter	Symbol	Minimum	Typical	Maximum	Unit
Forward Current (36V) <sup>2</sup>	I <sub>f</sub>		160	320	mA
Forward Current (18V) <sup>2</sup>			320	640	
Forward Current (9V) <sup>2</sup>			640	1280	
Forward Voltage <sup>3</sup>	V <sub>f</sub>	33.5	35	37.5	V
		16.8	17.5	18.8	
		8.4	8.8	9.4	
Power			5.6	13	W
Operating Case Temperature <sup>4</sup>	T <sub>c</sub>			105	°C
Light Emitting Surface Diameter	LES		7.5		mm
Thermal Resisance (junction-to-case)	Θ <sub>jc</sub>		1.9		°C/W
Junction Temperature	T <sub>j</sub>			140	°C
Viewing Angle			120		Degree

### CHM-6 Operating Characteristics<sup>1</sup>

#### Optical and Electrical Characteristics

Parameter	Symbol	Minimum	Typical	Maximum	Unit
Forward Current (36V) <sup>2</sup>	I <sub>f</sub>		160	320	mA
Forward Current (9V) <sup>2</sup>			640	1280	
Forward Voltage <sup>3</sup>	V <sub>f</sub>	33.5	35	37.5	V
		8.4	8.8	9.4	
Power			5.6	13	W
Operating Case Temperature <sup>4</sup>	T <sub>c</sub>			105	°C
Light Emitting Surface Diameter	LES		6.3		mm
Thermal Resisittance (junction-to-case)	Θ <sub>jc</sub>		1.55		°C/W
Junction Temperature	T <sub>j</sub>			140	°C
Viewing Angle			120		Degree

### CLM-9 Operating Characteristics<sup>1</sup>

#### Optical and Electrical Characteristics

Parameter	Symbol	Minimum	Typical	Maximum	Unit
Forward Current <sup>2</sup>	I <sub>f</sub>		160	350	mA
Forward Voltage <sup>3</sup>	V <sub>f</sub>	33.5	35	37.5	V
Power			5.6	12	W
Operating Case Temperature <sup>4</sup>	T <sub>c</sub>			105	°C
Light Emitting Surface Diameter	LES		9.0		mm
Thermal Resisittance (junction-to-case)	Θ <sub>jc</sub>		1.55		°C/W
Junction Temperature	T <sub>j</sub>			140	°C
Viewing Angle			120		Degree



### CXM-9 Operating Characteristics<sup>1</sup>

#### Optical and Electrical Characteristics

Parameter	Symbol	Minimum	Typical	Maximum	Unit
Forward Current <sup>2</sup>	$I_f$		240	530	mA
Forward Voltage <sup>3</sup>	$V_f$	33.5	35	37.5	V
Power			8.6	21	W
Operating Case Temperature <sup>4</sup>	$T_c$			100	°C
Light Emitting Surface Diameter	LES		9		mm
Thermal Resisitance (junction-to-case)	$\Theta_{jc}$		1.51		°C/W
Junction Temperature	$T_j$			140	°C
Viewing Angle			120		Degree

### CHM-9 Operating Characteristics<sup>1</sup>

#### Optical and Electrical Characteristics

Parameter	Symbol	Minimum	Typical	Maximum	Unit
Forward Current <sup>2</sup>	$I_f$		360	720	mA
Forward Voltage <sup>3</sup>	$V_f$	33.5	35	37.5	V
Power			12.6	26	W
Operating Case Temperature <sup>4</sup>	$T_c$			105	°C
Light Emitting Surface Diameter	LES		9		mm
Thermal Resisitance (junction-to-case)	$\Theta_{jc}$		0.85		°C/W
Junction Temperature	$T_j$			140	°C
Viewing Angle			120		Degree

### CXM-14 Operating Characteristics<sup>1</sup>

#### Optical and Electrical Characteristics

Parameter	Symbol	Minimum	Typical	Maximum	Unit
Forward Current <sup>2</sup>	$I_f$		480	1,000	mA
Forward Voltage <sup>3</sup>	$V_f$	33.5	35	37.5	V
Power			17.3	40	W
Operating Case Temperature	$T_c$			105	°C
Light Emitting Surface Diameter	LES		13.5		mm
Thermal Resisitance (junction-to-case)	$\Theta_{jc}$		0.87		°C/W
Junction Temperature	$T_j$			140	°C
Viewing Angle			120		Degree

### CHM-14 Operating Characteristics<sup>1</sup>

#### Optical and Electrical Characteristics

Parameter	Symbol	Minimum	Typical	Maximum	Unit
Forward Current <sup>2</sup>	$I_f$		720	1,440	mA
Forward Voltage <sup>3</sup>	$V_f$	33.5	35	37.5	V
Power			25.2	50.4	W
Operating Case Temperature	$T_c$			105	°C
Light Emitting Surface Diameter	LES		13.5		mm
Thermal Resisitance (junction-to-case)	$\Theta_{jc}$		0.46		°C/W
Junction Temperature	$T_j$			140	°C
Viewing Angle			120		Degree

### CXM-18 Operating Characteristics<sup>1</sup>

#### Optical and Electrical Characteristics

Parameter	Symbol	Minimum	Typical	Maximum	Unit
Forward Current <sup>2</sup>	$I_f$		800	1,600	mA
Forward Voltage <sup>3</sup>	$V_f$	33.5	35	37.5	V
Power			29	65	W
Operating Case Temperature <sup>4</sup>	$T_c$			105	°C
Light Emitting Surface Diameter	LES		17.5		mm
Thermal Resisitance (junction-to-case)	$\Theta_{jc}$		0.56		°C/W
Junction Temperature	$T_j$			140	°C
Viewing Angle			120		Degree

### CHM-18 Operating Characteristics<sup>1</sup>

#### Optical and Electrical Characteristics

Parameter	Symbol	Minimum	Typical	Maximum	Unit
Forward Current <sup>2</sup>	$I_f$		1,200	2,400	mA
Forward Voltage <sup>3</sup>	$V_f$	33.5	35	37.5	V
Power			42	96	W
Operating Case Temperature <sup>4</sup>	$T_c$			105	°C
Light Emitting Surface Diameter	LES		17.5		mm
Thermal Resisitance (junction-to-case)	$\Theta_{jc}$		0.30		°C/W
Junction Temperature	$T_j$			140	°C
Viewing Angle			120		Degree

### CXM-22 Operating Characteristics<sup>1</sup>

#### Optical and Electrical Characteristics

Parameter	Symbol	Minimum	Typical	Maximum	Unit
Forward Current <sup>2</sup>	$I_f$		1,280	2,560	mA
Forward Voltage <sup>3</sup>	$V_f$	33.5	35	37.5	V
Power			45	90	W
Operating Case Temperature <sup>4</sup>	$T_c$			105	°C
Light Emitting Surface Diameter	LES		22		mm
Thermal Resisance (junction-to-case)	$\Theta_{jc}$		0.37		°C/W
Junction Temperature	$T_j$			140	°C
Viewing Angle			120		Degree

### CHM-22 Operating Characteristics<sup>1</sup>

#### Optical and Electrical Characteristics

Parameter	Symbol	Minimum	Typical	Maximum	Unit
Forward Current <sup>2</sup>	$I_f$		1,920	3,840	mA
Forward Voltage <sup>3</sup>	$V_f$	33.5	35	37.5	V
Power			67	90	W
Operating Case Temperature <sup>4</sup>	$T_c$			105	°C
Light Emitting Surface Diameter	LES		22		mm
Thermal Resisance (junction-to-case)	$\Theta_{jc}$		0.2		°C/W
Junction Temperature	$T_j$			140	°C
Viewing Angle			120		Degree

### Operating Characteristics Notes

- Note 1: Ratings are based on operation at a constant junction temperature of  $T_j = 85^\circ\text{C}$ .
- Note 2: To prevent damage refer to operating conditions and derating curves for appropriate maximum operating conditions
- Note 3: Forward voltage range is specified at a typical current drive condition and  $T_j = 85^\circ\text{C}$ .
- Note 4: CXM COB LEDs are designed for operation up to an absolute maximum forward drive current as specified above. Refer to the current vs. case temperature derating curves for further information.
- Note 5: Caution must be taken not to stare at the light emitted from these LEDs. Under special circumstances, the high intensity could damage the eye.

### CXM-6 Optical & Electrical Characteristics

Relative Output Flux vs. Forward Current @ 85°C

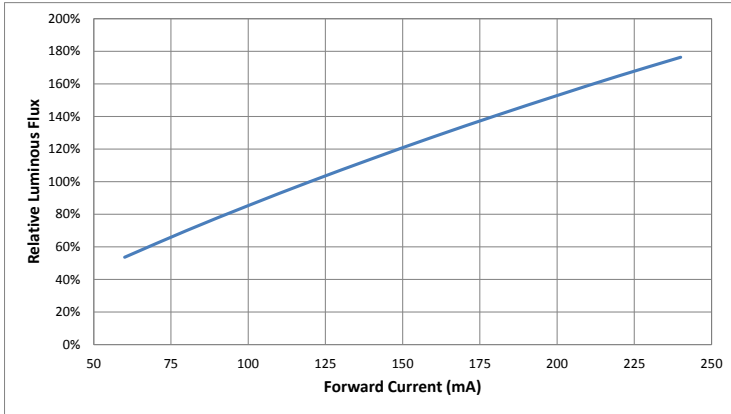

Forward Current vs. Forward Voltage @ 85°C

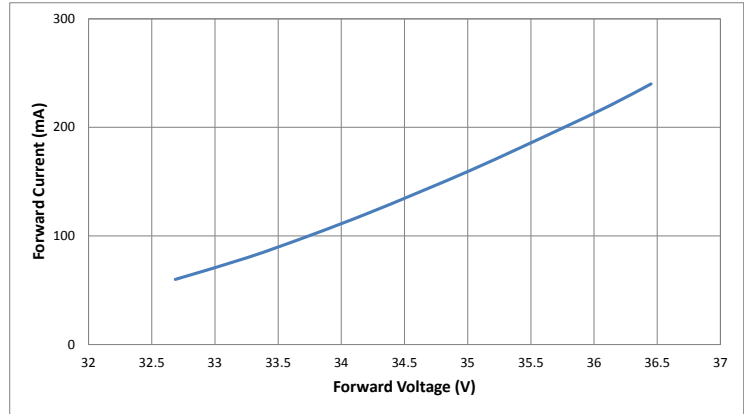

Relative Output Flux vs. Junction Temperature

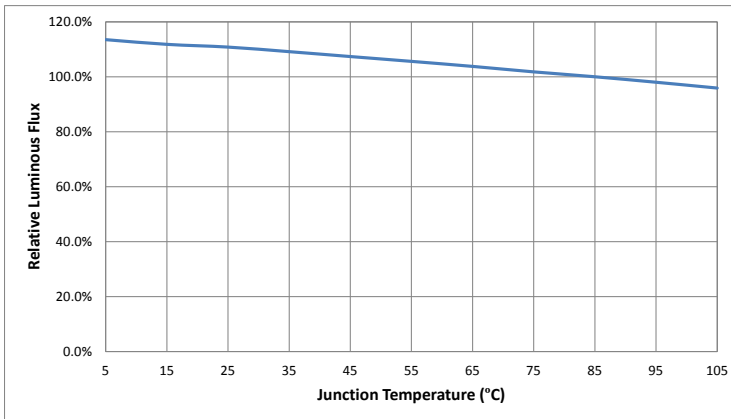

Change in Voltage vs. Junction Temperature

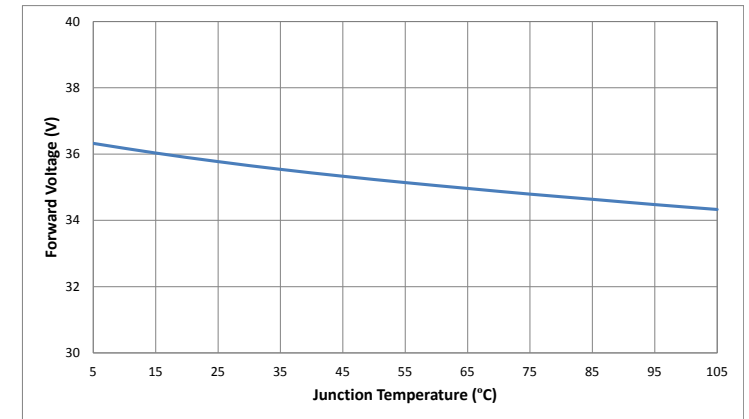

### CHM-6 , CXM-7, CLM-9 Optical & Electrical Characteristics

Relative Output Flux vs. Forward Current @ 85°C

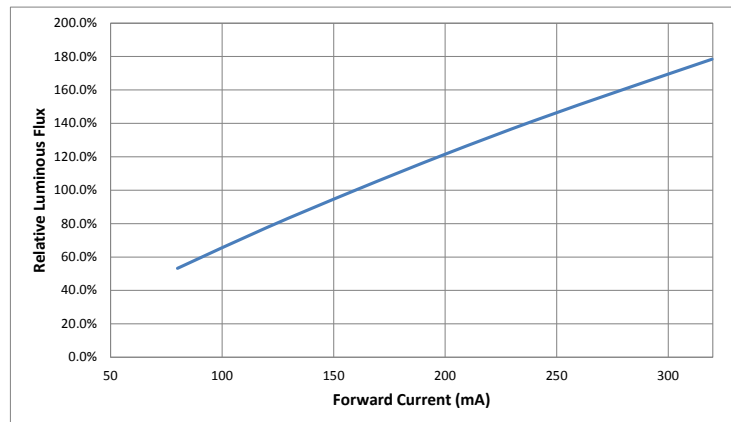

Forward Current vs. Forward Voltage @ 85°C

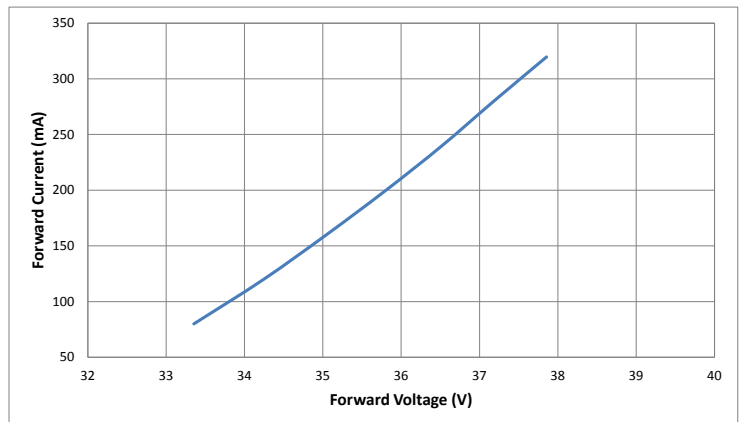

### CHM-6, CXM-7, CLM-9 Optical & Electrical Characteristics

**Relative Output Flux vs. Junction Temperature**

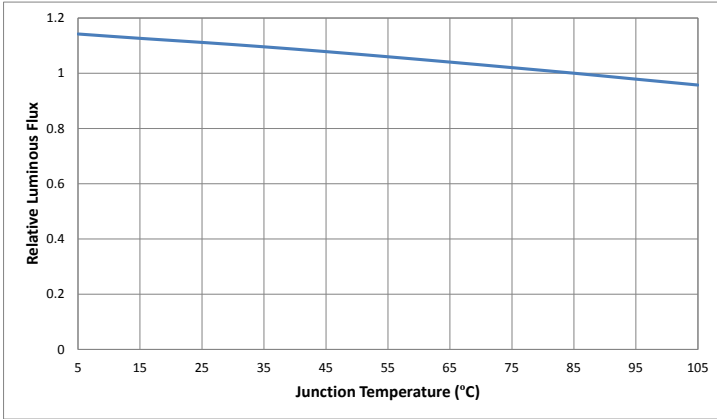

**Change in Voltage vs. Junction Temperature**

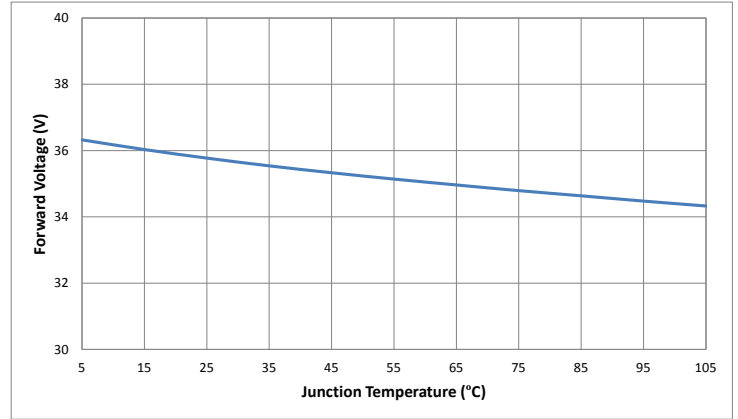

### CXM-9 Optical & Electrical Characteristics

**Relative Output Flux vs. Forward Current @ 85°C**

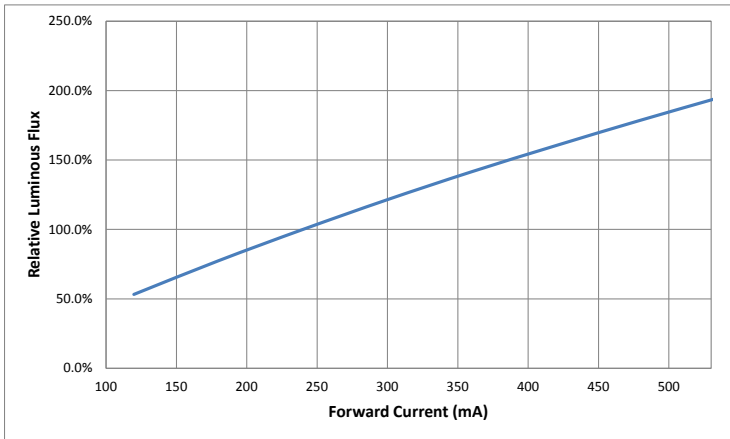

**Forward Current vs. Forward Voltage @ 85°C**

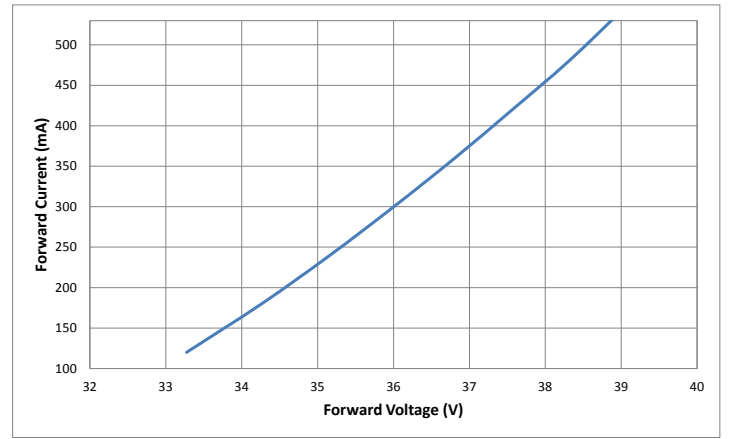

**Relative Output Flux vs. Junction Temperature**

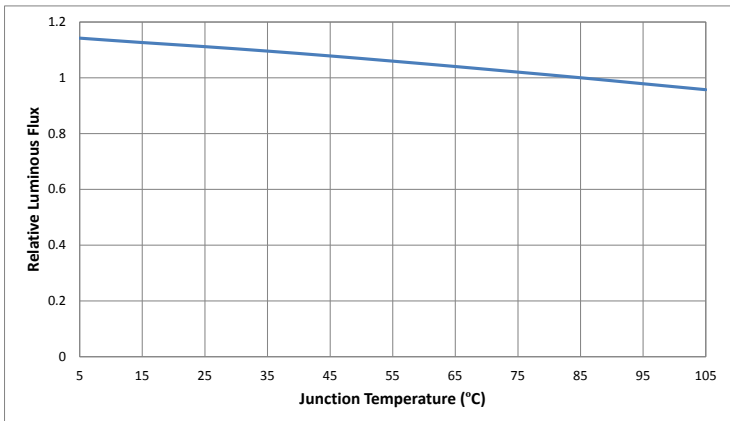

**Change in Voltage vs. Junction Temperature**

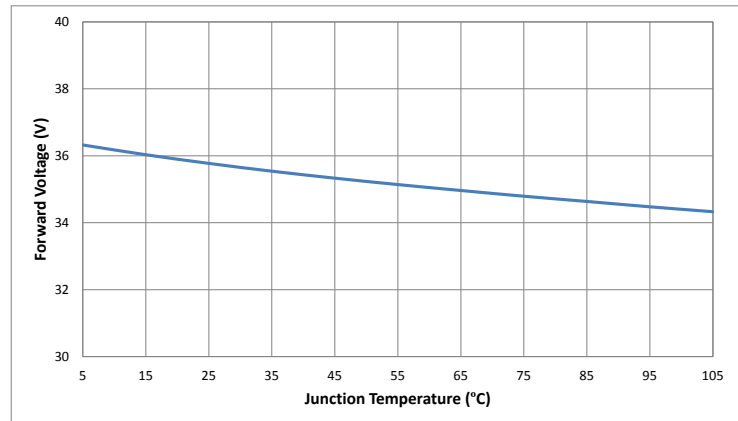

### CHM-9 Optical & Electrical Characteristics

**Relative Output Flux vs. Forward Current @ 85°C**

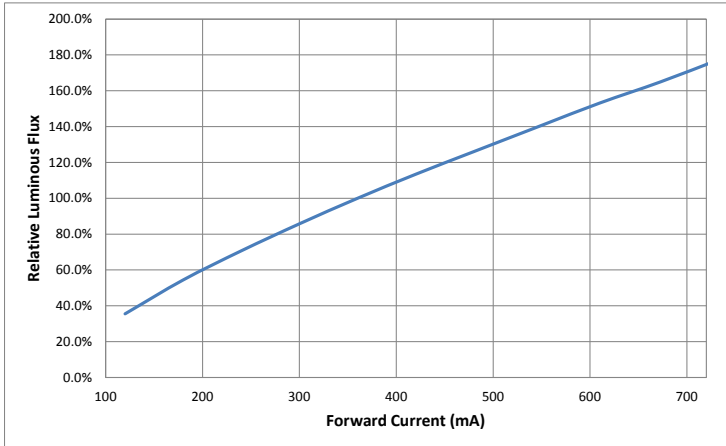

**Forward Current vs. Forward Voltage @ 85°C**

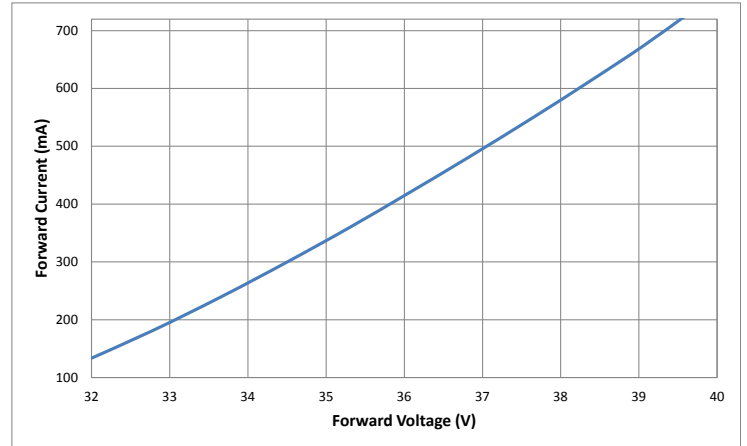

**Relative Output Flux vs. Junction Temperature**

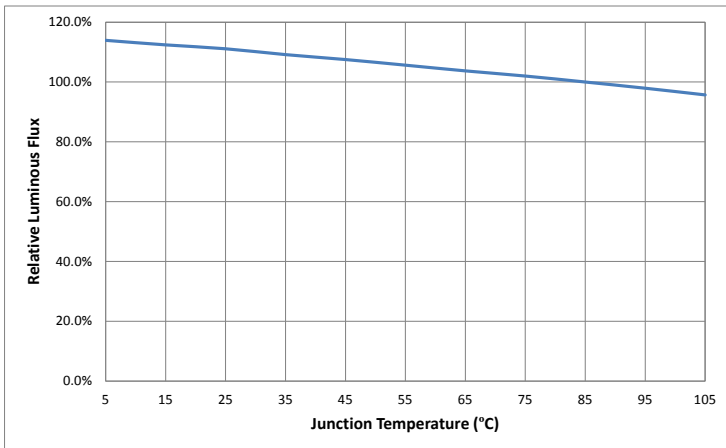

**Change in Voltage vs. Junction Temperature**

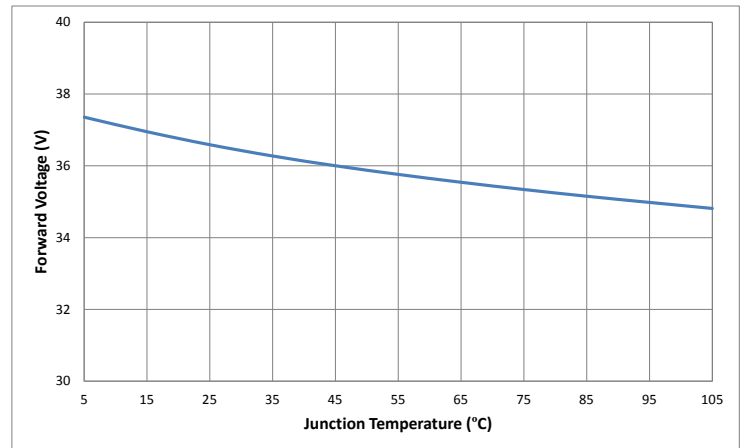

### CXM-14 Optical & Electrical Characteristics

**Relative Output Flux vs. Forward Current @ 85°C**

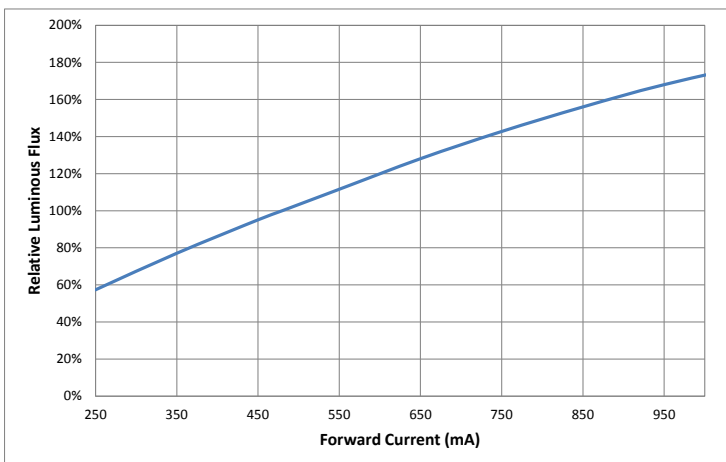

**Forward Current vs. Forward Voltage @ 85°C**

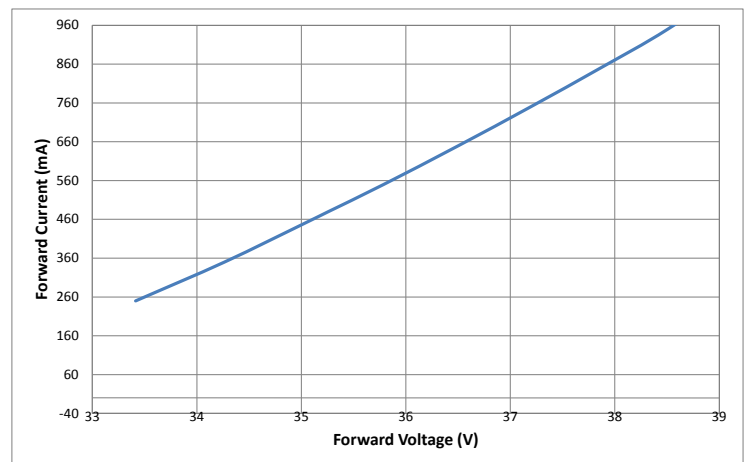

### CXM-14 Optical & Electrical Characteristics

Relative Output Flux vs. Junction Temperature

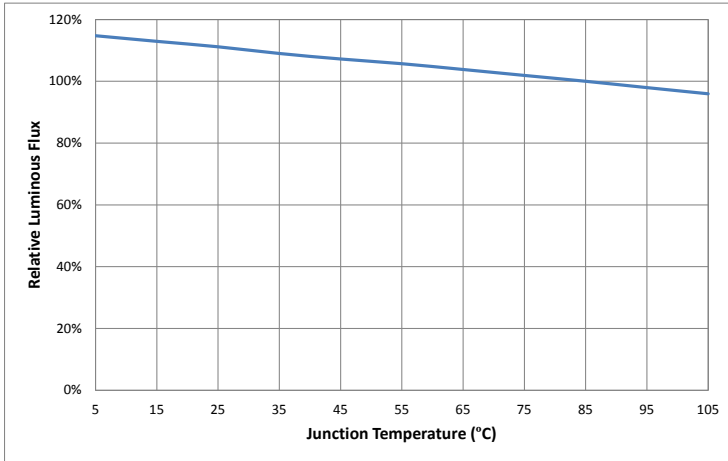

Change in Voltage vs. Junction Temperature

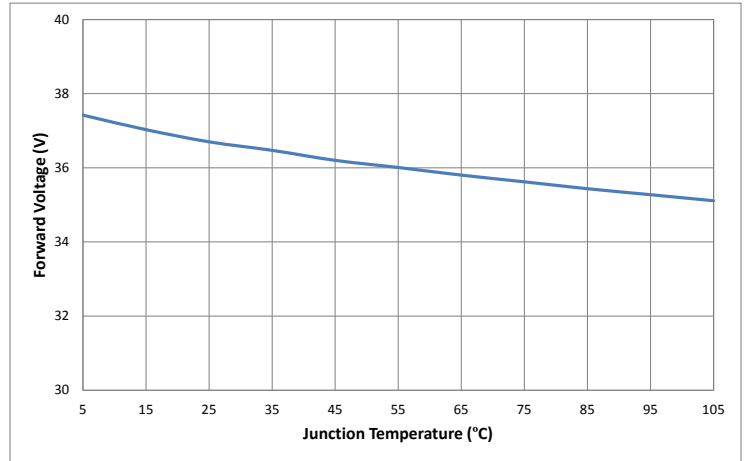

### CHM-14 Optical & Electrical Characteristics

Relative Output Flux vs. Forward Current @ 85°C

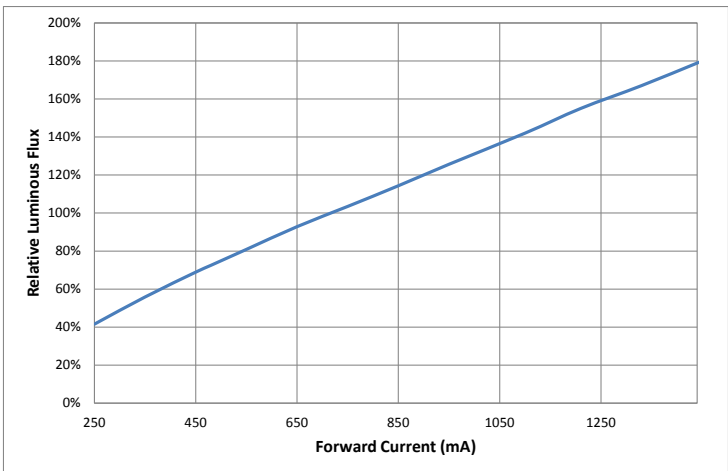

Forward Current vs. Forward Voltage @ 85°C

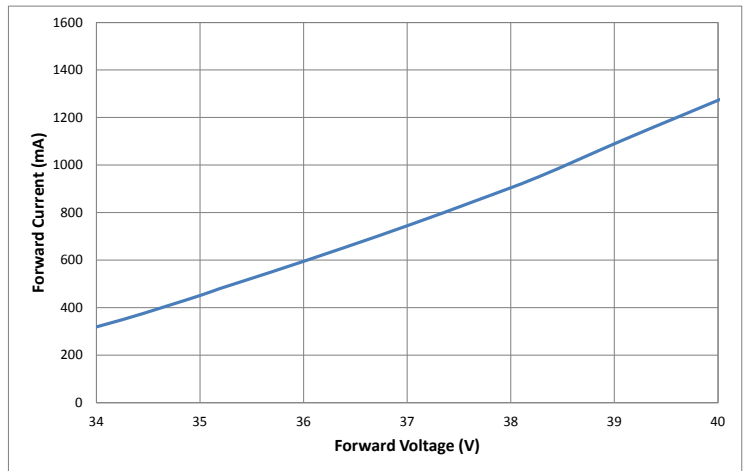

Relative Output Flux vs. Junction Temperature

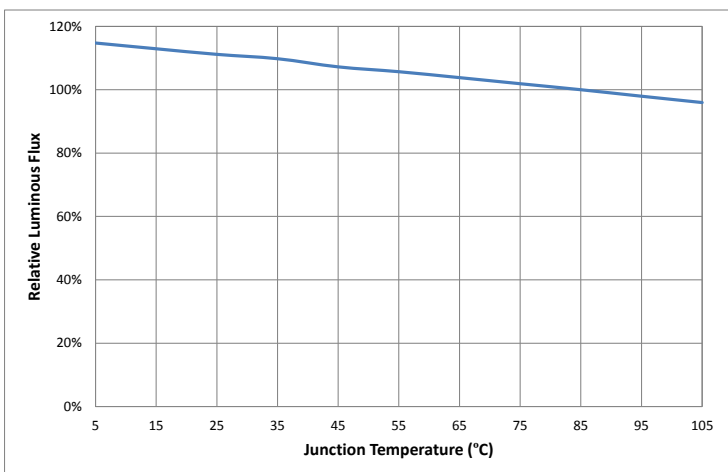

Change in Voltage vs. Junction Temperature

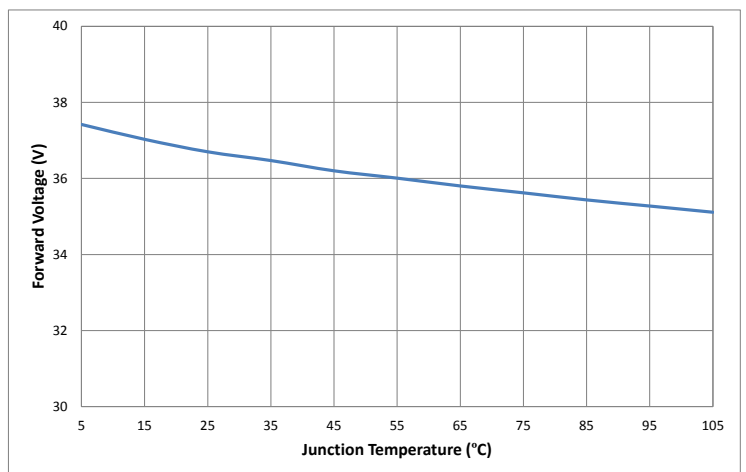

### CXM-18 Optical & Electrical Characteristics

Relative Output Flux vs. Forward Current @ 85°C

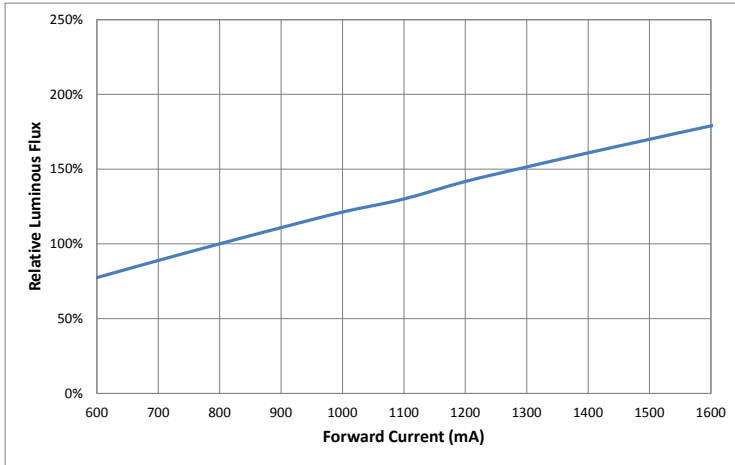

Forward Current vs. Forward Voltage @ 85°C

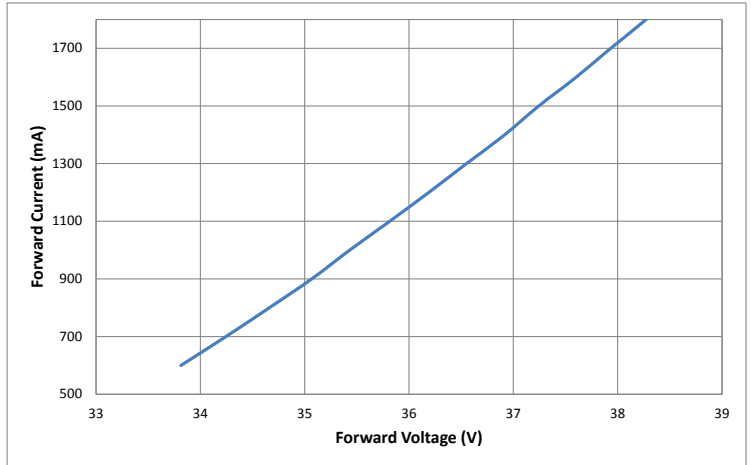

Relative Output Flux vs. Junction Temperature

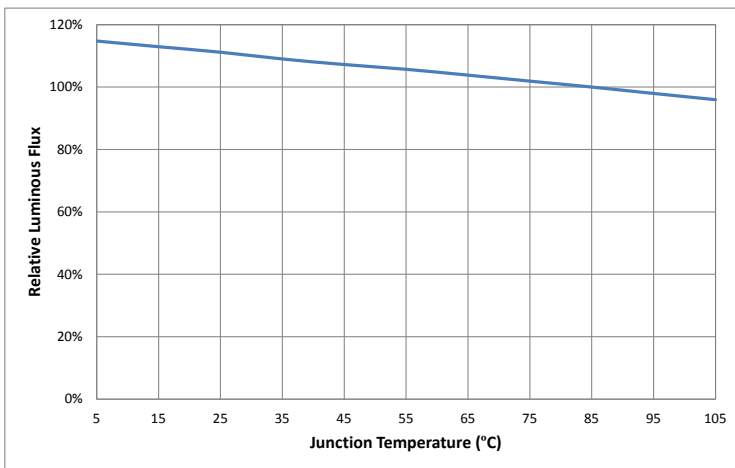

Change in Voltage vs. Junction Temperature

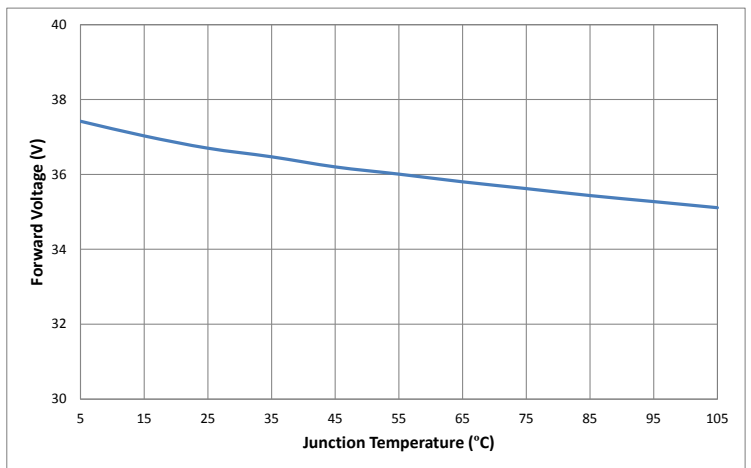

### CHM-18 Optical & Electrical Characteristics

Relative Output Flux vs. Forward Current @ 85°C

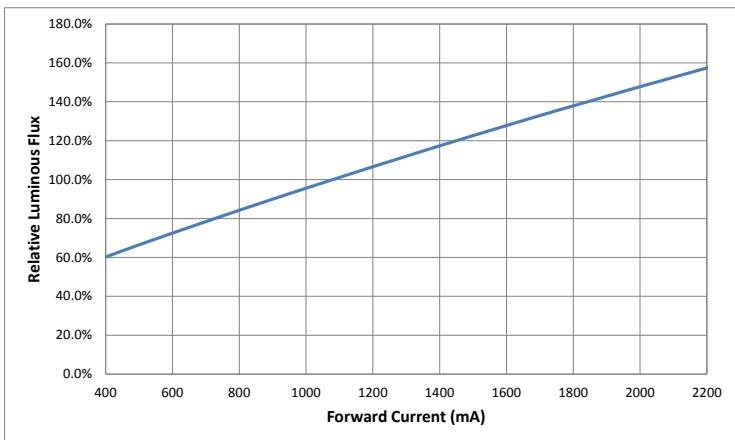

Forward Current vs. Forward Voltage @ 85°C

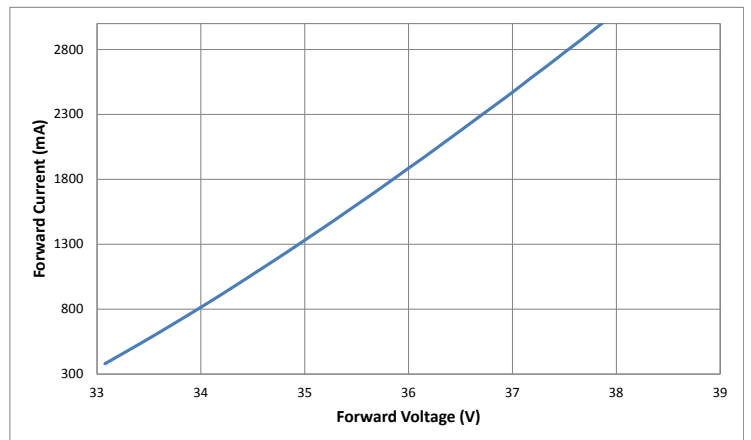



### CHM-18 Optical & Electrical Characteristics

Relative Output Flux vs. Junction Temperature

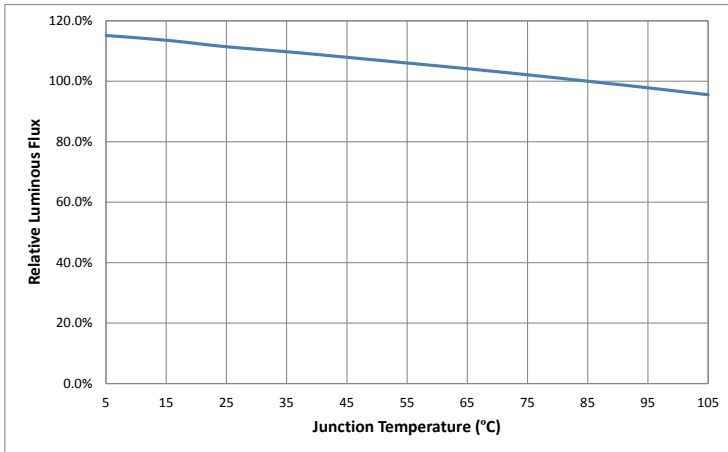

Change in Voltage vs. Junction Temperature

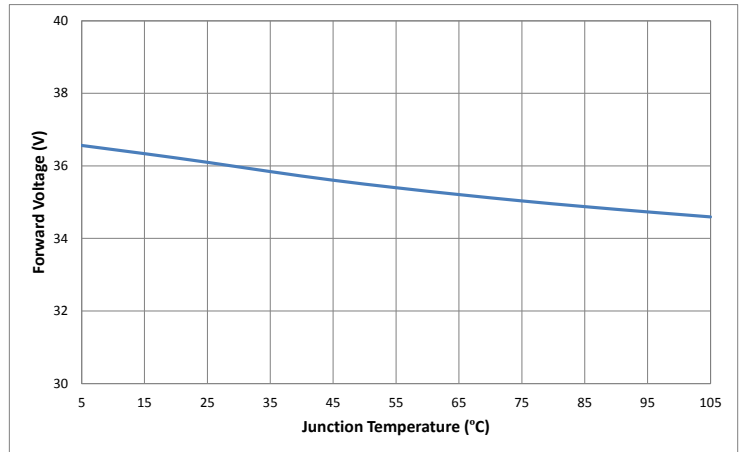

### CXM-22 Optical & Electrical Characteristics

Relative Output Flux vs. Forward Current @ 85°C

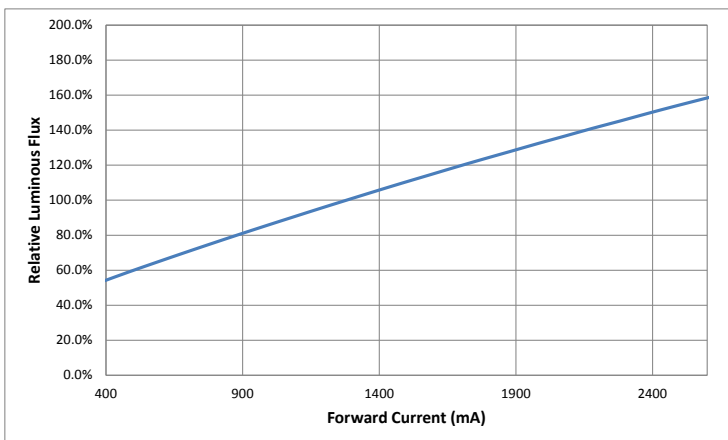

Forward Current vs. Forward Voltage @ 85°C

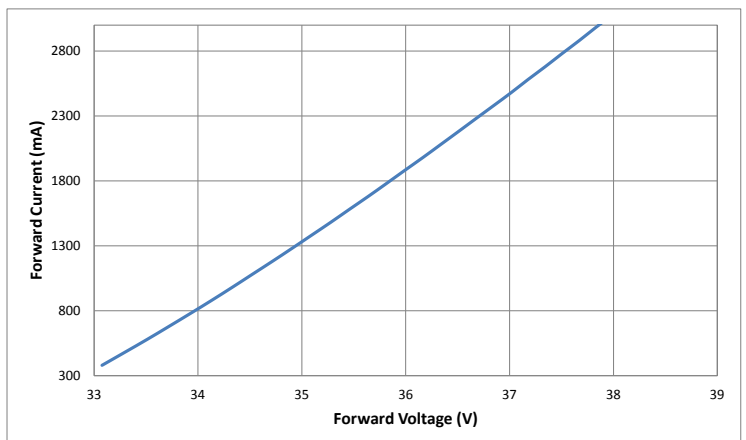

Relative Output Flux vs. Junction Temperature

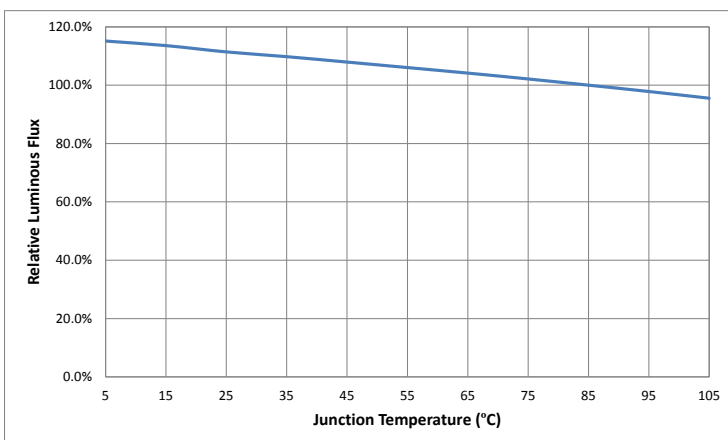

Change in Voltage vs. Junction Temperature

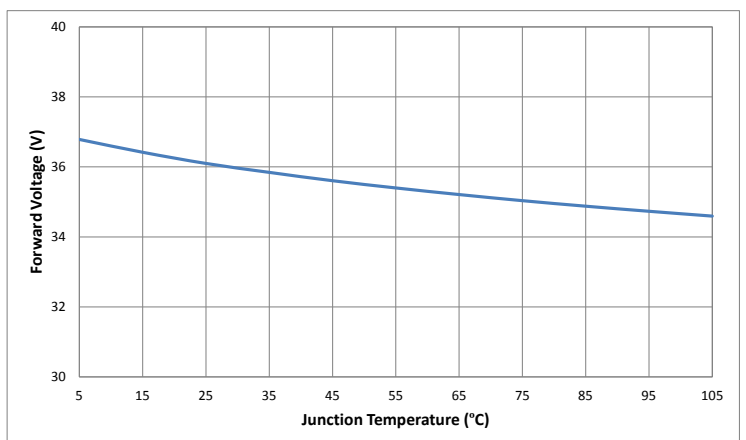

### CHM-22 Optical & Electrical Characteristics

#### Relative Output Flux vs. Forward Current @ 85°C

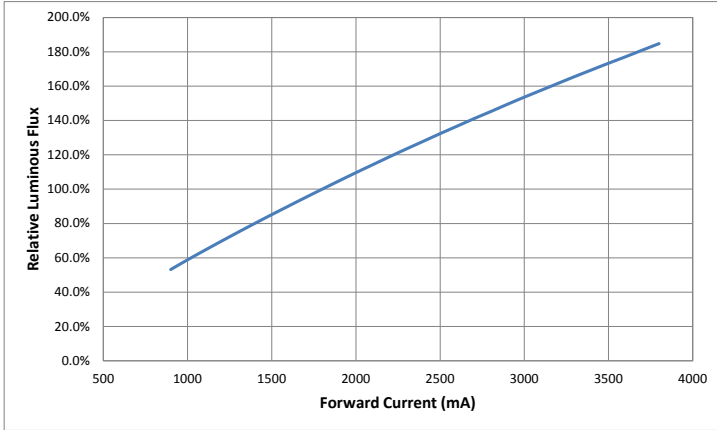

#### Forward Current vs. Forward Voltage @ 85°C

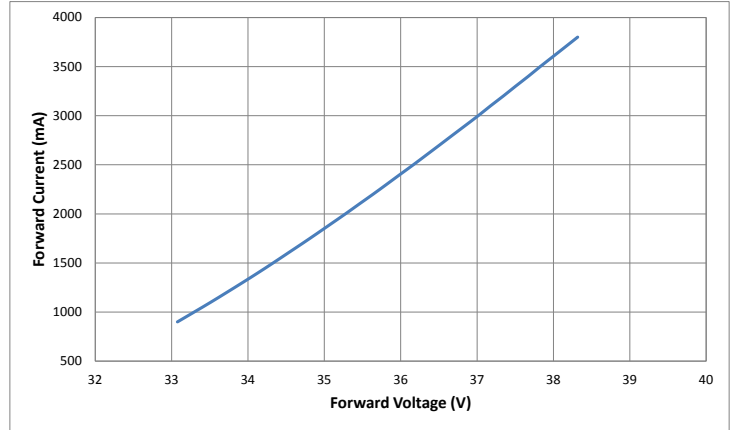

#### Relative Output Flux vs. Junction Temperature

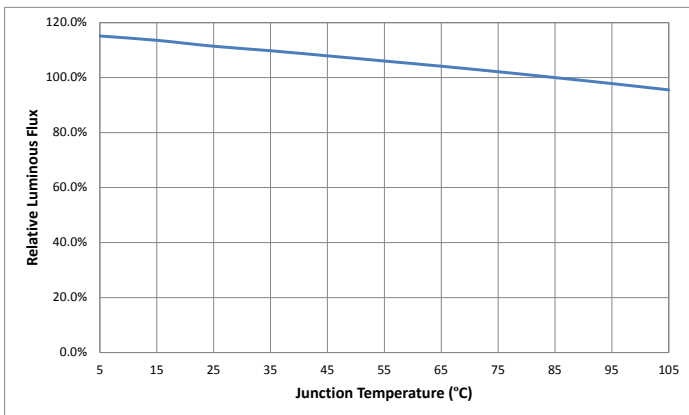

#### Change in Voltage vs. Junction Temperature

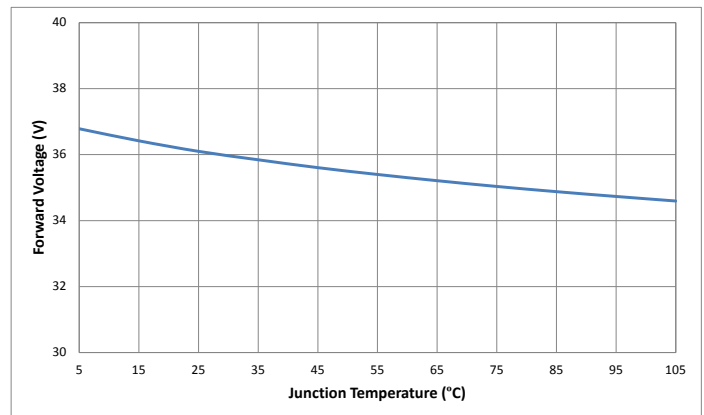

### Typical Spectrum

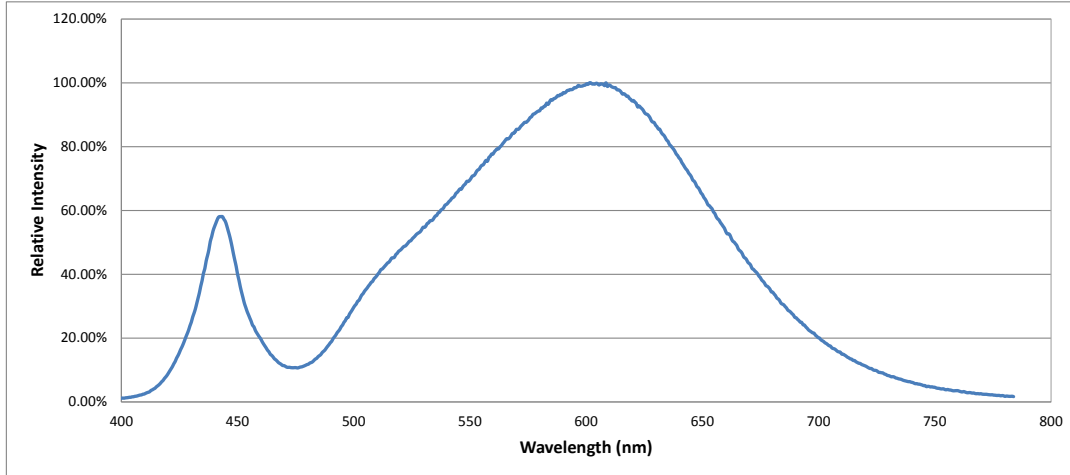

### Change CIE<sub>x</sub> vs. Junction Temperature (3000K, 80CRI)

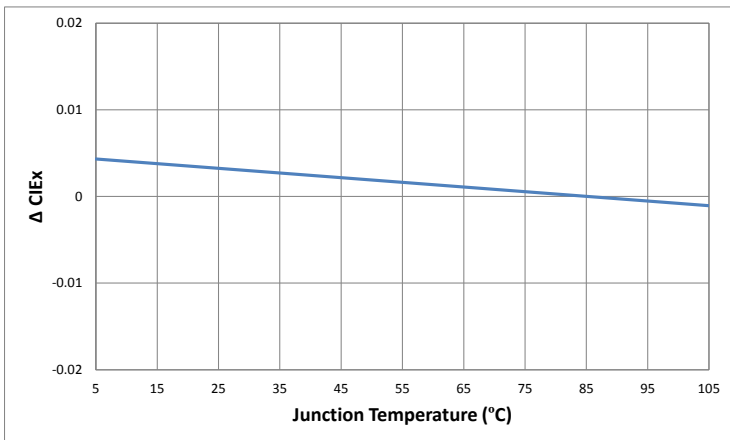

### Change CIE<sub>y</sub> vs. Junction Temperature (3000K, 80CRI)

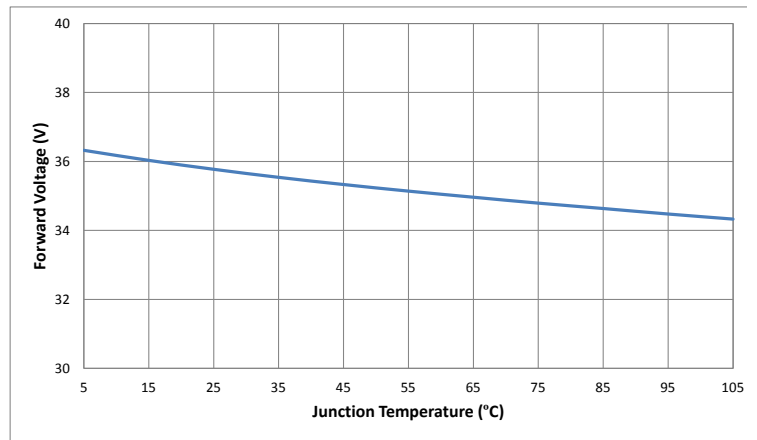

### Typical Polar Radiation Pattern

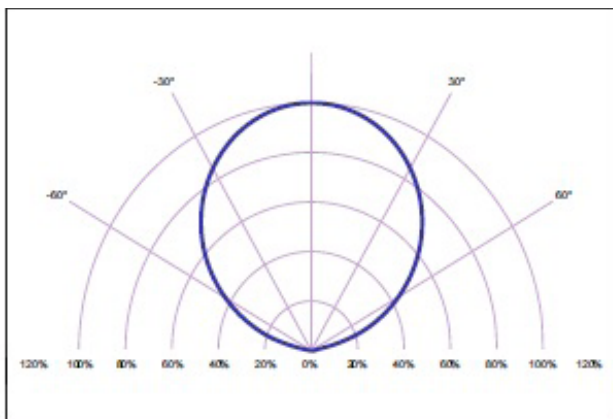

### Typical Angular Radiation Pattern

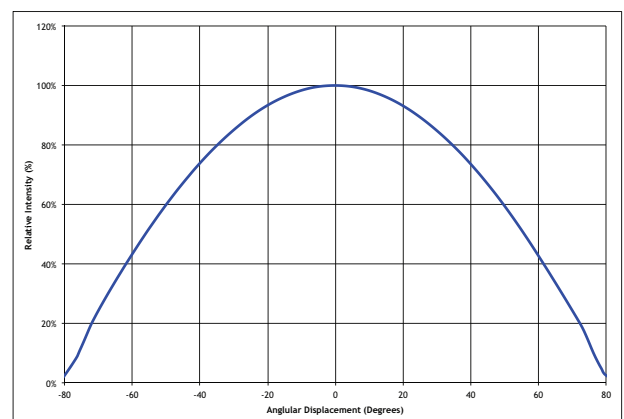

## Mechanical Dimensions, CXM-6

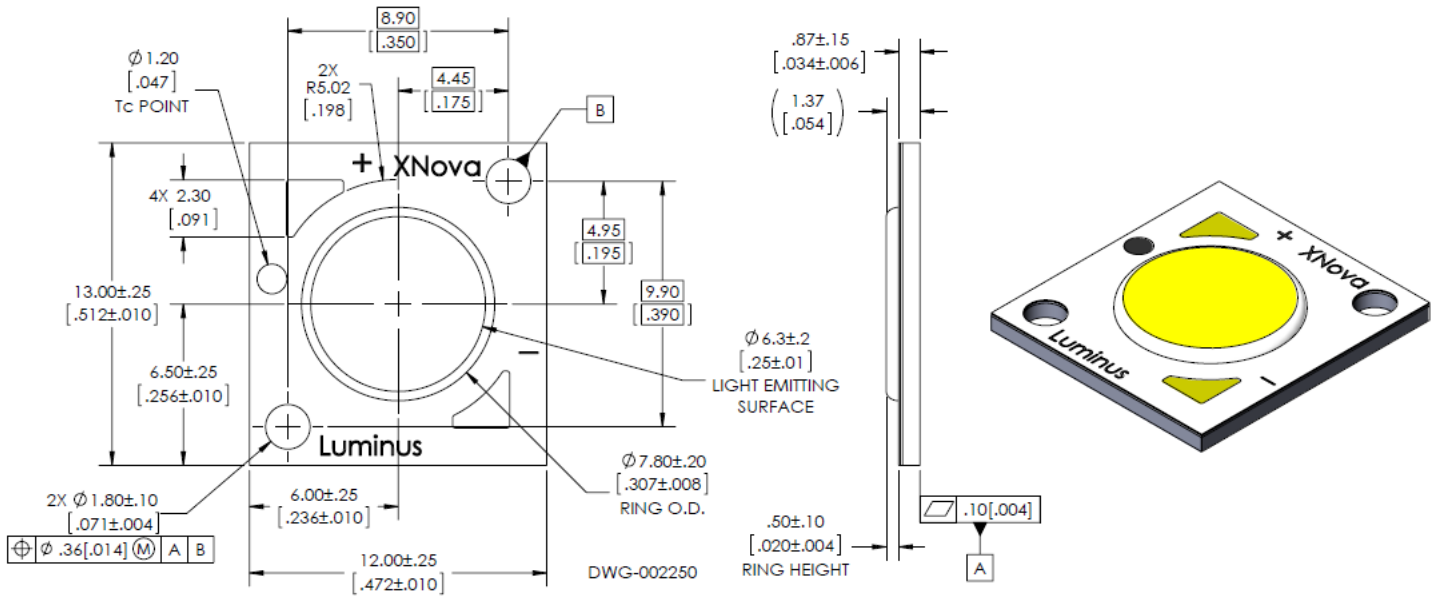

## Shipping Container, CXM-6

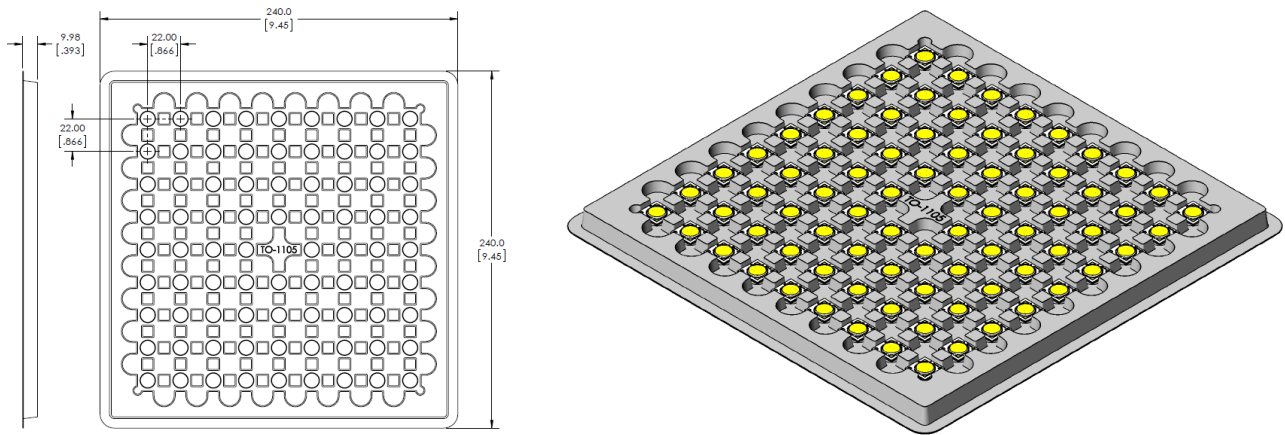

Each bag is boxed for easier storage/stacking

Trays are sealed in an anti-static bag

5 trays are stacked together with one tray as a cover

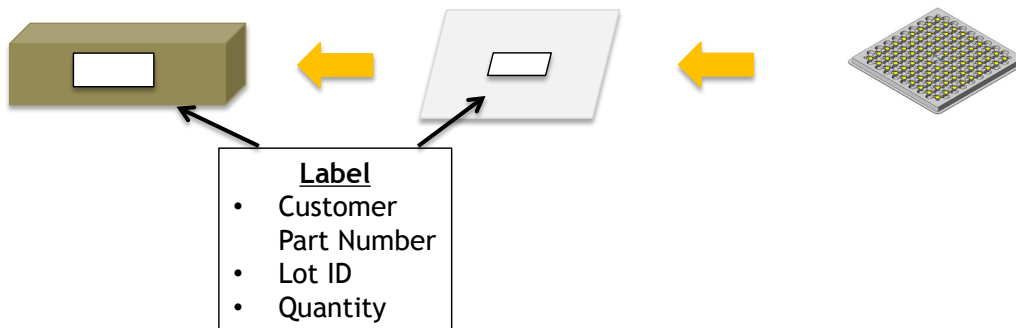

## Mechanical Dimensions, CXM-7

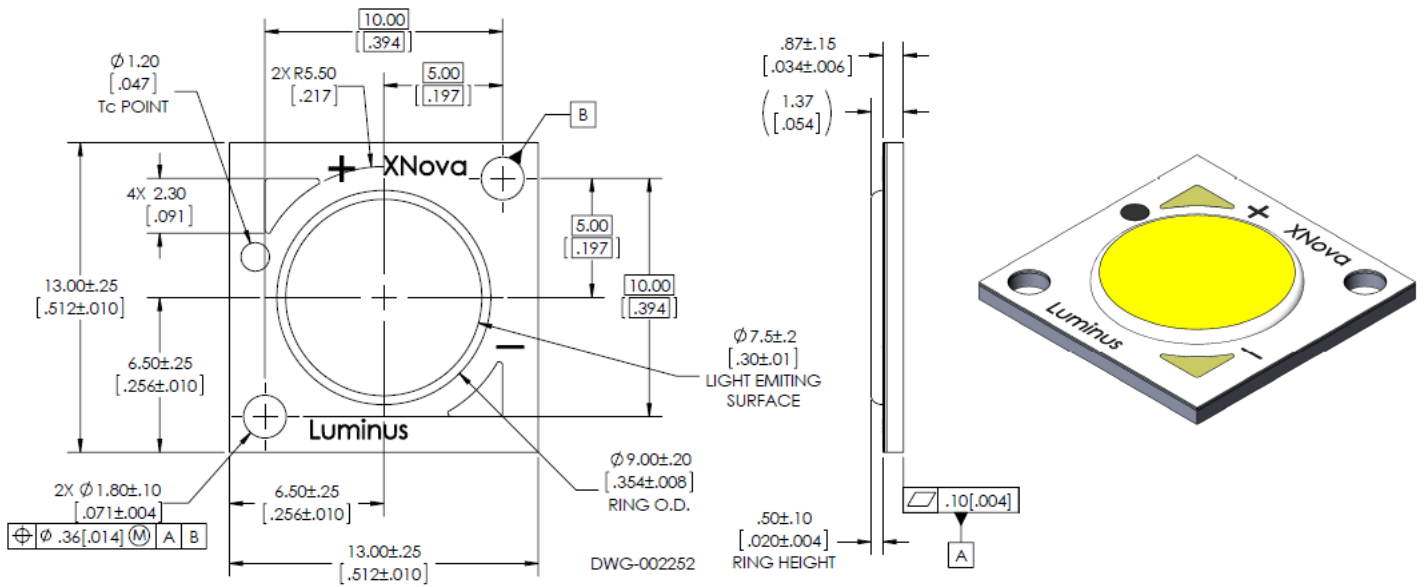

## Shipping Container, CXM-7

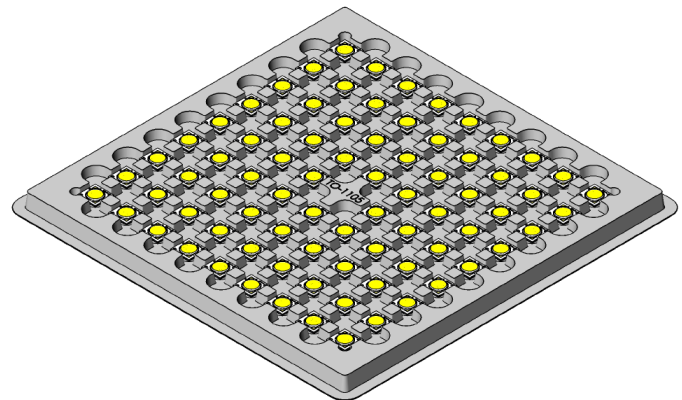
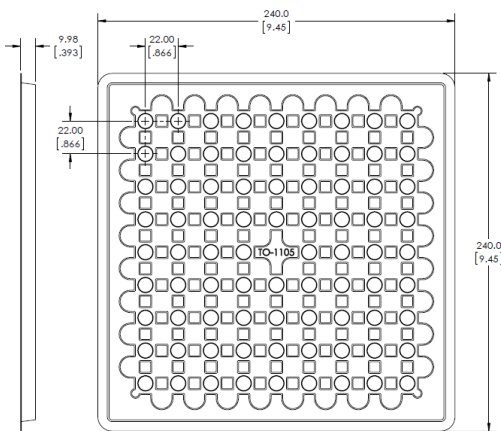

Each bag is boxed for easier storage/stacking

Trays are sealed in an anti-static bag

5 trays are stacked together with one tray as a cover

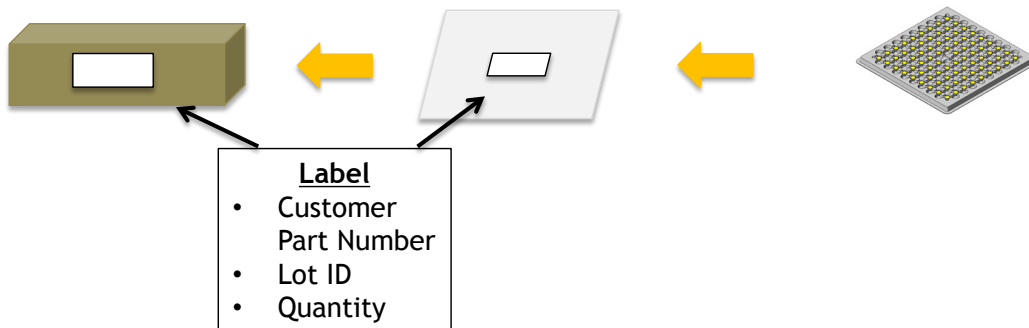

## Mechanical Dimensions, CXM-9 (AA00)

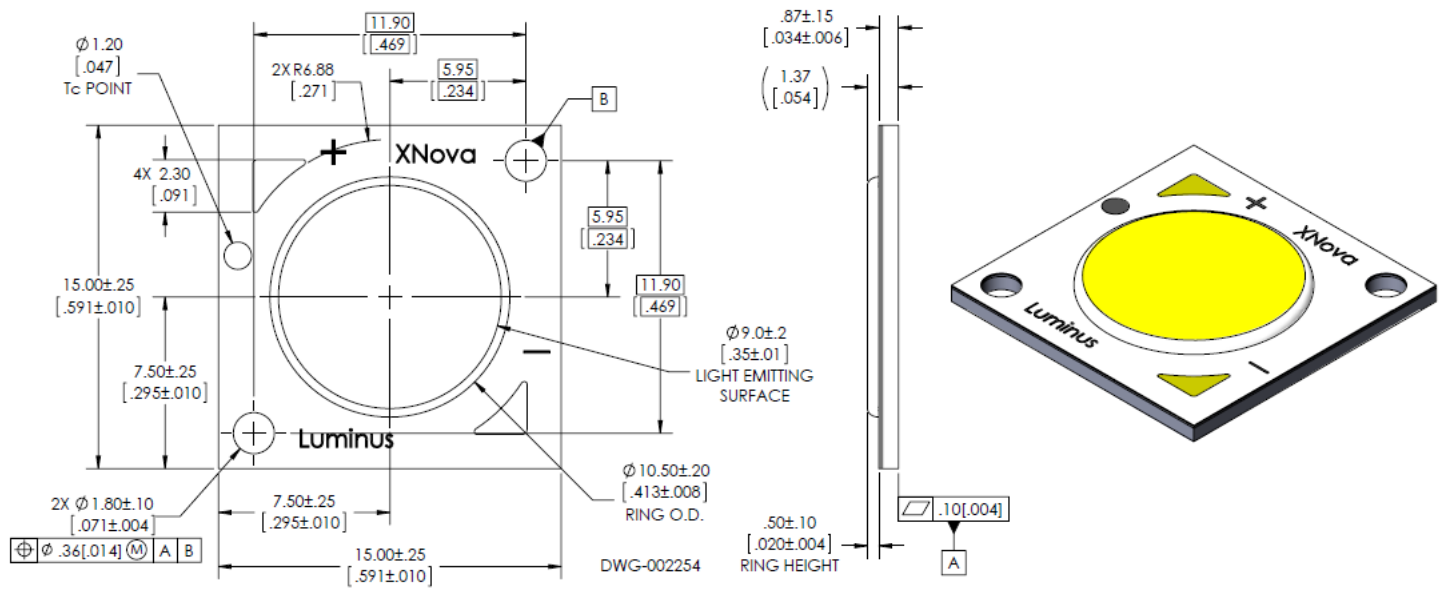

## Shipping Container, CXM-9 (AA00)

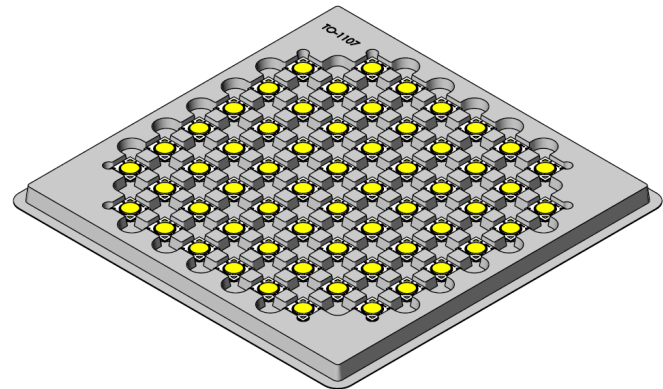
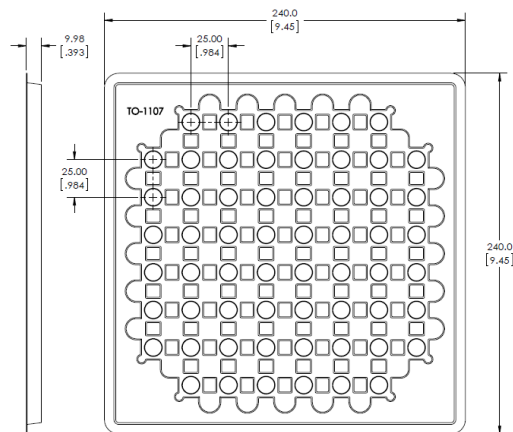

Each bag is boxed for easier storage/stacking

Trays are sealed in an anti-static bag

5 trays are stacked together with one tray as a cover

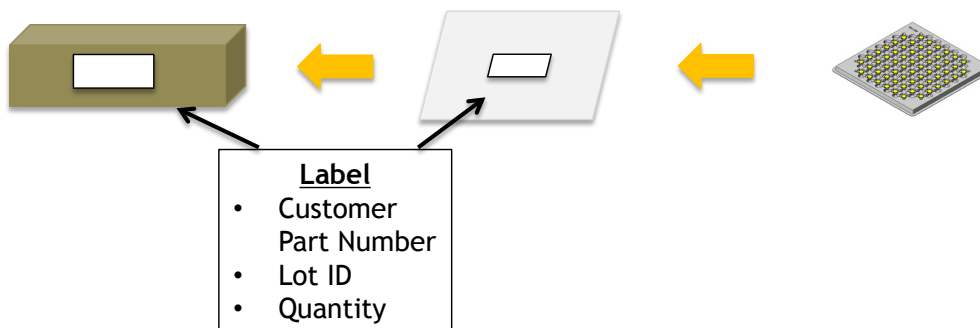

## Mechanical Dimensions, CLM/CXM/CHM-9 (AC00)

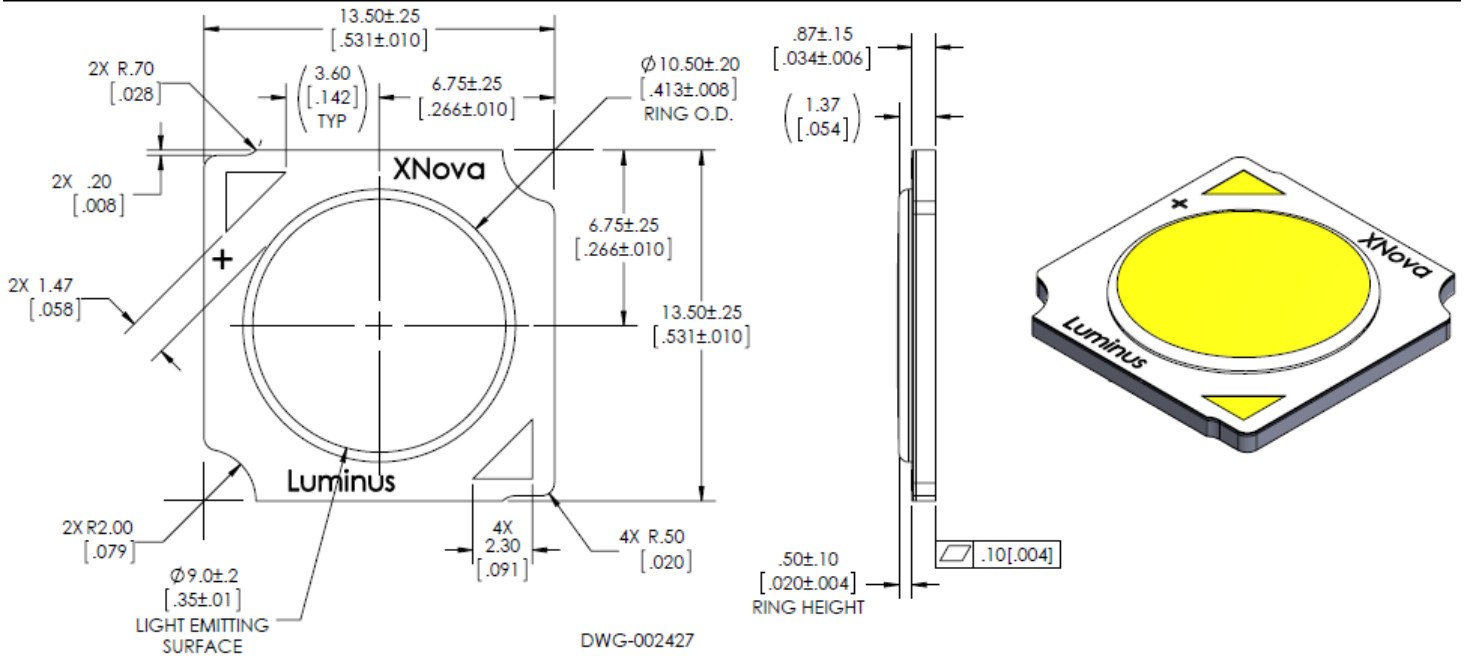

## Shipping Container, CLM/CXM/CHM-9 (AC00)

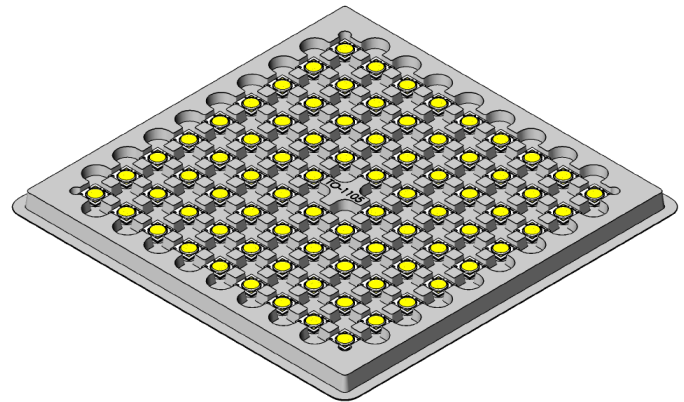
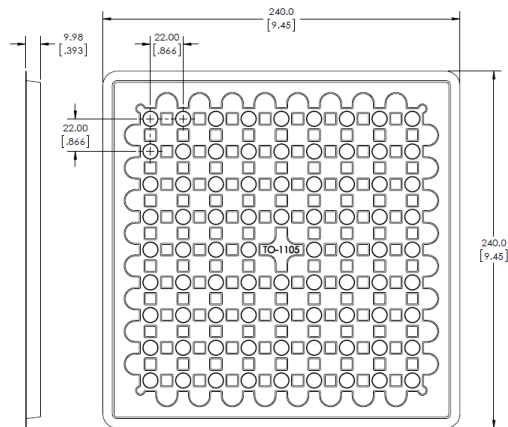

Each bag is boxed for easier storage/stacking

Trays are sealed in an anti-static bag

5 trays are stacked together with one tray as a cover

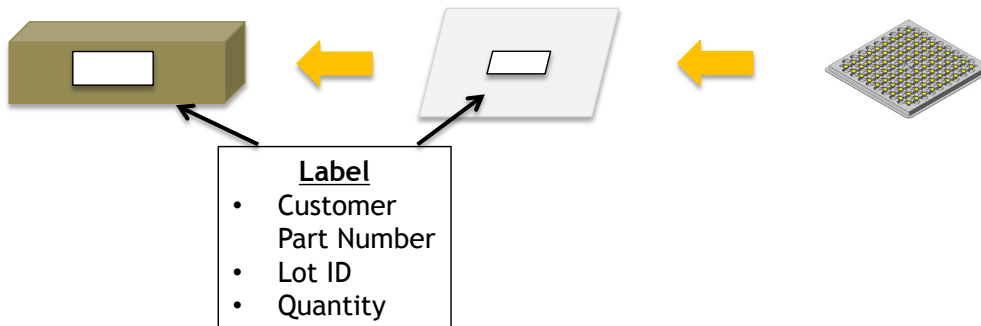





## Shipping Container, CXM/CHM-14 (AA00 and AC00)

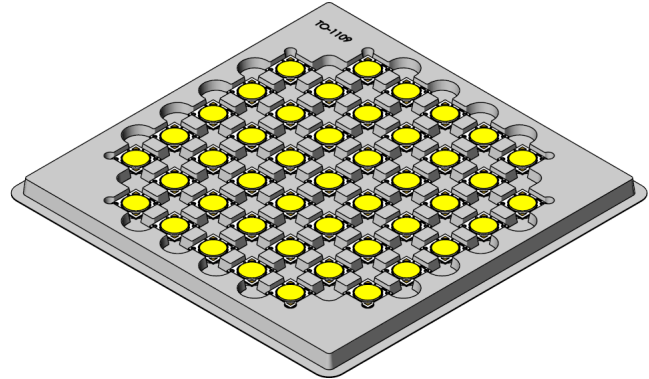
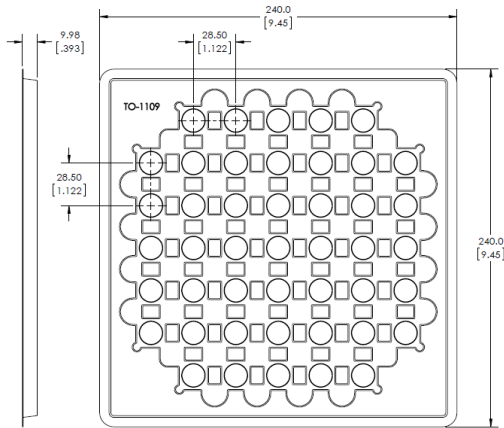

Each bag is boxed for easier storage/stacking

Trays are sealed in an anti-static bag

5 trays are stacked together with one tray as a cover

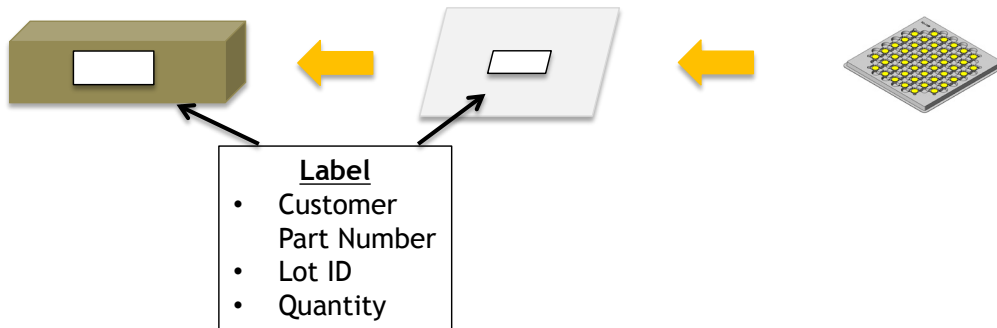



## Mechanical Dimensions, CXM/CHM-22

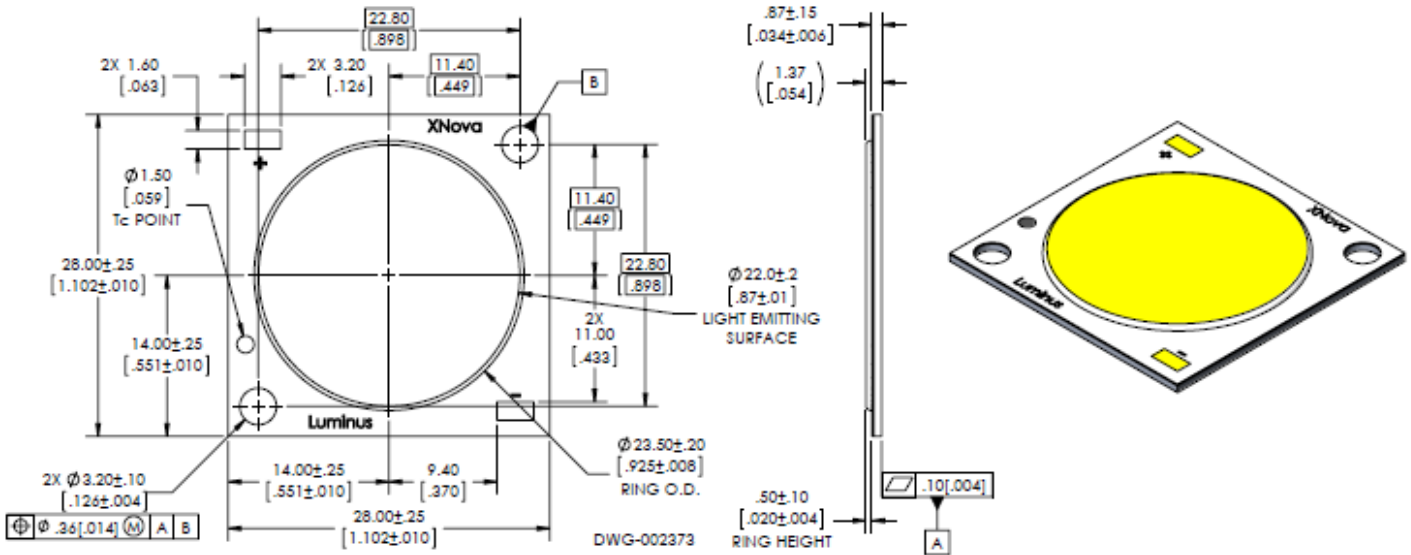

## Shipping Container, CXM/CHM-22

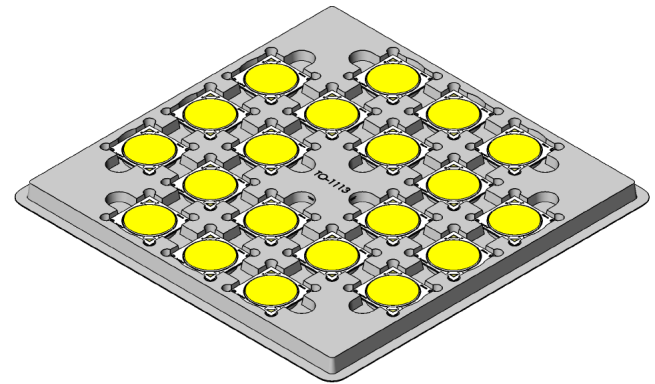
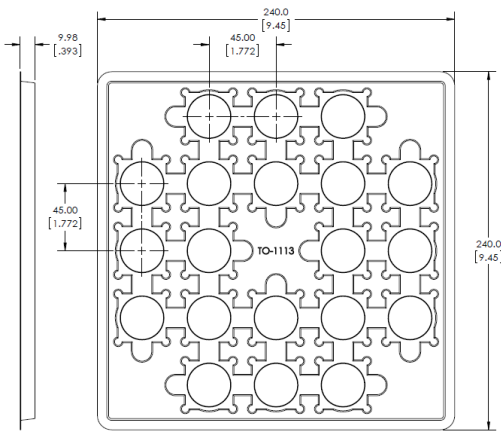

Each bag is boxed for easier storage/stacking

Trays are sealed in an anti-static bag

5 trays are stacked together with one tray as a cover

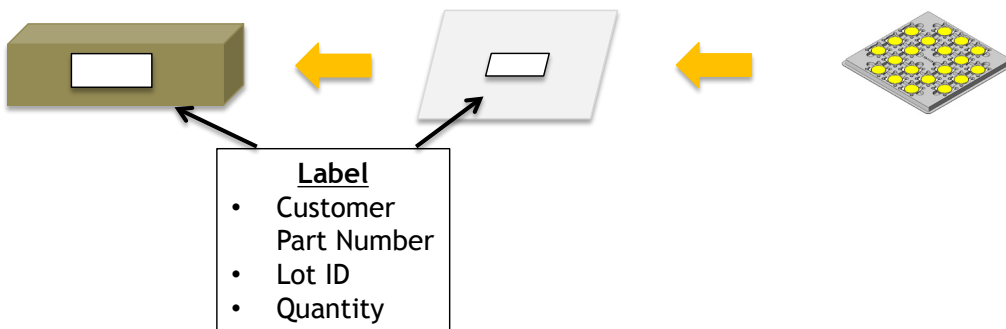

## Handling Notes for XNova COBs

XNova products are designed for robust performance in general lighting application. However, care must be taken when handling and assembling the LEDs into their fixtures. To avoid damaging XNova COBs please follow these guide lines.

The following is an overview of the application notes detailing some of the practices to follow when working with these devices. More detailed information is available on the Luminus web site at [www.luminus.com](http://www.luminus.com).

### General Handling

Devices are made to be lifted or carried with tweezers on two adjacent corners opposite the contact pads. At no time should the devices be handled by or should anything come in contact with the light emitting surface (LES) area. This area includes the yellow colored circular area and the ring surrounding it. There are electrical connections under the LES which if damaged will cause the device to fail.

In addition, the ring frame itself should not be used for moving, lifting or carrying the device. Also do not attach any optics or mechanical holders to the ring as it is not capable to handle the mechanical stress.

### Static Electricity

XNova COBs are electronic devices which can be damaged by electrostatic discharge (ESD). Please use appropriate measures to assure the devices do not experience ESD during their handling and or storage. ESD protection guidelines should be used at all times when working with XNova COBs.

**Storage:** XNova products are delivered in ESD shielded bags and should be stored in these bags until used.

**Assembly:** Individuals handling XNova COBs during assembly should be trained in ESD protection practices. Assemblers should maintain constant conductive contact with a path to ground by means of a wrist strap, ankle straps, mat or other ESD protection system.

**Transporting:** When transporting the devices from one assembly area to another, ESD shielded carts and carriers should be used.

### Electrical Contact

XNova COBs are designed with contact pads on their top surface. These pads are clearly marked with + and – polarity. Wires can be soldered to the contact pads for electrical connections or other solderless connector products are available.

If wires are being soldered to the COB product, we recommend attaching these wires prior to mounting the devices to a heat sink. Please contact Luminus for specific recommendations on how to solder wires if not familiar with the standard practice. Luminus can also offer design recommendations for jigs to allow easily soldering multiple products in rapid succession.

### Chemical Compatibility

The resin material used to form the LES can getter hydrocarbons from the surrounding environment. As a results, certain chemical compounds are not recommended for use with the XNova products. Use of these compounds can cause damage to the light output of the device and may permanently damage the device. Please refer to [www.luminus.com](http://www.luminus.com) for a list of the compounds not recommended for use with the XNova COB products.

### Thermal Interface Material (TIM)

Proper thermal management is critical for successful operation of any LED system. Excess operating temperature can reduce the light output of the device. And excessive heating can cause permanent damage to the device. Proper TIM material is a crucial component for effective heat transfer away from the LED during normal operation. Please refer to [www.luminus.com](http://www.luminus.com) for specific recommendations for TIM solutions.