

LOW PROFILE - P.C. BOARD MOUNT AUDIO TRANSFORMERS

- Pin type (0.25" length & 0.035" diameter), P.C. board mount
- Low profile, open type construction
- Frequency response 200 Hz. - 50 Khz. (+/- 2 db, ref. @ 1 Khz.)
- Net weight 0.6 oz.

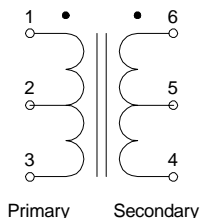

Cat. No.	Nominal Impedance		Max. Pri. D.C. ma	D.C. Resistance		Output Milliwatts
	Primary	Secondary		Primary	Secondary	
141B	200 K	1000	0	3775	85	4
141D	3000 ct	1000 ct	1	120	51	150
141F	25 K	50	2	1645	65	100
141H	600 ct	600 ct	2	32	45	150
141M	300 K	1200 ct	2	1100	47	100
141P	1200 ct	8	2	50	0.45	150

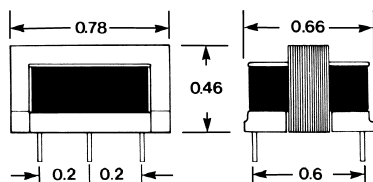

CHASSIS MOUNT - SHIELDED AUDIO TRANSFORMERS

- Insulated leads 5" long minimum
- Heavy drawn steel case (Diameter of 1.25" and height of 1") for excellent shielding - low hum pick-up.
- Frequency response 70 Hz. - 11 Khz. (+/- 1 db, ref. @ 1 Khz.)
- Case hole mounting centers are 1.6"
- Net weight 2 oz.

Cat. No.	Application	Nominal Impedance		Overall Turns Ratio Pri. to Sec.
		Primary	Secondary	
140A	Voice Coil to Single Grid	4	60000	1:122
140B	Dyn. MIC. to Single Grid	30	60000	1:45
140C	MIC. to Single Grid	50	60000	1:34.5
140H	Bridging Line to P.P. Grids	10000	40000 ct	1:2
140K	MIC. to Single Grid	150	60000	1:20
140M	CRYS, MIC. to Base	100K	1500	8:1
140N	Dyn. MIC to Base	50	1500	1:5.5
140P	Line to Base	150/600	600/2400	1:2
140Q	Line to Line	600 ct	600 ct	1:1



Audio

CANADA

Phone: (519) 822-2960 Fax: (519) 822-0715

USA

Phone: (716) 651-0086 Fax: (716) 651-0726



© 2000

**HAMMOND
MANUFACTURING™**
www.hammondmfg.com

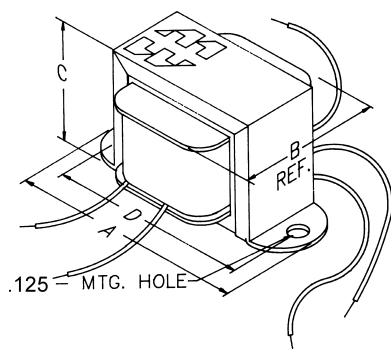

CHASSIS MOUNT AUDIO TRANSFORMERS

- Economical, open, two hole horizontal bracket mount.
- Insulated, color coded flexible leads, 4" long minimum (143, 144 & 145 Series) or 3" long minimum (146 Series).
- For a similar P.C. board mount version refer to our 148 & 149 Series.
- Frequency response 150 Hz. to 15 KHz. (+/- 1 db, reference 1000 Hz.)
- When operating at impedances below nominal, power capability and the frequency spectrum are proportionately lower, conversely, at higher impedances power capability and frequency spectrum will be proportionately higher.
- Net weight: 0.5 oz. (143, 144 Series) & 1.4 oz. (145 Series).

Series No.	Dimensions			
	A	B	C	D
143...	1.35	0.69	0.69	1.06
144...	1.35	0.69	0.69	1.06
145...	1.63	0.88	0.81	1.38
146...	1.63	0.88	0.81	1.38

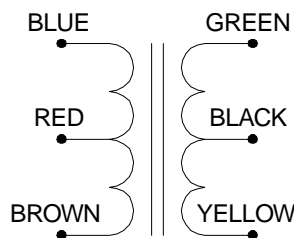
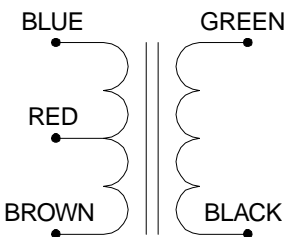
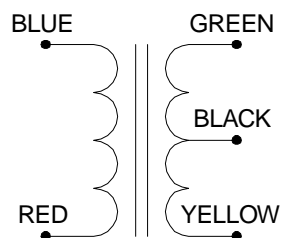
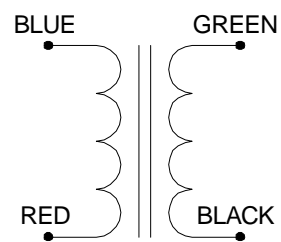

Cat. No.	Applicaton	Nominal Impedance		Pri. D.C. (*1) ma	D.C. Resistance +/- 15%		Output mW
		Primary	Secondary		Primary	Secondary	
143B	Input	3.2	4000	0	0.4	245	15
143D	Input	200K	1000	0	4500	30	25
143H	Driver	1500	500 ct	4	111	24	30
143J	Driver	3000	1000 ct	2.6	265	53	30
143L	Driver	10000	200 ct	1.5	720	9	30
143N	Driver	10000	2000 ct	1.5	720	89	30
143R	Driver	25000	600 ct	1	1890	25	30
144B	Output	200 ct	3.2	10	10	0.33	150
144D	Output	300 ct	3.2	9	15	0.33	150
144F	Output	500 ct	3.2	6	27	0.33	150
144G	Output	500 ct	8	6	27	0.9	150
144H	Output	500 ct	50	6	28	7.3	150
144I	Output	600 ct	150 ct	6	45	8.2	150
144P	Output	10000	3.2	5	575	0.5	50
144Q	Output	10000	8	5	575	0.9	50
144S	Output	20000	8	3.5	1240	0.9	50
145A	Driver	100	200 ct	45	14	19	100
145B	Driver-Output	600	600	18	30	38	200
145C	Input	50000	1500 ct	1	2400	52	50
145D	Input	200K	1000	0.5	3600	33	10
145E	Input-Output	600 ct	600 ct	5	65	83	200
145F	Driver	600 ct	200 ct	20	45	9	135
145G	Driver	2000	200 ct	12	140	9	135
145H	Driver	2000	500 ct	12	148	17	135
145J	Driver	4000	600 ct	8	340	24	135
145L	Driver	4000	2600 ct	8	340	100	135
145N	Driver	10000	2000 ct	5	700	89	135
145O	Driver	15000	200 ct	4	850	10	135
145P	Driver	20000	1000 ct	3.5	1180	50	135
145R	Driver	20000	2000 ct	3.5	1180	89	135
146B	Output	48 ct	3.2	20	2.4	0.3	700
146C	Output	48 ct	8	20	2.4	0.7	700
146D	Output	100 ct	3.2	14	4.4	0.3	700
146E	Output	100 ct	8	14	4.4	0.7	700
146F	Output	250 ct	3.2	8	11	0.3	700
146G	Output	250 ct	8	8	11	0.7	700
146H	Output	500 ct	3.2	6	26	0.3	700
146I	Output	500 ct	8	6	26	0.7	700
146J	Output	1000 ct	3.2	4	56	0.3	700
146K	Output	1000 ct	8	4	56	0.7	700
146N	Output	2000 ct	8	3	97	0.7	700
146S	Output	4000 ct	8	2	220	0.7	700

NOTES:

*1) For output transformers this figure is maximum unbalance.

Audio