



# Customer Process Guidelines

## AirPrime HL, WP, and RC Series Snap-in Socket



**SIERRA**  
WIRELESS®

4115102  
8.0  
February 24, 2021

## Important Notice

Due to the nature of wireless communications, transmission and reception of data can never be guaranteed. Data may be delayed, corrupted (i.e., have errors) or be totally lost. Although significant delays or losses of data are rare when wireless devices such as the Sierra Wireless modem are used in a normal manner with a well-constructed network, the Sierra Wireless modem should not be used in situations where failure to transmit or receive data could result in damage of any kind to the user or any other party, including but not limited to personal injury, death, or loss of property. Sierra Wireless accepts no responsibility for damages of any kind resulting from delays or errors in data transmitted or received using the Sierra Wireless modem, or for failure of the Sierra Wireless modem to transmit or receive such data.

## Safety and Hazards

Do not operate the Sierra Wireless modem in areas where cellular modems are not advised without proper device certifications. These areas include environments where cellular radio can interfere such as explosive atmospheres, medical equipment, or any other equipment which may be susceptible to any form of radio interference. The Sierra Wireless modem can transmit signals that could interfere with this equipment. Do not operate the Sierra Wireless modem in any aircraft, whether the aircraft is on the ground or in flight. In aircraft, the Sierra Wireless modem **MUST BE POWERED OFF**. When operating, the Sierra Wireless modem can transmit signals that could interfere with various onboard systems.

---

*Note: Some airlines may permit the use of cellular phones while the aircraft is on the ground and the door is open. Sierra Wireless modems may be used at this time.*

---

The driver or operator of any vehicle should not operate the Sierra Wireless modem while in control of a vehicle. Doing so will detract from the driver or operator's control and operation of that vehicle. In some states and provinces, operating such communications devices while in control of a vehicle is an offence.

## Limitations of Liability

This manual is provided "as is". Sierra Wireless makes no warranties of any kind, either expressed or implied, including any implied warranties of merchantability, fitness for a particular purpose, or noninfringement. The recipient of the manual shall endorse all risks arising from its use.

The information in this manual is subject to change without notice and does not represent a commitment on the part of Sierra Wireless. SIERRA WIRELESS AND ITS AFFILIATES SPECIFICALLY DISCLAIM LIABILITY FOR ANY AND ALL DIRECT, INDIRECT, SPECIAL, GENERAL, INCIDENTAL, CONSEQUENTIAL, PUNITIVE OR EXEMPLARY DAMAGES INCLUDING, BUT NOT LIMITED TO, LOSS OF PROFITS OR REVENUE OR ANTICIPATED PROFITS OR REVENUE ARISING OUT OF THE USE OR INABILITY TO USE ANY SIERRA WIRELESS PRODUCT, EVEN IF SIERRA WIRELESS AND/OR ITS AFFILIATES HAS BEEN ADVISED OF THE POSSIBILITY OF SUCH DAMAGES OR THEY ARE FORESEEABLE OR FOR CLAIMS BY ANY THIRD PARTY.

Notwithstanding the foregoing, in no event shall Sierra Wireless and/or its affiliates aggregate liability arising under or in connection with the Sierra Wireless product, regardless of the number of events, occurrences, or claims giving rise to liability, be in excess of the price paid by the purchaser for the Sierra Wireless product.

## Patents

This product may contain technology developed by or for Sierra Wireless Inc.

This product includes technology licensed from QUALCOMM®.

This product is manufactured or sold by Sierra Wireless Inc. or its affiliates under one or more patents licensed from InterDigital Group and MMP Portfolio Licensing.

## Copyright

© 2021 Sierra Wireless. All rights reserved.

## Trademarks

Sierra Wireless®, AirPrime®, AirLink®, AirVantage®, WISMO®, ALEOS® and the Sierra Wireless and Open AT logos are registered trademarks of Sierra Wireless, Inc. or one of its subsidiaries.

Watcher® is a registered trademark of NETGEAR, Inc., used under license.

Windows® and Windows Vista® are registered trademarks of Microsoft Corporation.

Macintosh® and Mac OS X® are registered trademarks of Apple Inc., registered in the U.S. and other countries.

QUALCOMM® is a registered trademark of QUALCOMM Incorporated. Used under license.

Other trademarks are the property of their respective owners.

## Contact Information

Sales information and technical support, including warranty and returns	Web: <a href="http://sierrawireless.com/company/contact-us/">sierrawireless.com/company/contact-us/</a> Global toll-free number: 1-877-687-7795 6:00 am to 6:00 pm PST
Corporate and product information	Web: <a href="http://sierrawireless.com">sierrawireless.com</a>

# Document History

Version	Date	Updates
1.0	February 19, 2014	Creation
1.1	February 21, 2014	Updated: <ul style="list-style-type: none"> <li>Figure 17 AirPrime Snap-in Socket Removal Tool</li> <li>Figure 18 Snap-in Socket Removal Tool</li> </ul>
2.0	December 03, 2014	Added: <ul style="list-style-type: none"> <li>2.6 Part Numbering Information</li> <li>6.1 Visual Inspection</li> </ul>
		Updated: <ul style="list-style-type: none"> <li>Figure 5 AirPrime Snap-in Socket Cover Delivered in Tray</li> <li>5.1 Stencil Design</li> <li>Instances of “pin 1” to “polarity mark”</li> </ul>
3.0	June 05, 2015	Added: <ul style="list-style-type: none"> <li>Support for WP Series of Embedded Modules</li> <li>Number of insertions in section 6.3 Removal Guidelines</li> </ul>
3.1	June 10, 2015	Updated: <ul style="list-style-type: none"> <li>Figure 9 Recommended WP and RC76 Series Snap-in Socket Footprint – Copper Layout</li> <li>4.2.3 Layout Recommendations</li> <li>Figure 12 Recommended HL Series Snap-in Socket Footprint – Paste Mask Layout</li> </ul>
4.0	March 15, 2016	Updated: <ul style="list-style-type: none"> <li>2.6 Part Numbering Information</li> <li>3.2 Component Package</li> <li>4.2.3 Layout Recommendations</li> <li>5.3 Solder Reflow Profile</li> </ul>
4.1	April 07, 2016	Updated 2.6 Part Numbering Information
5.0	June 21, 2016	Added support for HL6528RDx, HL7528, HL7538, HL7539, HL7549, HL7618, HL7648, HL7688, HL7690 and WP75xx
		Updated: <ul style="list-style-type: none"> <li>Figure 6 Recommended HL Series Snap-in Socket Footprint – Copper Layout Position</li> <li>Figure 8 Recommended WP and RC76 Series Snap-in Socket Footprint – Copper Layout Position</li> </ul>
6.0	June 15, 2017	Updated: <ul style="list-style-type: none"> <li>1.2 Reference Documents</li> <li>2.6 Part Numbering Information</li> <li>3.2 Component Package</li> <li>Figure 8 Recommended WP and RC76 Series Snap-in Socket Footprint – Copper Layout Position</li> <li>6.3 Removal Guidelines</li> </ul>
7.0	December 2020	Updated: <ul style="list-style-type: none"> <li>Added the RC series</li> </ul>
8.0	February 24, 2021	Updated: <ul style="list-style-type: none"> <li>Added RC76 in Compatible Module Series</li> </ul>



# Contents

<b>1. INTRODUCTION .....</b>	<b>7</b>
1.1. Overview.....	7
1.2. Reference Documents.....	7
<b>2. SNAP-IN SOCKET CHARACTERISTICS .....</b>	<b>9</b>
2.1. Storage Temperature Range.....	9
2.2. Operating Temperature Range .....	9
2.3. Standard Atmospheric Condition.....	9
2.4. Electrical Characteristics .....	9
2.5. Mechanical Characteristics .....	10
2.6. Part Numbering Information .....	10
<b>3. HANDLING .....</b>	<b>11</b>
3.1. Storage of the AirPrime Snap-in Socket.....	11
3.2. Component Package.....	11
3.3. Component Packing .....	13
<b>4. SMT ASSEMBLY PROCESS .....</b>	<b>14</b>
4.1. Lead-Free Process.....	14
4.2. PCB Design Requirements .....	14
4.2.1. PCB Surface Finish.....	14
4.2.2. Footprint .....	14
4.2.3. Layout Recommendations .....	19
4.3. Solder Mask.....	19
<b>5. BOARD MOUNTING GUIDELINES .....</b>	<b>22</b>
5.1. Stencil Design.....	22
5.2. SMT Process Parameters .....	25
5.3. Solder Reflow Profile.....	25
<b>6. INSERTION AND REMOVAL GUIDELINES .....</b>	<b>27</b>
6.1. Visual Inspection .....	27
6.2. Insertion Guideline.....	27
6.3. Removal Guidelines .....	29
6.4. AirPrime Snap-in Socket Damage Prevention .....	30
6.4.1. Socket .....	30
6.4.2. Cover.....	30



## List of Figures

Figure 1.	AirPrime Snap-in Socket .....	11
Figure 2.	Sectional View of the 2.5 mm thick module Socket .....	12
Figure 3.	Sectional view of the 4.4 mm thick module Socket .....	12
Figure 4.	AirPrime Snap-in Socket Frame Delivered in Tape and Reel.....	13
Figure 5.	AirPrime Snap-in Socket Cover Delivered in Tray .....	13
Figure 6.	Recommended HL Series Snap-in Socket Footprint – Copper Layout Position.....	15
Figure 7.	Recommended HL Series Snap-in Socket Footprint – Copper Layout.....	16
Figure 8.	Recommended WP and RC76 Series Snap-in Socket Footprint – Copper Layout Position .....	17
Figure 9.	Recommended WP and RC76 Series Snap-in Socket Footprint – Copper Layout.....	18
Figure 10.	Recommended HL Series Snap-in Socket Footprint – Solder Mask Layout .....	20
Figure 11.	Recommended WP and RC76 Series Snap-in Socket Footprint – Solder Mask Layout	21
Figure 12.	Recommended HL Series Snap-in Socket Footprint – Paste Mask Layout .....	23
Figure 13.	Recommended WP and RC76 Series Snap-in Socket Footprint – Paste Mask Layout .	24
Figure 14.	Pick & Place Area.....	25
Figure 15.	Recommended Reflow Profile.....	25
Figure 16.	Example of Bent Contacts.....	27
Figure 17.	AirPrime Snap-in Socket Removal Tool.....	29
Figure 18.	Snap-in Socket Removal Tool.....	29
Figure 19.	Socket Contacts and Heat Sink Legs Location .....	30



# 1. Introduction

## 1.1. Overview

The AirPrime Snap-in socket is available for all variants of AirPrime modules compatible with the new COMMON FLEXIBLE FORM FACTOR (CF3™). It has been specified and tested to preserve the high level of performance and reliability of the AirPrime module used inside. As a result, the AirPrime Snap-in socket can be used for test purposes, to ease development, as well as for volume production.

This document presents guidelines for the industrial assembly of the AirPrime Snap-in Socket on an application.

## 1.2. Reference Documents

---

*Note: The list of AirPrime HL and WP modules below may be not exhaustive; this document is applicable to all AirPrime HL and WP variants.*

---

- [1] AirPrime HL3450 Product Technical Specification  
Reference number: 4117500
- [2] AirPrime HL6528x Product Technical Specification  
Reference number: 4114016
- [3] AirPrime HL6528RDx Product Technical Specification  
Reference number: 4117701
- [4] AirPrime HL7518 Product Technical Specification  
Reference number: 4115834
- [5] AirPrime HL7518RD Product Technical Specification  
Reference number: TBD
- [6] AirPrime HL7528 Product Technical Specification  
Reference number: 4116873
- [7] AirPrime HL7538 Product Technical Specification  
Reference number: 411
- [8] AirPrime HL7539 Product Technical Specification  
Reference number: 4118584
- [9] AirPrime HL7548 and HL7588 Product Technical Specification  
Reference number: 4116369
- [10] AirPrime HL7549 Product Technical Specification  
Reference number: 4117459
- [11] AirPrime HL7618 Product Technical Specification  
Reference number: 4117929
- [12] AirPrime HL7648 Product Technical Specification  
Reference number: 4119069

- [13] AirPrime HL7650 Product Technical Specification  
Reference number: 41110363
- [14] AirPrime HL7688 Product Technical Specification  
Reference number: 4119272
- [15] AirPrime HL7690 Product Technical Specification  
Reference number: 4118552
- [16] AirPrime HL7692 Product Technical Specification  
Reference number: 4119631
- [17] AirPrime HL8518, HL8528 and HL8529 Product Technical Specification  
Reference number: 4117047
- [18] AirPrime HL8548 and HL8548-G Product Technical Specification  
Reference number: 4114663
- [19] AirPrime WPx5 Product Technical Specification  
Reference number: 4116440
- [20] AirPrime WPx6 Product Technical Specification  
Reference number: 4119652
- [21] AirPrime RC76xx Product Technical Specification  
Reference number: 41113440





## 2. Snap-in Socket Characteristics

The Snap-in Socket is dedicated for use with any 22x23 mm HL, WP, or RC76 Series module from Sierra Wireless.

Two variants of the Snap-in socket frame exist; one to support the HL series (66 signals on one ring) and the other to support the WP series and RC76 series (157 signals on 2 rings). Likewise, two variants of the Snap-in cover exists to support the 2 different module thicknesses (2.5 and 4.4 mm thickness).

The Snap-in Socket footprint is compatible with the module footprint, so it is possible to design a unique PCB that allows for either the Snap-in socket or the module to be soldered on directly.

The AirPrime Snap-in Socket has been tested with the different bearers, 2G, 3G and 4G; and can be used to easily switch modules from the HL, WP, or RC76 series.

### 2.1. Storage Temperature Range

Storage conditions are the range of ambient temperature where the connector housing can be stored without load.

Storage temperature is -40°C to 85°C.

Relative humidity is 15% RH to 70% RH.

### 2.2. Operating Temperature Range

The range of ambient temperature for the connector housing which can be operated continuously at rated voltage and rated current is -40°C to 85°C, 70% RH max.

### 2.3. Standard Atmospheric Condition

Unless otherwise specified, specifications are given under the following atmospheric conditions:

Ambient temperature: 5°C to 35°C

Relative humidity: 45%RH to 85%RH

Air pressure: 86kPa to 106kPa

### 2.4. Electrical Characteristics

Tests are performed in mated condition with mating applicable modules.

Items	Conditions	Specifications
Rated voltage/rated current		AC/DC 50V, 0.5A
Contact resistance	Connect with applicable modules, then contact resistance shall be measured between each coupled terminal.	30mΩ or less
Insulation resistance	100V DC shall be applied for 1 minute, then measurement shall be made.	Between conductors. 100MΩ or more

Items	Conditions	Specifications
Withstand voltage	100V AC shall be applied for 1 minute, then measurement shall be made.	Between conductors without damages such as arcs or breakdowns, etc.

## 2.5. Mechanical Characteristics

Items	Conditions	Specifications
Appearance		No defects such as cracks, scratches or blemishes.
Terminal retention force	The retention force when the terminal is extracted from connector housing shall be measured.	0.7N or more

## 2.6. Part Numbering Information

Description	SKU Number	Compatible Module Series
Snap-in Frame for HL Series	6000595	HL
Snap-in Frame for WP Series	6000636	WP and RC76
Snap-in Cover for 2.5 mm thick modules	6000596	HL, WP76, and RC76
Snap-in Cover for 4.4 mm thick modules	6000637	WPx5
Snap-in Removal Tool	6000658	HL, WP, and RC76

## 3. Handling

### 3.1. Storage of the AirPrime Snap-in Socket

AirPrime Snap-in socket can be stored in their original packages, for up to 1 year.

**Tip:** For optimal results, the recommended storage temperature is  $+20^{\circ}\text{C} \pm 10$  degrees.

### 3.2. Component Package

The Snap-in Socket is a scalable QFP, 27.4x28.4 mm, pitch 0.8 mm.

	HL Series	WP Series
Height with the cover assembled	4.9 ± 0.2 mm for 2.5 mm thick modules 6.9 ± 0.2 mm for 4.4 mm thick modules	
Number of contacts	66 pins	157 pins
Weight with a 2.5 mm cover	4.7 g	

For additional information on HL, WP, or RC76 Series modules, refer to the corresponding Product Technical Specification listed in section 1.2 Reference Documents.

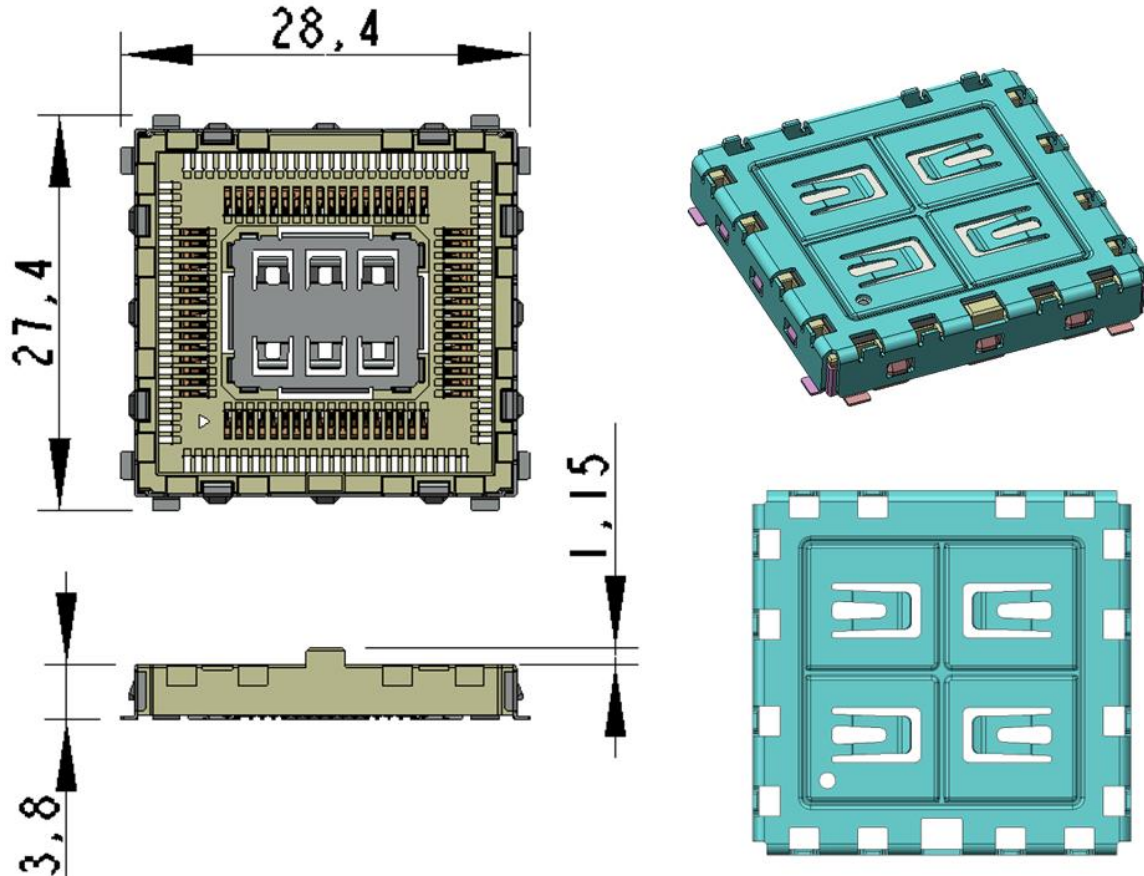

Figure 1. AirPrime Snap-in Socket

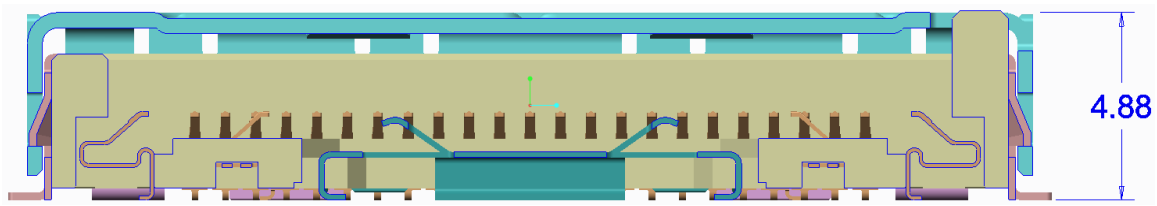

Figure 2. Sectional View of the 2.5 mm thick module Socket

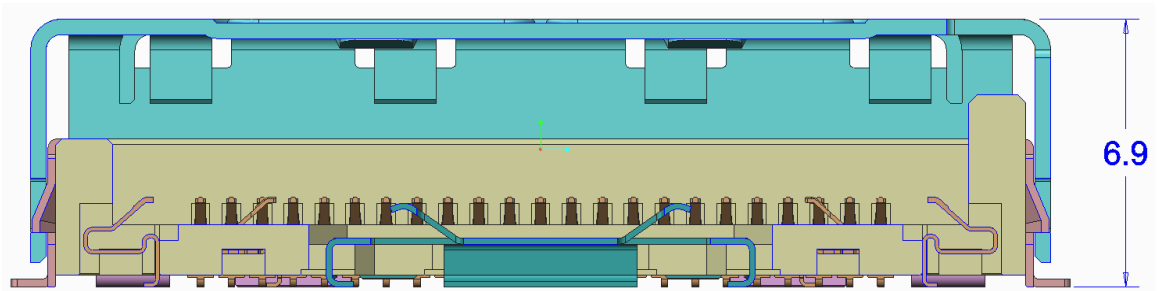

Figure 3. Sectional view of the 4.4 mm thick module Socket

### 3.3. Component Packing

The frame of the Snap-in Socket is delivered in tape and reel. There are 350 frames per tape and reel.

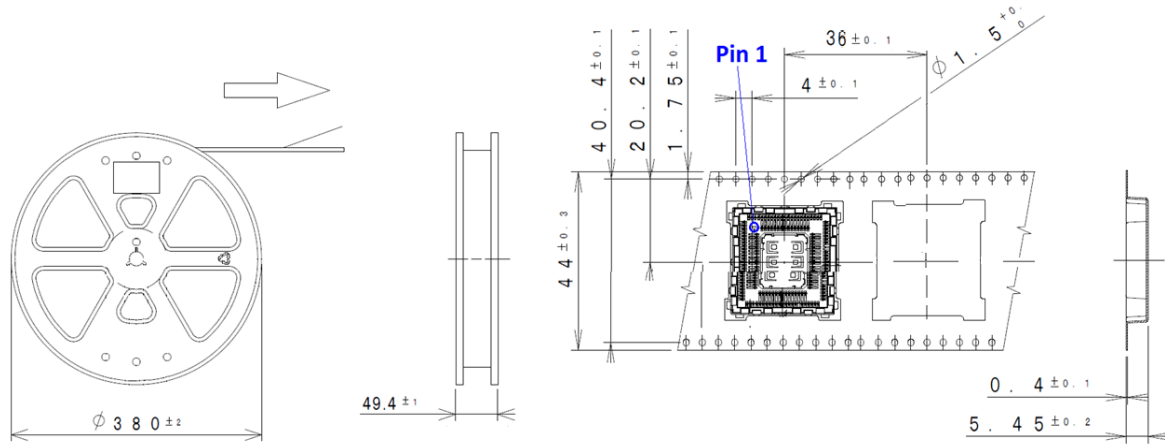
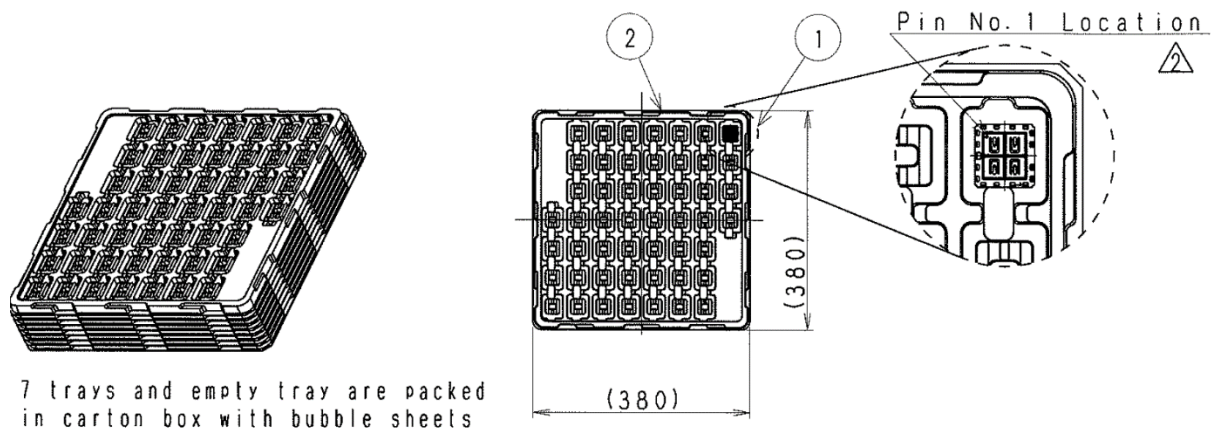

Figure 4. AirPrime Snap-in Socket Frame Delivered in Tape and Reel

The cover of the Snap-in Socket is delivered in tray. The tray size is 380x380mm. There are 350 covers per tray.



7 trays and empty tray are packed in carton box with bubble sheets

Figure 5. AirPrime Snap-in Socket Cover Delivered in Tray



## 4. SMT Assembly Process

This section presents information and recommendations for the industrial assembly of the AirPrime Snap-in Socket on the application.

---

**Note:** *The AirPrime Snap-in socket frame should be assembled by reflow process.*

---

### 4.1. Lead-Free Process

In compliance with directive 2011/65/CE, Sierra Wireless products do not contain the following hazardous substances:

- mercury (Hg),
- lead (Pb),
- cadmium (Cd),
- hexavalent chromium (Cr+6),
- polybrominated diphenyl ether (PBDE),
- polybrominated biphenyl (PBB).

The AirPrime Snap-in Sockets are manufactured with RoHS compliant components and processes.

### 4.2. PCB Design Requirements

#### 4.2.1. PCB Surface Finish

The PCB surface finish recommended is Electroless Nickel, immersion Gold. Organic Solderability Preservative (OSP) may also be used.

---

**Caution:** *Hot Air Solder Leveled finish (HASL) is not recommended because the process does not give consistent solder volumes on each pad because of poor pad flatness.*

---

#### 4.2.2. Footprint

In order to produce high assembly yields and a reliable solder joint, footprint design should match either Figure 7 or Figure 9 below. These footprints are compatible for either soldering the module on its own or for soldering a Snap-in Socket.

Mechanical drawings of the module's footprint are available in the Product Technical Specification of each product as listed in section 1.2 Reference Documents.

The following should also be noted when designing the footprint:

- The 64 inner pads and the 8 corner pads are ground pads. Not all of these are present on the Snap-in Socket. Moreover, JTAG pins are also not present on the Snap-in Socket.
- Sierra Wireless suggests that customers place a copper pad under the Polarity mark to avoid any risk of short circuits between this pin and the customer layout; however, there is no need to solder it. This mark also eases visual confirmation of the correct orientation of the module.
- Manufacturing tolerance for copper pads is 30 µm.



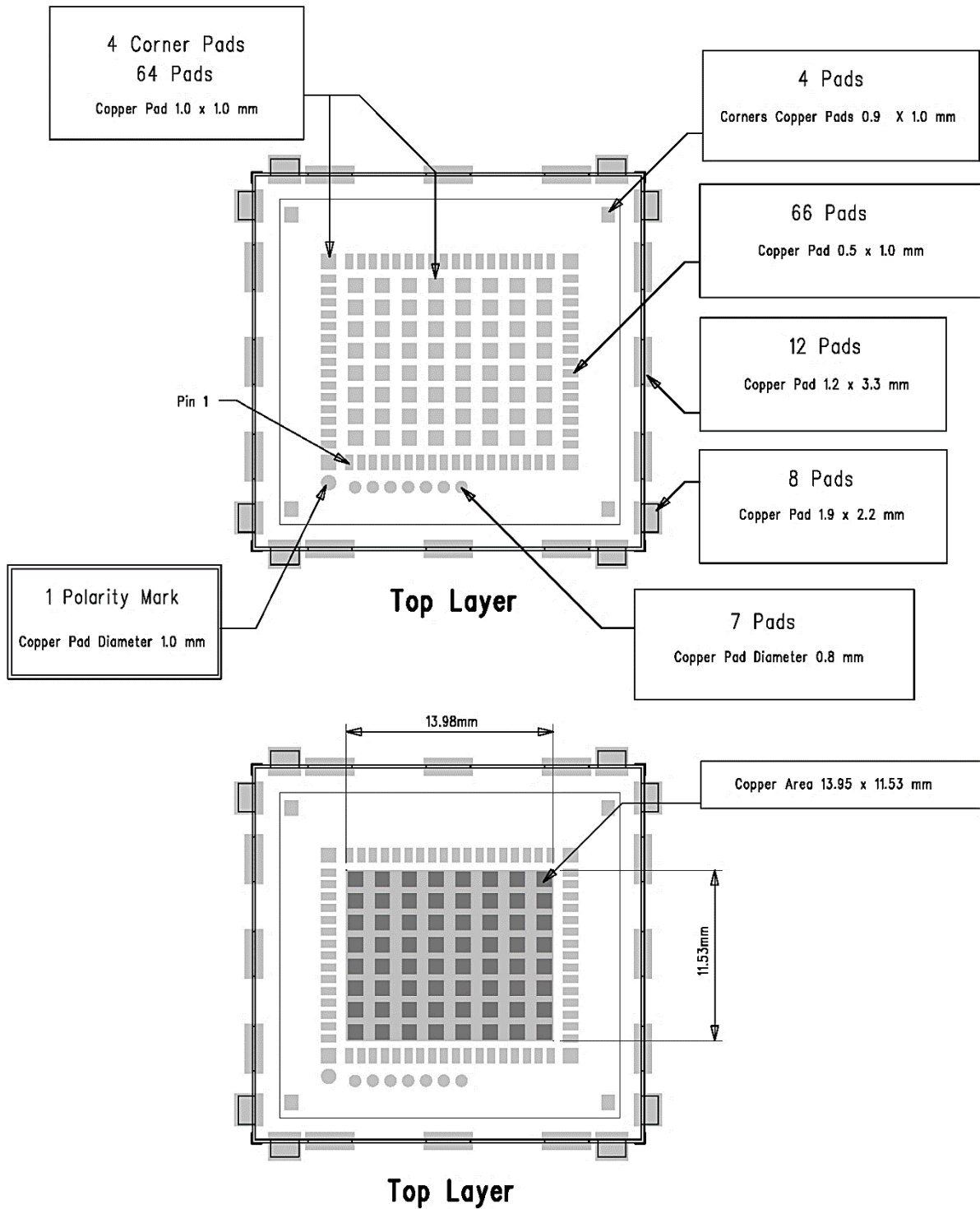

Figure 7. Recommended HL Series Snap-in Socket Footprint – Copper Layout





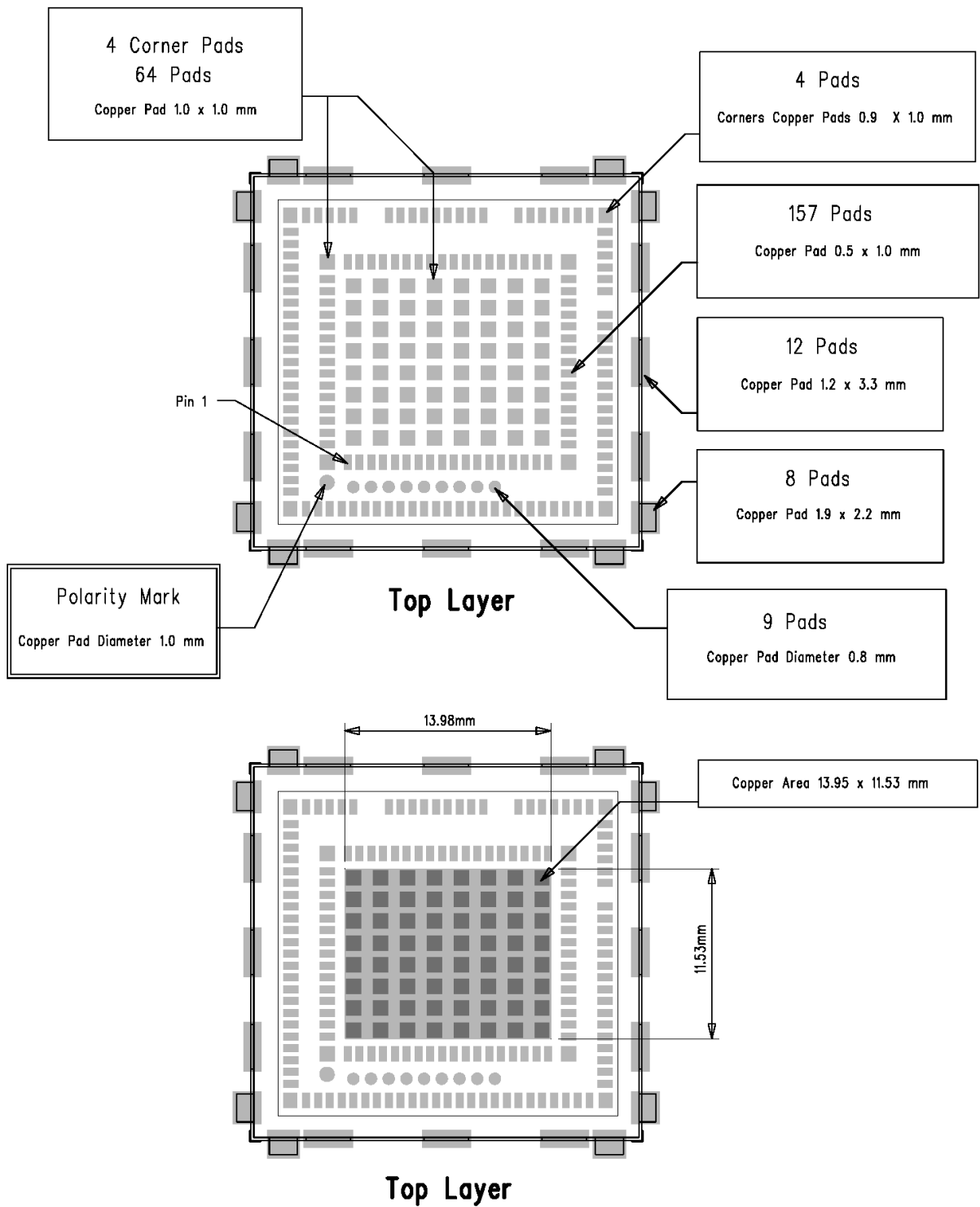

Figure 9. Recommended WP and RC76 Series Snap-in Socket Footprint – Copper Layout

### 4.2.3. Layout Recommendations

Sierra Wireless' layout recommendations include:

- A ground area under the AirPrime Snap-in Socket. This ground area should be a whole area of copper with proper ground vias to provide a good grounding system between the application and the embedded module and improved thermal dissipation. It should be covered by solder resist on the non-soldered area.

The ground vias may be micro-vias, filled or unfilled. Through-holes can be used between each of the 64 ground pads (under the solder resist).

- The antenna pad and its track should be adapted according to RF constraints, based on customer layout. Refer to each corresponding Product Technical Specification for more details.
- There shouldn't be any SIGNAL trace or hole/micro-via under the AirPrime module.
- Leave a component-free area of 0.5 mm around the Snap-in Socket body (27.4x28.4 mm) for accessing the surrounding components.

### 4.3. Solder Mask

The pads on the printed circuit board are either Solder Mask Defined (SMD) or Non-Solder Mask Defined (NSMD).

Since the copper etching process has tighter control than solder masking process, NSMD pads are preferred over SMD pads.

Moreover, NSMD pads with solder mask opening larger than the metal pad size also improve the reliability of solder joints, as this limits the stress concentration at the solder-to-mask corner interface.

For external pads, the solder mask opening should be 100  $\mu\text{m}$  to 150  $\mu\text{m}$  larger than the pad, resulting in 50  $\mu\text{m}$  to 75  $\mu\text{m}$  clearance between the copper pad and solder mask. This allows for solder mask registration tolerances, depending on the PCB fabricator's capabilities.

For ground pads, SMD should be used if a copper ground area is under the AirPrime module.

Recommended solder mask thickness on the top copper is 10 to 30  $\mu\text{m}$ .

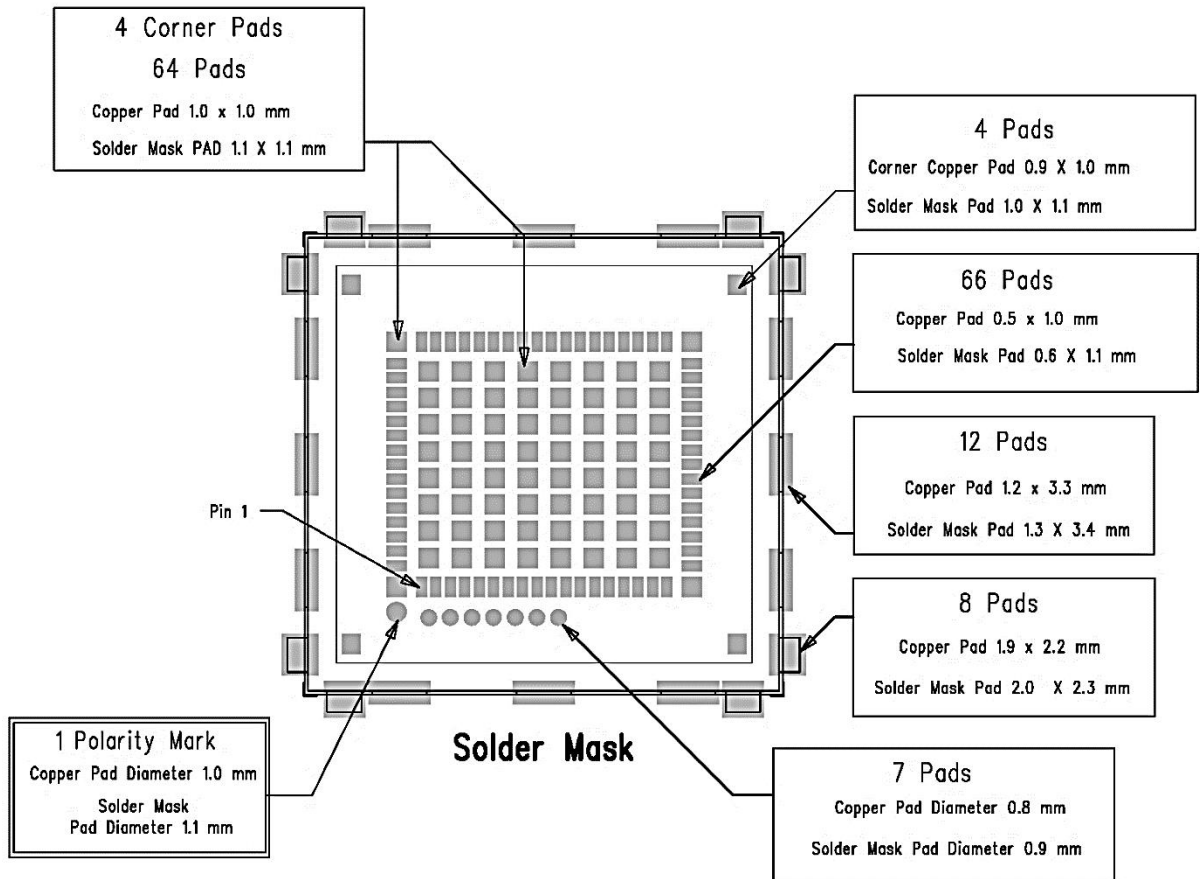

Figure 10. Recommended HL Series Snap-in Socket Footprint – Solder Mask Layout

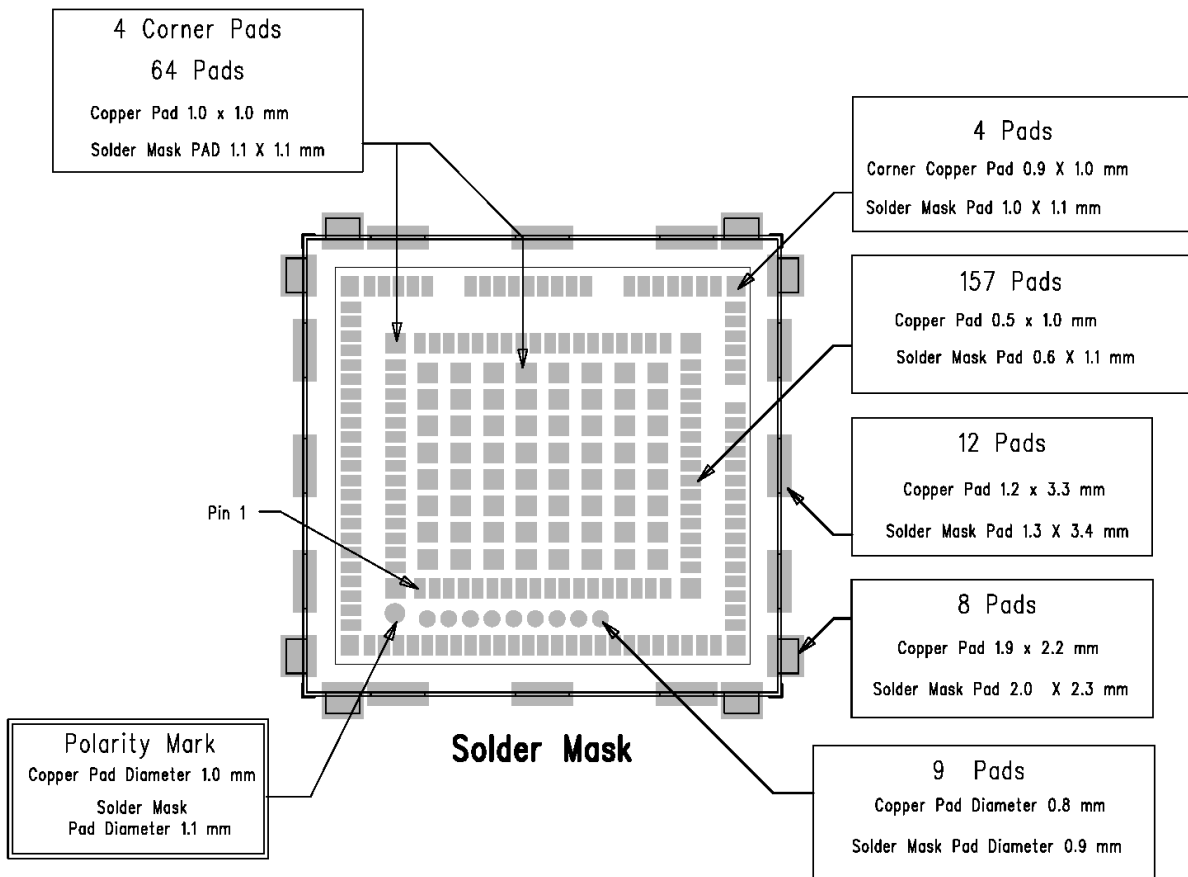

Figure 11. Recommended WP and RC76 Series Snap-in Socket Footprint – Solder Mask Layout



## 5. Board Mounting Guidelines

### 5.1. Stencil Design

The recommended stencil thickness is 125  $\mu\text{m}$ .

The proposed stencil design is presented in Figure 12 and Figure 13 below. It is recommended to have a different stencil when mounting the Snap-in Socket and when soldering the module on its own.

It is highly recommended to monitor the solder paste height, registration and proper placement during the squeegee printing.

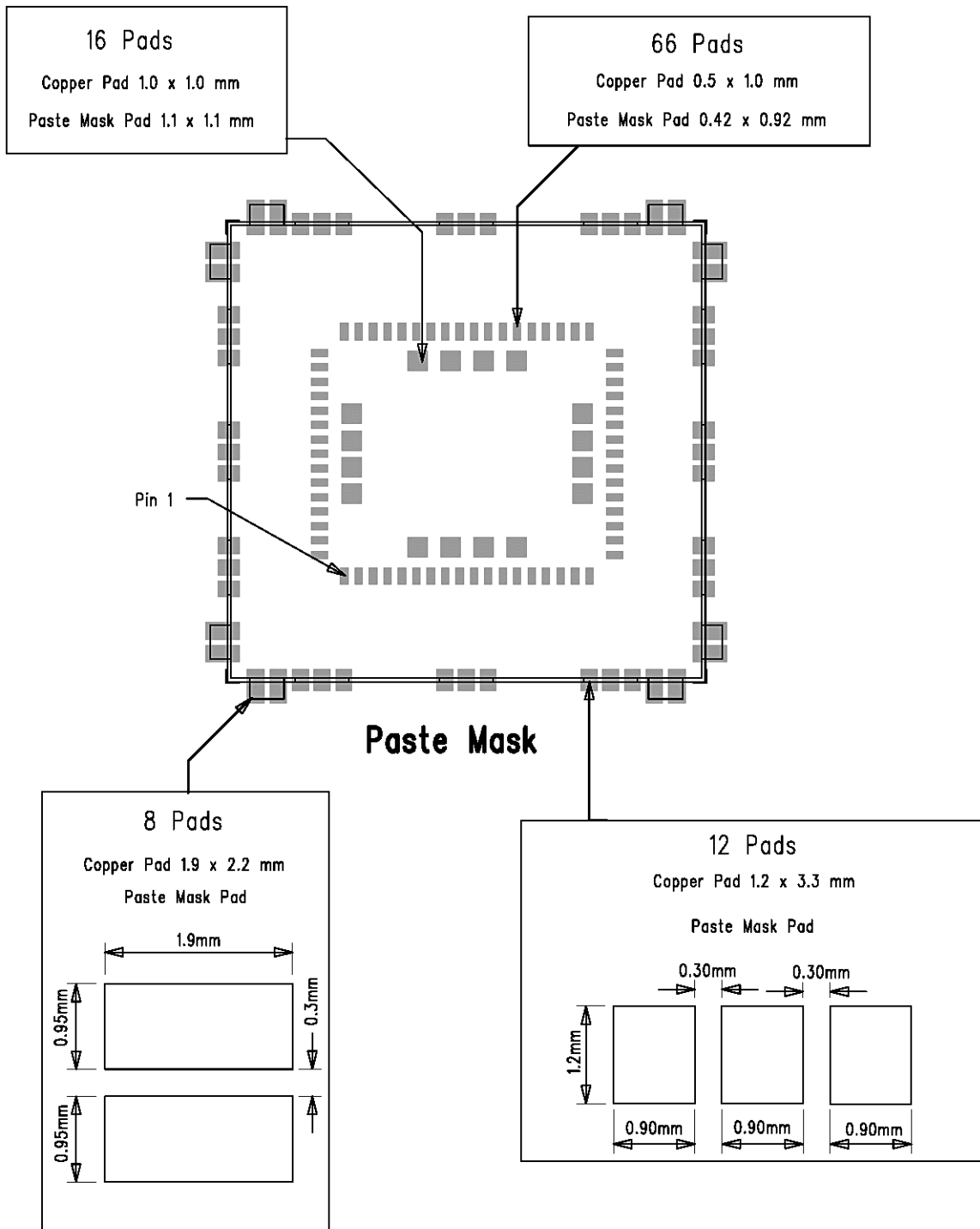

Figure 12. Recommended HL Series Snap-in Socket Footprint – Paste Mask Layout

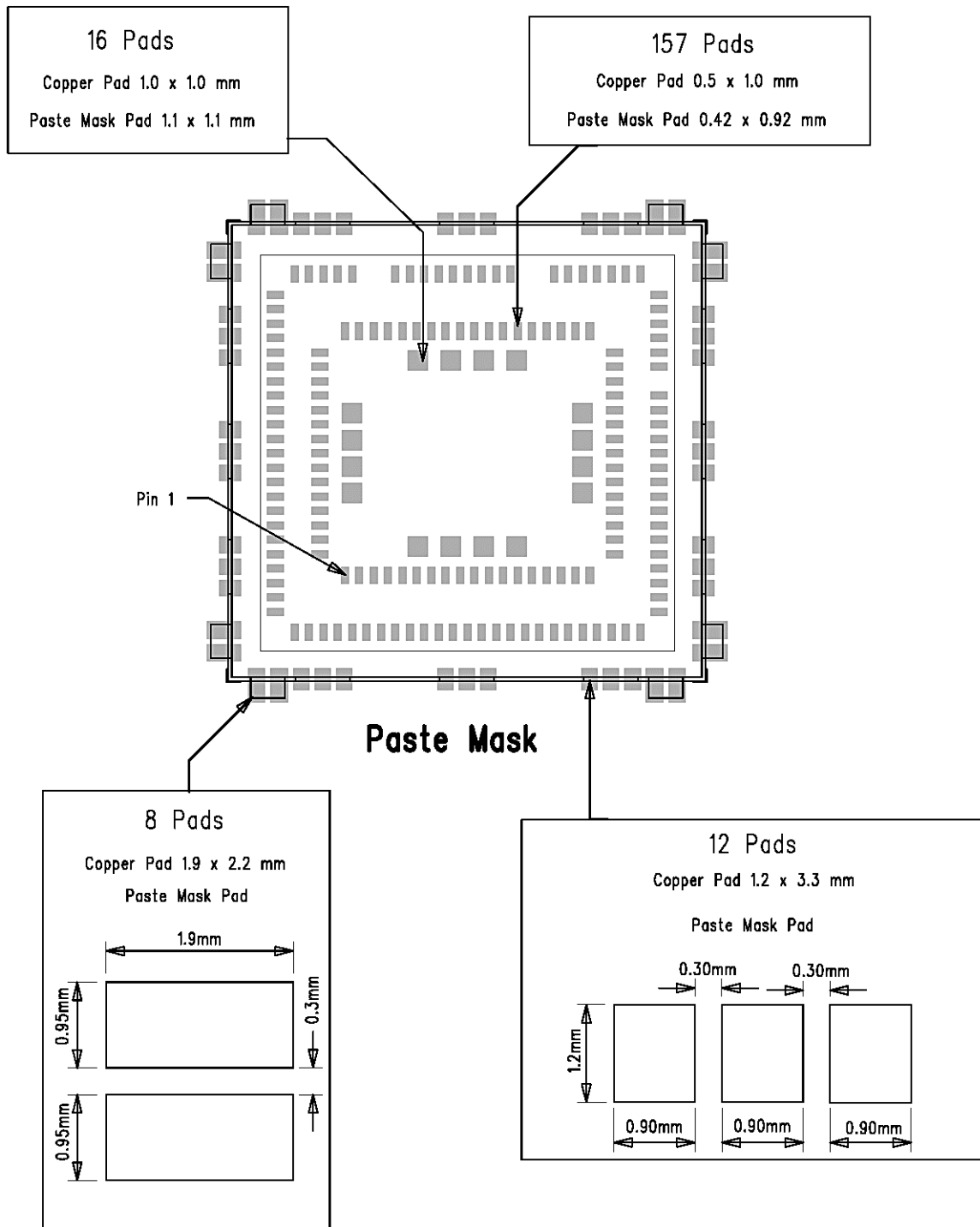

Figure 13. Recommended WP and RC76 Series Snap-in Socket Footprint – Paste Mask Layout



## 5.2. SMT Process Parameters

The Pick & Place area to be used for the SMT process is 3.7 mm in diameter, centered on the heat-sink.

Speed: Slowest speed for the machine.

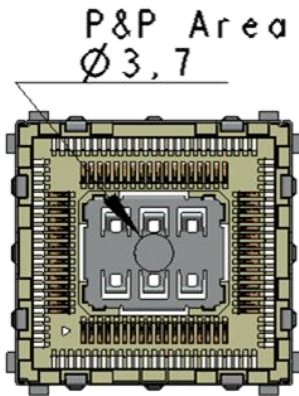

Figure 14. Pick & Place Area

## 5.3. Solder Reflow Profile

Lead-free SMT reflow profiles should be used to surface mount the AirPrime Snap-in socket.

The reflow profile depends on PCB density and type of solder paste being used. The paste manufacturer’s recommendation should also be considered to determine the proper reflow profile.

<b>Peak Temperature</b>	245°C max
-------------------------	-----------

Due to its weigh, it is preferable to solder the Snap-in Socket on the last side.

The figure below is a reflow profile example.

Example of reflow profile:

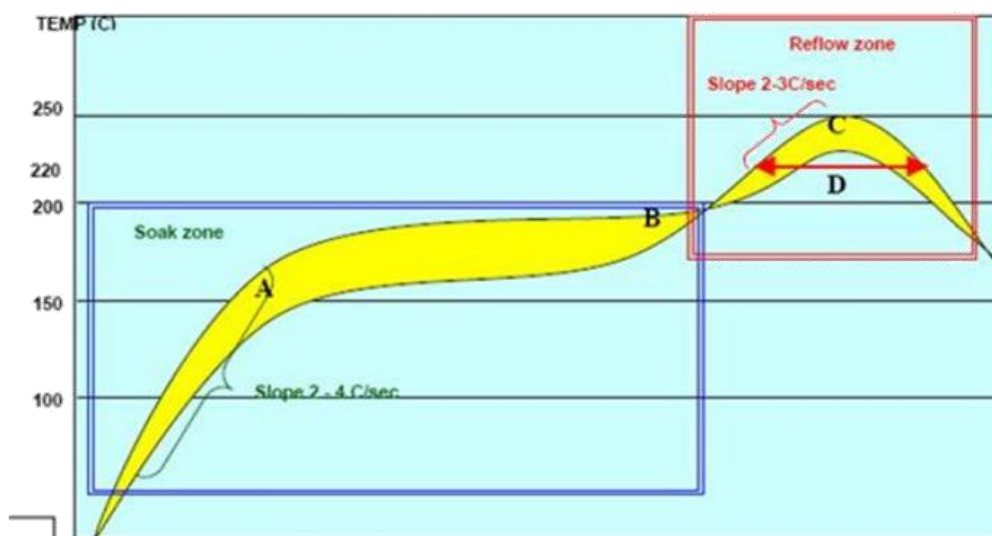

Figure 15. Recommended Reflow Profile

Additional recommendations are presented in the table below for consideration.

<b>Factor</b>	<b>Recommendation</b>
Max slope	2 to 4 °C / sec
Soak time (between A and B: 150 and 190 °C)	60 to 120 sec
Reflow time (D: over 220°C)	40 to 60 sec
Max temperature (C)	235 – 245 °C
Cooling down slope	1 to 3 °C / sec

## 6. Insertion and Removal Guidelines

### 6.1. Visual Inspection

Prior to inserting the module, the operator should inspect the module and ensure that pins are not deformed.

One typical failure is bent contacts; to avoid this, refer to section 6.4 for information regarding proper handling of the Snap-in Socket.

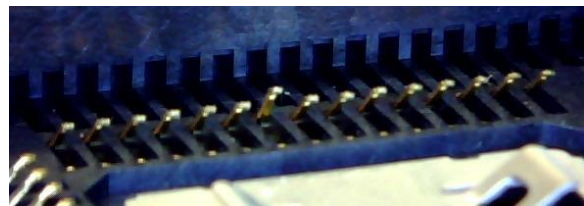
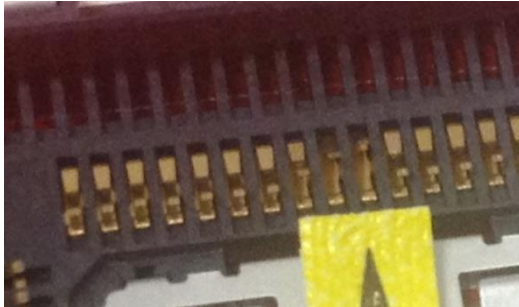

Figure 16. Example of Bent Contacts

---

*Note:* Failure tends to happen on internal rows.

---

### 6.2. Insertion Guideline

1. Check the alignment of the Polarity mark on both the module and the Snap-in socket.

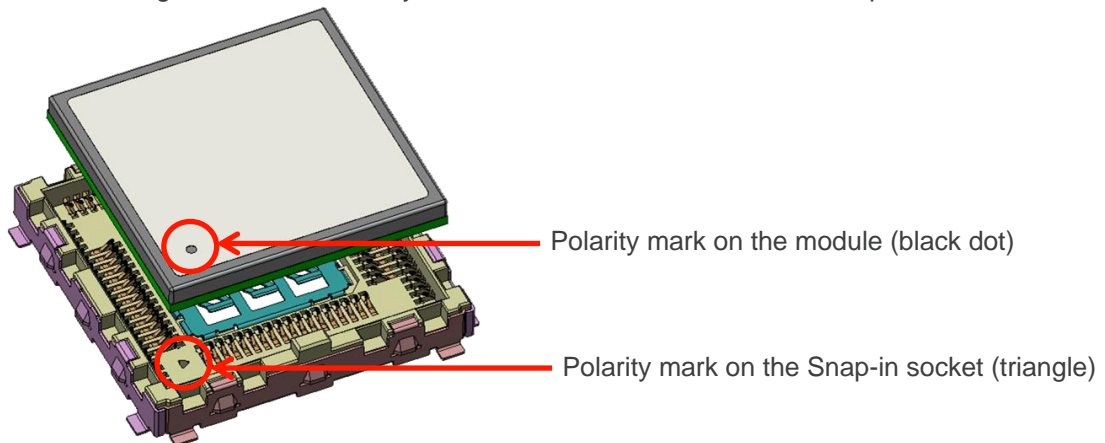

- Put the module down in the socket. Use vertical motion to insert the module.

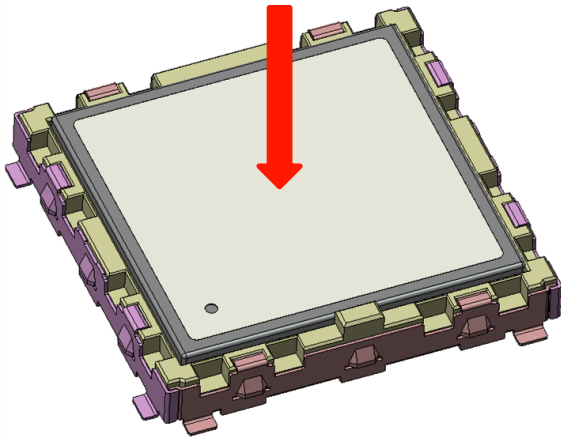

- Check the orientation of the cover based on the location of the Polarity mark.

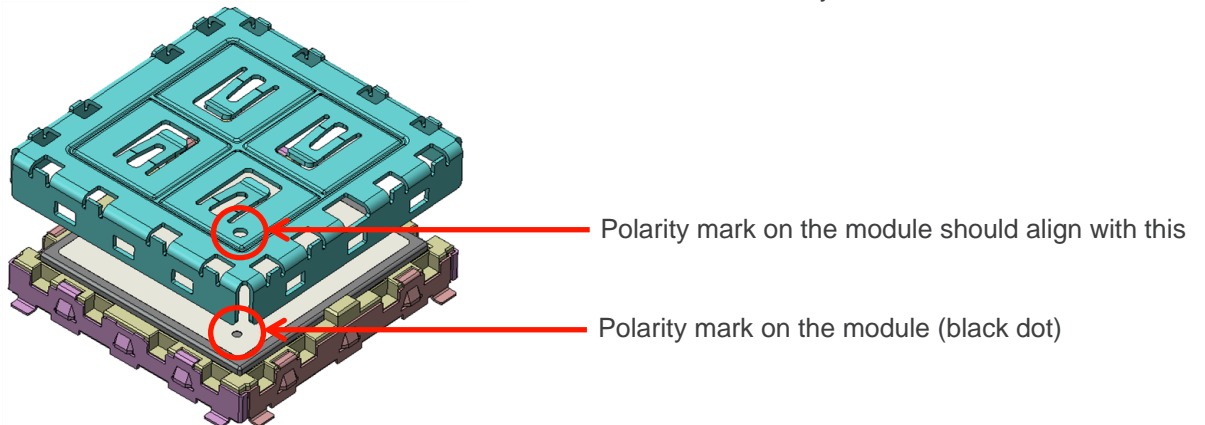

- Smoothly press the cover on to the Snap-in socket. The cover should be properly aligned with the Polarity mark on the module.

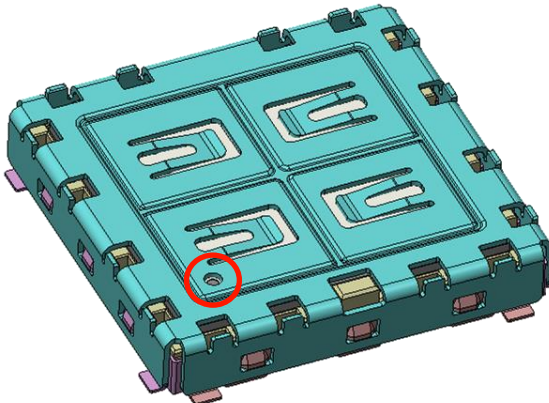

5. Check that the cover holes are locked on the socket bumps on all sides.

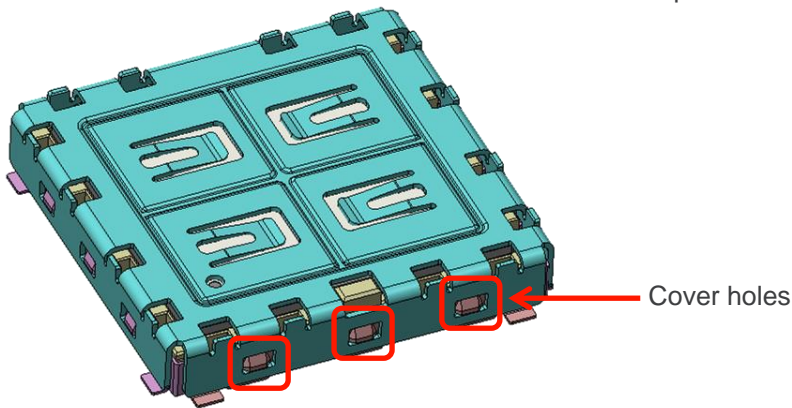

### 6.3. Removal Guidelines

Use the specific Snap-in removal tool to dismount the cover.

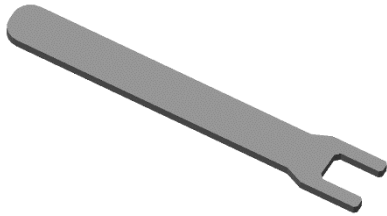

Figure 17. AirPrime Snap-in Socket Removal Tool

To dismount the cover from the Snap-in socket, insert the Snap-in removal tool in the socket cavity, and then smoothly push the tool to pull up the cover and disengage the cover holes from the socket bumps.

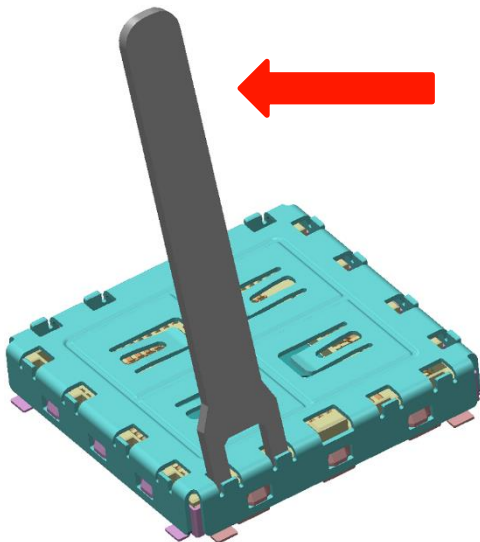

Figure 18. Snap-in Socket Removal Tool

Repeat the same operation on each side of the cover.

Do not apply excessive force that may damage the cover or the socket.

It is recommended to only use the cover for a maximum of 3 times and then replaced.

## 6.4. AirPrime Snap-in Socket Damage Prevention

Contact damage can be caused by incorrect operation. Refer to the following sub-sections for more information on what causes contact damage and how to prevent it.

### 6.4.1. Socket

- Touching or applying a force directly on the socket contacts would result in contact damage.
- Inserting/removing the module incorrectly would result in contact damage.

---

*Note:* Only use vertical motion to insert and/or remove the module. Tilting is not allowed

---

- Do not apply force onto the heat sink legs, to avoid unexpected deformation.

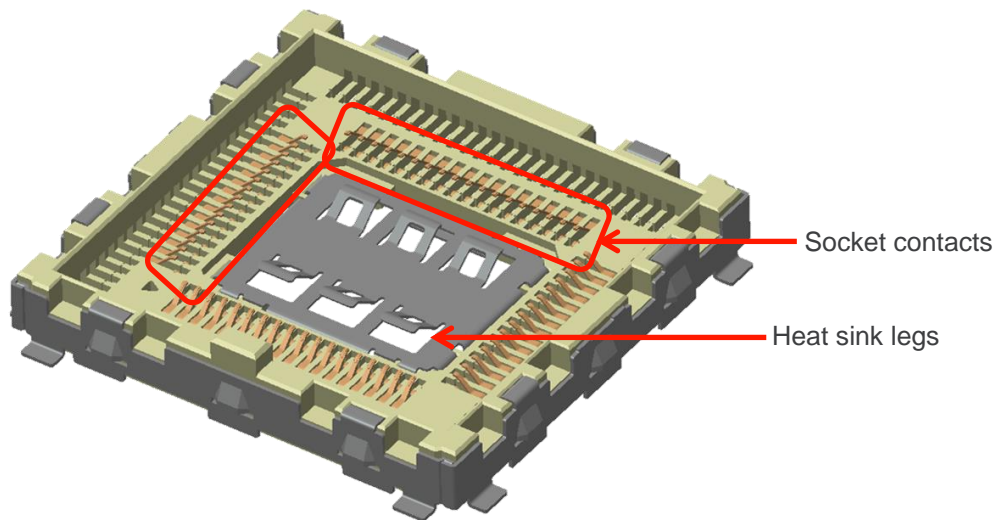

Figure 19. Socket Contacts and Heat Sink Legs Location

### 6.4.2. Cover

- Check that the cover is in the right position (based on the Polarity mark) before locking the cover on the socket. For more information, refer to section 6.2 Insertion Guideline
- Use the removal tool to smoothly remove the cover without causing any damage.