

# SmartSlice I/O

## Plug-and-Play I/O

Remote I/O with digital and analogue I/O units, relay outputs and configurable temperature inputs. All SmartSlice units feature screwless 'push-in' I/O wiring, detachable I/O connector, and hot-swap capability. The EtherCAT 'coupler' automatically scans the connected I/O units at startup. The NJ-Series controller will verify the detected configuration against the registered configuration at startup.

- Up to 64 I/O units per station
- Screwless wiring
- Automatic I/O assignment
- Easy configuration backup
- Hot-swap with auto-restore
- Optional address setting



## System Configuration

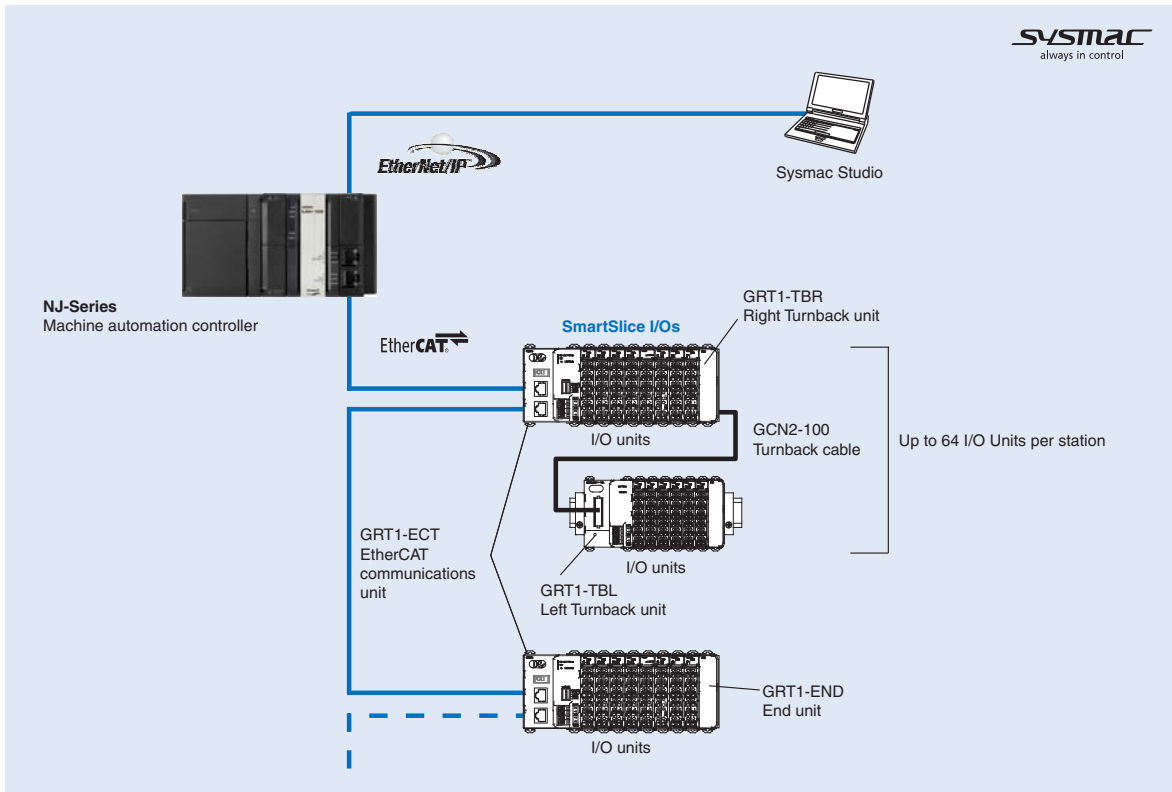

## Specifications/Wiring

### General Specifications

Common SmartSlice Specifications	
Unit power supply voltage	24 VDC (20.4 to 26.4 VDC)
I/O power supply voltage	24 VDC (20.4 to 26.4 VDC)
I/O connection	Screwless push-in technology
Noise immunity	Conforms to IEC61000-4-4, 2.0 kV (power supply line)
Vibration resistance	10 to 60 Hz: 0.7 mm double amplitude 60 to 150 Hz: 50 m/s <sup>2</sup>
Shock resistance	150 m/s <sup>2</sup> , 3 times in each direction
Dielectric strength	500 VAC (between isolated circuits)
Insulation resistance	20 MΩ min. (between isolated circuits)
Ambient operating temperature	-10 to 55°C (with no icing or condensation)
Ambient operating humidity	25% to 85%
Operating environment	No corrosive gases
Ambient storage temperature	-25 to 65°C (with no icing or condensation)
Mounting	35 mm DIN rail

### Communication Units

Model name	GRT1-ECT
Network Specification	EtherCAT for Sysmac (NJ)
Network connector	2 x RJ45
Network interface power supply	External 24 VDC (+10% - 15%)
Number of I/O points	1,024 inputs and outputs max. (128 bytes total)
Number of connectable Units	64 SmartSlice I/O Units max.
I/O power supply	24 VDC, 4 A max.
Status flags	1 word for Communications Unit status flag
Parameter backup and restore	Up to 2 KB of data per I/O Unit

### Digital Input Units

Model name	GRT1-ID4	GRT1-ID4-1	GRT1-ID8	GRT1-ID8-1
Signal type	DC input (for sinking outputs, NPN type)	DC input (for sourcing outputs, PNP type)	DC input (for sinking outputs, NPN type)	DC input (for sourcing outputs, PNP type)
Number of input points	4 inputs		8 inputs	
Power terminals	4 x V (24 V) + 4 x G (0 V)		4 x G (0 V)	4 x V (24 V)
ON voltage	15 VDC min.			
ON current	6 mA max./point (at 24 VDC)		4 mA max./point (at 24 VDC)	
OFF voltage	5 VDC max.			
OFF current	1 mA max.			
ON delay / OFF delay	1.5 ms max.			

Model name	GRT1-IA4-1	GRT1-IA4-2
Signal type	AC input, 110 V	AC input, 230 V
Number of input points	4 inputs	
Power terminals	None	
Input voltage	100 to 120 VAC -15% to +10%, 50/60 Hz	200 to 240 VAC -15% to +10%, 50/60 Hz
ON voltage	70 VAC min.	120 VAC min.
ON current	4 mA min.	
OFF voltage	20 VAC max.	
OFF current	2 mA max.	
ON delay / OFF delay	10 ms max./55 ms max.	10 ms max./40 ms max.

## GRT1-ID4 (NPN)

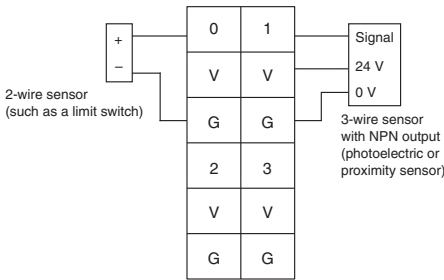

## GRT1-ID4 -1 (PNP)

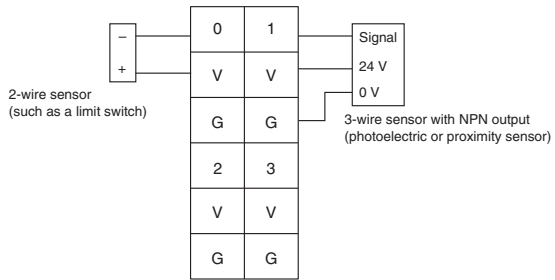

## GRT1-IA4-1/GRT1-IA4-2

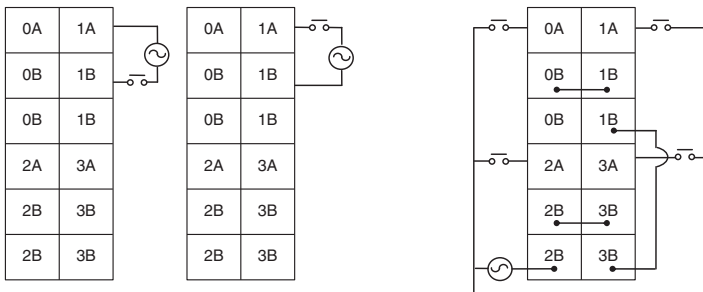

**Note:** No common signal for inputs.

**Note:** Common signal for four inputs.

## GRT1-ID8 (NPN)

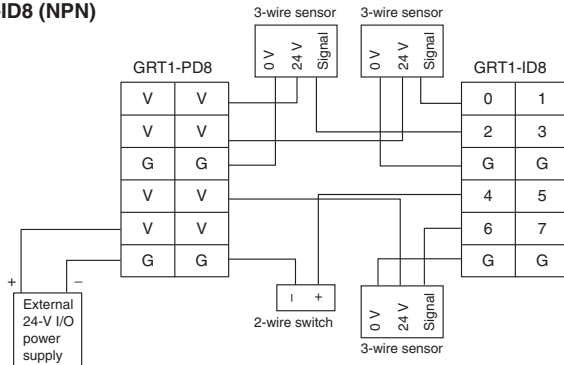

## GRT1-ID8-1 (PNP)

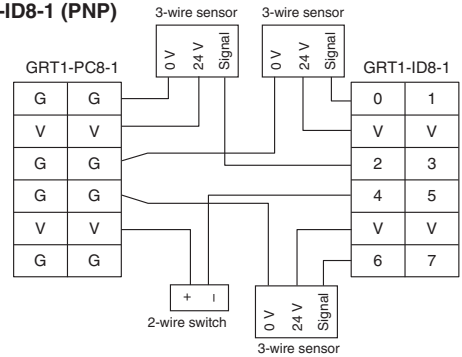

## Digital Output Units

Model name	GRT1-OD4	GRT1-OD4-1	GRT1-OD4G-1	GRT1-OD4G-3
Signal type	Transistor output (NPN type, sinking)	Transistor output (PNP type, sourcing)	Transistor output (PNP type, sourcing), with short-circuit protection	
Number of output points	4 outputs			
Power terminals	4 x V (24 V)	4 x G (0 V)	4 x V (24 V) + 4 x G (0 V)	
Rated voltage	24 VDC (20.4 to 26.4 VDC)			24 V I/O power supply via the front terminal of the unit.
Rated output current	500 mA max./point			from 4 x 2.0 A at 30 °C to 4 x 1.0 A at 55 °C
Residual voltage	1.2 VDC max. (at 500 mA)			1.2 VDC max. (at 2 A)
Leakage current	0.1 mA max.			
ON delay / Off delay	0.5 / 1.5 ms max.			

Model name	GRT1-OD8	GRT1-OD8-1	GRT1-OD8G-1	GRT1-ROS2
Signal type	Transistor output (NPN type, sinking)	Transistor output (PNP type, sourcing)	Transistor output (PNP type, sourcing), with short-circuit protection	Relay output (normally open)
Number of output points	8 outputs			2 outputs (with 2 terminals per connection)
Power terminals	4 x V (24 V)	4 x G (0 V)		n.a.
Rated voltage	24 VDC (20.4 to 26.4 VDC)		250 VAC / 24 VDC	
Rated output current	500 mA max./point			2 A (min. 1 mA @ 5 VDC)
Residual voltage	1.2 VDC max. (at 500 mA)			-
Leakage current	0.1 mA max.			-
ON delay / Off delay	0.5 / 1.5 ms max.			15 ms max.
Mechanical life expectancy	-			20,000,000 times min.
Electrical life expectancy	-			100,000 times min.

### GRT1-OD4

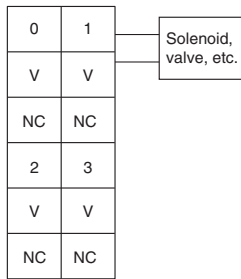

### GRT1-OD4-1

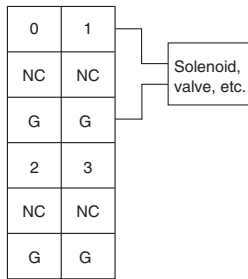

### GRT1-OD4G-1 (PNP)

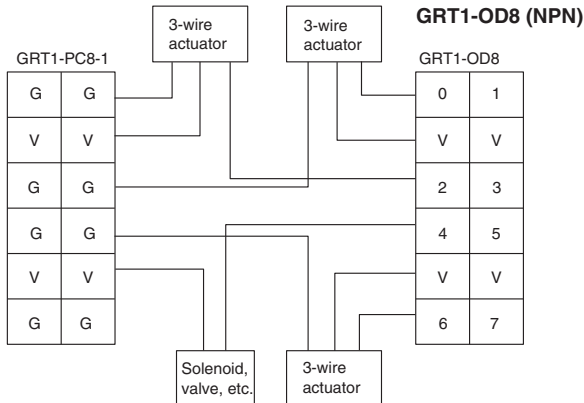
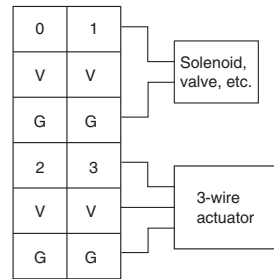

### GRT1-OD4G-3 (PNP)

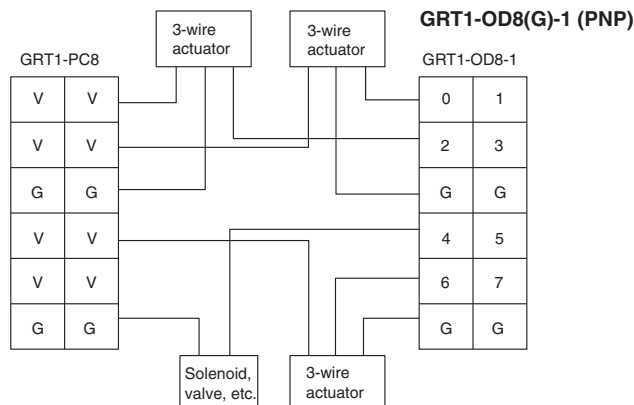
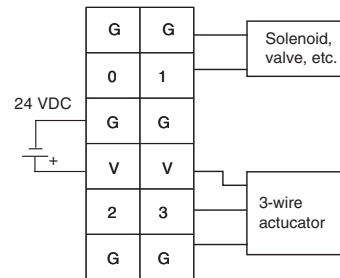

### GRT1-ROS2

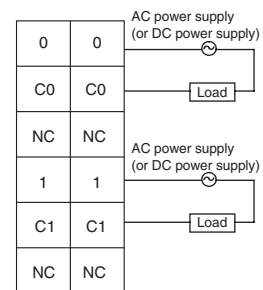

Analog I/O Units

Model name	GRT1-AD2	GRT1-DA2V	GRT1-DA2C
Signal type	Analog Input: 0-20mA, 4-20mA, ±10V, 0-10V, 0-5V, 1-5V	Analog Output: ±10V, 0-10V, 0-5V, 1-5V	Analog Output: 0-20mA, 4-20mA,
Number of points	2 inputs	2 outputs	
Resolution	1/6000 full scale		
Conversion time	2ms / 2points		

Model name	GRT1-TS2P	GRT1-TS2PK	GRT1-TS2T
Signal type	Temperature input, Pt100, (2-wire, 3-wire)	Temperature input, Pt1000, (2-wire, 3-wire)	Thermocouple, R, S, K, J, T, E, B, N, L, U, W, or PL2
Number of points	2 inputs		
Indication range	-200 to +200 °C / -200 to +850 °C		Depends on thermocouple type
Accuracy	±0.3% of PV or ±0.8 °C* (whichever is larger) ±1 digit max. * (or ±0.5 °C for -200 °C to +200 °C input range)		±2°C ±1 digit max. Mounting restrictions apply. See Operation Manual W455
Resolution	0.1 °C, 16-bit signed integer, or 0.01 °C, 32-bit signed double integer		
Conversion time	250 ms / 2 points		

GRT1-AD2

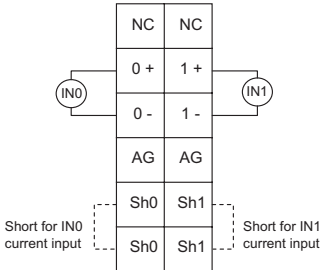

GRT1-DA2V

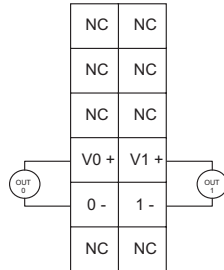

GRT1-DA2C

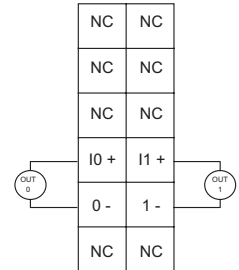

GRT1-TS2P/PK (2-wire)

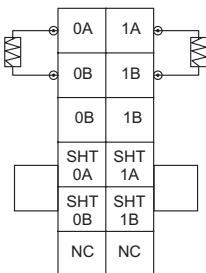

GRT1-TS2P/PK (3-wire)

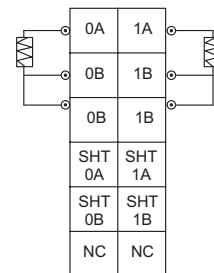

GRT1-TS2T

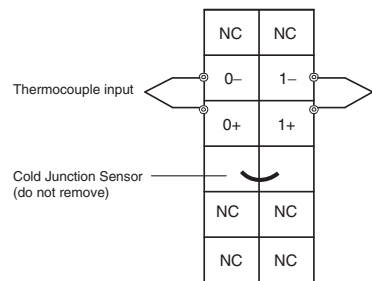

System Configuration  
Machine Automation Controller  
Automation Software  
System Configuration  
AC Sensors / Servo Drives  
Specifications  
Multi-function Compact Inverter  
Dimensions  
Vision Sensor  
Remote I/O Terminals  
Ordering Information

# SmartSlice I/O

## Power Feed and Distribution Units

**GRT1-PD2**

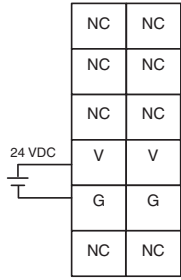

**GRT1-PD2G**

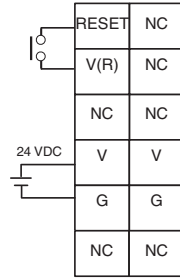

**GRT1-PD8**

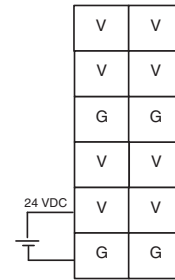

**GRT1-PD8-1**

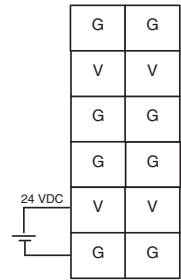

**GRT1-PC8**

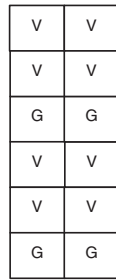

**GRT1-PC8-1**



# Dimensions

## I/O-units

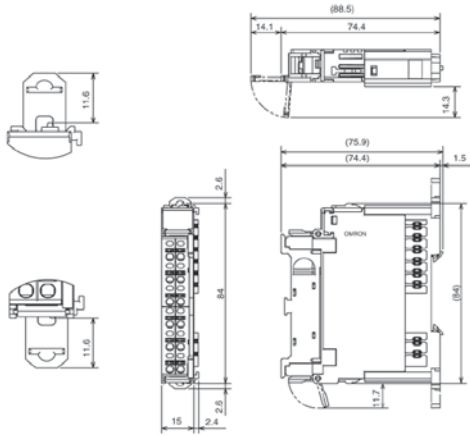

## Communication Units

### GRT1-ECT

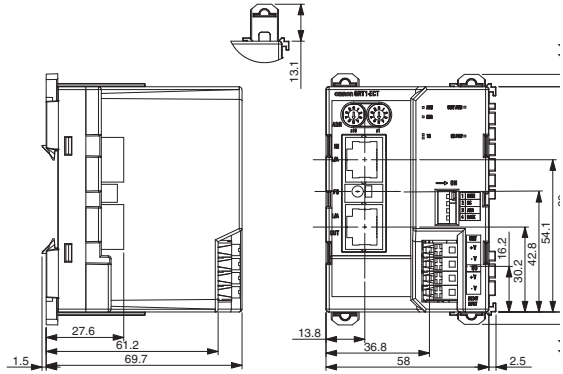

## End units

- GRT1-END
- GRT1-END-M
- GRT1-TBR

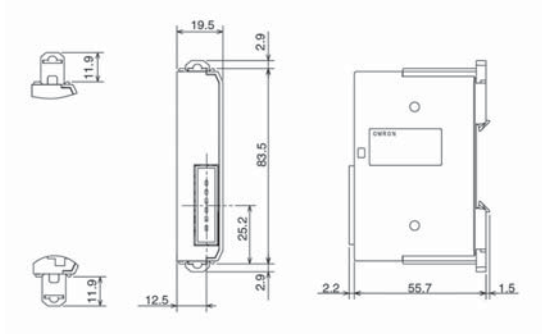

- System Configuration
- Machine Automation Controller
- Automation Software
- System Configuration
- AC Servomotors/ Servo Drives
- Specifications
- Multi-function Compact Inverter
- Wiring
- Dimensions
- Vision Sensor
- Remote I/O Terminals
- Ordering Information