

# ON Semiconductor

## Is Now

# onsemi™

To learn more about onsemi™, please visit our website at  
[www.onsemi.com](http://www.onsemi.com)

---

**onsemi** and **onsemi** and other names, marks, and brands are registered and/or common law trademarks of Semiconductor Components Industries, LLC dba "**onsemi**" or its affiliates and/or subsidiaries in the United States and/or other countries. **onsemi** owns the rights to a number of patents, trademarks, copyrights, trade secrets, and other intellectual property. A listing of **onsemi** product/patent coverage may be accessed at [www.onsemi.com/site/pdf/Patent-Marking.pdf](http://www.onsemi.com/site/pdf/Patent-Marking.pdf). **onsemi** reserves the right to make changes at any time to any products or information herein, without notice. The information herein is provided "as-is" and **onsemi** makes no warranty, representation or guarantee regarding the accuracy of the information, product features, availability, functionality, or suitability of its products for any particular purpose, nor does **onsemi** assume any liability arising out of the application or use of any product or circuit, and specifically disclaims any and all liability, including without limitation special, consequential or incidental damages. Buyer is responsible for its products and applications using **onsemi** products, including compliance with all laws, regulations and safety requirements or standards, regardless of any support or applications information provided by **onsemi**. "Typical" parameters which may be provided in **onsemi** data sheets and/or specifications can and do vary in different applications and actual performance may vary over time. All operating parameters, including "Typicals" must be validated for each customer application by customer's technical experts. **onsemi** does not convey any license under any of its intellectual property rights nor the rights of others. **onsemi** products are not designed, intended, or authorized for use as a critical component in life support systems or any FDA Class 3 medical devices or medical devices with a same or similar classification in a foreign jurisdiction or any devices intended for implantation in the human body. Should Buyer purchase or use **onsemi** products for any such unintended or unauthorized application, Buyer shall indemnify and hold **onsemi** and its officers, employees, subsidiaries, affiliates, and distributors harmless against all claims, costs, damages, and expenses, and reasonable attorney fees arising out of, directly or indirectly, any claim of personal injury or death associated with such unintended or unauthorized use, even if such claim alleges that **onsemi** was negligent regarding the design or manufacture of the part. **onsemi** is an Equal Opportunity/Affirmative Action Employer. This literature is subject to all applicable copyright laws and is not for resale in any manner. Other names and brands may be claimed as the property of others.

# ADT7482

## Dual Channel Temperature Sensor and Overtemperature Alarm

The ADT7482 is a three-channel digital thermometer and under/overtemperature alarm for PCs and thermal management systems. It can measure the temperature in two remote locations, such as in the remote thermal diode in a CPU or GPU, or using a discrete diode connected transistor. This device also measures its own ambient temperature.

One feature of the ADT7482 is series resistance cancellation where up to 1.5 k $\Omega$  (typical) of resistance in series with each of the temperature monitoring diodes can be automatically cancelled from the temperature result, allowing noise filtering. The temperature of the remote thermal diodes and ambient temperature can be measured accurate to  $\pm 1^{\circ}\text{C}$ . The temperature measurement range, which defaults to  $0^{\circ}\text{C}$  to  $127^{\circ}\text{C}$ , can be switched to a wider measurement range of from  $-55^{\circ}\text{C}$  to  $+150^{\circ}\text{C}$ .

The ADT7482 communicates over a 2-wire serial interface compatible with System Management Bus (SMBus) standards. The default address of the ADT7482 is 0x4C. An ALERT output signals when the on-chip or remote temperature is outside the programmed limits. The THERM output is a comparator output that allows on/off control of a cooling fan. The ALERT output can be reconfigured as a second THERM output if required.

### Features

- 1 Local and 2 Remote Temperature Sensors
- $0.25^{\circ}\text{C}$  Resolution/ $1^{\circ}\text{C}$  Accuracy on Remote Channels
- $1^{\circ}\text{C}$  Resolution/ $1^{\circ}\text{C}$  Accuracy on Local Channel
- Automatically Cancels Up to 1.5 k $\Omega$  (Typ) of Resistance in Series with the Remote Sensors
- Extended, Switchable Temperature Measurement Range  
 $0^{\circ}\text{C}$  to  $+127^{\circ}\text{C}$  (Default) or  $-55^{\circ}\text{C}$  to  $+150^{\circ}\text{C}$
- 2-wire SMBus Serial Interface with SMBus Alert Support
- Programmable Over/Undertemperature Limits
- Offset Registers for System Calibration
- Up to 2 Overtemperature Fail-Safe THERM Outputs
- Small, 10-lead MSOP Package
- 240  $\mu\text{A}$  Operating Current, 5  $\mu\text{A}$  Standby Current
- This Device is Pb-Free, Halogen Free and is RoHS Compliant

### Applications

- Desktop and Notebook Computers
- Industrial Controllers
- Smart Batteries
- Automotive
- Embedded Systems
- Burn-in Applications
- Instrumentation



ON Semiconductor®

<http://onsemi.com>

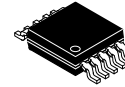

MSOP-10  
CASE 846AC

### PIN ASSIGNMENT

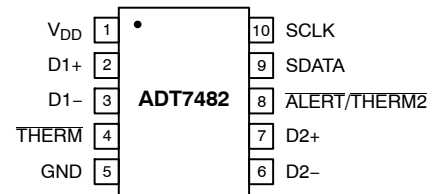

### MARKING DIAGRAM

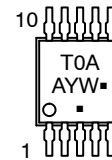

T0A = Device Code  
A = Assembly Location  
Y = Year  
W = Work Week  
▪ = Pb-Free Package

(Note: Microdot may be in either location)

### ORDERING INFORMATION

See detailed ordering and shipping information in the package dimensions section on page 19 of this data sheet.

# ADT7482

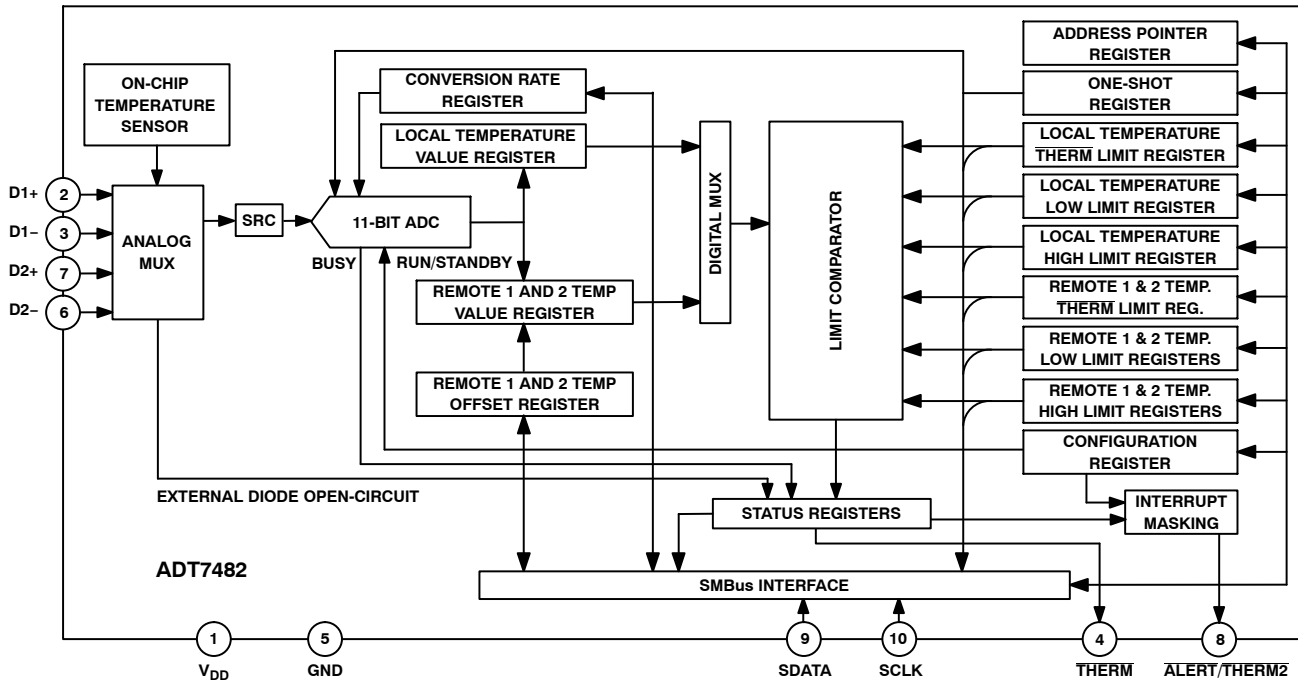

**Figure 1. Functional Block Diagram**

**Table 1. ABSOLUTE MAXIMUM RATINGS**

Parameter	Rating	Unit
Positive Supply Voltage ( $V_{DD}$ ) to GND	-0.3 to +3.6	V
D+	-0.3 to $V_{DD} + 0.3$	V
D- to GND	-0.3 to +0.6	V
SCLK, SDATA, $\overline{\text{ALERT}}$ , $\overline{\text{THERM}}$	-0.3 to +3.6	V
Input Current, SDATA, $\overline{\text{THERM}}$	-1 to +50	mA
Input Current, D-	$\pm 1$	mA
ESD Rating, All Pins (Human Body Model)	2,000	V
Maximum Junction Temperature ( $T_{J \text{ MAX}}$ )	150	$^{\circ}\text{C}$
Storage Temperature Range	-65 to +150	$^{\circ}\text{C}$
IR Reflow Peak Temperature	220	$^{\circ}\text{C}$
IR Reflow Peak Temperature for Pb-Free	260	$^{\circ}\text{C}$
Lead Temperature, Soldering (10 sec)	300	$^{\circ}\text{C}$

Stresses exceeding Maximum Ratings may damage the device. Maximum Ratings are stress ratings only. Functional operation above the Recommended Operating Conditions is not implied. Extended exposure to stresses above the Recommended Operating Conditions may affect device reliability.

NOTE: This device is ESD sensitive. Use standard ESD precautions when handling.

**Table 2. THERMAL CHARACTERISTICS** (Note 1)

Package Type	$\theta_{JA}$	$\theta_{JC}$	Unit
10-lead MSOP	142	43.7	$^{\circ}\text{C}/\text{W}$

1.  $\theta_{JA}$  is specified for the worst-case conditions, that is, a device soldered in a circuit board for surface-mount packages.

Table 3. PIN ASSIGNMENT

Pin No.	Mnemonic	Description
1	V <sub>DD</sub>	Positive Supply, 3.0 V to 3.6 V.
2	D1+	Positive Connection to the First Remote (Remote 1) Temperature Sensor.
3	D1-	Negative Connection to the First Remote (Remote 1) Temperature Sensor.
4	THERM	Open-Drain Output. This pin can be used to turn a fan on/off or throttle a CPU clock in the event of an overtemperature condition. Requires pullup resistor.
5	GND	Supply Ground Connection.
6	D2-	Negative Connection to the Second Remote (Remote 2) Temperature Sensor.
7	D2+	Positive Connection to the Second Remote (Remote 2) Temperature Sensor.
8	ALERT/THERM2	Open-Drain Logic Output. This pin is used as interrupt or SMBus alert. May also be configured as a second THERM output. Requires pullup resistor.
9	SDATA	Logic Input/Output, SMBus Serial Data. Open-Drain Output. Requires pullup resistor.
10	SCLK	Logic Input, SMBus Serial Clock. Requires pullup resistor.

Table 4. TIMING SPECIFICATIONS (Note 1)

Parameter	Limit at T <sub>MIN</sub> and T <sub>MAX</sub>	Unit	Description
f <sub>SCLK</sub>	400	kHz max	
t <sub>LOW</sub>	1.3	μs min	Clock Low Period, between 10% Points
t <sub>HIGH</sub>	0.6	μs min	Clock High Period, between 90% Points
t <sub>R</sub>	300	μs max	Clock/Data Rise Time
t <sub>F</sub>	300	ns max	Clock/Data Fall Time
t <sub>SU; STA</sub>	600	μs min	Start Condition Setup Time
t <sub>HD; STA</sub> (Note 2)	600	μs min	Start Condition Hold Time
t <sub>SU; DAT</sub> (Note 3)	100	ns min	Data Setup Time
t <sub>SU; STO</sub> (Note 4)	600	μs min	Stop Condition Setup Time
t <sub>BUF</sub>	1.3	μs min	Bus Free Time between Stop and Start Conditions

1. Guaranteed by design, not production tested.
2. Time from 10% of SDATA to 90% of SCLK.
3. Time for 10% or 90% of SDATA to 10% of SCLK.
4. Time for 90% of SCLK to 10% of SDATA.

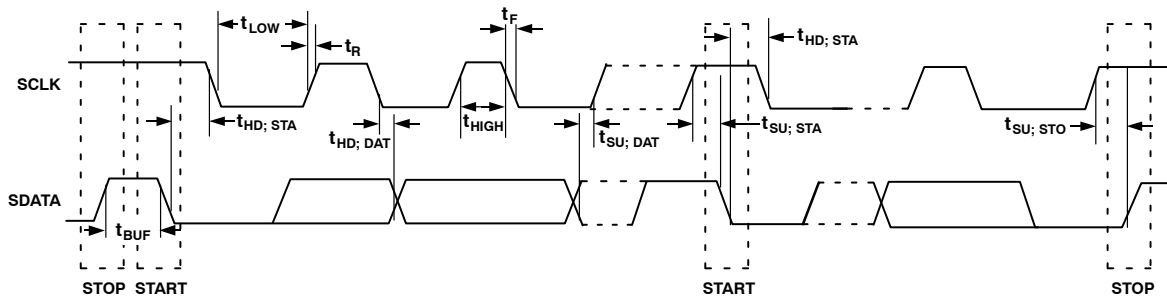

Figure 2. Serial Bus Timing

# ADT7482

**Table 5. ELECTRICAL CHARACTERISTICS** ( $T_A = -40^{\circ}\text{C}$  to  $+120^{\circ}\text{C}$ ,  $V_{DD} = 3.0\text{ V}$  to  $3.6\text{ V}$ , unless otherwise noted.)

Parameter	Test Conditions	Min	Typ	Max	Unit
<b>Power Supply</b>					
Supply Voltage, $V_{DD}$		3.0	3.30	3.6	V
Average Operating Supply Current, $I_{DD}$	0.0625 Conversions/Sec Rate (Note 1)	–	240	350	$\mu\text{A}$
	Standby Mode	–	5.0	30	$\mu\text{A}$
Undervoltage Lockout Threshold	$V_{DD}$ Input, Disables ADC, Rising Edge	–	2.55	–	V
Power-On Reset Threshold		1.0	–	2.5	V
<b>Temperature-to-Digital Converter</b>					
Local Sensor Accuracy	$0^{\circ}\text{C} \leq T_A \leq +70^{\circ}\text{C}$	–	–	$\pm 1.0$	$^{\circ}\text{C}$
	$0^{\circ}\text{C} \leq T_A \leq +85^{\circ}\text{C}$	–	–	$\pm 1.5$	
	$-40^{\circ}\text{C} \leq T_A \leq +100^{\circ}\text{C}$	–	–	$\pm 2.5$	
Resolution		–	1.0	–	$^{\circ}\text{C}$
Remote Diode Sensor Accuracy (Note 2)	$0^{\circ}\text{C} \leq T_A \leq +70^{\circ}\text{C}$ , $-55^{\circ}\text{C} \leq T_D \leq +150^{\circ}\text{C}$	–	–	$\pm 1.0$	$^{\circ}\text{C}$
	$0^{\circ}\text{C} \leq T_A \leq +85^{\circ}\text{C}$ , $-55^{\circ}\text{C} \leq T_D \leq +150^{\circ}\text{C}$	–	–	$\pm 1.5$	
	$-40^{\circ}\text{C} \leq T_A \leq +100^{\circ}\text{C}$ , $-55^{\circ}\text{C} \leq T_D \leq +150^{\circ}\text{C}$	–	–	$\pm 2.5$	
Resolution		–	0.25	–	$^{\circ}\text{C}$
Remote Sensor Source Current	High Level (Note 3)	–	220	–	$\mu\text{A}$
	Mid Level (Note 3)	–	82	–	
	Low Level (Note 2)	–	13.5	–	
Maximum Series Resistance Cancelled	Resistance Split Evenly on D+ and D– Lines	–	1.5	–	$\text{k}\Omega$
Conversion Time	From Stop Bit to Conversion Complete (All Channels) One-shot Mode with Averaging Switched On	–	71	93	ms
	One-shot Mode with Averaging Off (Conversion Rate = 16, 32, or 64 Conversions per Second)	–	11.5	15	ms
<b>Open-Drain Digital Outputs (THERM, ALERT / THERM2)</b>					
Output Low Voltage, $V_{OL}$	$I_{OUT} = -6.0\text{ mA}$	–	–	0.4	V
High Level Output Leakage Current, $I_{OH}$	$V_{OUT} = V_{DD}$	–	0.1	1.0	$\mu\text{A}$
<b>SMBus Interface</b> (Note 3 and 4)					
Logic Input High Voltage, $V_{IH}$ SCLK, SDATA		2.1	–	–	V
Logic Input Low Voltage, $V_{IL}$ SCLK, SDATA		–	–	0.8	V
Hysteresis		–	500	–	mV
SDA Output Low Voltage, $V_{OL}$	$I_{OUT} = -6.0\text{ mA}$	–	–	0.4	V
Logic Input Current, $I_{IH}$ , $I_{IL}$		–1.0	–	+1.0	$\mu\text{A}$
SMBus Input Capacitance, SCLK, SDATA		–	5.0	–	pF
SMBus Clock Frequency		–	–	400	kHz
SMBus Timeout (Note 5)	User Programmable	–	25	64	ms
SCLK Falling Edge to SDATA Valid Time	Master Clocking in Data	–	–	1.0	$\mu\text{s}$

1. See Table 11 for conversion rates.
2. Guaranteed by characterization, but not production tested.
3. Guaranteed by design, but not production tested.
4. See the Timing Specifications section for more information.
5. Disabled by default. For details on enabling the SMBus, see the Serial Bus Interface section.

TYPICAL PERFORMANCE CHARACTERISTICS

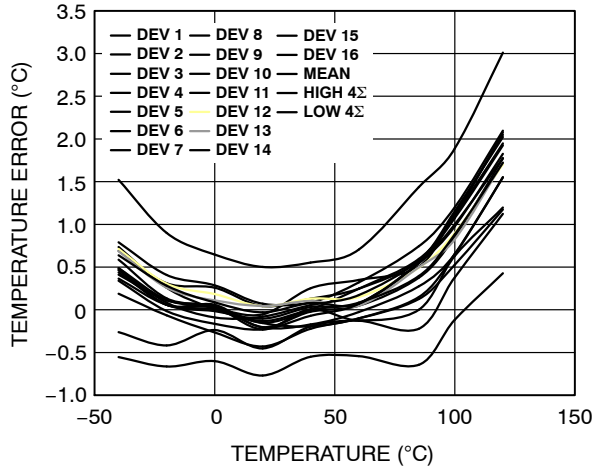

Figure 3. Local Temperature Error vs. Temperature

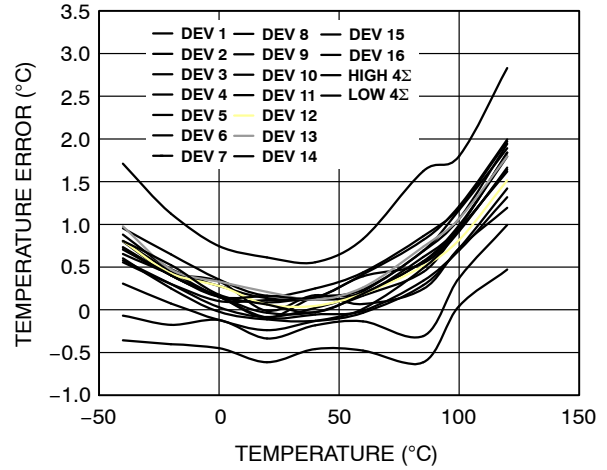

Figure 4. Remote 1 Temperature Error vs. Temperature

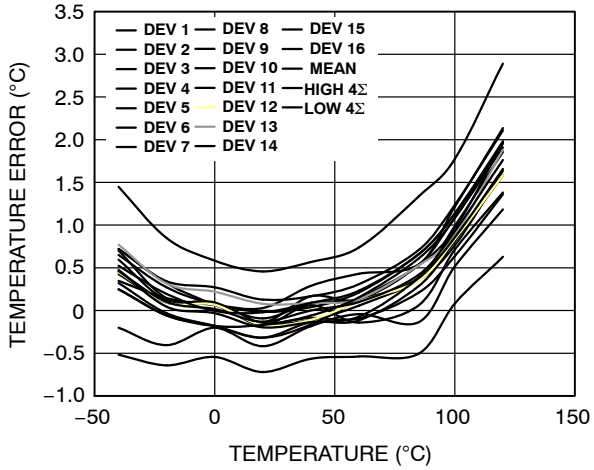

Figure 5. Remote 2 Temperature Error vs. Temperature

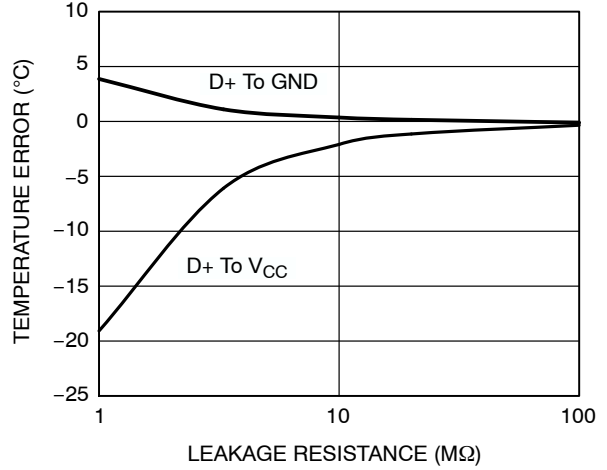

Figure 6. Temperature Error vs. D+/D- Leakage Resistance

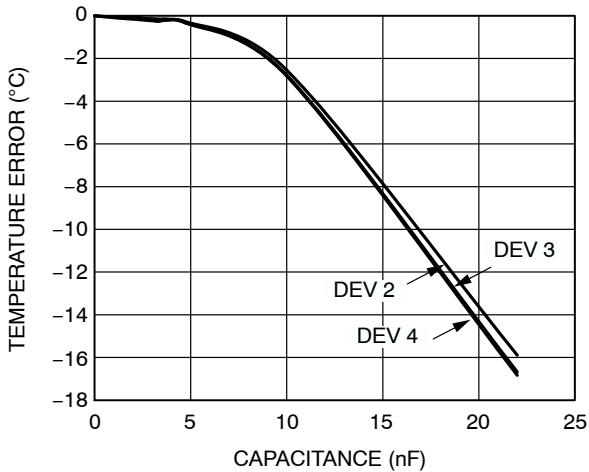

Figure 7. Temperature Error vs. D+/D- Capacitance

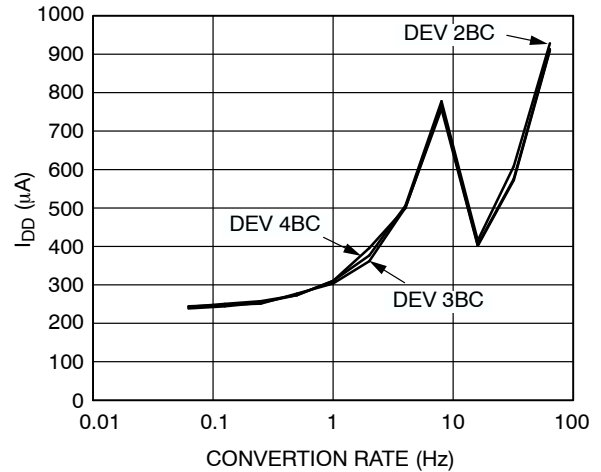

Figure 8. Operating Supply Current vs. Conversion Rate

TYPICAL PERFORMANCE CHARACTERISTICS (Cont'd)

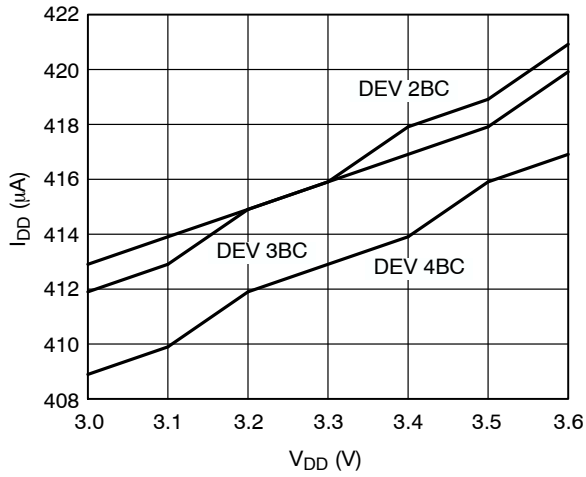

Figure 9. Operating Supply Current vs. Voltage

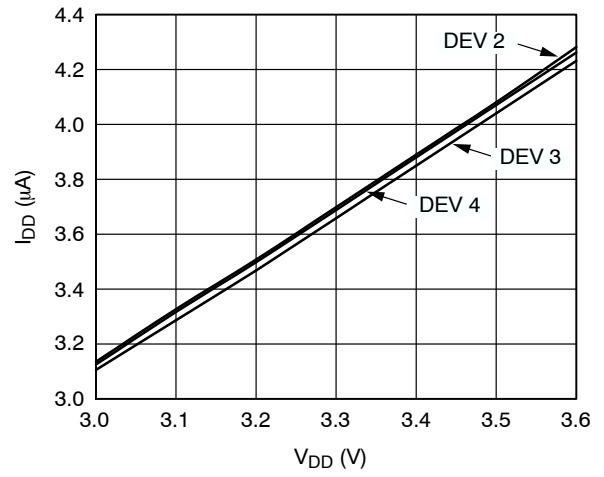

Figure 10. Standby Supply Current vs. Voltage

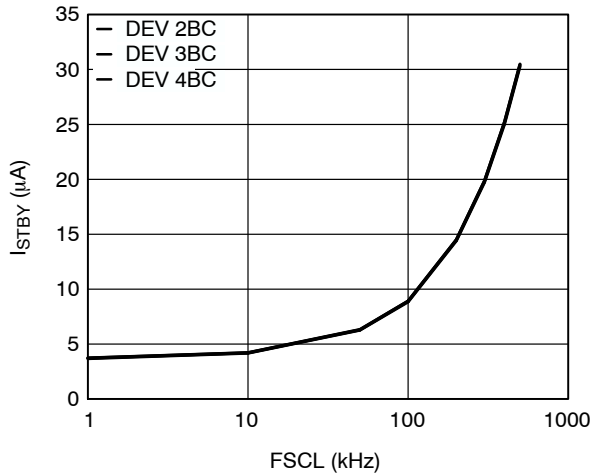

Figure 11. Standby Supply Current vs. SCLK Frequency

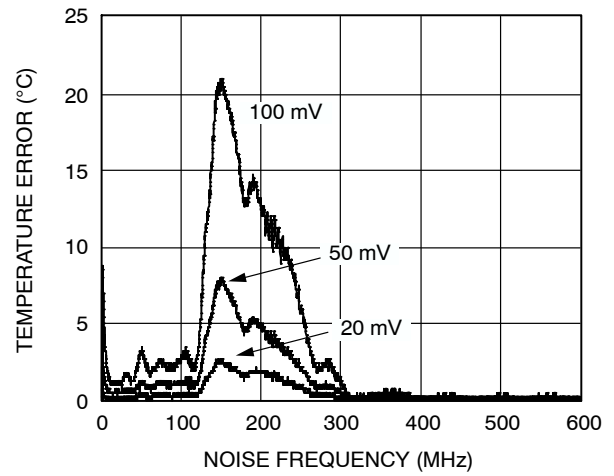

Figure 12. Temperature Error vs. Common-Mode Noise Frequency

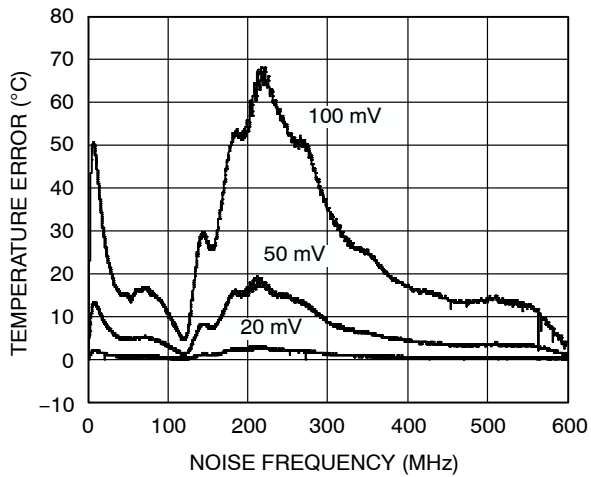

Figure 13. Temperature Error vs. Differential Mode Noise Frequency

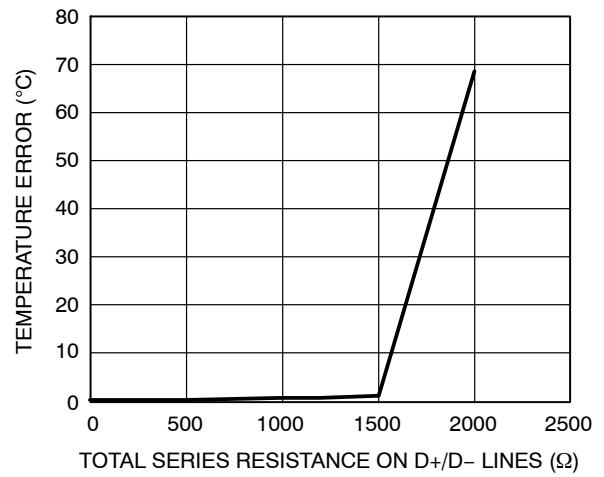

Figure 14. Temperature Error vs. Series Resistance

### Theory of Operation

The ADT7482 is a local and 2× remote temperature sensor and overtemperature/undertemperature alarm. When the ADT7482 is operating normally, the on-board ADC operates in a free-running mode. The analog input multiplexer alternately selects either the on-chip temperature sensor to measure its local temperature or either of the remote temperature sensors. The ADC digitizes these signals and the results are stored in the local, Remote 1, and Remote 2 temperature value registers.

The local and remote measurement results are compared with the corresponding high, low, and  $\overline{\text{THERM}}$  temperature limits, stored in on-chip registers. Out-of-limit comparisons generate flags that are stored in the status register. A result that exceeds the high temperature limit, the low temperature limit, or a remote diode open circuit causes the  $\overline{\text{ALERT}}$  output to assert low. Exceeding  $\overline{\text{THERM}}$  temperature limits causes the  $\overline{\text{THERM}}$  output to assert low. The  $\overline{\text{ALERT}}$  output can be reprogrammed as a second  $\overline{\text{THERM}}$  output.

The limit registers can be programmed, and the device controlled and configured, via the serial SMBus. The contents of any register can also be read back via the SMBus.

Control and configuration functions consist of switching the device between normal operation and standby mode, selecting the temperature measurement scale, masking or enabling the  $\overline{\text{ALERT}}$  output, switching Pin 8 between  $\overline{\text{ALERT}}$  and  $\overline{\text{THERM2}}$ , and selecting the conversion rate.

### Series Resistance Cancellation

Parasitic resistance to the D+ and D− inputs to the ADT7482, seen in series with the remote diode, is caused by a variety of factors, including PCB track resistance and track length. This series resistance appears as a temperature offset in the remote sensor temperature measurement. This error typically causes a 0.5°C offset per ohm of parasitic resistance in series with the remote diode.

The ADT7482 automatically cancels out the effect of this series resistance on the temperature reading, providing a more accurate result, without the need for user characterization of this resistance. The ADT7482 is designed to automatically cancel typically up to 1.5 kΩ of resistance. By using an advanced temperature measurement method, this is transparent to the user. This feature allows resistances to be added to the sensor path to produce a filter, allowing the part to be used in noisy environments. See the Noise Filtering section for more details.

### Temperature Measurement Method

A simple method of measuring temperature is to exploit the negative temperature coefficient of a diode, measuring the base-emitter voltage ( $V_{BE}$ ) of a transistor operated at constant current. However, this technique requires calibration to null out the effect of the absolute value of  $V_{BE}$ , which varies from device to device.

The technique used in the ADT7482 is to measure the change in  $V_{BE}$  when the device is operated at three different currents. Previous devices have used only two operating currents. The use of a third current allows automatic cancellation of resistances in series with the external temperature sensor.

Figure 15 shows the input signal conditioning used to measure the output of an external temperature sensor. This figure shows the external sensor as a substrate transistor, but it could equally be a discrete transistor. If a discrete transistor is used, the collector is not grounded and should be linked to the base. To prevent ground noise from interfering with the measurement, the more negative terminal of the sensor is not referenced to ground, but is biased above ground by an internal diode at the D− input. Capacitor C1 can be added as a noise filter (a recommended maximum value of 1,000 pF). However, a better option in noisy environments is to add a filter, as described in the Noise Filtering section. See the Layout Considerations section for more information.

To measure  $\Delta V_{BE}$ , the operating current through the sensor is switched among three related currents. Shown in Figure 15,  $N1 \times I$  and  $N2 \times I$  are different multiples of the current,  $I$ . The currents through the temperature diode are switched between  $I$  and  $N1 \times I$ , giving  $\Delta V_{BE1}$ , and then between  $I$  and  $N2 \times I$ , giving  $\Delta V_{BE2}$ . The temperature can then be calculated using the two  $\Delta V_{BE}$  measurements. This method can also be shown to cancel the effect of any series resistance on the temperature measurement.

The resulting  $\Delta V_{BE}$  waveforms are passed through a 65 kHz low-pass filter to remove noise and then to a chopper-stabilized amplifier. This amplifies and rectifies the waveform to produce a dc voltage proportional to  $\Delta V_{BE}$ . The ADC digitizes this voltage and a temperature measurement is produced. To reduce the effects of noise, digital filtering is performed by averaging the results of 16 measurement cycles for low conversion rates. At rates of 16, 32, and 64 conversions/second, no digital averaging takes place.

Signal conditioning and measurement of the internal temperature sensor are performed in the same manner.



# ADT7482

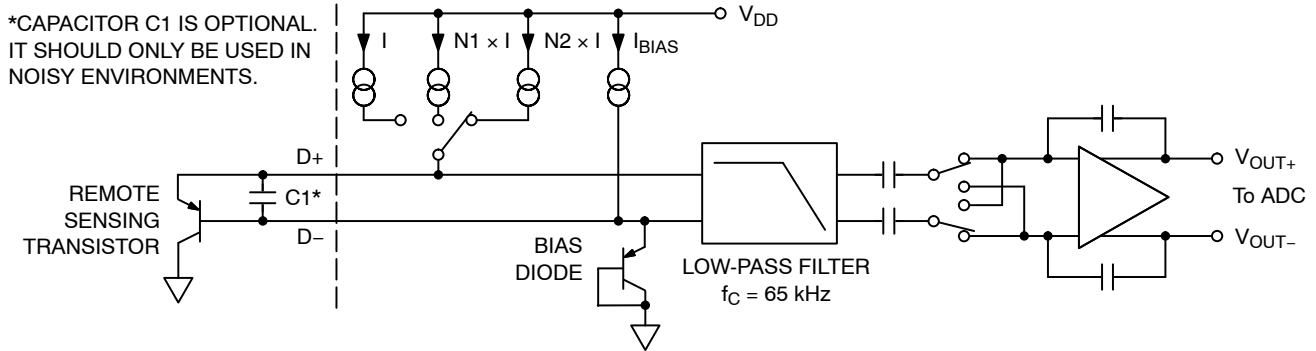

Figure 15. Input Signal Conditioning

## Temperature Measurement Results

The results of the local and remote temperature measurements are stored in the local and remote temperature value registers and are compared with limits programmed into the local and remote high and low limit registers.

The local temperature measurement is an 8-bit measurement with 1°C resolution. The remote temperature measurements are 10-bit measurements, with the 8 MSBs stored in one register and the 2 LSBs stored in another register. Table 6 is a list of the temperature measurement registers.

Table 6. REGISTER ADDRESS FOR THE TEMPERATURE VALUES

Temperature Channel	Register Address, MSBs	Register Address, LSBs
Local	0x00	N/A
Remote 1	0x01	0x10 (2 MSBs)
Remote 2	0x30	0x33 (2 MSBs)

Set Bit 3 of the Configuration 1 register to 1, to read the Remote 2 temperature values from the following register addresses:

Remote 2, MSBs = 0x01  
 Remote 2, LSBs = 0x10

The above is true only when Bit 3 of the Configuration 1 register is set. To read the Remote 1 temperatures, switch this bit back to 0.

Only the two MSBs in the remote temperature low byte are used. This gives the remote temperature measurement a resolution of 0.25°C. Table 7 shows the data format for the remote temperature low byte.

Table 7. EXTENDED TEMPERATURE RESOLUTION (REMOTE TEMPERATURE LOW BYTE)

Extended Resolution	Remote Temperature Low Byte
0.00°C	0 000 0000
0.25°C	0 100 0000
0.50°C	1 000 0000
0.75°C	1 100 0000

When reading the full remote temperature value, both the high and low byte, the two registers should be read LSB first and then MSB. Reading the LSB causes the MSB to be locked until it is read. This guarantees that the two values are read as a result of the same temperature measurement.

## Temperature Measurement Range

The temperature measurement range for both local and remote measurements is, by default, 0°C to +127°C. However, the ADT7482 can be operated using an extended temperature range. It can measure the full temperature range of a remote thermal diode, from -55°C to +150°C. Switch between these two temperature ranges by setting or clearing Bit 2 in the Configuration 1 register. A valid result is available in the next measurement cycle after changing the temperature range.

In extended temperature mode, the upper and lower temperature measured by the ADT7482 is limited by the remote diode selection. The temperature registers themselves can have values from -64°C to +191°C. However, most temperature-sensing diodes have a maximum temperature range of -55°C to +150°C.

Note that while both local and remote temperature measurements can be made while the part is in extended temperature mode, the ADT7482 itself should not be exposed to temperatures greater than those specified in the Absolute Maximum Ratings section. Further, the device is only guaranteed to operate as specified at ambient temperatures from -40°C to +120°C.

## Temperature Data Format

When the measurement range is in extended mode, an offset binary data format is used for both local and remote results. Temperature values in the offset binary data format are offset by +64. Examples of temperatures in both data formats are shown in Table 8.

Switching between measurement ranges can be done at any time. Switching the range also switches the data format. The next temperature result following the switching is reported back to the register in the new format. However, the contents of the limit registers do not change. Ensure that when the data format changes, the limit registers are reprogrammed as necessary. For more information, refer to the Limit Registers section.

The ADT7482 has two temperature data formats. When the temperature measurement range is from 0°C to 127°C (default), the temperature data format for both local and remote temperature results is binary.

**Table 8. TEMPERATURE DATA FORMAT (LOCAL AND REMOTE TEMPERATURE HIGH BYTE)**

Temperature	Binary	Offset Binary (Note 1)
-55°C	0 000 0000 (Note 2)	0 000 1001
0°C	0 000 0000	0 100 0000
+1°C	0 000 0001	0 100 0001
+10°C	0 000 1010	0 100 1010
+25°C	0 001 1001	0 101 1001
+50°C	0 011 0010	0 111 0010
+75°C	0 100 1011	1 000 1011
+100°C	0 110 0100	1 010 0100
+125°C	0 111 1101	1 011 1101
+127°C	0 111 1111	1 011 1111
+150°C	0 111 1111 (Note 3)	1 101 0110

1. Offset binary scale temperature values are offset by +64.
2. Binary scale temperature measurement returns 0 for all temperatures < 0°C.
3. Binary scale temperature measurement returns 127 for all temperatures > 127°C.

### Registers

The registers in the ADT7482 are 8-bits wide. These registers are used to store the results of remote and local temperature measurements and high and low temperature limits and to configure and control the device. A description of these registers follows.

### Address Pointer Register

The address pointer register itself does not have, or require, an address, as the first byte of every write operation is automatically written to this register. The data in this first byte always contains the address of another register on the ADT7482, which is stored in the address pointer register. It

is to this register address that the second byte of a write operation is written to or to which a subsequent read operation is performed.

The power-on default value of the address pointer register is 0x00. Therefore, if a read operation is performed immediately after power-on, without first writing to the address pointer, the value of the local temperature is returned, since its register address is 0x00.

### Configuration Registers

There are two configuration registers used to control the operation of the ADT7482. Configuration 1 register is at Address 0x03 for reads and Address 0x09 for writes. See Table 9 for details regarding the operation of this register. Configuration 2 Register is at Address 0x24 for both reads and writes. Setting Bit 7 of this register locks all lockable registers. The affected registers can only be modified if the ADT7482 is powered down and powered up again. See Table 16 for a list of the registers affected by the lock bit.

### Temperature Value Registers

The ADT7482 has five registers to store the results of local and remote temperature measurements. These registers can only be written to by the ADC and can be read over the SMBus.

- The local temperature value register is at Address 0x00.
- The Remote 1 temperature value high byte register is at Address 0x01; the Remote 1 low byte register is at Address 0x10.
- The Remote 2 temperature value high byte register is at Address 0x30; the Remote 2 low byte register is at Address 0x33.
- The Remote 2 temperature values can be read from Addresses 0x01 for the high byte and Address 0x10 for the low byte if Bit 3 of Configuration Register 1 is set to 1.
- To read the Remote 1 temperature values, set Bit 3 of Configuration Register 1 to 0.
- The power-on default for all five registers is 0x00.

**Table 9. CONFIGURATION 1 REGISTER (READ ADDRESS 0x03, WRITE ADDRESS 0x09)**

Bit	Mnemonic	Function
7	Mask	Setting this bit to 1 masks all ALERTs on the ALERT pin. Default = 0 = ALERT enabled. This applies only if Pin 8 is configured as ALERT, otherwise it has no effect.
6	Mon/STBY	Setting this bit to 1 places the ADT7482 in standby mode, that is, it suspends all temperature measurements (ADC). The SMBus remains active and values can be written to, and read from, the registers. THERM and ALERT are also active in standby mode. Changes made to the limit registers in standby mode that effect the THERM or ALERT outputs cause these signals to be updated. Default = 0 = temperature monitoring enabled.
5	AL/TH	This bit selects the function of Pin 8. Default = 0 = ALERT. Setting this bit to 1 configures Pin 8 as the THERM2 pin.
4	Reserved	Reserved for future use.
3	Remote 1 /Remote2	Setting this bit to 1 enables the user to read the Remote 2 values from the Remote 1 registers. When default = 0, Remote 1 temperature values and limits are read from these registers.
2	Temp Range	Setting this bit to 1 enables the extended temperature measurement range of -50°C to +150°C. Default = 0 = 0°C to +127°C.
1	Mask R1	Setting this bit to 1 masks ALERTs due to the Remote 1 temperature exceeding a programmed limit. Default = 0.
0	Mask R2	Setting this bit to 1 masks ALERTs due to the Remote 2 temperature exceeding a programmed limit. Default = 0.

**Table 10. CONFIGURATION 2 REGISTER (ADDRESS 0x24)**

Bit	Mnemonic	Function
7	Lock Bit	Setting this bit to 1 locks all lockable registers to their current values. This prevents tampering with settings until the device is powered down. Default = 0.
<6:0>	Res	Reserved for future use.

**Conversion Rate Register**

The conversion rate register is at Address 0x04 for reads and Address 0x0A for writes. The four LSBs of this register are used to program the conversion times from 15.5 ms (Code 0x0A) to 16 seconds (Code 0x00). To program the ADT7482 to perform continuous measurements, set the conversion rate register to 0x0B. For example, a conversion rate of 8 conversions/second means that, beginning at 125 ms intervals, the device performs a conversion on the local and the remote temperature channels. The four MSBs of this register are reserved and should not be written to.

This register can be written to and read back over the SMBus. The default value of this register is 0x07, giving a rate of 8 conversions per second. Use of slower conversion times greatly reduces the device power consumption.

**Limit Registers**

The ADT7482 has three limits for each temperature channel: high, low, and THERM temperature limits for local, Remote 1, and Remote 2 temperature measurements. The remote temperature high and low limits span two registers each, to contain an upper and lower byte for each limit. There is also a THERM hysteresis register. All limit registers can be written to and read back over the SMBus. See Table 16 for limit register addresses and power-on default values.

When Pin 8 is configured as an ALERT output, the high limit registers perform a > comparison while the low limit registers perform a ≤ comparison. For example, if the high limit register is programmed with 80°C, then measuring 81°C results in an out-of-limit condition, setting a flag in the status register. If the low limit register is programmed with 0°C, measuring 0°C or lower results in an out-of-limit condition.

Exceeding either the local or remote THERM limit asserts THERM low. When Pin 8 is configured as THERM2, exceeding either the local or remote high limit asserts THERM2 low. A default hysteresis value of 10°C is provided that applies to both THERM channels. This hysteresis value can be reprogrammed.

It is important to remember that the temperature limits data format is the same as the temperature measurement data format. If the temperature measurement uses the default binary scale, then the temperature limits also use the binary scale. If the temperature measurement scale is switched, however, the temperature limits do not switch automatically.

The limit registers must be reprogrammed to the desired value in the correct data format. For example, if the remote low limit is set at 10°C and the default binary scale is used, the limit register value should be 0000 1010b. If the scale is switched to offset binary, the value in the low temperature limit register should be reprogrammed to be 0100 1010b.

**Table 11. CONVERSION RATE/CHANNEL SELECTOR REGISTER (READ ADDRESS 0x04, WRITE ADDRESS 0x0A)**

Bit	Mnemonic	Function																								
7	Reserved	Reserved for Future Use. Do Not Write to this Bit.																								
6	Reserved	Reserved for Future Use. Do Not Write to this Bit.																								
5	Reserved	Reserved for Future Use. Do Not Write to this Bit.																								
4	Reserved	Reserved for Future Use. Do Not Write to this Bit.																								
<3:0>	Conversion Rates	<p>These Bits Set how often the ADT7482 Measures each Temperature Channel.</p> <table> <thead> <tr> <th>Conversions/sec</th> <th>Time (seconds)</th> </tr> </thead> <tbody> <tr> <td>0000 = 0.0625</td> <td>16</td> </tr> <tr> <td>0001 = 0.125</td> <td>8</td> </tr> <tr> <td>0010 = 0.25</td> <td>4</td> </tr> <tr> <td>0011 = 0.5</td> <td>2</td> </tr> <tr> <td>0100 = 1</td> <td>1</td> </tr> <tr> <td>0101 = 2</td> <td>500 m</td> </tr> <tr> <td>0110 = 4</td> <td>250 m</td> </tr> <tr> <td>0111 = 8 = Default</td> <td>125 m</td> </tr> <tr> <td>1000 = 16</td> <td>62.5 m</td> </tr> <tr> <td>1001 = 32</td> <td>31.25 m</td> </tr> <tr> <td>1010 = 64</td> <td>15.5 m</td> </tr> </tbody> </table>	Conversions/sec	Time (seconds)	0000 = 0.0625	16	0001 = 0.125	8	0010 = 0.25	4	0011 = 0.5	2	0100 = 1	1	0101 = 2	500 m	0110 = 4	250 m	0111 = 8 = Default	125 m	1000 = 16	62.5 m	1001 = 32	31.25 m	1010 = 64	15.5 m
Conversions/sec	Time (seconds)																									
0000 = 0.0625	16																									
0001 = 0.125	8																									
0010 = 0.25	4																									
0011 = 0.5	2																									
0100 = 1	1																									
0101 = 2	500 m																									
0110 = 4	250 m																									
0111 = 8 = Default	125 m																									
1000 = 16	62.5 m																									
1001 = 32	31.25 m																									
1010 = 64	15.5 m																									

## Status Registers

The status registers are read-only registers at Addresses 0x02 (Status Register 1) and Address 0x23 (Status Register 2). They contain status information for the ADT7482.

**Table 12. STATUS REGISTER 1 BIT ASSIGNMENTS**

Bit	Mnemonic	Function	ALERT
7	BUSY	1 when ADC Converting	No
6	LHIGH (Note 1)	1 when Local High Temperature Limit Tripped	Yes
5	LLOW (Note 1)	1 when Local Low Temperature Limit Tripped	Yes
4	R1HIGH (Note 1)	1 when Remote 1 High Temperature Limit Tripped	Yes
3	R1LOW (Note 1)	1 when Remote 1 Low Temperature Limit Tripped	Yes
2	D1 OPEN (Note 1)	1 when Remote 1 Sensor Open Circuit	Yes
1	R1THRM1	1 when Remote 1 THERM Limit Tripped	No
0	LTHRM1	1 when Local THERM Limit Tripped	No

1. These flags stay high until the status register is read, or they are reset by POR.

**Table 13. STATUS REGISTER 2 BIT ASSIGNMENTS**

Bit	Mnemonic	Function	ALERT
7	Res	Reserved for Future Use	No
6	Res	Reserved for Future Use	No
5	Res	Reserved for Future Use	No
4	R2HIGH (Note 1)	1 when Remote 2 High Temperature Limit Tripped	Yes
3	R2LOW (Note 1)	1 when Remote 2 Low Temperature Limit Tripped	Yes
2	D2 OPEN (Note 1)	1 when Remote 2 Sensor Open Circuit	Yes
1	R2THRM1	1 when Remote 2 THERM Limit Tripped	No
0	ALERT	1 when ALERT Condition Exists	No

1. These flags stay high until the status register is read, or they are reset by POR.

The eight flags that can generate an  $\overline{\text{ALERT}}$  are NOR'd together. When any flags are high, the  $\overline{\text{ALERT}}$  interrupt latch is set and the  $\overline{\text{ALERT}}$  output goes low (provided they are not masked out).

Reading the Status 1 register clears the 5 flags, (Bit 6 through Bit 2) in Status Register 1, provided the error conditions that caused the flags to be set have gone away. Reading the Status 2 Register clears the three flags, (Bit 4 through Bit 2) in Status Register 2, provided the error conditions that caused the flags to be set have gone away. A flag bit can only be reset if the corresponding value register contains an in-limit measurement or if the sensor is good.

The  $\overline{\text{ALERT}}$  interrupt latch is not reset by reading the status register. It is reset when the  $\overline{\text{ALERT}}$  output has been serviced by the master reading the device address, provided the error condition has gone away and the status register flag bits have been reset.

When Flag 1 and/or Flag 0 of Status Register 1 or Flag 1 of Status Register 2 are set, the  $\overline{\text{THERM}}$  output goes low to indicate that the temperature measurements are outside the programmed limits. The  $\overline{\text{THERM}}$  output does not need to be reset, unlike the  $\overline{\text{ALERT}}$  output. Once the measurements are within the limits, the corresponding status register bits are reset automatically, and the  $\overline{\text{THERM}}$  output goes high. To add hysteresis, program Register 0x21. The  $\overline{\text{THERM}}$  output is reset only when the temperature falls below the  $\overline{\text{THERM}}$  limit minus hysteresis.

When Pin 8 is configured as  $\overline{\text{THERM2}}$ , only the high temperature limits are relevant. If Flag 6 or Flag 4 of Status Register 1 or Flag 4 of Status Register 2 are set, the  $\overline{\text{THERM2}}$  output goes low to indicate that the temperature measurements are outside the programmed limits. Flag 5 and Flag 3 of Status Register 1 and Flag 3 of Status Register 2 have no effect on  $\overline{\text{THERM2}}$ . The behavior of  $\overline{\text{THERM2}}$  is otherwise the same as  $\overline{\text{THERM}}$ .

Bit 0 of the Status Register 2 is set whenever the ADT7482  $\overline{\text{ALERT}}$  output is asserted low. Read Status Register 2 to determine if the ADT7482 is responsible for the  $\overline{\text{ALERT}}$ . This bit is reset when the  $\overline{\text{ALERT}}$  output is reset. If the  $\overline{\text{ALERT}}$  output is masked, then this bit is not set.

## Offset Register

Offset errors can be introduced into the remote temperature measurement by clock noise or by the thermal diode being located away from the hot spot. To achieve the specified accuracy on this channel, these offsets must be removed.

The offset values are stored as 10-bit, twos complement values.

- The Remote 1 Offset MSBs are stored in Register 0x11 and the LSBs are stored in Register 0x12 (low byte, left justified). The Remote 2 Offset MSBs are stored in Register 0x34 and the LSBs are stored in Register 0x35 (low byte, left justified).
- The Remote 2 Offset can be written to or read from the Remote 1 Offset Registers if Bit 3 of the Configuration 1 register is set to 1. This bit should be set to 0 (default) to read the Remote 1 offset values.

Only the upper 2 bits of the LSB registers are used. The MSB of MSB offset registers is the sign bit. The minimum offset that can be programmed is  $-128^{\circ}\text{C}$ , and the maximum is  $+127.75^{\circ}\text{C}$ . The value in the offset register is added or subtracted to the measured value of the remote temperature.

The offset register powers up with a default value of  $0^{\circ}\text{C}$  and has no effect unless a different value is written to it.

Table 14. SAMPLE OFFSET REGISTER CODES

Offset Value	0x11/0x34	0x12/0x35
-128°C	1000 0000	00 00 0000
-4°C	1111 1100	00 00 0000
-1°C	1111 1111	00 000000
-0.25°C	1111 1111	10 00 0000
0°C	0000 0000	00 00 0000
+0.25°C	0000 0000	01 00 0000
+1°C	0000 0001	00 00 0000
+4°C	0000 0100	00 00 0000
+127.75°C	0111 1111	11 00 0000

### One-shot Register

The one-shot register initiates a conversion and comparison cycle when the ADT7482 is in standby mode, after which the device returns to standby. Writing to the one-shot register address (0x0F) causes the ADT7482 to perform a conversion and comparison on both the local and the remote temperature channels. This is not a data register as such, and it is the write operation to Address 0x0F that causes the one-shot conversion. The data written to this address is irrelevant and is not stored.

Table 16. LIST OF REGISTERS

Read Address (Hex)	Write Address (Hex)	Mnemonic	Power-On Default	Comment	Lock
N/A	N/A	Address Pointer	Undefined		No
00	N/A	Local Temperature Value	0000 0000 (0x00)		No
01	N/A	Remote 1 Temperature Value High Byte	0000 0000 (0x00)	Bit 3 Conf. Reg. = 0	No
01	N/A	Remote 2 Temperature Value High Byte	0000 0000 (0x00)	Bit 3 Conf. Reg. = 1	No
02	N/A	Status Register 1	Undefined		No
03	09	Configuration Register 1	0000 0000 (0x00)		Yes
04	0A	Conversion Rate	0000 0111 (0x07)		Yes
05	0B	Local Temperature High Limit	0101 0101 (0x55) (85°C)		Yes
06	0C	Local Temperature Low Limit	0000 0000 (0x00) (0°C)		Yes
07	0D	Remote 1 Temperature High Limit High Byte	0101 0101 (0x55) (85°C)	Bit 3 Conf. Reg. = 0	Yes
07	0D	Remote 2 Temperature High Limit High Byte	0101 0101 (0x55) (85°C)	Bit 3 Conf. Reg. = 1	Yes
08	0E	Remote 1 Temperature Low Limit High Byte	0000 0000 (0x00) (0°C)	Bit 3 Conf. Reg. = 0	Yes
08	0E	Remote 2 Temperature Low Limit High Byte	0000 0000 (0x00) (0°C)	Bit 3 Conf. Reg. = 1	Yes
N/A	0F (Note 1)	One Shot			N/A
10	N/A	Remote 1 Temperature Value Low Byte	0000 0000	Bit 3 Conf. Reg. = 0	No
10	N/A	Remote 2 Temperature Value Low Byte	0000 0000	Bit 3 Conf. Reg. = 1	No
11	11	Remote 1 Temperature Offset High Byte	0000 0000	Bit 3 Conf. Reg. = 0	Yes
11	11	Remote 2 Temperature Offset High Byte	0000 0000	Bit 3 Conf. Reg. = 1	Yes
12	12	Remote 1 Temperature Offset Low Byte	0000 0000	Bit 3 Conf. Reg. = 0	Yes
12	12	Remote 2 Temperature Offset Low Byte	0000 0000	Bit 3 Conf. Reg. = 1	Yes
13	13	Remote 1 Temperature High Limit Low Byte	0000 0000	Bit 3 Conf. Reg. = 0	Yes
13	13	Remote 2 Temperature High Limit Low Byte	0000 0000	Bit 3 Conf. Reg. = 1	Yes
14	14	Remote 1 Temperature Low Limit Low Byte	0000 0000	Bit 3 Conf. Reg. = 0	Yes

### Consecutive ALERT Register

The value written to this register determines how many out-of-limit measurements must occur before an **ALERT** is generated. The default value is that one out-of-limit measurement generates an **ALERT**. The maximum value that can be chosen is 4. This register allows some filtering of the output. This is particularly useful at the fastest three conversion rates, where no averaging takes place. This register address is 0x22. For more information, refer to Table 15.

Table 15. CONSECUTIVE ALERT REGISTER BIT

Register Value	Amount of Out-of-Limit Measurements Required
yzax 000x	1
yzax 001x	2
yzax 011x	3
yzax 111x	4

NOTES: y = SMBus SCL timeout bit. Default = 0. See the Serial Bus Interface section for more information.  
z = SMBus SDA timeout bit. Default = 0. See the Serial Bus Interface section for more information.  
a = Mask Internal **ALERT**s.  
x = Don't care bit.

Table 16. LIST OF REGISTERS (continued)

Read Address (Hex)	Write Address (Hex)	Mnemonic	Power-On Default	Comment	Lock
14	14	Remote 2 Temperature Low Limit Low Byte	0000 0000	Bit 3 Conf. Reg. = 1	Yes
19	19	Remote 1 THERM Limit	0101 0101 (0x55) (85°C)	Bit 3 Conf. Reg. = 0	Yes
19	19	Remote 2 THERM Limit	0101 0101 (0x55) (85°C)	Bit 3 Conf. Reg. = 1	Yes
20	20	Local THERM Limit	0101 0101 (0x55) (85°C)		Yes
21	21	THERM Hysteresis	0000 1010 (0x0A) (10°C)		Yes
22	22	Consecutive ALERT	0000 0001 (0x01)		Yes
23	N/A	Status Register 2	0000 0000 (0x00)		No
24	24	Configuration 2 Register	0000 0000 (0x00)		Yes
30	N/A	Remote 2 Temperature Value High Byte	0000 0000 (0x00)		No
31	31	Remote 2 Temperature High Limit High Byte	0101 0101 (0x55) (85°C)		Yes
32	32	Remote 2 Temperature Low Limit High Byte	0000 0000 (0x00) (0°C)		Yes
33	N/A	Remote 2 Temperature Value Low Byte	0000 0000 (0x00)		No
34	34	Remote 2 Temperature Offset High Byte	0000 0000 (0x00)		Yes
35	35	Remote 2 Temperature Offset Low Byte	0000 0000 (0x00)		Yes
36	36	Remote 2 Temperature High Limit Low Byte	0000 0000 (0x00) (0°C)		Yes
37	37	Remote 2 Temperature Low Limit Low Byte	0000 0000 (0x00) (0°C)		Yes
39	39	Remote 2 THERM Limit	0101 0101 (0x55) (85°C)		Yes
FE	N/A	Manufacturer ID	0100 0001 (0x41)		N/A
FF	N/A	Die Revision Code	0110 0101 (0x65)		N/A

- Writing to address 0F causes the ADT7482 to perform a single measurement. It is not a data register as such and it does not matter what data is written to it.

### Serial Bus Interface

Control of the ADT7482 is achieved via the serial bus. The ADT7482 is connected to this bus as a slave device, under the control of a master device.

The ADT7482 has an SMBus timeout feature. When this is enabled, the SMBus times out after typically 25 ms of no activity. However, this feature is not enabled by default. Set Bit 7 (SCL Timeout Bit) of the consecutive alert register (Address = 0x22) to enable the SCL Timeout. Set Bit 6 (SDA Timeout Bit) of the consecutive alert register (Address = 0x22) to enable the SDA Timeout.

Consult the SMBus 1.1 Specification for more information ([www.smbus.org](http://www.smbus.org)).

### Addressing the Device

In general, every SMBus device has a 7-bit device address, except for some devices that have extended, 10-bit addresses. When the master device sends a device address over the bus, the slave device with that address responds. The ADT7482 is available with one device address, 0x4C (1001 100b). The address mentioned in this data sheet is a 7-bit address. The R/W bit needs to be added to arrive at an 8-bit address.

### Serial Bus Protocol Operation

The master initiates data transfer by establishing a start condition, defined as a high-to-low transition on the serial data line SDATA while the serial clock line SCLK remains high. This indicates that an address/data stream follows.

All slave peripherals connected to the serial bus respond to the start condition and shift in the next eight bits, consisting of a 7-bit address (MSB first) plus an R/W bit, which determines the direction of the data transfer, that is, whether data is to be written to or read from the slave device. The peripheral whose address corresponds to the transmitted address responds by pulling the data line low during the low period before the ninth clock pulse, known as the acknowledge bit. All other devices on the bus now remain idle while the selected device waits for data to be read from or written to it. If the R/W bit is a 0, the master writes to the slave device. If the R/W bit is a 1, the master reads from the slave device.

Data is sent over the serial bus in a sequence of nine clock pulses, eight bits of data followed by an acknowledge bit from the slave device. Transitions on the data line must occur during the low period of the clock signal and remain stable during the high period, since a low-to-high transition when the clock is high can be interpreted as a stop signal. The number of data bytes that can be transmitted over the serial bus in a single read or write operation is limited only by what the master and slave devices can handle.

When all data bytes have been read or written, stop conditions are established. In write mode, the master pulls the data line high during the tenth clock pulse to assert a stop condition. In read mode, the master device overrides the acknowledge bit by pulling the data line high during the low period before the ninth clock pulse. This is known as no

## ADT7482

acknowledge. The master then takes the data line low during the low period before the tenth clock pulse, then high during the tenth clock pulse to assert a stop condition.

Any number of bytes of data can be transferred over the serial bus in one operation, but it is not possible to mix read and write in one operation because the type of operation is determined at the beginning and cannot subsequently be changed without starting a new operation. In the case of the ADT7482, write operations contain either one or two bytes, while read operations contain one byte.

To write data to one of the device data registers or to read data from it, the address pointer register must be set so that

the correct data register is addressed. The first byte of a write operation always contains a valid address that is stored in the address pointer register. If data is to be written to the device, the write operation contains a second data byte that is written to the register selected by the address pointer register.

This procedure is illustrated in Figure 16. The device address is sent over the bus followed by R/W set to 0. This is followed by two data bytes. The first data byte is the address of the internal data register to be written to, which is stored in the address pointer register. The second data byte is the data to be written to the internal data register.

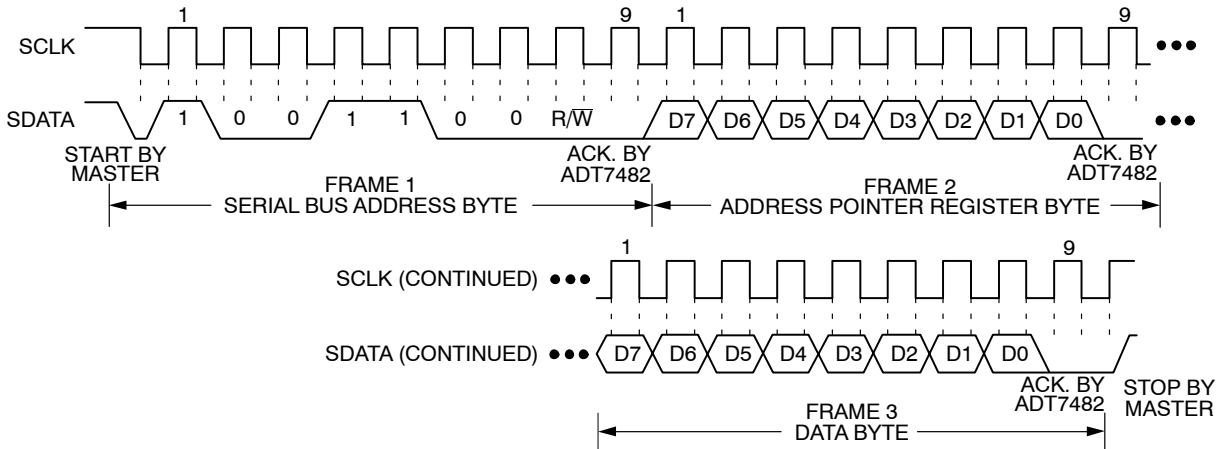

**Figure 16. Writing a Register Address to the Address Pointer Register, then Writing Data to the Selected Register**

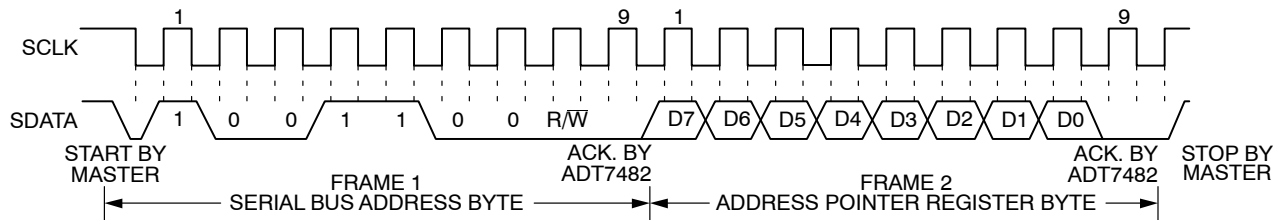

**Figure 17. Writing to the Address Pointer Register Only**

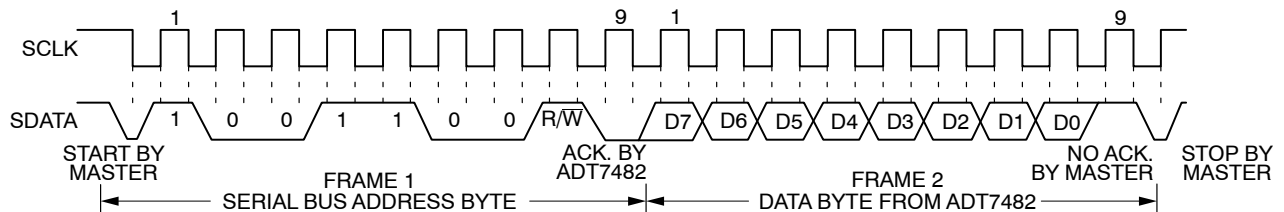

**Figure 18. Reading Data from a Previously Selected Register**

### Reading Data from a Register

When reading data from a register there are two possibilities:

1. If the ADT7482 address pointer register value is unknown or not the desired value, it is first necessary to set it to the correct value before data can be read from the desired data register. This is done by performing a write to the ADT7482 as before, but only the data byte containing the register read address is sent, as data is not to be written to the register. This is shown in Figure 17. A read operation is then performed consisting of the serial bus address, R/W bit set to 1, followed by the data byte read from the data register. This is shown in Figure 18.
2. If the address pointer register is known to be already at the desired address, data can be read from the corresponding data register without first writing to the address pointer register and the bus transaction shown in Figure 17 can be omitted.

When reading data from a register, it is important to note the following points:

- It is possible to read a data byte from a data register without first writing to the address pointer register. However, if the address pointer register is already at the correct value, it is not possible to write data to a register without writing to the address pointer register. This is because the first data byte of a write is always written to the address pointer register.
- Remember that some of the ADT7482 registers have different addresses for read and write operations. The write address of a register must be written to the address pointer if data is to be written to that register, but it may not be possible to read data from that address. The read address of a register must be written to the address pointer before data can be read from that register.

### ALERT Output

Pin 8 can be configured as an  $\overline{\text{ALERT}}$  output. The  $\overline{\text{ALERT}}$  output goes low whenever an out-of-limit measurement is detected, or if the remote temperature sensor is an open circuit. It is an open-drain output and requires a pullup to  $V_{\text{DD}}$ . Several  $\overline{\text{ALERT}}$  outputs can be wire-OR'ed together, so that the common line goes low if one or more of the  $\overline{\text{ALERT}}$  outputs goes low.

The  $\overline{\text{ALERT}}$  output can be used as an interrupt signal to a processor, or it can be used as a  $\overline{\text{SMBALERT}}$ . Slave devices on the SMBus cannot normally signal to the bus master that they want to talk, but the  $\overline{\text{SMBALERT}}$  function allows them to do so.

One or more  $\overline{\text{ALERT}}$  outputs can be connected to a common  $\overline{\text{SMBALERT}}$  line connected to the master. When the  $\overline{\text{SMBALERT}}$  line is pulled low by one of the devices, the following procedure occurs as illustrated in Figure 19.

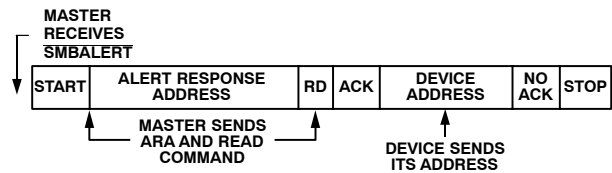

Figure 19. Use of  $\overline{\text{SMBALERT}}$

1.  $\overline{\text{SMBALERT}}$  is pulled low.
2. Master initiates a read operation and sends the alert response address (ARA = 0001 100). This is a general call address that should not be used as a specific device address.
3. The device whose  $\overline{\text{ALERT}}$  output is low responds to the alert response address and the master reads its device address. As the device address is seven bits, an LSB of 1 is added. The address of the device is now known and it can be interrogated in the usual way.
4. If more than one device has a low  $\overline{\text{ALERT}}$ , the one with the lowest device address has priority, in accordance with normal SMBus arbitration.
5. Once the ADT7482 has responded to the alert response address, it resets its  $\overline{\text{ALERT}}$  output, provided that the error condition that caused the  $\overline{\text{ALERT}}$  no longer exists. If the  $\overline{\text{SMBALERT}}$  line remains low, the master sends the ARA again, and so on until all devices with low  $\overline{\text{ALERT}}$  outputs respond.

### Low Power Standby Mode

The ADT7482 can be put into low power standby mode by setting Bit 6 (Mon/STBY bit) of the Configuration 1 register (Read Address = 0x03, Write Address = 0x09) to 1. When Bit 6 is 0, the ADT7482 operates normally. When Bit 6 is 1, the ADC is inhibited, and any conversion in progress is terminated without writing the result to the corresponding value register.

The SMBus is still enabled in low power standby mode. Power consumption in this standby mode is reduced to a typical of 5  $\mu\text{A}$  if there is no SMBus activity or up to 30  $\mu\text{A}$  if there are clock and data signals on the bus.

When the device is in standby mode, it is still possible to initiate a one-shot conversion of all channels by writing to the one-shot register (Address 0x0F), after which the device returns to standby. It does not matter what is written to the one-shot register as all data written to it is ignored. It is also possible to write new values to the limit register while in standby mode. If the values stored in the temperature value registers are now outside the new limits, an  $\overline{\text{ALERT}}$  is generated, even though the ADT7482 is still in standby mode.

### Sensor Fault Detection

The ADT7482 has sensor fault detection circuitry internally at its D+ inputs. This circuit can detect situations



where a remote diode is not connected, or is incorrectly connected, to the ADT7482. A simple voltage comparator trips if the voltage at D+ exceeds  $V_{DD} - 1\text{ V}$  (typical), signifying an open circuit between D+ and D-. The output of this comparator is checked when a conversion is initiated. Bit 2 (D1 OPEN flag) of the Status Register 1 (Address 0x02) is set if a fault is detected on the Remote 1 channel. Bit 2 (D2 OPEN flag) of the Status Register 2 (Address 0x23) is set if a fault is detected on the Remote 2 channel. If the  $\overline{\text{ALERT}}$  pin is enabled, setting this flag causes  $\overline{\text{ALERT}}$  to assert low.

If a remote sensor is not used with the ADT7482, then the D+ and D- inputs of the ADT7482 need to be tied together to prevent the OPEN flag from being set continuously.

Most temperature sensing diodes have an operating temperature range of  $-55^{\circ}\text{C}$  to  $+150^{\circ}\text{C}$ . Above  $150^{\circ}\text{C}$ , they lose their semiconductor characteristics and approximate conductors instead. This results in a diode short, setting the open flag. The remote diode in this case no longer gives an accurate temperature measurement. A read of the temperature result register gives the last good temperature measurement. Be aware that while the diode fault is triggered, the temperature measurement on the remote channels may not be accurate.

### Interrupt System

The ADT7482 has two interrupt outputs,  $\overline{\text{ALERT}}$  and  $\overline{\text{THERM}}$ . Both have different functions and behavior.  $\overline{\text{ALERT}}$  is maskable and responds to violations of software programmed temperature limits or an open-circuit fault on the remote diode.  $\overline{\text{THERM}}$  is intended as a fail-safe interrupt output that cannot be masked.

If the Remote 1, Remote 2, or local temperature exceeds the programmed high temperature limits, or equals or exceeds the low temperature limits, the  $\overline{\text{ALERT}}$  output is asserted low. An open-circuit fault on the remote diode also causes  $\overline{\text{ALERT}}$  to assert.  $\overline{\text{ALERT}}$  is reset when serviced by a master reading its device address, provided the error condition has gone away, and the status register has been reset.

The  $\overline{\text{THERM}}$  output asserts low if the Remote 1, Remote 2, or local temperature exceeds the programmed  $\overline{\text{THERM}}$  limits. The  $\overline{\text{THERM}}$  temperature limits should normally be equal to or greater than the high temperature limits.  $\overline{\text{THERM}}$  is reset automatically when the temperature falls back within the ( $\overline{\text{THERM}}$  - hysteresis) limit. The local and remote  $\overline{\text{THERM}}$  limits are set by default to  $85^{\circ}\text{C}$ . A hysteresis value can be programmed, in which case,  $\overline{\text{THERM}}$  resets when the temperature falls to the limit value minus the hysteresis value. This applies to both local and remote measurement channels. The power-on hysteresis default value is  $10^{\circ}\text{C}$ , but this can be reprogrammed to any value after powerup.

The hysteresis loop on the  $\overline{\text{THERM}}$  outputs is useful when  $\overline{\text{THERM}}$  is used for on/off control of a fan. The system can be set up so that when  $\overline{\text{THERM}}$  asserts, a fan can be switched on to cool the system. When  $\overline{\text{THERM}}$  goes high again, the

fan can be switched off. Programming a hysteresis value protects from fan jitter, where the temperature hovers around the  $\overline{\text{THERM}}$  limit, and the fan is constantly being switched on and off.

**Table 17.  $\overline{\text{THERM}}$  HYSTERESIS**

$\overline{\text{THERM}}$ Hysteresis	Binary Representation
$0^{\circ}\text{C}$	0 000 0000
$1^{\circ}\text{C}$	0 000 0001
$10^{\circ}\text{C}$	0 000 1010

If the ADT7482 is in the default temperature range ( $0^{\circ}\text{C}$  to  $127^{\circ}\text{C}$ ), then  $\overline{\text{THERM}}$  hysteresis must be less than the  $\overline{\text{THERM}}$  limit.

Figure 20 shows how the  $\overline{\text{THERM}}$  and  $\overline{\text{ALERT}}$  outputs operate. If desired, use the  $\overline{\text{ALERT}}$  output as a  $\overline{\text{SMBALERT}}$  to signal to the host via the SMBus that the temperature has risen. Use the  $\overline{\text{THERM}}$  output to turn on a fan to cool the system, if the temperature continues to increase. This method ensures that there is a fail-safe mechanism to cool the system, without the need for host intervention.

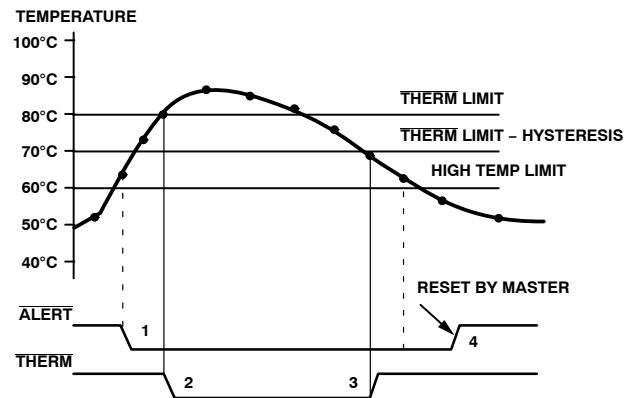

**Figure 20. Operation of the  $\overline{\text{ALERT}}$  and  $\overline{\text{THERM}}$  Interrupts**

1. If the measured temperature exceeds the high temperature limit, the  $\overline{\text{ALERT}}$  output asserts low.
2. If the temperature continues to increase and exceeds the  $\overline{\text{THERM}}$  limit, the  $\overline{\text{THERM}}$  output asserts low. This can be used to throttle the CPU clock or switch on a fan.
3. The  $\overline{\text{THERM}}$  output de-asserts (goes high) when the temperature falls to  $\overline{\text{THERM}}$  limit minus hysteresis. In Figure 20, the default hysteresis value of  $10^{\circ}\text{C}$  is shown.
4. The  $\overline{\text{ALERT}}$  output de-asserts only when the temperature has fallen below the high temperature limit, and the master has read the device address and cleared the status register.

Pin 8 on the ADT7482 can be configured as either an  $\overline{\text{ALERT}}$  output or as an additional  $\overline{\text{THERM}}$  output.  $\overline{\text{THERM2}}$  asserts low when the temperature exceeds the programmed local and/or remote high temperature limits. It is reset in the same manner as  $\overline{\text{THERM}}$ , and it is not

maskable. The programmed hysteresis value applies to  $\overline{\text{THERM2}}$  also.

Figure 21 shows how  $\overline{\text{THERM}}$  and  $\overline{\text{THERM2}}$  might operate together to implement two methods of cooling the system. In this example, the  $\overline{\text{THERM2}}$  limits are set lower than the  $\overline{\text{THERM}}$  limits. The  $\overline{\text{THERM2}}$  output could be used to turn on a fan. If the temperature continues to rise and exceeds the  $\overline{\text{THERM}}$  limits, the  $\overline{\text{THERM}}$  output could provide additional cooling by throttling the CPU.

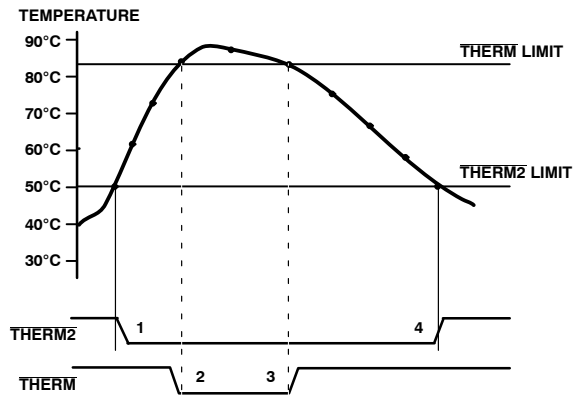

**Figure 21. Operation of the  $\overline{\text{THERM}}$  and  $\overline{\text{THERM2}}$  Interrupts**

1. When the  $\overline{\text{THERM2}}$  limit is exceeded, the  $\overline{\text{THERM2}}$  signal asserts low.
2. If the temperature continues to increase and exceeds the  $\overline{\text{THERM}}$  limit, the  $\overline{\text{THERM}}$  output asserts low.
3. The  $\overline{\text{THERM}}$  output de-asserts (goes high) when the temperature falls to  $\overline{\text{THERM}}$  limit minus hysteresis. In Figure 21, there is no hysteresis value shown.
4. As the system cools further, and the temperature falls below the  $\overline{\text{THERM2}}$  limit, the  $\overline{\text{THERM2}}$  signal resets. Again, no hysteresis value is shown for  $\overline{\text{THERM2}}$ .

The temperature measurement could be either the local or the remote temperature measurement.

## Applications Information

### Noise Filtering

For temperature sensors operating in noisy environments, the previous practice was to place a capacitor across the D+ pin and the D- pins to help combat the effects of noise. However, large capacitance's affect the accuracy of the temperature measurement, leading to a recommended maximum capacitor value of 1,000 pF. While this capacitor reduces the noise, it does not eliminate it, making it difficult to use the sensor in a very noisy environment.

The ADT7482 has a major advantage over other devices for eliminating the effects of noise on the external sensor. The series resistance cancellation feature allows a filter to be

constructed between the external temperature sensor and the part. The effect of any filter resistance seen in series with the remote sensor is automatically cancelled from the temperature result.

The construction of a filter allows the ADT7482 and the remote temperature sensor to operate in noisy environments. Figure 22 shows a low-pass R-C-R filter, with the following values:

$$R = 100 \, \Omega \text{ and } C = 1 \, \text{nF}$$

This filtering reduces both common-mode noise and differential noise.

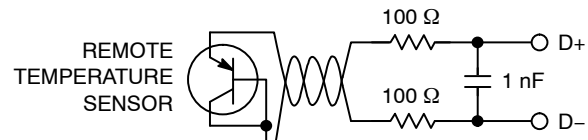

**Figure 22. Filter Between Remote Sensor and ADT7482**

## Factors Affecting Diode Accuracy

### Remote Sensing Diode

The ADT7482 is designed to work with substrate transistors built into processors or with discrete transistors. Substrate transistors are generally PNP types with the collector connected to the substrate. Discrete types can be either PNP or NPN transistors connected as a diode (base shorted to collector). If an NPN transistor is used, the collector and base are connected to D+ and the emitter to D-. If a PNP transistor is used, the collector and base are connected to D- and the emitter to D+.

To reduce the error due to variations in both substrate and discrete transistors, a number of factors should be taken into consideration:

- The ideality factor,  $n_f$ , of the transistor is a measure of the deviation of the thermal diode from ideal behavior. The ADT7482 is trimmed for an  $n_f$  value of 1.008. The following equation can be used to calculate the error introduced at a temperature T (°C), when using a transistor whose  $n_f$  does not equal 1.008. Consult the processor data sheet for the  $n_f$  values.

$$\Delta T = (n_f - 1.008)/1.008 \times (273.15 \text{ Kelvin} + T) \text{ (eq. 1)}$$

To factor this in, write the  $\Delta T$  value to the offset register. It is then automatically added to or subtracted from the temperature measurement by the ADT7482.

- Some CPU manufacturers specify the high and low current levels of the substrate transistors. The high current level of the ADT7482,  $I_{\text{HIGH}}$ , is 220  $\mu\text{A}$  and the low level current,  $I_{\text{LOW}}$ , is 13.5  $\mu\text{A}$ . If the ADT7482 current levels do not match the current levels specified by the CPU manufacturer, it may be necessary to remove an offset. The CPU data sheet advises whether this offset needs to be removed and how to calculate it.

This offset can be programmed to the offset register. It is important to note that if more than one offset must be considered, the algebraic sum of these offsets must be programmed to the offset register.

If a discrete transistor is being used with the ADT7482, the best accuracy is obtained by choosing devices according to the following criteria:

- Base-emitter voltage greater than 0.25 V at 6  $\mu$ A, at the highest operating temperature.
- Base-emitter voltage less than 0.95 V at 100  $\mu$ A, at the lowest operating temperature.
- Base resistance less than 100  $\Omega$ .
- Small variation in  $h_{FE}$  (such as 50 to 150) that indicates tight control of  $V_{BE}$  characteristics.

Transistors, such as 2N3904, 2N3906, or equivalents in SOT-23 packages, are suitable devices to use.

### Thermal Inertia and Self-heating

Accuracy depends on the temperature of the remote sensing diode and/or the local temperature sensor being at the same temperature as that being measured. A number of factors can affect this. Ideally, the sensor should be in good thermal contact with the part of the system being measured. If it is not, the thermal inertia caused by the sensor's mass causes a lag in the response of the sensor to a temperature change. In the case of the remote sensor, this should not be a problem, since it is either a substrate transistor in the processor or a small package device, such as SOT-23, placed in close proximity to it.

The on-chip sensor, however, is often remote from the processor and only monitors the general ambient temperature around the package. In practice, the ADT7482 package is in electrical, and hence thermal, contact with a PCB and may also be in a forced airflow. How accurately the temperature of the board and/or the forced airflow reflects the temperature to be measured also affects the accuracy. Self-heating due to the power dissipated in the ADT7482 or the remote sensor causes the chip temperature of the device or remote sensor to rise above ambient. However, the current forced through the remote sensor is so small that self-heating is negligible. In the case of the ADT7482, the worst-case condition occurs when the device is converting at 64 conversions per second while sinking the maximum current of 1 mA at the  $\overline{\text{ALERT}}$  and  $\overline{\text{THERM}}$  output. In this case, the total power dissipation in the device is about 4.5 mW. The thermal resistance,  $\theta_{JA}$ , of the MSOP-10 package is about 142°C/W.

### Layout Considerations

Digital boards can be electrically noisy environments, and the ADT7482 is measuring very small voltages from the remote sensor, so care must be taken to minimize noise induced at the sensor inputs. Take the following precautions:

1. Place the ADT7482 as close as possible to the remote sensing diode. Provided that the worst

noise sources, that is, clock generators, data/address buses, and CRTs, are avoided, this distance can be 4 inches to 8 inches.

2. Route the D+ and D- tracks close together, in parallel, with grounded guard tracks on each side. To minimize inductance and reduce noise pickup, a 5 mil track width and spacing is recommended. Provide a ground plane under the tracks, if possible.

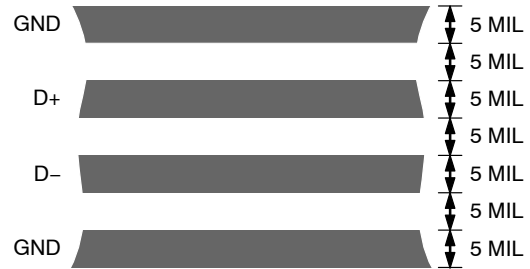

Figure 23. Typical Arrangement of Signal Tracks

3. Try to minimize the number of copper/solder joints that can cause thermocouple effects. Where copper/solder joints are used, make sure that they are in both the D+ and D- path and at the same temperature. Thermocouple effects should not be a major problem as 1°C corresponds to about 200 mV, and thermocouple voltages are about 3 mV/°C of temperature difference. Unless there are two thermocouples with a big temperature differential between them, thermocouple voltages should be much less than 200 mV.
4. Place a 0.1  $\mu$ F bypass capacitor close to the  $V_{DD}$  pin. In extremely noisy environments, an input filter capacitor can be placed across D+ and D-, close to the ADT7482. This capacitance can effect the temperature measurement, so care must be taken to ensure that any capacitance seen at D+ and D- is a maximum of 1000 pF. This maximum value includes the filter capacitance, plus any cable or stray capacitance between the pins and the sensor diode.
5. If the distance to the remote sensor is more than 8 inches, the use of twisted pair cable is recommended. A total of 6 feet to 12 feet is needed. For long distances (up to 100 feet), use shielded twisted pair, such as Belden No. 8451 microphone cable. Connect the twisted pair to D+ and D- and the shield to GND close to the ADT7482. Leave the remote end of the shield unconnected to avoid ground loops.

Because the measurement technique uses switched current sources, excessive cable or filter capacitance can affect the measurement. When using long cables, the filter capacitance can be reduced or removed.

# ADT7482

## Application Circuit

Figure 24 shows a typical application circuit for the ADT7482, using discrete sensor transistors. The pullups on SCLK, SDATA, and  $\overline{\text{ALERT}}$  are required only if they are not already provided elsewhere in the system.

The SCLK pin and the SDATA pin of the ADT7482 can be interfaced directly to the SMBus of an I/O controller, such as the Intel® 820 chipset.

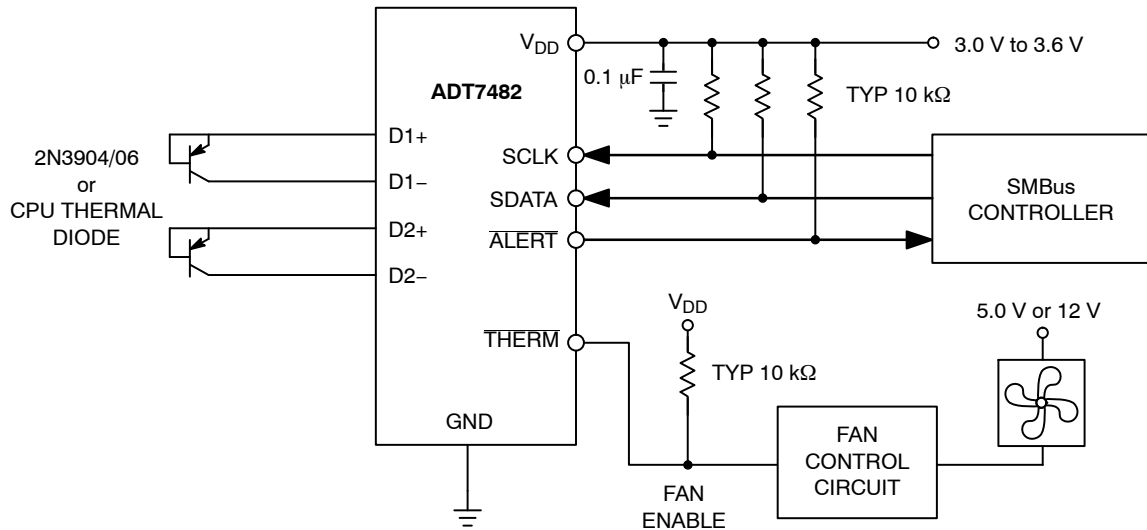

Figure 24. Typical Application Circuit

Table 18. ORDERING INFORMATION

Device Order Number*	Temperature Range	Package Type	Shipping†	SMBus Address
ADT7482ARMZ-REEL	-40°C to +125°C	10-lead MSOP	3,000 Tape & Reel	4C

†For information on tape and reel specifications, including part orientation and tape sizes, please refer to our Tape and Reel Packaging Specifications Brochure, BRD8011/D.

\*The "Z" suffix indicates Pb-Free package available.

# ADT7482

## PACKAGE DIMENSIONS

### MSOP10 CASE 846AC-01 ISSUE O

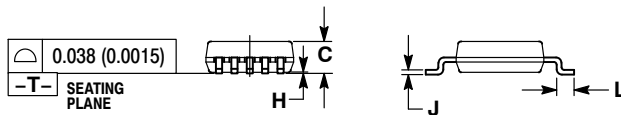
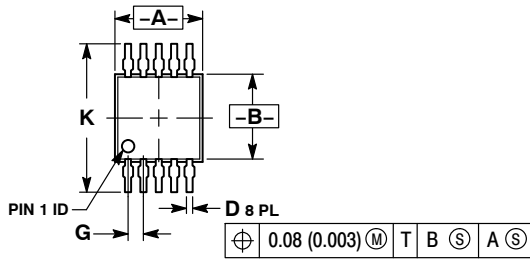

**NOTES:**

1. DIMENSIONING AND TOLERANCING PER ANSI Y14.5M, 1982.
2. CONTROLLING DIMENSION: MILLIMETER.
3. DIMENSION "A" DOES NOT INCLUDE MOLD FLASH, PROTRUSIONS OR GATE BURRS. MOLD FLASH, PROTRUSIONS OR GATE BURRS SHALL NOT EXCEED 0.15 (0.006) PER SIDE.
4. DIMENSION "B" DOES NOT INCLUDE INTERLEAD FLASH OR PROTRUSION. INTERLEAD FLASH OR PROTRUSION SHALL NOT EXCEED 0.25 (0.010) PER SIDE.
5. 846B-01 OBSOLETE. NEW STANDARD 846B-02

DIM	MILLIMETERS		INCHES	
	MIN	MAX	MIN	MAX
A	2.90	3.10	0.114	0.122
B	2.90	3.10	0.114	0.122
C	0.95	1.10	0.037	0.043
D	0.20	0.30	0.008	0.012
G	0.50 BSC		0.020 BSC	
H	0.05	0.15	0.002	0.006
J	0.10	0.21	0.004	0.008
K	4.75	5.05	0.187	0.199
L	0.40	0.70	0.016	0.028

### SOLDERING FOOTPRINT\*

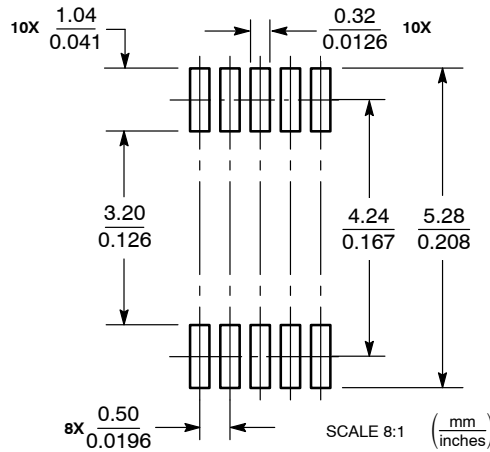

\*For additional information on our Pb-Free strategy and soldering details, please download the ON Semiconductor Soldering and Mounting Techniques Reference Manual, SOLDERRM/D.

ON Semiconductor and are registered trademarks of Semiconductor Components Industries, LLC (SCILLC). SCILLC owns the rights to a number of patents, trademarks, copyrights, trade secrets, and other intellectual property. A listing of SCILLC's product/patent coverage may be accessed at [www.onsemi.com/site/pdf/Patent-Marking.pdf](http://www.onsemi.com/site/pdf/Patent-Marking.pdf). SCILLC reserves the right to make changes without further notice to any products herein. SCILLC makes no warranty, representation or guarantee regarding the suitability of its products for any particular purpose, nor does SCILLC assume any liability arising out of the application or use of any product or circuit, and specifically disclaims any and all liability, including without limitation special, consequential or incidental damages. "Typical" parameters which may be provided in SCILLC data sheets and/or specifications can and do vary in different applications and actual performance may vary over time. All operating parameters, including "Typicals" must be validated for each customer application by customer's technical experts. SCILLC does not convey any license under its patent rights nor the rights of others. SCILLC products are not designed, intended, or authorized for use as components in systems intended for surgical implant into the body, or other applications intended to support or sustain life, or for any other application in which the failure of the SCILLC product could create a situation where personal injury or death may occur. Should Buyer purchase or use SCILLC products for any such unintended or unauthorized application, Buyer shall indemnify and hold SCILLC and its officers, employees, subsidiaries, affiliates, and distributors harmless against all claims, costs, damages, and expenses, and reasonable attorney fees arising out of, directly or indirectly, any claim of personal injury or death associated with such unintended or unauthorized use, even if such claim alleges that SCILLC was negligent regarding the design or manufacture of the part. SCILLC is an Equal Opportunity/Affirmative Action Employer. This literature is subject to all applicable copyright laws and is not for resale in any manner.

### PUBLICATION ORDERING INFORMATION

**LITERATURE FULFILLMENT:**  
Literature Distribution Center for ON Semiconductor  
P.O. Box 5163, Denver, Colorado 80217 USA  
**Phone:** 303-675-2175 or 800-344-3860 Toll Free USA/Canada  
**Fax:** 303-675-2176 or 800-344-3867 Toll Free USA/Canada  
**Email:** [orderlit@onsemi.com](mailto:orderlit@onsemi.com)

**N. American Technical Support:** 800-282-9855 Toll Free  
USA/Canada  
**Europe, Middle East and Africa Technical Support:**  
Phone: 421 33 790 2910  
**Japan Customer Focus Center**  
Phone: 81-3-5817-1050

**ON Semiconductor Website:** [www.onsemi.com](http://www.onsemi.com)  
**Order Literature:** <http://www.onsemi.com/orderlit>  
For additional information, please contact your local Sales Representative