

25 WATT FLANGE MOUNT GAN MMIC POWER AMPLIFIER, 2 - 6 GHz

Typical Applications

The HMC1086F10 is ideal for:

- Test Instrumentation
- General Communications
- Radar
- EW/ECM

Features

- High Psat: +44.5 dBm
- Power Gain at Psat: 11 dB
- High Output IP3: +46 dBm
- Small Signal Gain: 23 dB
- Supply Voltage: Vdd = +28V @ 1100 mA
- 50 Ohm Matched Input/Output
- 10-Lead Flange Mount Package

Functional Diagram

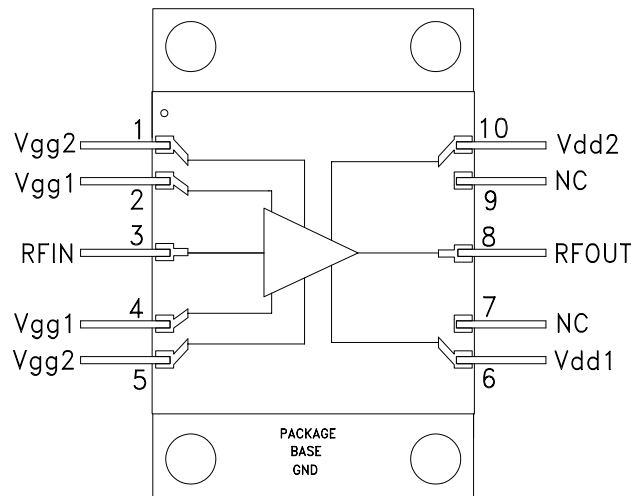

General Description

The HMC1086F10 is a 25W Gallium Nitride (GaN) MMIC Power Amplifier which operates between 2 and 6 GHz, and is provided in a 10-lead flange mount package. The amplifier typically provides 23 dB of small signal gain, +44.5 dBm saturated output power, and delivers +46 dBm output IP3 at +33 dBm output power per tone. The amplifier draws 1100 mA quiescent current from a +28V DC supply. The RF I/Os are DC blocked and matched to 50 Ohms for ease of use.

Electrical Specifications, $T_A = +25^\circ\text{C}$, $V_{gg} = V_{gg1} = V_{gg2}$, $V_{dd} = V_{dd1} = V_{dd2} = +28\text{V}$, $I_{dd} = 1100\text{ mA}$ [1]

Parameter	Min.	Typ.	Max.	Min.	Typ.	Max.	Units
Frequency Range	2 - 4		4 - 6				GHz
Small Signal Gain	20	23		21	24		dB
Gain Flatness		± 1			± 0.5		dB
Gain Variation Over Temperature		0.03			0.03		dB/ $^\circ\text{C}$
Input Return Loss		15			17		dB
Output Return Loss		12			12		dB
Output Power for 4dB Compression (P4dB)		41			41		dBm
Power Gain for 4dB Compression (P4dB)		20			20		dB
Saturated Output Power (Psat)		44.5			44.5		dBm
Output Third Order Intercept (IP3) [2]		46			46		dBm
Power Added Efficiency (PAE)		35			32		%
Total Supply Current (Id1 + Id2)		1100			1100		mA

[1] Adjust Vgg between -8 to 0V to achieve Idd = 1100 mA typical.

[2] Measurement taken at Pout / tone = +33 dBm.

**25 WATT FLANGE MOUNT GAN MMIC
POWER AMPLIFIER, 2 - 6 GHz**

Gain & Return Loss

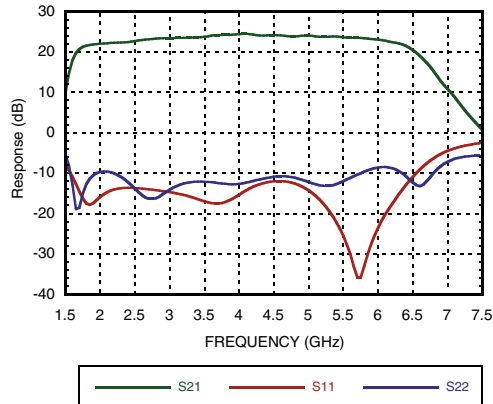

Gain vs. Temperature

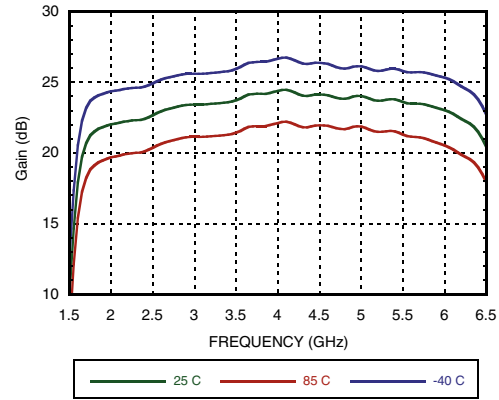

Gain vs. Vdd

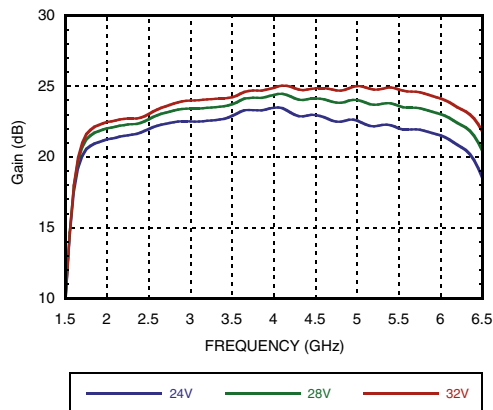

Input Return Loss vs. Temperature

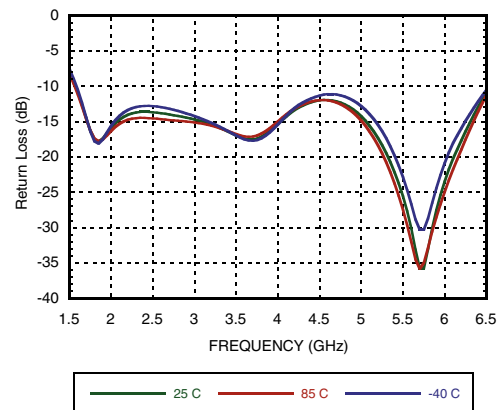

Output Return Loss vs. Temperature

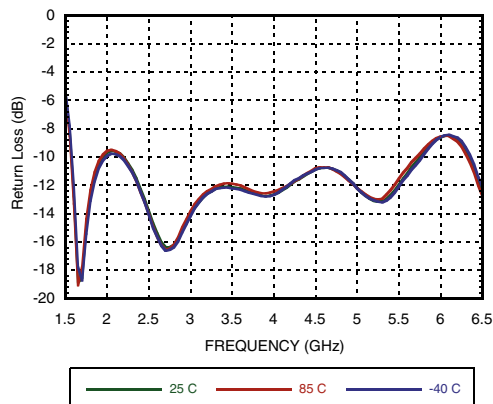

Pout vs. Frequency

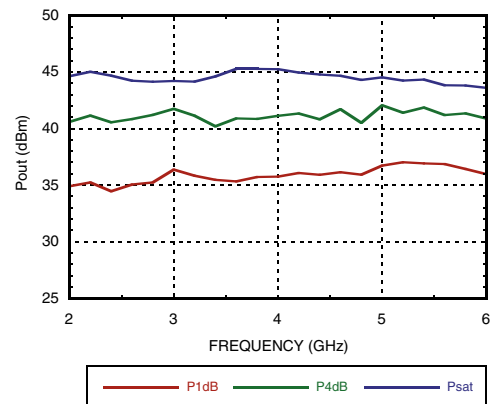

**25 WATT FLANGE MOUNT GAN MMIC
POWER AMPLIFIER, 2 - 6 GHz**

P4dB vs. Temperature

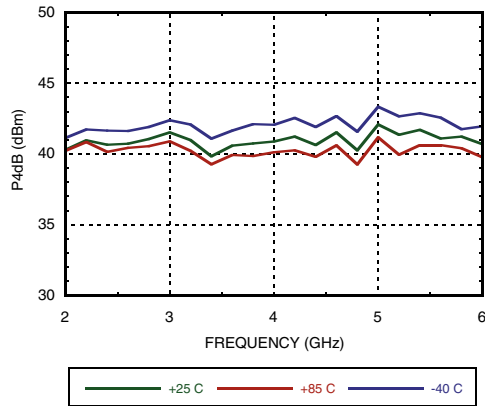

P4dB vs. Supply Voltage

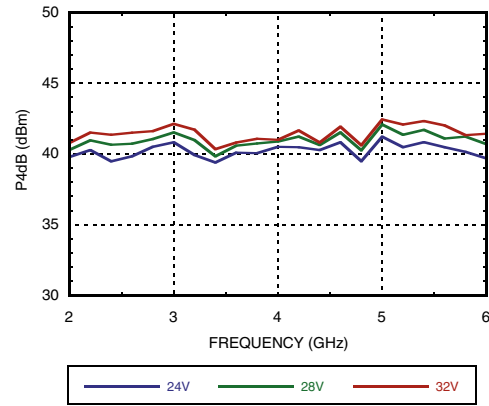

Psat vs. Temperature

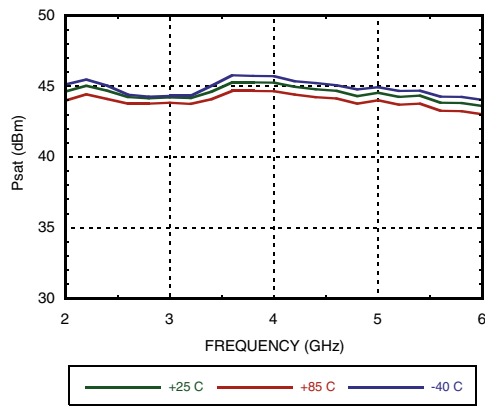

Psat vs. Supply Voltage

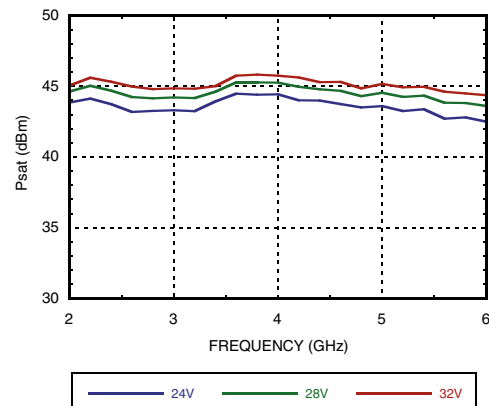

P4dB vs. Supply Current

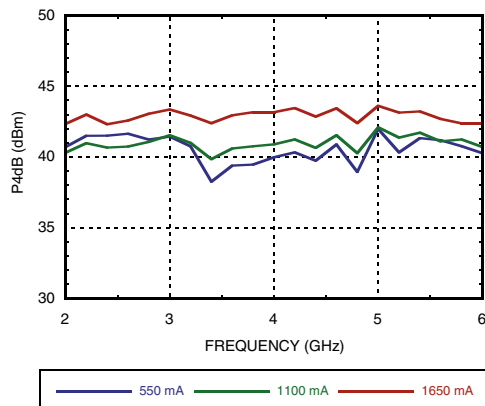

Psat vs. Supply Current

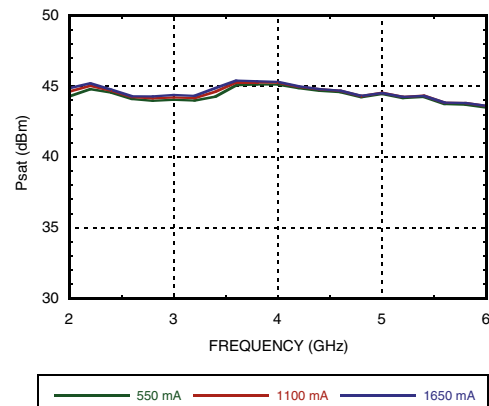

**25 WATT FLANGE MOUNT GAN MMIC
POWER AMPLIFIER, 2 - 6 GHz**

Power Gain vs. Frequency

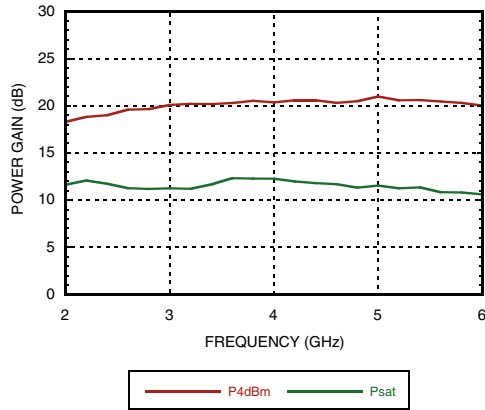

**Output IP3 vs. Temperature,
Pout/tone = +33 dBm**

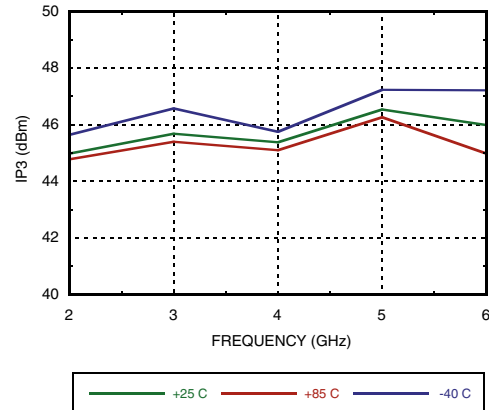

**Output IP3 vs. Supply Voltage,
Pout/tone = +33 dBm**

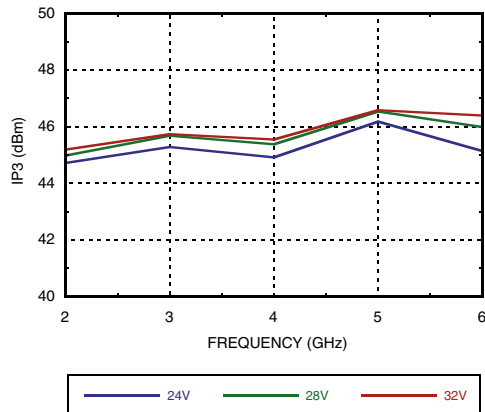

**Output IP3 vs. Supply Current,
Pout/tone = +33 dBm**

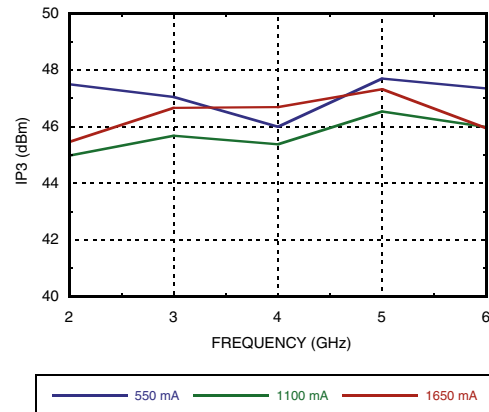

Output IM3 @ Vdd= +24V

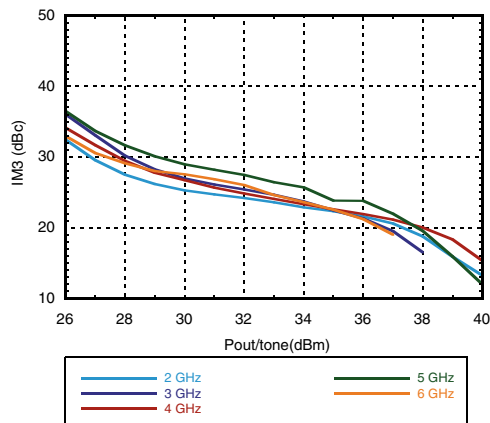

Output IM3 @ Vdd= +28V

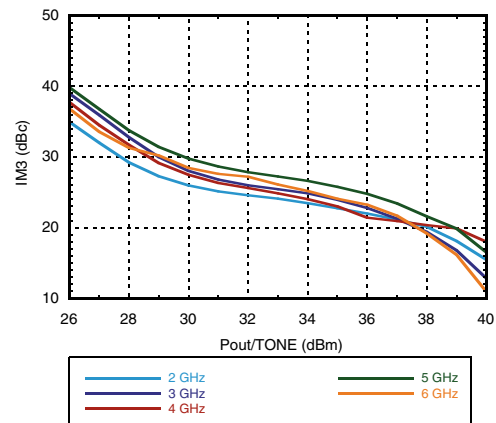

**25 WATT FLANGE MOUNT GAN MMIC
POWER AMPLIFIER, 2 - 6 GHz**

Output IM3 @ Vdd= +32V

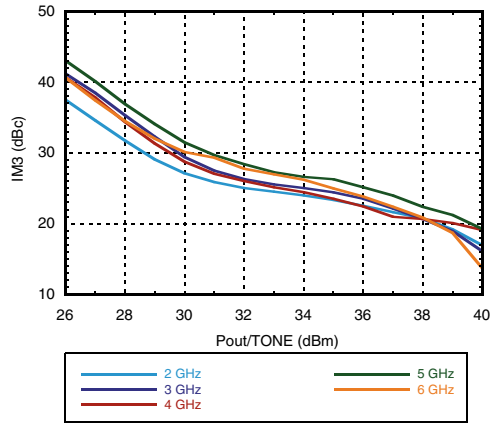

Power Compression @ 2 GHz

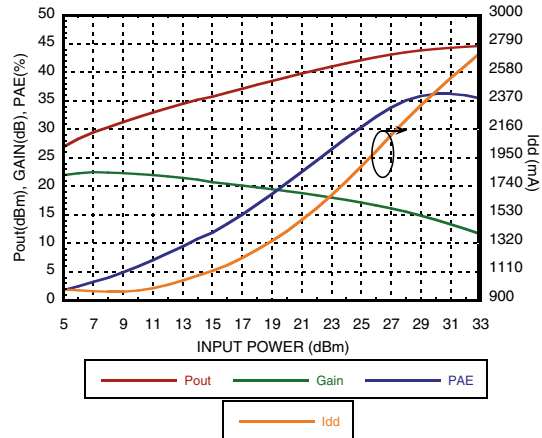

Power Compression @ 4 GHz

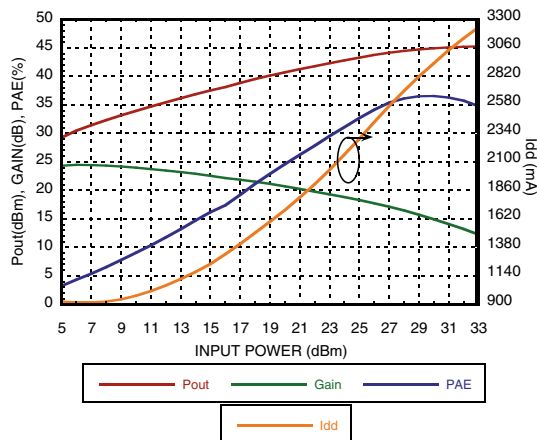

Power Compression @ 6 GHz

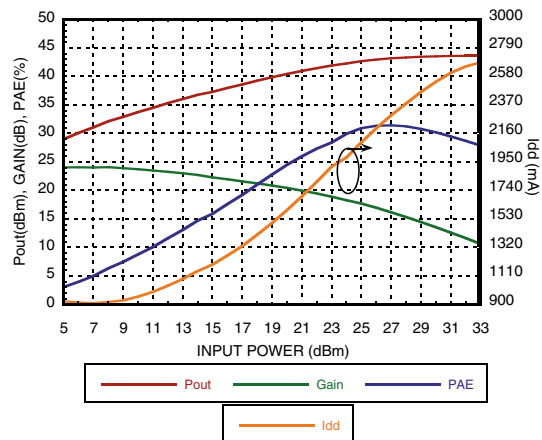

Gain & Power vs. Supply Voltage @ 4 GHz

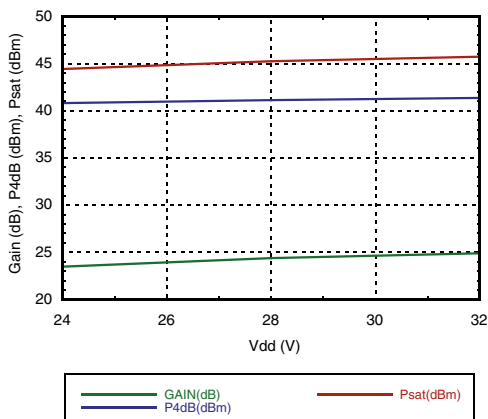

Gain & Power vs. Supply Current @ 4 GHz

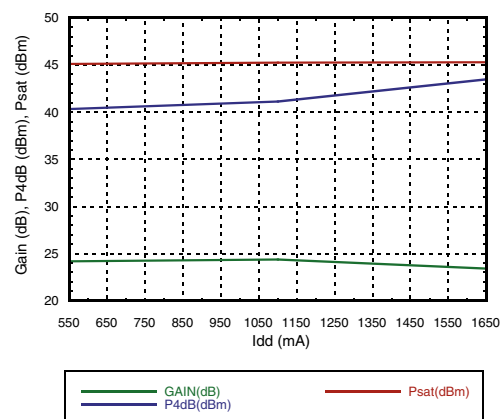

**25 WATT FLANGE MOUNT GAN MMIC
POWER AMPLIFIER, 2 - 6 GHz**

Reverse Isolation vs. Temperature

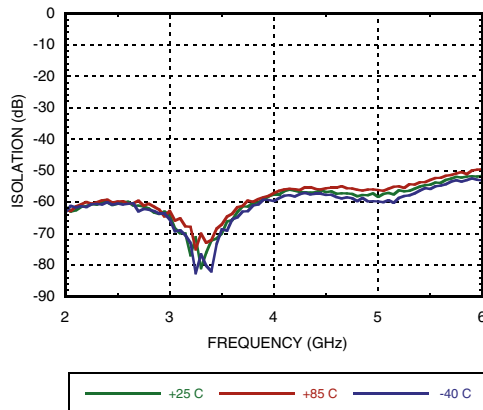

Second Harmonics vs. Temperature

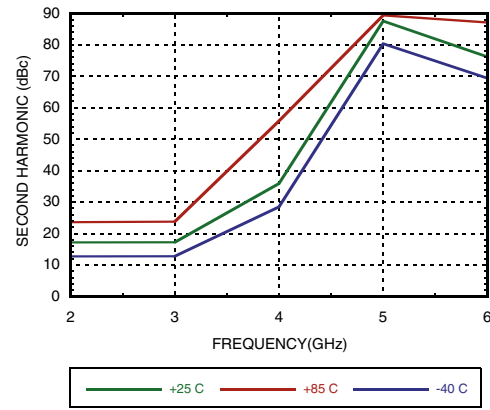

Second Harmonics vs. Supply Voltage

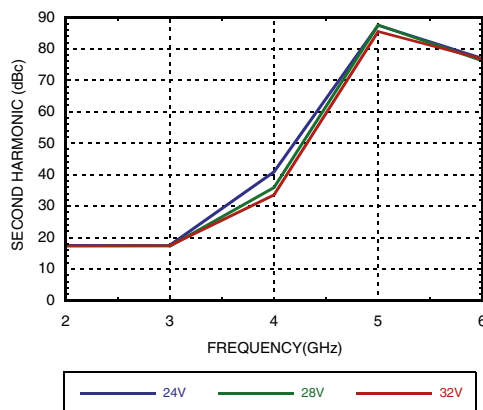

Second Harmonics vs. Pin

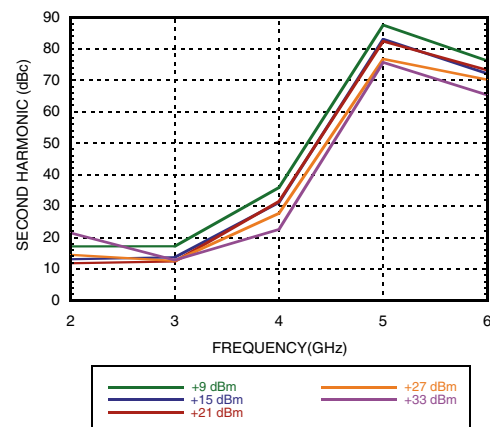

Power Dissipation

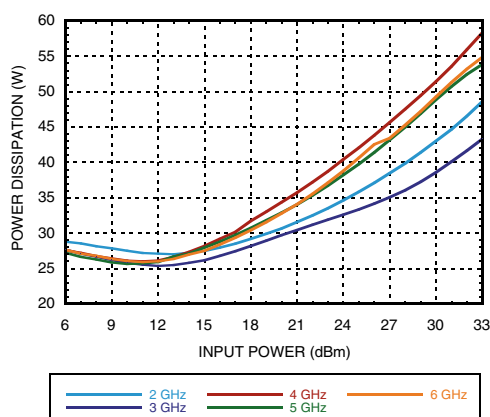

**Additive Phase Noise Vs Offset Frequency,
RF Frequency = 4 GHz,
RF Input Power = 27 dBm (P1dB)**

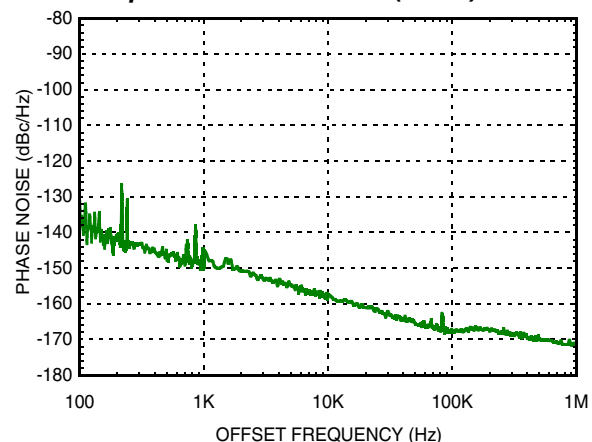

25 WATT FLANGE MOUNT GAN MMIC POWER AMPLIFIER, 2 - 6 GHz

Absolute Maximum Ratings

Drain Bias Voltage (Vdd)	+32 Vdc
Gate Bias Voltage (Vgg)	-8 to 0 Vdc
RF Input Power (RFIN)	+33 dBm
Channel Temperature	225 °C
Maximum P _{diss} (T = 85 °C) (derate 432 mW/°C above 85 °C)	60.5W
Thermal Resistance (channel to flange bottom)	2.31 °C/W
Maximum Forward Gate Current (mA)	11 mA
Maximum VSWR ^[1]	6:1
Storage Temperature	-65 to 150 °C ^[2]
Operating Temperature	-40 to 85 °C

[1] Restricted by maximum power dissipation.

[2] This device is not surface mountable and is not intended nor suitable to be used in a solder reflow process.
This device must not be exposed to ambient temperatures above +150°C.

Typical Supply Current vs. Vdd

Vdd (V)	I _{dd} (mA)
+24	1100
+28	1100
+32	1100

Adjust V_{gg} to achieve I_{dd} = 1100 mA

Amplifier Turn-on Procedure:

- 1.) Set V_{gg} to -5V.
- 2.) Set V_{dd} to +28V.
- 3.) Ramp gate voltage until quiescent drain current = 1100 mA.
- 4.) Apply RF input power.

Amplifier Turn-off Procedure:

- 1.) Remove RF input power.
- 2.) Set V_{gg} to -5V.
- 3.) Set V_{dd} to 0V.
- 4.) Set V_{gg} to 0V.



ELECTROSTATIC SENSITIVE DEVICE
OBSERVE HANDLING PRECAUTIONS

25 WATT FLANGE MOUNT GAN MMIC POWER AMPLIFIER, 2 - 6 GHz

Outline Drawing

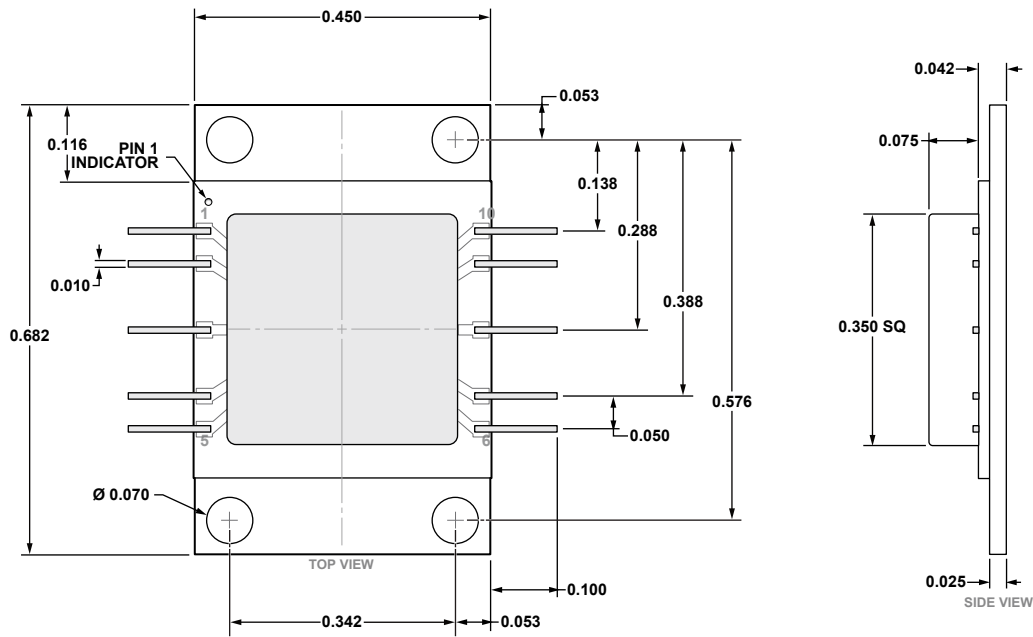

10-Lead Ceramic Leaded Chip Carrier [LDCC]
(EJ-10-1)
Dimensions shown in inches

Package Information



Part Number	Package Body Material	Lead Finish	MSL Rating	Package Marking ^[1]
HMC1086F10	Copper 15 Tungston 85	NiAu	N/A ^[2]	H1086 XXXX

[1] 4-Digit lot number XXXX

[2] This device is not rated for Moisture Sensitivity Level. The HMC1086F10 is a non-hermetic, air cavity device which is not surface mountable and is not intended nor suitable to be used in a solder reflow process.

25 WATT FLANGE MOUNT GAN MMIC POWER AMPLIFIER, 2 - 6 GHz

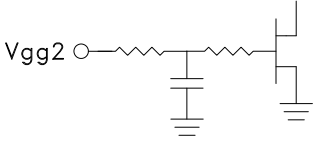
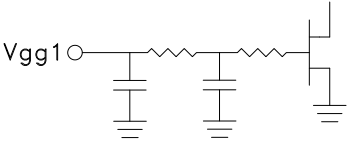
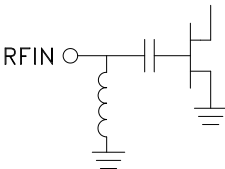
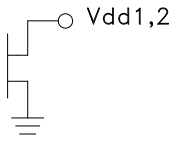
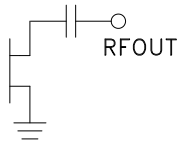
Pin Descriptions

Pin Number	Function	Description	Interface Schematic
1, 5	Vgg2	Gate control voltage for second stage.	
2, 4	Vgg1	Gate control voltage for first stage.	
3	RFIN	This pin is DC coupled and matched to 50 Ohms.	
6, 10	Vdd1,2	Drain bias for first and second stage	
7, 9	NC	These pins are not connected internally.	
8	RFOUT	This pad is RF coupled and matched to 50 Ohms.	
Package Base	GND	The package base must be mounted to a suitable heat sink for RF & DC ground. Recommended mounting screws are #0-80 socket cap screws.	

**25 WATT FLANGE MOUNT GAN MMIC
POWER AMPLIFIER, 2 - 6 GHz**

Application Circuit

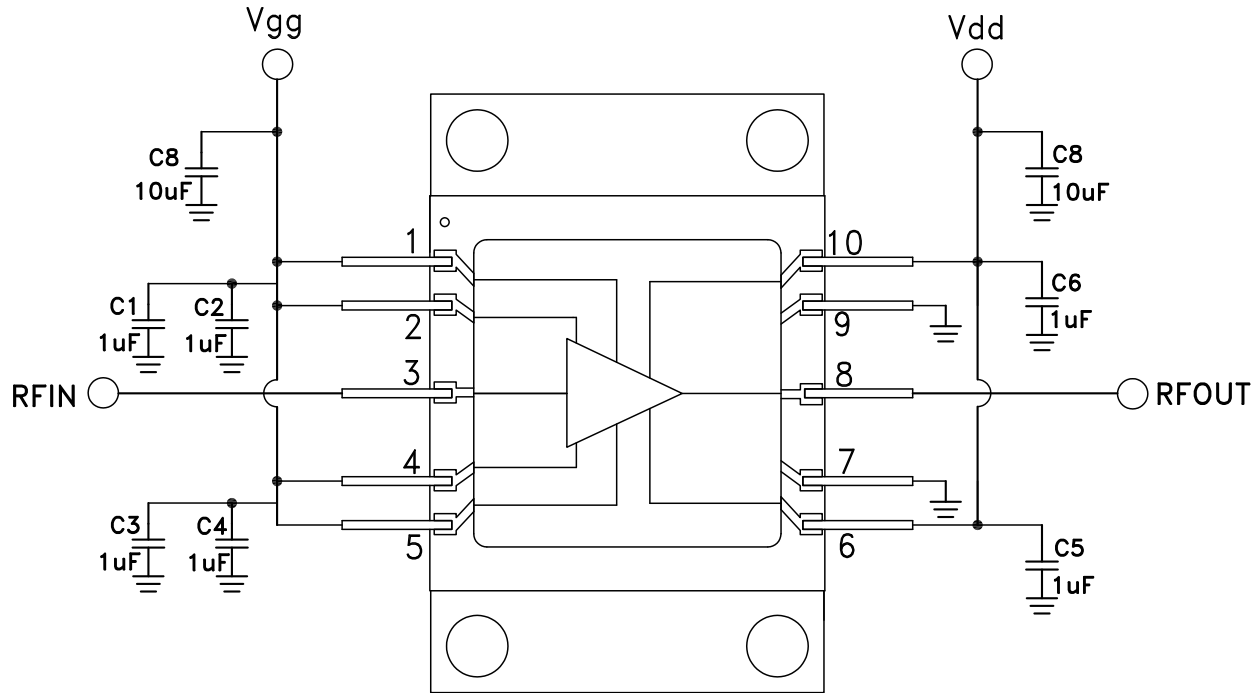

**25 WATT FLANGE MOUNT GAN MMIC
POWER AMPLIFIER, 2 - 6 GHz**

Evaluation PCB

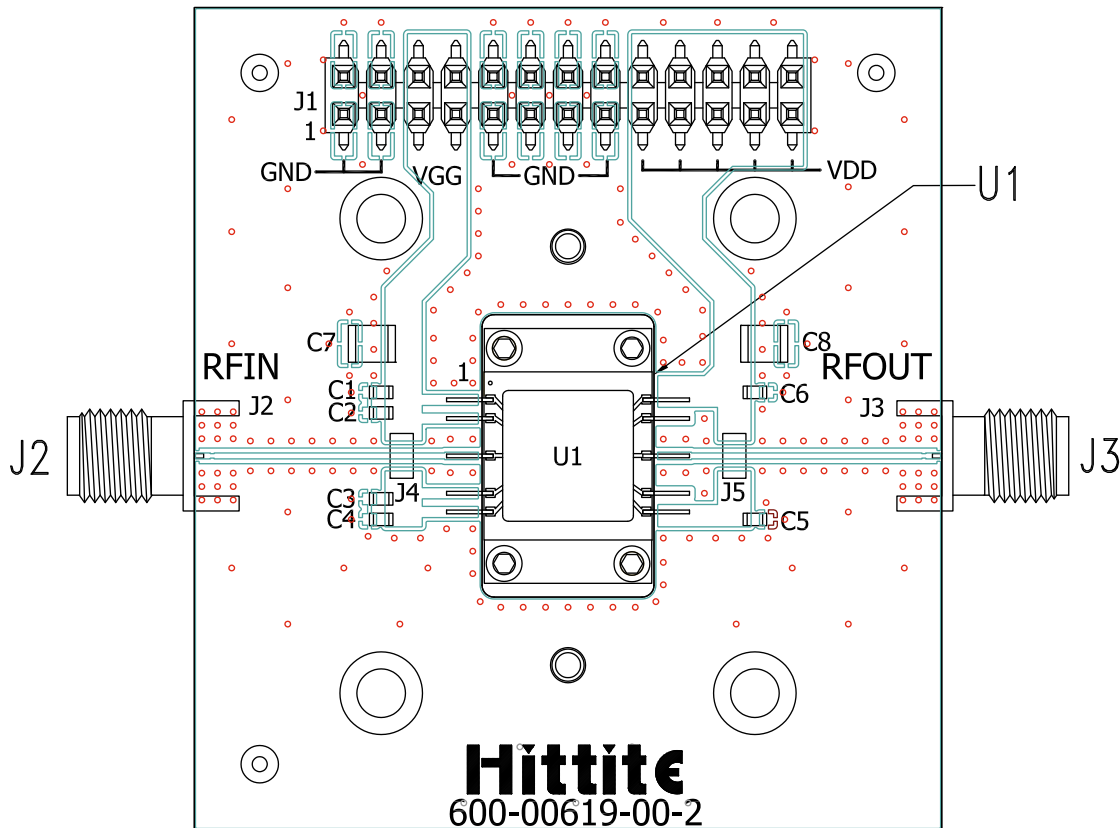

Evaluation Order Information

Item	Contents	Part Number
Evaluation PCB	HMC1086F10 Evaluation PCB	EVAL01-HMC1086F10 [1]

[1] Reference this number when ordering Evaluation PCB

List of Materials for Evaluation PCB EVAL01-HMC1086F10

Item	Description
J2, J3	SRI K Connector
J1	DC Connector
J4, J5	Preform jumpers
C1 - C6	1 uF Capacitor, 0602 Pkg.
C7 - C8	10 uF Capacitor, 1210 Pkg.
U1	HMC1086F10
PCB [1]	600-00619-00 Evaluation PCB

[1] Circuit Board Material: Rogers 4350 or Arlon 25FR

The circuit board used in the application should use RF circuit design techniques. Signal lines should have 50 Ohm impedance while the package ground leads and exposed paddle should be connected directly to the ground plane similar to that shown. A sufficient number of via holes should be used to connect the top and bottom ground planes. The evaluation circuit board shown is available from Analog Devices, upon request.

**25 WATT FLANGE MOUNT GAN MMIC
POWER AMPLIFIER, 2 - 6 GHz**

Notes: