

# 2SC5100

Silicon NPN Triple Diffused Planar Transistor (Complement to type 2SA1908)

Application : Audio and General Purpose

### Absolute maximum ratings (Ta=25°C)

Symbol	Ratings	Unit
V <sub>CB0</sub>	160	V
V <sub>CE0</sub>	120	V
V <sub>EB0</sub>	6	V
I <sub>C</sub>	8	A
I <sub>B</sub>	3	A
P <sub>C</sub>	75(T <sub>C</sub> =25°C)	W
T <sub>J</sub>	150	°C
T <sub>stg</sub>	-55 to +150	°C

### Electrical Characteristics (Ta=25°C)

Symbol	Conditions	Ratings	Unit
I <sub>CB0</sub>	V <sub>CB</sub> =160V	10max	μA
I <sub>EB0</sub>	V <sub>EB</sub> =6V	10max	μA
V <sub>(BR)CEO</sub>	I <sub>C</sub> =50mA	120min	V
h <sub>FE</sub>	V <sub>CE</sub> =4V, I <sub>C</sub> =3A	50min*	
V <sub>CE(sat)</sub>	I <sub>C</sub> =3A, I <sub>B</sub> =0.3A	0.5max	V
f <sub>T</sub>	V <sub>CE</sub> =12V, I <sub>E</sub> =-0.5A	20typ	MHz
COB	V <sub>CB</sub> =10V, f=1MHz	200typ	pF

\*h<sub>FE</sub> Rank ○(50to100), P(70to140), Y(90to180)

### Typical Switching Characteristics (Common Emitter)

V <sub>CC</sub> (V)	R <sub>L</sub> (Ω)	I <sub>C</sub> (A)	V <sub>BB1</sub> (V)	V <sub>BB2</sub> (V)	I <sub>B1</sub> (A)	I <sub>B2</sub> (A)	t <sub>on</sub> (μs)	t <sub>stg</sub> (μs)	t <sub>f</sub> (μs)
40	10	4	10	-5	0.4	-0.4	0.13typ	3.50typ	0.32typ

### External Dimensions FM100(TO3PF)

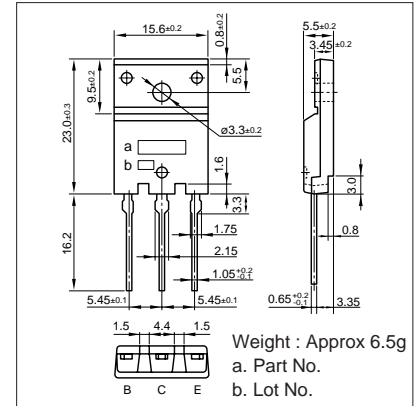

I<sub>C</sub>-V<sub>CE</sub> Characteristics (Typical)

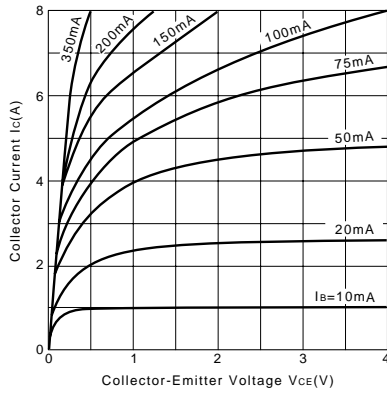

V<sub>CE(sat)</sub>-I<sub>B</sub> Characteristics (Typical)

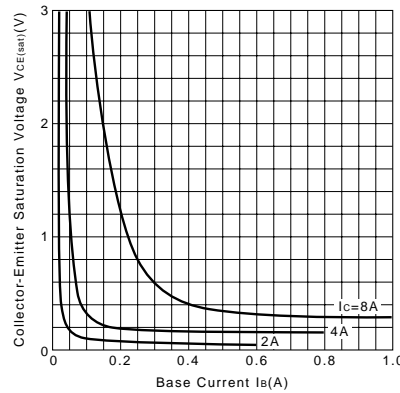

I<sub>C</sub>-V<sub>BE</sub> Temperature Characteristics (Typical)

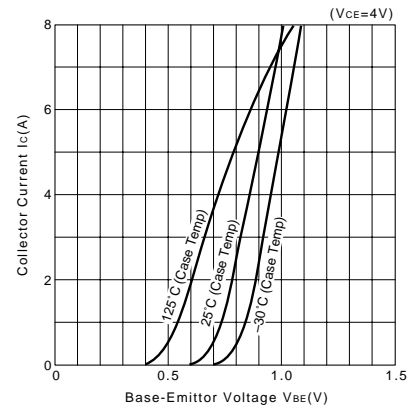

h<sub>FE</sub>-I<sub>C</sub> Characteristics (Typical)

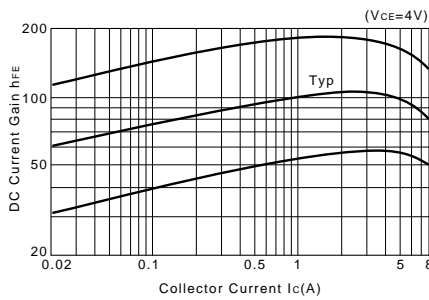

h<sub>FE</sub>-I<sub>C</sub> Temperature Characteristics (Typical)

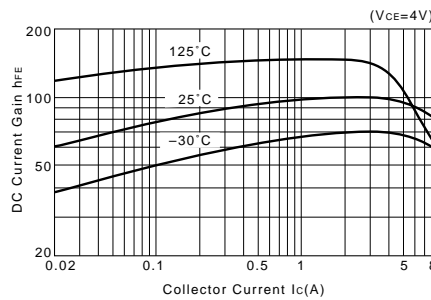

θ<sub>j-a</sub>-t Characteristics

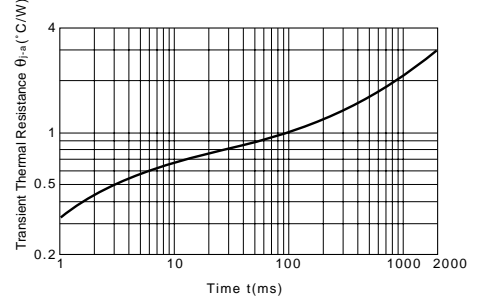

f<sub>T</sub>-I<sub>E</sub> Characteristics (Typical)

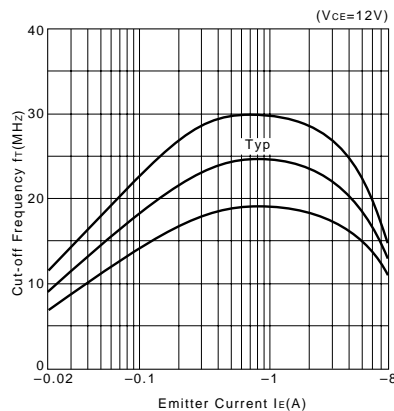

Safe Operating Area (Single Pulse)

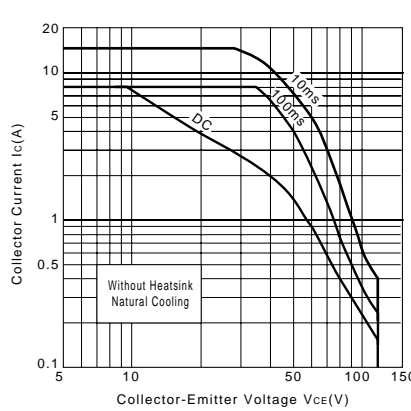

P<sub>C</sub>-T<sub>a</sub> Derating

