

Pro Editor Software

Instruction Manual

Original Instructions
206058 Rev. I
25 March 2021
© Banner Engineering Corp. All rights reserved



206058

Contents

1 Software Description	4
1.1 Overview	4
2 Specifications and Requirements	5
2.1 Pro Editor Software PC Requirements	5
2.2 Pro Converter Cable – Required for use with Pro Editor	5
2.2.1 Model	5
2.2.2 Features	6
2.3 Pro Converter Cable Specifications	6
2.4 Banner Engineering Corp. Software Copyright Notice	6
3 Installation Instructions	7
3.1 Install the Software	7
3.1.1 Update the Software	7
3.2 Install the Pro Converter Cable Driver (Windows 7)	7
3.3 Connect the Cables	7
3.3.1 Full Preview Connection (Recommended)	8
3.3.2 Limited Preview Connection	8
3.4 Connect a Device	8
4 Navigating Pro Editor	10
4.1 Menu Bar	11
4.2 Indicator Devices	11
4.2.1 I/O State – Basic	11
4.2.2 I/O State – Advanced	12
4.2.3 I/O State – I/O Block	12
4.3 Touch Devices	12
4.3.1 Device Logic Mode – Four State Full Logic	12
4.3.2 Device Logic Mode – Three State Advanced Control	13
4.3.3 Device Logic Mode – Seven State Advanced Control	14
4.3.4 Global Parameters and Advanced Settings	14
4.4 Tower Light Devices	15
4.4.1 Tower Light Segment Mode	15
4.4.2 Tower Light Run Mode	17
4.4.3 Tower Light Advanced Mode	18
4.4.4 Global Parameters and Advanced Settings	20
4.5 Strip Light Devices	20
4.5.1 Application: Machine and Work Cell	21
4.5.2 Application: Tower Light	23
4.5.3 Application: Timer	24
4.5.4 Application: Counter	25
4.5.5 Application: Distance	27
4.5.6 Application: Gauge	29
4.5.7 Application: Mobile	30
4.5.8 Application: Pick Put Build	31
4.6 Read Device Settings	33
4.7 Write Device Settings	33
4.8 Connected Device Information	33
4.9 Device Connection Status and Software Update Notification	33
5 Configure a Device	34
5.1 Preview	34
5.2 Tower Light Advanced Mode Preview	34
5.3 Device State	35
5.4 Animation	35
5.5 Color 1 or Color 2	37
5.6 Intensity 1 or Intensity 2	37
5.7 Speed	38
5.8 Pattern	38
5.9 Direction	38
5.10 Shift Enable	38
5.11 Audible	38
5.12 Vibration	39
6 Troubleshooting	40
6.1 Pro Editor Error Messages	40
6.2 Pro Converter Cable Error	40
7 Accessories	41

7.1 Pro Editor Hardware	41
8 Product Support and Maintenance	42
8.1 Maintenance	42
8.1.1 Update the Software	42
8.2 Pro Editor Release Notes	42
8.3 Contact Us	42
8.4 Banner Engineering Corp. Limited Warranty	43
8.5 FCC Part 15 and CAN ICES-3 (B)/NMB-3(B)	43

1 Software Description

Software that Enables Field Configuration of Banner Pro Series-enabled Devices

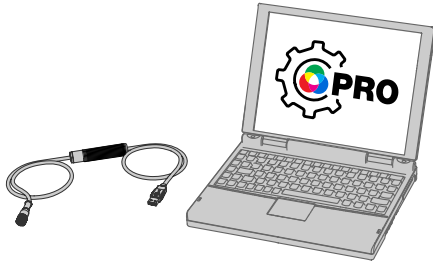

- Allows configuration of Banner Pro Series-enabled lighting and indicator devices
- Free to download and available from the product page of any Pro Series-enabled device or at www.bannerengineering.com/proeditor
- Works on Microsoft® Windows® 7 and 10¹
- Pro Converter Cable MQDC-506-USB required to connect PC-based Pro Editor software to Pro Series-enabled lighting and indicator devices
- Full preview capabilities are available with the use of power supply PSW-24-1 or PSD-24-4 and splitter CSB-M1251FM1251M. The power supply and splitter are required for connection to TL50 Pro, WLS15 Pro, K90 Pro, and WLS27 Pro models.



Note: Administrative rights are required to install the Pro Editor software.

1.1 Overview

Banner's Pro Editor software offers an easy way to configure Pro Series-enabled indication, touch, and illumination devices, allowing users full control of device states and device logic modes. The easy-to-use configuration software provides a variety of tools and capabilities to solve a wide range of applications such as indicating machine status or warm-up time, indicating unique steps in an assembly process, or incorporating status information into touch buttons.

Select Pro Editor devices include a preview mode that allows users to verify device performance before writing a configuration to a device.

Setup any Pro Series-enabled device using the free Pro Editor software, available for download at www.bannerengineering.com/proeditor.

To view Pro Series-enabled devices, visit www.bannerengineering.com/proeditor.

¹ Microsoft and Windows are registered trademarks of Microsoft Corporation in the United States and/or other countries.

2 Specifications and Requirements

2.1 Pro Editor Software PC Requirements

Operating System

Microsoft® Windows® operating system versions 7² or 10³

Hard Drive Space

120 MB

USB

Available USB port

Screen Resolution

1366 × 768 full-color minimum

Third-Party Software

.NET version 4.6.2 or higher



Important: Administrative rights are required to install the Pro Editor software.

2.2 Pro Converter Cable – Required for use with Pro Editor

Pro Converter Cable, model MQDC-506-USB, is required for use with Pro Editor. Use the Pro Converter Cable to connect Pro Series-enabled devices to read, write, and preview device states.

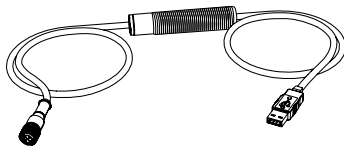

- Connects Pro Series-enabled devices to the PC-based Pro Editor software
- Can be used with mating accessory ACC-PRO-CABLE5 for connection to devices with an integral cable or terminal connection
- Double-ended cordset MQDC-801-5M-PRO required to connect 8-pin devices to Pro Converter Cable; see [Accessories](#) on p. 41 for more information
- Full preview capabilities are available with the use of power supply PSW-24-1 and splitter CSB-M1251FM1251M; see [Accessories](#) on p. 41 for more information



Note: When connected to a Microsoft Windows 10 device for the first time, the Pro Converter Cable automatically installs the correct Microsoft driver. When connected to a Microsoft Windows 7 device for the first time, the Pro Converter Cable drivers must be installed manually. See [Install the Pro Converter Cable Driver \(Windows 7\)](#) on p. 7 for more information.

2.2.1 Model

Model	Adapter	Length	Connections
MQDC-506-USB	Pro Editor Software	1.86 m (6 ft)	USB and 5-pin M12 quick disconnect

² Windows 7 requires manual installation of Pro Converter Cable driver. See [Install the Pro Converter Cable Driver \(Windows 7\)](#) on p. 7 for more information.

³ Microsoft® and Windows® are registered trademarks of Microsoft® Corporation in the United States and/or other countries.

2.2.2 Features

Figure 1. Pro Converter Cable LED Indicators

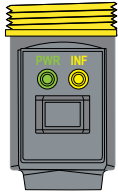

PWR (Cable Power Indicator)

LED Behavior	Condition
Off	No power
Slow flashing green (0.5 Hz)	Normal mode

INF (Device Information Indicator)

LED Behavior	Condition
Off	Device power off
Solid amber	Device power on
Fast flashing red (10 Hz)	Device power fault

2.3 Pro Converter Cable Specifications

Input Voltage

5 V dc from USB Type A connector

Output Voltage

20 V dc

Banner Compatible Devices

View compatible devices at www.bannerengineering.com/proeditor

Certifications



Indicators

2 LED indicators:

Green Flashing: Power on

Amber Solid: Device on

Red Flashing: Device power fault

Communications

5-pin M12 quick disconnect connector compatible with Banner Pro Series-enabled devices

2.4 Banner Engineering Corp. Software Copyright Notice

This software is protected by copyright, trade secret, and other intellectual property laws. You are only granted the right to use the software and only for the purposes described by Banner. Banner reserves all other rights in this software. For so long as you have obtained an authorized copy of this software directly from Banner, Banner grants you a limited, nonexclusive, nontransferable right and license to use this software.

You agree not to use, nor permit any third party to use, this software or content in a manner that violates any applicable law, regulation or terms of use under this Agreement. You agree that you will not reproduce, modify, copy, deconstruct, sell, trade or resell this software or make it available to any file-sharing or application hosting service.

Disclaimer of Warranties. Your use of this software is entirely at your own risk, except as described in this agreement. This software is provided "AS-IS." To the maximum extent permitted by applicable law, Banner, its affiliates, and its channel partners disclaim all warranties, expressed or implied, including any warranty that the software is fit for a particular purpose, title, merchantability, data loss, non-interference with or non-infringement of any intellectual property rights, or the accuracy, reliability, quality or content in or linked to the services. Banner and its affiliates and channel partners do not warrant that the services are secure, free from bugs, viruses, interruption, errors, theft or destruction. If the exclusions for implied warranties do not apply to you, any implied warranties are limited to 60 days from the date of first use of this software.

Limitation of Liability and Indemnity. Banner, its affiliates and channel partners are not liable for indirect, special, incidental, punitive or consequential damages, damages relating to corruption, security, loss or theft of data, viruses, spyware, loss of business, revenue, profits, or investment, or use of software or hardware that does not meet Banner minimum systems requirements. The above limitations apply even if Banner and its affiliates and channel partners have been advised of the possibility of such damages. This Agreement sets forth the entire liability of Banner, its affiliates and your exclusive remedy with respect to the software use. You agree to indemnify and hold Banner and its affiliates and channel partners harmless from any and all claims, liability and expenses, including reasonable attorney's fees and costs, arising out of your use of the Services or breach of this Agreement (collectively referred to as "Claims"). Banner reserves the right at its sole discretion and at its own expense, to assume the exclusive defense and control of any Claims. You agree to reasonably cooperate as requested by Banner in defense of any Claims.

3 Installation Instructions

3.1 Install the Software



Important: Administrative rights are required to install the Pro Editor software.

1. Download the latest version of the software from www.bannerengineering.com/proeditor.
2. Navigate to the downloaded file **ProEditorInstaller.exe**.
3. Double-click the installer to open **Banner Pro Editor Setup**.
4. Accept the terms in the License Agreement by selecting the checkbox.
5. Click **Install** to install the software.
6. Depending on your system settings, a pop-up window may appear prompting to allow Pro Editor to make changes to your computer. Click **Yes**.
7. Click **Close** to exit the installer after installation is complete.

3.1.1 Update the Software

The current version of the Pro Editor software is available for download from www.bannerengineering.com/proeditor.

When connected to a network, if a Pro Editor software update is available, a red icon  displays in the bottom right corner of Pro Editor. See [Device Connection Status and Software Update Notification](#) on p. 33 for more information.

3.2 Install the Pro Converter Cable Driver (Windows 7)

When connected to a PC running Microsoft Windows 7 for the first time, the Pro Converter Cable drivers must be installed manually. To manually install the Pro Converter Cable driver on a Windows 7 device, follow these steps.



Note: After connecting the Pro Converter Cable to a PC running Microsoft Windows 7 the following message may appear: "Device driver software not successfully installed".

1. Download the latest driver file from www.bannerengineering.com/proeditor.
2. Unzip (extract) the file labeled ProConverterCable_driver to a new location.
3. Open **Control Panel**.
4. Open **Device Manager** (in the System and Security category). The Pro Converter Cable is listed as **Communications Translator** under **Other Devices** with an exclamation mark icon next to it indicating that the device driver has not been successfully installed.
5. Right-click on **Communications Translator** and select **Update Driver Software...**
6. Click **Browse my computer for driver software**.
7. Click on **Com ports**.
8. Click **Let me pick from a list of device drivers on my computer**.
9. Make sure that **Show All Devices** is selected and click **Next**.
10. Click **Have Disk...**
11. Click **Browse...** and select the driver file. For example, banner0x00D2_cdc.inf.
12. Click **OK**.
13. A message displays that the driver has an Authenticode signature. Click **Next**.
14. An update driver warning displays. Click **Yes**.
15. An installation message displays. Click **install**.

The Pro Converter Cable is listed as a COM Port under Ports in **Device Manager**.

3.3 Connect the Cables

There are two options for connecting a Pro Series-enabled device to Pro Editor.

1. Connect a device using a Pro Converter Cable, splitter, and power supply for full preview capabilities. This configuration is required for the TL50 Pro Tower Light, the WLS15 Pro Strip Light, the K90 Pro Indicator, and WLS27 Pro Strip Light. For more information, refer to the [Pro Devices Technical Note](#) (p/n b_4485056).
2. Connect a device using a Pro Converter Cable for limited preview capabilities.



Note: If your Pro Series-enabled device has an integral cable or terminal connection, a mating accessory (ACC-PRO-CABLE5) is required to connect the device to the Pro Converter Cable. See [Accessories](#) on p. 41 for more information.



Note: If your Pro Series-enabled device has an 8-pin connector, a double-ended cordset (MQDC-801-5M-PRO) is required to connect the device to the Pro Converter Cable. See [Accessories](#) on p. 41 for more information.

3.3.1 Full Preview Connection (Recommended)

The full preview connection must be used for the TL50 Pro Tower Light, the K90 Pro Indicator, and for Pro-series Strip Lights, and is optional but recommended for other Pro-series enabled devices.

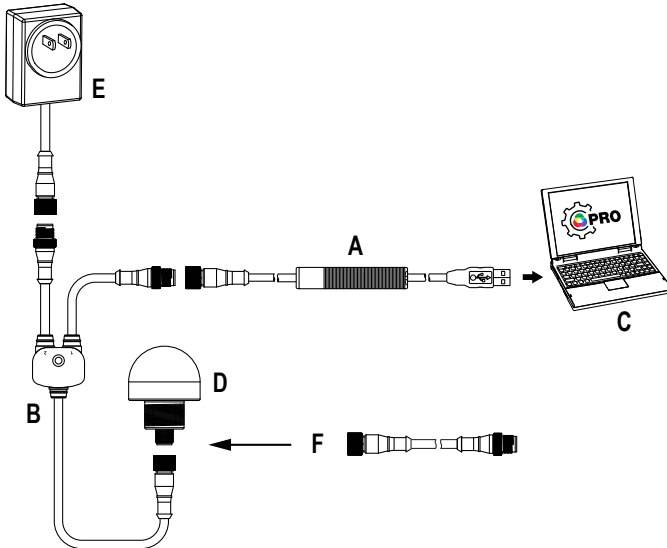

- A = Pro Converter Cable (MQDC-506-USB)
- B = Splitter (CSB-M1251FM1251M)
- C = PC running Pro Editor software
- D = Any Banner Pro Series-enabled device (K50 shown)
- E = Power Supply (PSW-24-1 or PSD-24-4)
- F = 8-Pin to 5-Pin Double-Ended Cordset (MQDC-801-5M-PRO), required for 8-Pin models

3.3.2 Limited Preview Connection

Because of supply current restrictions when using a Pro Converter Cable to connect a device to Pro Editor, some preview features may be unavailable, including certain animations and colors. For information regarding device preview capabilities when using a Pro Converter Cable setup, contact a Banner applications engineer.

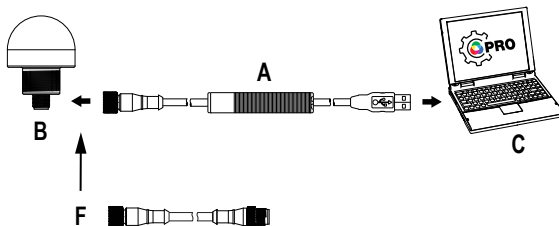

- A = Pro Converter Cable
- B = Banner Pro Series-enabled device
- C = PC running Pro Editor software
- F = 8-Pin to 5-Pin Double-Ended Cordset (MQDC-801-5M-PRO), required for 8-Pin models

3.4 Connect a Device

After connecting a Pro Series-enabled device to a PC, follow these steps to connect the device to Pro Editor. Only one device can be connected to Pro Editor at a time.

1. Open Pro Editor.

Figure 2. Pro Editor



2. Click **Connect**.

Figure 3. Pro Editor Connection Dialog

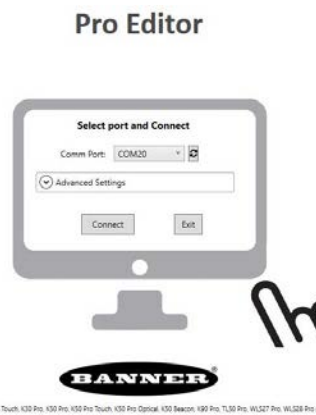

3. Select the Comm Port from the drop-down list. If the communication port that you have connected the device to is not available, click the refresh button and then select the comm port from the drop-down list.
4. Click **Connect**.
5. When a device is successfully connected, the following message appears:

Figure 4. Successful Connection

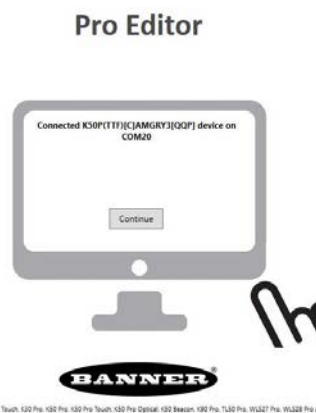

6. Click **Continue**.



Note: For information regarding Advanced Settings, contact a Banner applications engineer.

After a device is successfully connected, Pro Editor reads the device configuration and displays it.

4 Navigating Pro Editor

Pro Editor provides access to read, write, and preview device states.



Note: This Instruction Manual covers Pro Editor v2.2. Interface and functionality details may be different in other versions of Pro Editor.

Figure 5. Pro Editor Configuration Navigation – K50 Pro Touch Shown

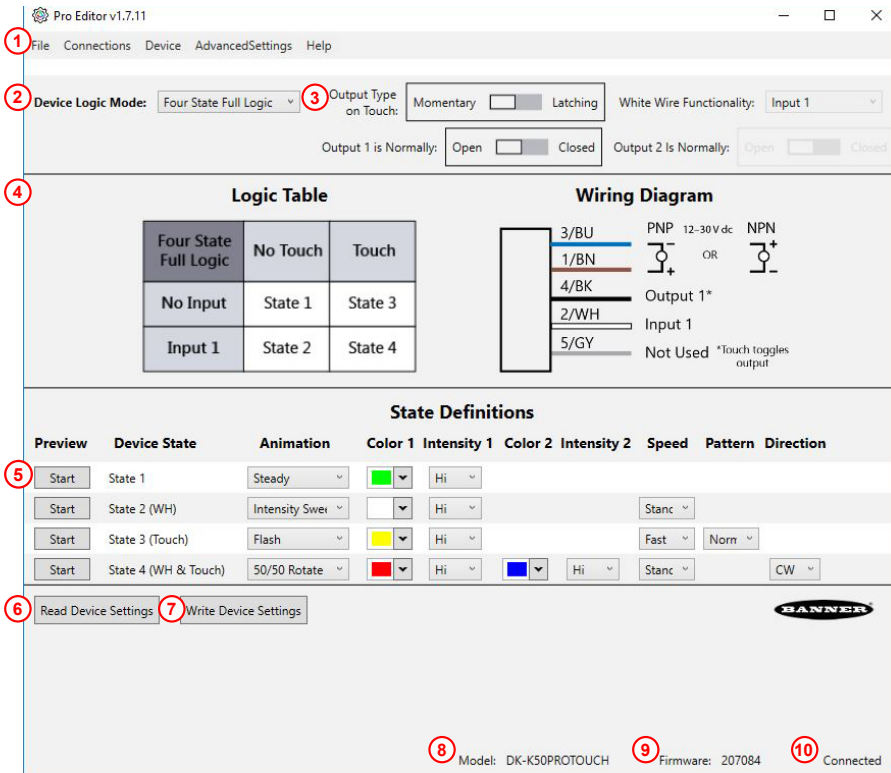

Key for Indicator, Touch, and Tower Light Devices

1. Menu Bar: File, Connections, Device, AdvancedSettings, Help
2. Device Logic Mode* or I/O State** Drop-down
3. Global Parameters*
4. Logic Table and Wiring Diagram*
5. Device Function Rows
6. Read Device Settings
7. Write Device Settings
8. Connected Device Information
9. Connected Device Firmware ID
10. Device Connection Status and Software Update Notification

*Touch device configuration only, Global Parameters change depending on the connected device

** Indicator device configuration only

Figure 6. Pro Editor Configuration Navigation – WLS27 Pro Shown

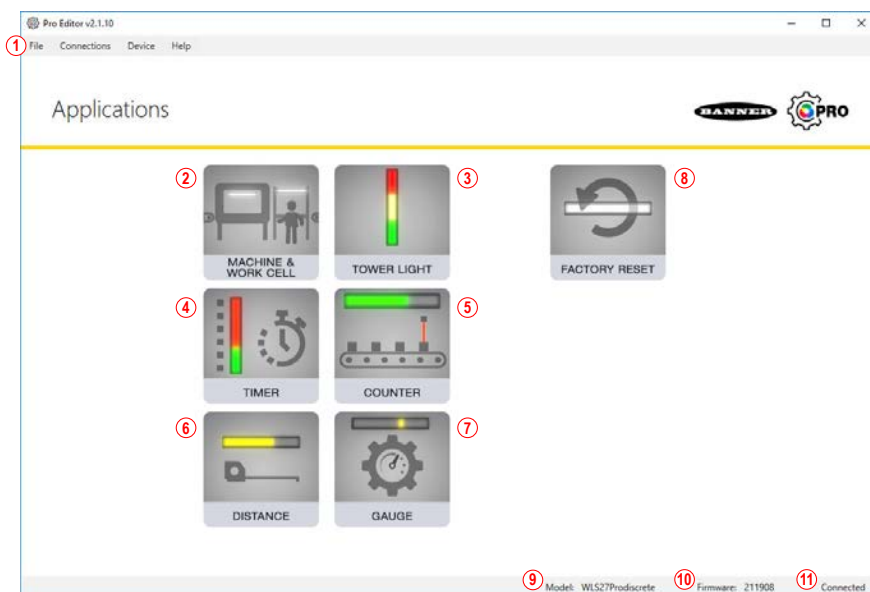



Key for Strip Light Devices

1. Menu Bar: File, Connections, Device, Help
2. Machine & Work Cell Application
3. Tower Light Application
4. Timer Application
5. Counter Application
6. Distance Application
7. Gauge Application
8. Factory Reset
9. Connected Device Information
10. Connected Device Firmware ID
11. Device Connection Status and Software Update Notification

4.1 Menu Bar

File Menu Option	Description
Save Current Config	Saves the current configuration.
Open Config File	Opens a saved configuration file.
Exit	Exit Pro Editor.

Connections Menu Option	Description
Connect	Opens the Connection dialog.
Disconnect	Disconnects the connected Pro Series-enabled device.

Device Menu Option	Description
Open Legacy Default Template	<p>Loads the selected Legacy configuration to replicate the functionality of select factory configured devices.</p> <p> Note: Menu option only available on touch devices.</p>
Restore Device Factory Configuration	<p> Important: Performing a Restore Device Factory Configuration deletes the configuration stored on the connected device and replaces it with the default factory configuration.</p> <p>To restore a device to its factory configuration, select Restore Device Factory Configuration. The current configuration on the device is deleted and replaced by the factory configuration, which will then be read by Pro Editor. If the Device Logic Mode drop-down reads "--Please Select--", manually select the appropriate logic mode.</p>



Note: **Advanced Settings** is only available when a K50 Pro Touch or TL50 Pro Tower Light is connected to Pro Editor.

Click **Advanced Settings** to open the **Advanced Settings** configuration display. For more information, see [Global Parameters and Advanced Settings](#) on p. 14.

Help—This Instruction Manual is accessible from within Pro Editor under **Help**.

4.2 Indicator Devices

Depending on the device connected to Pro Editor, one of three configuration parameters displays:

- When an indicator device is connected, **I/O State** configuration displays.
- When a touch device is connected, **Device Logic Mode** configuration displays. For touch device configuration, see [Touch Devices](#) on p. 12.
- When a WLS27 or WLS15 is connected, a common applications selection displays. See [Strip Light Devices](#) on p. 20.

By default, when an indicator device is connected, Pro Editor opens **I/O State** configuration in **Advanced**. Three **I/O States** are available:

- Basic
- Advanced
- I/O Block

4.2.1 I/O State – Basic

Four state control. Configurations made in I/O State Basic assign one wire to one state, with the following override control:

- Pin 1 (Brown) overrides Pin 4 (Black)

- Pin 2 (White) overrides Pins 1 and 4 (Brown and Black)
- Pin 5 (Gray) overrides Pins 1, 2, and 4 (Brown, White, and Black)

4.2.2 I/O State – Advanced

Default I/O state with full 15 state options for maximum configurability. Configurations made in Advanced assign binary wiring combinations of all valid inputs to each state.

4.2.3 I/O State – I/O Block

Three state control for use with I/O block. Configurations made in I/O Block assign states to the black, white, and combination of black and white wires for use with I/O blocks for which power (brown) and common (blue) are always on for five pin connections.

4.3 Touch Devices

Depending on the device connected to Pro Editor, one of two configuration parameters displays:

- When a touch device is connected, **Device Logic Mode** configuration displays.
- When an indicator device is connected, **I/O State** configuration displays. For indicator device configuration, see [Indicator Devices](#) on p. 11.

By default, when a touch device is connected, Pro Editor opens **Device Logic Mode** configuration populated with the configuration written to the device. If no device logic mode is selected, use the **Device Logic Mode** drop-down to select a logic mode, then write the configuration to the device. Three **Device Logic Modes** are available:

- Four State Full Logic
- Three State Advanced Control
- Seven State Advanced Control

4.3.1 Device Logic Mode – Four State Full Logic

When using Four State Full Logic, four device states are activated by one input wire and the touch button. The touch button also toggles the output(s).

Assuming power is on using the blue and brown wires:

State 1: Input Inactive, Touch Inactive

State 2: Input Active, Touch Inactive

State 3: Input Inactive, Touch Active

State 4: Input Active, Touch Active

Figure 7. Four State Full Logic Table – Pro Editor

Four State Full Logic	No Touch	Touch
No Input	State 1	State 3
Input 1	State 2	State 4

5-Pin/5-Wire Pro Devices ⁴

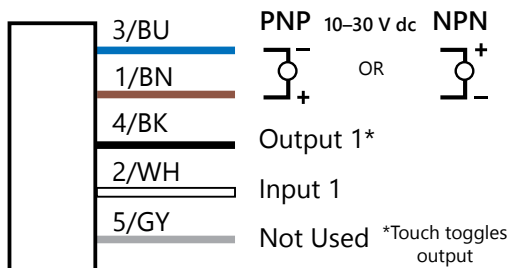

8-Pin/6-Wire Models (S22 Pro Touch Devices Only) ⁴

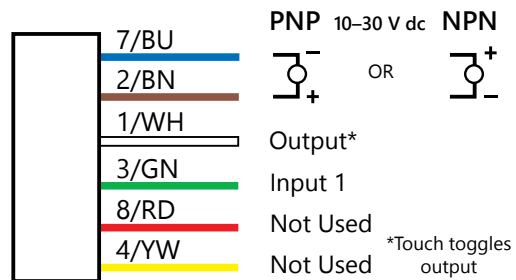

⁴ Voltage values shown in wiring diagrams vary depending on the connected device.

8-Pin/8-Wire Models (K50 Pro Touch Devices Only) ⁴

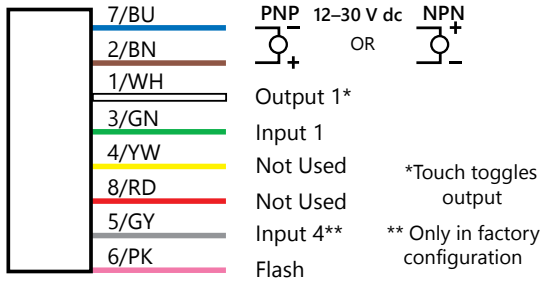

4.3.2 Device Logic Mode – Three State Advanced Control

When using Three State Advanced Control, four device states are activated by two input wires. The touch button toggles the output(s) with no device state change. ⁵

Figure 8. Three State Advanced Control Table – Pro Editor

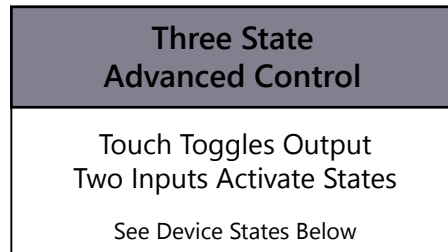

5-Pin/5-Wire Pro Devices ⁴

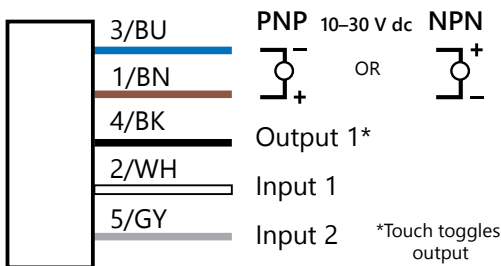

8-Pin/6-Wire Models (S22 Pro Touch Devices Only) ⁴

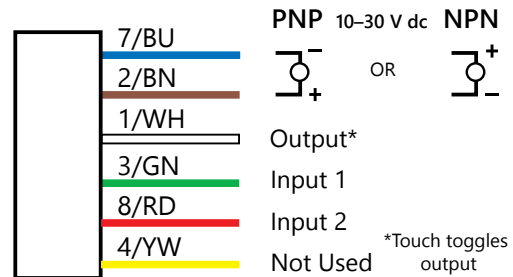

8-Pin/8-Wire Models (K50 Pro Touch Devices Only) ⁴

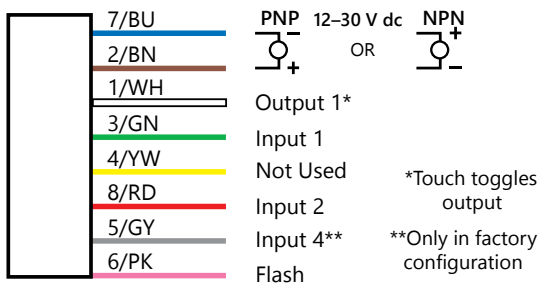

⁵ When configuring a 5-Wire K50 Pro Touch device to use two outputs, the Three State Advanced Control Device Logic Mode has two device states that are toggled by a single input wire.

4.3.3 Device Logic Mode – Seven State Advanced Control



Note: Seven State Advanced Control is only available on 8-Pin (6-Wire or 8-Wire) Pro Series-enabled devices.

When using Seven State Advanced Control, seven device states are activated by three input wires. An additional power state can be defined. The touch button toggles the output(s) with no device state change.

Figure 9. Seven State Advanced Control Table – Pro Editor



8-Pin/6-Wire Models (S22 Pro Touch Devices Only) ⁴

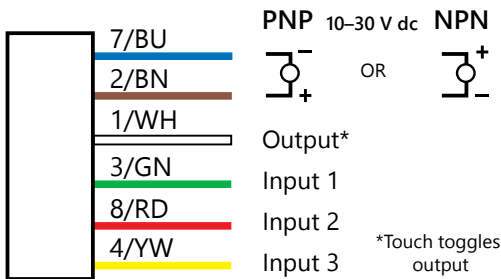

8-Pin/8-Wire Models (K50 Pro Touch Devices Only) ⁴

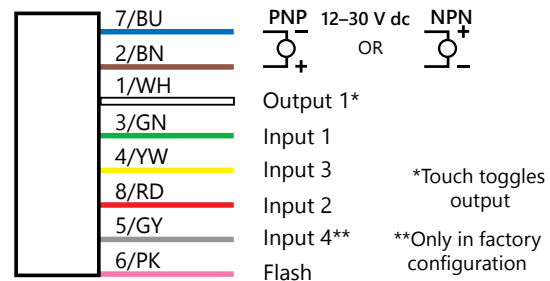

4.3.4 Global Parameters and Advanced Settings

Depending on the connected Pro Series-enabled device, the following global parameters appear in the configuration display.

Figure 10. S22 Pro Touch Global Parameters – Pro Editor

Output is Normally: Open Closed

Touch "On" Delay (ms):

Output Type on Touch: Momentary Latching

Touch "Off" Delay (ms):

S22 Touch Parameter	Description
Output is Normally	In Open mode, the output is turned ON with touch input. In Closed mode, the output is turned OFF with touch input.
Output Type on Touch	In Momentary mode, the output is toggled only while the touch button is touched. In Latching mode, the output toggles each time the touch button is pressed. ⁶
Touch "On" Delay (ms)	The length of time the touch button needs to be pressed to trigger "touch active" state.
Touch "Off" Delay (ms)	The length of time before the device returns to "touch inactive" state after the touch button is released.

Figure 11. K50 Pro Touch Global Parameters – Pro Editor

Output Type on Touch: Momentary Latching

Gray Wire Functionality: Output 2

Output 1 is Normally: Open Closed

Output 2 is Normally: Open Closed

⁶ When **Output Type on Touch** is set to Latching mode, output state and device state transitions both occur on the leading edge of touch input.

K50 Pro Touch Parameter	Description
Output Type on Touch	In Momentary mode, the output only toggles while the touch button is touched. In Latching mode, the output toggles each time the touch button is pressed. ⁶
Output 1 is Normally	In Open mode, output 1 is turned ON with touch input. In Closed mode, output 1 is turned OFF with touch input.
White/Gray Wire Functionality ⁷	Determines whether the configurable wire should behave as an input or an output.
Output 2 is Normally	In Open mode, output 2 is turned ON with touch input. In Closed mode, output 2 is turned OFF with touch input.

When a K50 Pro Touch device is connected, the following **Advanced Settings** can be accessed by clicking on the **AdvancedSettings** menu.

K50 Pro Touch Setting	Description
Touch "On" Delay (ms)	The length of time the touch button needs to be pressed to trigger "touch active" state.
Touch "Off" Delay (ms)	The length of time before the device returns to "touch inactive" state after the touch button is released.
Touch Sensitivity	The touch button is easily toggled in High mode, and resists unintentional toggling in Low mode.
Remember Touch State on Power Loss	When the Global Parameter Output Type on Touch is set to Latching the Remember Touch State on Power Loss setting, determines whether touch state should be reset or retained when power is restored. When ON the touch state will be retained when power to the device is lost. When OFF the touch state will be reset when power to the device is lost.

Figure 12. K50 Pro Touch Advanced Settings – Pro Editor

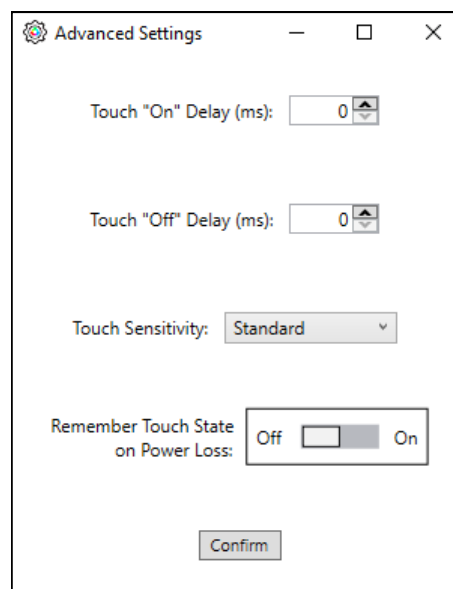

4.4 Tower Light Devices

Set tower light parameters for three modes:

- Segment mode
- Run mode
- Advanced mode

The wiring diagrams for tower light devices are updated based on the input wires selected for each mode. By default, tower lights are in segment mode. For more information about segment mode default inputs, see the TL50 Pro Tower Light datasheet (p/n [209142](#)).

All wiring diagrams display a seven segment tower light. For devices that do not have seven segments, the wiring diagram shows these inputs/segments as NOT PRESENT.

4.4.1 Tower Light Segment Mode

Use Segment Mode to activate each segment and to control the input wire, color, animation, intensity, and speed. For information about the animation settings, see [Animation](#) on p. 35. In Segment Mode, a single input can be assigned to one or multiple segments. The dedicated audible input overrides audible functions that have been assigned to segment inputs.

⁷ The configurable wire color depends on the wire count of the connected device. 5-Wire devices do not allow for custom wire configuration when in Four State Full Logic Mode. See [Device Logic Mode – Four State Full Logic](#) on p. 12.

Figure 13. Wiring diagram for Segment Mode

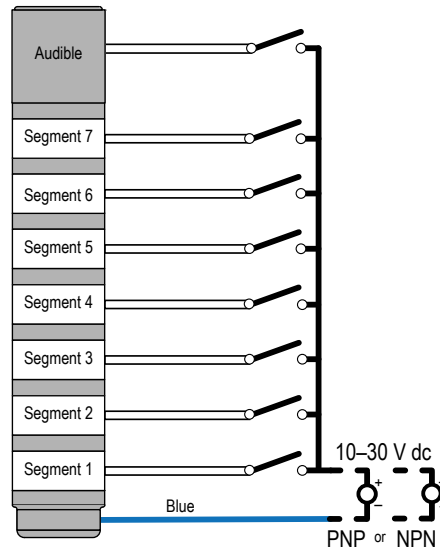

Figure 14. Segment Mode settings

State Definitions: Segments											
Preview	Segment	Wire	Animation	Color 1	Intensity	Color 2	Intensity	Speed	Pattern	Direction	Audible
Start	Audible	Gray (5)									Off
Start	3	White (2)	Steady	Red	Hi						Off
Start	2	Brown (1)	Steady	Yellow	Hi						Off
Start	1	Black (4)	Steady	Green	Hi						Off
Action		Disable									

In **Segment Mode**, enable the **Action Input** to switch between Segment Mode and Action Mode (all segments) animations depending on wiring. The Action Input can be selected from a list of any unused segment input wires. If all input wires are in use, an Action Input cannot be selected. The combination of the **Action Input** and the Segment input controls all tower light segments at once. The input priority follows the segment position. The input for the highest segment on the tower light and the **Action Input** is highest priority and the input for the lowest segment on the tower light and the **Action Input** is the lowest priority.

Figure 15. Wiring diagram for Action Input

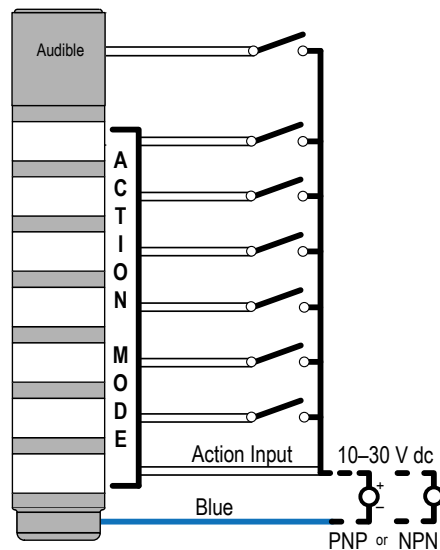

Figure 16. Action Input settings

State Definitions: Segments											
Preview	Segment	Wire	Animation	Color 1	Intensity	Color 2	Intensity	Speed	Pattern	Direction	Audible
Start	Audible	Disable									Off
Start	3	White (2)	Steady	Red	Hi						Off
Start	2	Brown (1)	Steady	Yellow	Hi						Off
Start	1	Black (4)	Steady	Green	Hi						Off
	Action	Gray (5)									

State Definitions: Actions												
Preview	Function	Wires	Animation	Color 1	Intensity 1	Color 2	Intensity 2	Speed	Pattern	Direction	Shift	Audible
Start	Action 4	White (2) + Gray (5)	Steady	Green	Hi							Off
Start	Action 3	Brown (1) + Gray (5)	Steady	Green	Hi							Off
Start	Action 2	Black (4) + Gray (5)	Steady	Green	Hi							Off
Start	Action 1	Gray (5)	Steady	Green	Hi							Off

4.4.2 Tower Light Run Mode

Use the TL50 Pro's Run Mode to control the entire tower light and to control the input wire, color, animation, intensity, and speed.

A Run Mode with a larger assigned run number overrides the lower assigned run numbers. If present, an audible function can be assigned per Run Mode state or as a separate input. The dedicated audible input overrides audible functions that have been assigned to individual Run Mode states.

For information about the animation settings, see [Animation](#) on p. 35.

Figure 17. TL50 Pro wiring diagram for Run Mode

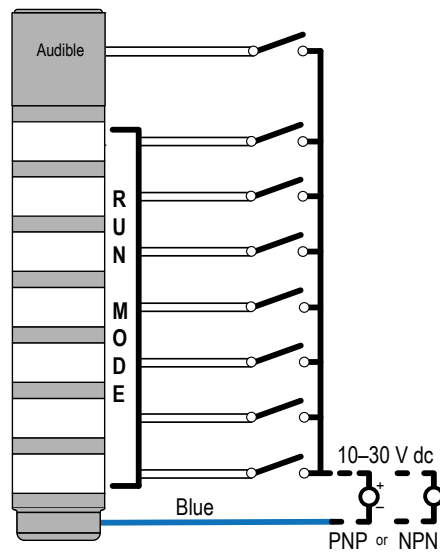

Figure 18. Run Mode settings

State Definitions												
Preview	Function	Wires	Animation	Color 1	Intensity 1	Color 2	Intensity 2	Speed	Pattern	Direction	Shift	Audible
Start	Audible	Disable										Off
Start	Run 4	Gray (5)	Steady	Green	Hi							Off
Start	Run 3	White (2)	Steady	Green	Hi							Off
Start	Run 2	Brown (1)	Steady	Green	Hi							Off
Start	Run 1	Black (4)	Steady	Green	Hi							Off

4.4.3 Tower Light Advanced Mode

Use Advanced Mode to set the value range, thresholds, colors, intensities, flash speeds, and animation types for PWM, PFM, Counter, and Timer control inputs. The advanced mode wiring diagram is updated based on the selected control type. Reference the wiring tables for more information about wire assignments.

Figure 19. TL50 Pro wiring diagram for Advanced Mode

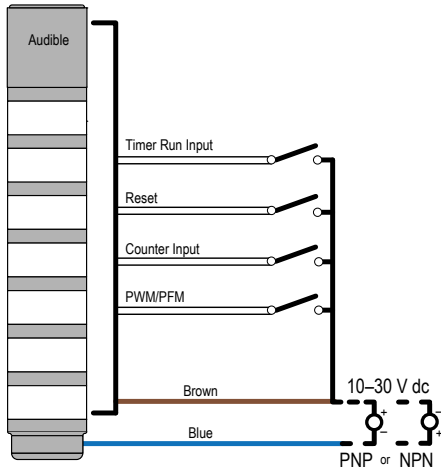

5-pin/Wire Models		
Pin	Color	Advanced Mode
3	blue	Common (PNP) or 10–30 V dc (NPN)
4	black	Reset Input
1	brown	10–30 V dc (PNP) or Common (NPN)
2	white	PWM, PFM, Counter, or Timer Run Input
5	gray	N/A

8-pin/Wire Models		
Pin	Color	Advanced Mode
7	blue	Common (PNP) or 10–30 V dc (NPN)
6	pink	Reset Input
2	brown	10–30 V dc (PNP) or Common (NPN)
1	white	PWM, PFM, Counter, or Timer Run Input
5	gray	N/A
4	yellow	N/A
8	red	N/A
3	green	N/A

Advanced Mode allows the selection of four control types: PFM, PWM, Counter or Timer. Reference the Advanced Mode Parameters table for more information about each input type and their associated parameters. The value units change based on the control type: Hz (PFM), % (PWM), seconds (Timer) or pulses (Counter).

Define an animation state for a background, base, and up to four thresholds. Reference the Advanced Mode Parameters table for more information about threshold definitions. A value percentage can be defined for each threshold. The equivalent units, based on the defined value range, are shown next to the threshold percentage.

Figure 20. Advanced Mode settings

Threshold Type	Value	Animation	Color 1	Intensity 1	Color 2	Intensity 2	Speed	Pattern	Direction Shift	Audible
Background										Off
Base		Steady	Yellow	Hi						Off
Threshold	≤ 20 %	200 Hz	Steady	Green	Hi					Off
Threshold	≤ 40 %	300 Hz	Steady	Blue	Hi					Off
Threshold	≤ 60 %	400 Hz	Steady		Hi					Off
Threshold	≥ 80 %	500 Hz	Steady	Red	Hi					Off

Advanced Mode Parameters	Description
Control Type	PWM (Pulse Width Modulation): Apply a square wave signal to the PWM/PFM Input and vary the duty cycle from 0 to 100% to set value. The signal must use a constant frequency between 100 to 10,000 Hz.
	PFM (Pulse Frequency Modulation): Apply a square wave signal to the PWM/PFM Input and vary the frequency from 100 to 10,000 Hz to set the value. The signal must use a constant duty cycle from 10 to 90%.
	Counter: Apply a single pulse to the Counter Input to change the value by 1. Apply a single pulse to the Reset Input to set the value to the starting value, if enabled. The pulse signal must last a minimum of 16 ms; the value changes on the leading edge.
	Timer: Apply constant power to the tower to change the value by 1 every 1 second. Use a constant on or off signal on the Timer Run Input to start and pause the timer, respectively, if enabled. Apply a pulse to the Reset Input to set the value to the starting value, if enabled. The pulse signal must last a minimum of 16 ms; the value changes on the leading edge.
Subsegment Style	If the value is a partial percentage of a segment, select if segment will be on steady or analog dimmed to the partial percentage
Start From	Top: The value decreases from the maximum value Bottom: The value increases from the minimum value
Reset Input	Apply a pulse signal to the Reset Input to set the value to the starting value, if enabled. The pulse signal must last a minimum of 16 ms.
Threshold Dominance	Dominant: All segments display the active threshold color Non-Dominant: Segments display their defined threshold color
Threshold Type: Background	A defined color and intensity is displayed on segments that are not active
Threshold Type: Base	A defined animation state is displayed on segments that are not defined within a threshold
Threshold Type	≤: The animation state is displayed on the segments that are less than or equal to the defined threshold ≥: The animation state is displayed on the segments that are greater than or equal to the defined threshold Disabled: The threshold is disabled



Note: In PWM and PFM mode, an increasing control signal increments the tower light from bottom (connection end) to top. To display the same behavior for a decreasing control signal, invert the high and low values.



Note: A threshold at any percentage can be defined. However, when in non-dominant mode, the threshold transition only occurs at a segment transition. In dominant mode, the threshold transition occurs at the defined threshold. For example, when in non-dominant mode, if a threshold is set at the middle of a tower light segment, the transition is not seen until the value reaches the next segment. To calculate the percentage of each segment transition, divide the number of tower light segments by 100.

4.4.4 Global Parameters and Advanced Settings

In the File menu, click on Advanced Settings to see additional parameters that can be defined for Segment Mode or Advanced Mode. Reference the Global Parameters and Advanced Settings table for more information about each parameter.

Figure 21. Advanced Settings screen

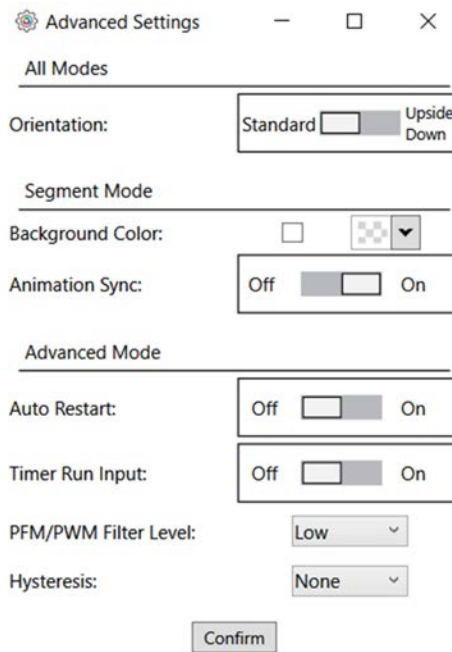

Global Parameters and Advanced Settings	Description
Orientation	Standard: The tower base is down Upside Down: The tower base is up
Background Color	A defined color and intensity is displayed on segments that are not active
Animation Sync	On: Segment animations align when any input state changes Off: Segment animations will not be synchronized
Auto Restart	On: The counter and timer will reset to the starting value after reaching the end value Off: The counter and timer will stop at the ending value
Timer Run Input	Use a constant on or off signal on the Timer Run Input to start and to pause the timer, respectively, if enabled
PFM/PWM Filter Level	Smooths the input signal by varying the sample size Low: The sample size is short and changes to the input signal are more noticeable High: The sample size is long and changes to the input signal are less noticeable
Hysteresis	Determines the signal value change needed to transition between thresholds and to prevent chatter None: The value follows the input signal High: A large value change is needed to transition between thresholds

4.5 Strip Light Devices

Set strip light parameters for the following applications:

- Machine and Work Cell

- Tower Light
- Timer
- Counter
- Distance
- Gauge
- Mobile (WLS15 Pro only)
- Pick Put Build (WLS15 Pro only)

4.5.1 Application: Machine and Work Cell

Choose colors and animations to create up to seven discretely controlled illumination and status states. Spans functionality from single segment to two-colored animations.

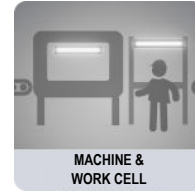

By default, when the sub-applications for Machine and Work Cell are selected, Pro Editor opens **I/O State** configuration in **Advanced**. Three **I/O states** are available:

I/O State Configuration Settings	Description
Basic	Configurations made in this state assign one wire to one state, with the following override control: <ul style="list-style-type: none"> • Pin 4 (Black) overrides Pin 1 (Brown) • Pin 2 (White) overrides Pins 1 and 4 (Brown and Black)
Advanced	I/O state with full seven state options for maximum configuration. Configurations made in Advanced assign binary wiring combinations of all valid inputs to each state.
I/O Block	Three state control for use with I/O block. Configurations made in I/O Block assign states to the black, white, and combination of black and white wires for use with I/O blocks for which power (brown) and common (blue) are always on for five pin connections.

Single Segment

The single segment option shows the strip light in one solid color. The input wires are used to change colors. Flashing and intensity options are available. Presets are available for common configurations, which can be adjusted as desired.



Figure 22. Single segment settings

Choose I/O states: Advanced

Presets: White Temp White Dim EZ STATUS RGB

Input Wire Connections	Flash	Segment Color	Intensity	Speed	Pattern
Brown(Pin 1):	<input type="checkbox"/> Flash	Daylight White	High	Standard	Normal
Black(Pin 2):	<input type="checkbox"/> Flash	Green	High	Standard	Normal
White(Pin 4):	<input type="checkbox"/> Flash	Red	High	Standard	Normal
Brown/Black:	<input type="checkbox"/> Flash	Yellow	High	Standard	Normal
Brown/White:	<input type="checkbox"/> Flash	Blue	High	Standard	Normal
Black/White:	<input type="checkbox"/> Flash	Daylight White	High	Standard	Normal
All:	<input type="checkbox"/> Flash	Warm White	High	Standard	Normal

Read Write

End Status

The end status option shows the inside section of the strip light in one color and the ends of the light in another. The size of the two sections are customizable. The input wires are used to change color states. Flashing and intensity options are available.



Figure 23. End status settings

Choose I/O states:

Presets:

Input Wire Connections	Ends	Segment Colors		Intensities		Speed	Pattern	Center%
		Center	Ends	Center	Ends			
Brown(Pin 1):	<input type="checkbox"/> Flash	Daylight White	Red	High	High	Standard	Normal	50
Black(Pin 2):	<input type="checkbox"/> Flash	Green	Red	High	High	Standard	Normal	50
White(Pin 4):	<input type="checkbox"/> Flash	Red	Red	High	High	Standard	Normal	50
Brown/Black:	<input type="checkbox"/> Flash	Yellow	Red	High	High	Standard	Normal	50
Brown/White:	<input type="checkbox"/> Flash	Blue	Red	High	Med	Standard	Normal	20
Black/White:	<input checked="" type="checkbox"/> Flash	Daylight White	Red	High	High	Standard	Normal	60
All:	<input type="checkbox"/> Flash	Warm White	Red	High	High	Standard	Normal	50

Process Visualization

The process visualization option enables a choice of colors, animations, speeds, and intensities to provide visual information that corresponds to equipment or process status. Single color illumination states are also available.



Figure 24. Process visualization settings

Choose I/O states:

Presets:

Input Wire Connections	Animation	Colors		Intensities		Speed	Pattern
		Color 1	Color 2	Color 1	Color 2		
Brown(Pin 1):	Steady	Daylight White		High		Standard	Normal
Black(Pin 2):	Steady	Green		High		Standard	Normal
White(Pin 4):	Steady	Red		High		Standard	Normal
Brown/Black:	Steady	Yellow		High		Standard	Normal
Brown/White:	Bounce	Blue	Red	High	Med	Standard	Normal
Black/White:	Ends Flash	Daylight White	Red	High	High	Standard	Normal
All:	Steady	Warm White		High		Standard	Normal

4.5.2 Application: Tower Light

Choose colors and animations to create a discretely controlled two or three segment indicator.



Two Segment

The two segment option uses the strip light as a tower light with two defined segments. The segments are controlled independently with input wires. Animations, colors, and intensities are configurable.

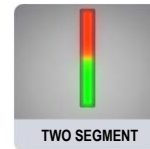

Figure 25. Two segment settings

Presets: Standard Settings

Segments	Animation	Colors		Intensities	
		Color 1	Color 2	Color 1	Color 2
Seg 2 - Top: <small>(Brown, Pin 1)</small>	Steady	Red		High	
Seg 1 - Connector: <small>(Black, Pin 4)</small>	Steady	Green		High	

Read Write

Three Segment

The three segment option uses the strip light as a tower light with three defined segments. The segments are controlled independently with input wires. Animations, colors, and intensities are configurable.



Figure 26. Three segment settings

Presets: Standard Settings

Segments	Animation	Colors		Intensities	
		Color 1	Color 2	Color 1	Color 2
Seg 3 - Top: <small>(White, Pin 2)</small>	Steady	Red		High	
Seg 2: <small>(Brown, Pin 1)</small>	Steady	Yellow		High	
Seg 1 - Connector: <small>(Black, Pin 4)</small>	Steady	Green		High	

Read Write

4.5.3 Application: Timer

Set a total time and up to four thresholds. Start and stop the timer counting up or down with discrete control. Colors change across threshold values.



Basic Timer

The timer option uses the strip light as a timer, counting up or counting down. Thresholds are available to change the visual appearance of the light as time advances. The timer starts when the supply voltage is applied to the timer run input wire, and paused when left floating or tied to ground. The timer resets when the supply voltage is applied to the reset wire. The timer automatically resets when it reaches the final count. Threshold markers⁸ can be applied, from which color and intensity can be defined.



Figure 27. Basic timer settings

Count seconds: Direction: Dominance: Threshold Marker: Marker color: Marker Intensity:

Presets:

Threshold	Enabled	Percent	Seconds	Flash	Color	Intensity	Speed	Pattern
#4 - Top:	<input checked="" type="checkbox"/>	<input type="text" value="100"/>	5	<input type="checkbox"/>	<input type="button" value="Red"/>	<input type="button" value="High"/>	<input type="button" value="Standard"/>	<input type="button" value="Normal"/>
#3:	<input checked="" type="checkbox"/>	<input type="text" value="75"/>	4	<input type="checkbox"/>	<input type="button" value="Yellow"/>	<input type="button" value="High"/>	<input type="button" value="Standard"/>	<input type="button" value="Normal"/>
#2:	<input checked="" type="checkbox"/>	<input type="text" value="50"/>	3	<input type="checkbox"/>	<input type="button" value="Blue"/>	<input type="button" value="High"/>	<input type="button" value="Standard"/>	<input type="button" value="Normal"/>
#1 - Connector:	<input checked="" type="checkbox"/>	<input type="text" value="25"/>	1	<input type="checkbox"/>	<input type="button" value="Green"/>	<input type="button" value="High"/>	<input type="button" value="Standard"/>	<input type="button" value="Normal"/>

Timer with Background

The timer option uses the strip light as a timer, counting up or counting down. Thresholds are available to change the visual appearance of the light as time advances. The timer starts when the supply voltage is applied to the timer run input wire, and paused when left floating or tied to ground. The timer resets when the supply voltage is applied to the reset wire. The timer automatically resets when it reaches the final count. A steady global background or threshold markers⁸ can be applied, from which color and intensity can be defined.



⁸ Threshold markers only apply to WLS15 Pro devices.

Figure 28. Timer with background settings

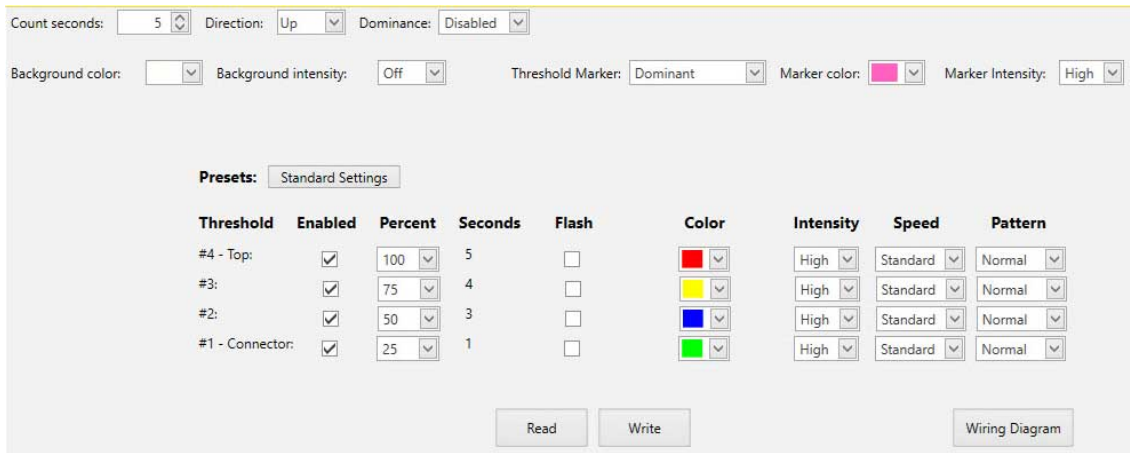
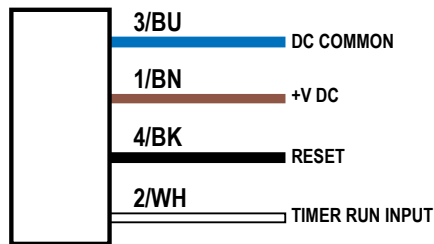

Figure 29. Wiring diagram for timer



4.5.4 Application: Counter

Set a total count and up to four thresholds. Discrete, rising edge pulses count up or down. Colors change across threshold values.



Basic Counter

The counter option converts input pulses to movement of LEDs along the length of the light based on thresholds that define colors, intensity, and flashing. When the rising edge of the supply voltage pulse is applied to the counter input wire, the count changes by one. The counter resets when the supply voltage is applied to the reset wire. The counter automatically resets when it reaches the final count. Threshold markers⁹ can be applied, from which color and intensity can be defined.



⁹ Threshold markers only apply to WLS15 Pro devices.

Figure 30. Basic counter settings

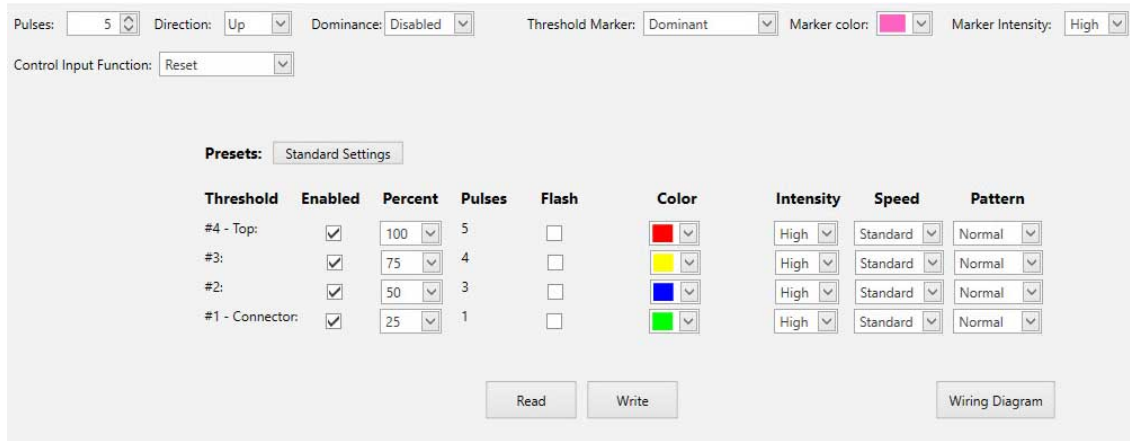

Counter with Background

The counter option converts input pulses to movement of LEDs along the length of the light based on thresholds that define colors, intensity, and flashing. When the rising edge of the supply voltage pulse is applied to the counter input wire, the count changes by one. The counter resets when the supply voltage is applied to the reset wire. The counter automatically resets when it reaches the final count. A steady global background or threshold markers¹⁰ can be applied, from which color and intensity can also be defined.



Figure 31. Counter with background settings

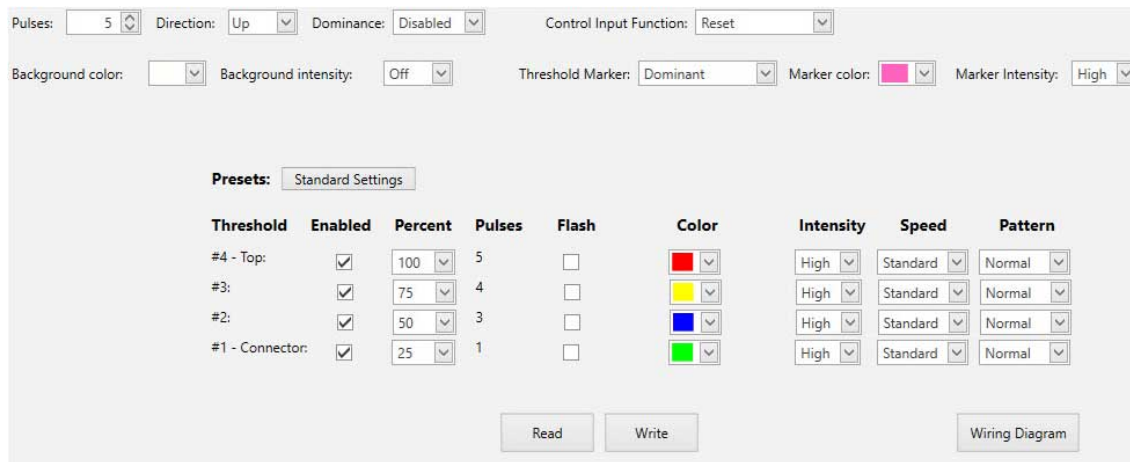

Figure 32. Wiring diagram for counter input

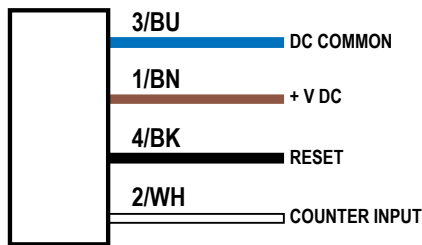
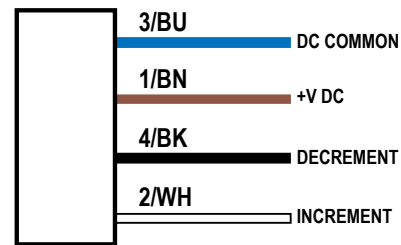

Figure 33. Wiring diagram for counter increment-decrement



¹⁰ Threshold markers only apply to WLS15 Pro devices.

4.5.5 Application: Distance

The distance mode uses the light to display colored LEDs proportional to a PFM (pulse frequency modulation) or PWM (pulse width modulation) input. Four thresholds are available to change color, flashing, and intensity as the input value changes.

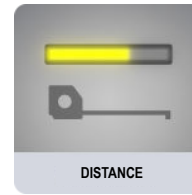

Basic Distance

The distance option controls the color and position of the LEDs based on a defined PFM or PWM input range. The PFM signal frequency range can be from 100 to 10,000 Hz. The PWM duty cycle range can be from 0 to 100%. The light adjusts position and color continuously based on the input value and defined color, flash, and intensity in up to four thresholds. Threshold markers ¹¹ can be applied, from which color and intensity can also be defined.



Figure 34. Basic distance settings

PWM/PFM: PFM PFM Low: 100 PFM High: 600

Dominance: Disabled Threshold Marker: Dominant Marker color: Pink Marker Intensity: High

Presets: Standard Settings

Threshold	Enabled	Percent	Flash	Color	Intensity	Speed	Pattern
#4 - Top:	<input checked="" type="checkbox"/>	100	<input type="checkbox"/>	Red	High	Standard	Normal
#3:	<input checked="" type="checkbox"/>	75	<input type="checkbox"/>	Yellow	High	Standard	Normal
#2:	<input checked="" type="checkbox"/>	50	<input type="checkbox"/>	Blue	High	Standard	Normal
#1 - Connector:	<input checked="" type="checkbox"/>	25	<input type="checkbox"/>	Green	High	Standard	Normal

Read Write Wiring Diagram

Distance with Background

The distance option controls the color and position of the LEDs based on a defined PFM or PWM input range. The PFM signal frequency range can be from 100 to 10,000 Hz. The PWM duty cycle range can be from 0 to 100%. The light adjusts position and color continuously based on the input value and defined color, flash, and intensity in up to four thresholds while maintaining a steady background for LEDs outside the active threshold range. A steady global background or threshold markers ¹¹ can be applied, from which color and intensity can be defined.

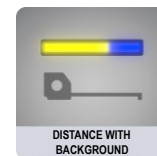

¹¹ Threshold markers only apply to WLS15 Pro devices.

Figure 35. Distance with background settings

PWM/PFM: PFM PFM Low: 100 PFM High: 600

Background color: Background intensity: Off Dominance: Disabled Threshold Marker: Dominant Marker color: Marker Intensity: High

Presets: Standard Settings

Threshold	Enabled	Percent	Flash	Color	Intensity	Speed	Pattern
#4 - Top:	<input checked="" type="checkbox"/>	100	<input type="checkbox"/>	Red	High	Standard	Normal
#3:	<input checked="" type="checkbox"/>	75	<input type="checkbox"/>	Yellow	High	Standard	Normal
#2:	<input checked="" type="checkbox"/>	50	<input type="checkbox"/>	Blue	High	Standard	Normal
#1 - Connector:	<input checked="" type="checkbox"/>	25	<input type="checkbox"/>	Green	High	Standard	Normal

Read Write Wiring Diagram

Figure 36. Wiring diagram for distance

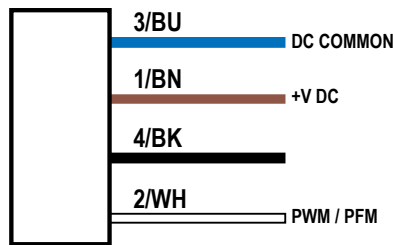

Coarse Distance

Choose colors, intensities, and flash patterns to create up to seven discretely controlled levels based on input wiring logic states for simple distance and level indication.



Figure 37. Coarse distance settings

Number of Levels: 7 Level Background Color: Background Intensity: Off Direction: ↑

Presets: Standard Settings

Level	Input Wire	Flash	Color	Intensity	Speed	Pattern
#1 - (Connector)	Brown(Pin 1):	<input type="checkbox"/>	Green	High	Standard	Normal
#2	Black(Pin 4):	<input type="checkbox"/>	Green	High	Standard	Normal
#3	White(Pin 2):	<input type="checkbox"/>	Yellow	High	Standard	Normal
#4	Brown/Black:	<input type="checkbox"/>	Yellow	High	Standard	Normal
#5	Brown/White:	<input type="checkbox"/>	Yellow	High	Standard	Normal
#6	Black/White:	<input type="checkbox"/>	Red	High	Standard	Normal
#7 - (Top)	All:	<input type="checkbox"/>	Red	High	Standard	Normal

Read Write

4.5.6 Application: Gauge

The gauge mode uses the light to display a colored band of LEDs in a position proportional to a PFM or PWM input. Upper, lower, and center thresholds are available to change color, animation, and intensity as the input signal changes. The width of the band is configurable.

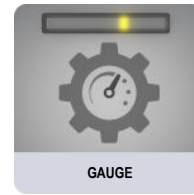

Basic Gauge

The gauge option controls the color and position of a band of LEDs based on a defined PFM or PWM input range. The PFM signal frequency range can be from 100 to 10,000 Hz. The PWM duty cycle range can be from 0 to 100%. The width of the band is defined as a percentage of total lighted length. The light adjusts the position and color of the band continuously based on the input signal and defined color, flash, intensities, and animations in upper, lower, and center thresholds. Threshold markers¹² can be applied, from which color and intensity can also be defined.



Figure 38. Basic gauge settings

PWM/PFM:	PFM	PFM Low:	100	PFM High:	600
Band Size Percentage:	20	Threshold Marker:	Dominant	Marker color:	Pink
				Marker Intensity:	High
Presets: Standard Settings					
Threshold	Enabled	Percent	Animation	Colors	Intensities
				Color 1	Color 2
Upper - Top:	<input checked="" type="checkbox"/>	80	Steady	Red	High
Center:	<input type="checkbox"/>		Steady	Green	High
Lower - Connector:	<input checked="" type="checkbox"/>	20	Steady	Red	High
					Speed
					Standard
					Normal
					Standard
					Normal
					Standard
					Normal
<input type="button" value="Read"/> <input type="button" value="Write"/> <input type="button" value="Wiring Diagram"/>					

Gauge with Background

The gauge option controls the color and position of a band of LEDs based on a defined PFM or PWM input range. The PFM signal frequency range can be from 100 to 10,000 Hz. The PWM duty cycle range can be from 0 to 100%. The width of the band is defined as a percentage of total lighted length. The light adjusts the position and color of the band and background continuously based on the input signal and defined color, flash, intensities, and animations in upper, lower, and center thresholds. A steady global background or threshold markers¹² can be applied, from which color and intensity can be defined.



¹² Threshold markers only apply to WLS15 Pro devices.

Figure 39. Gauge with background settings

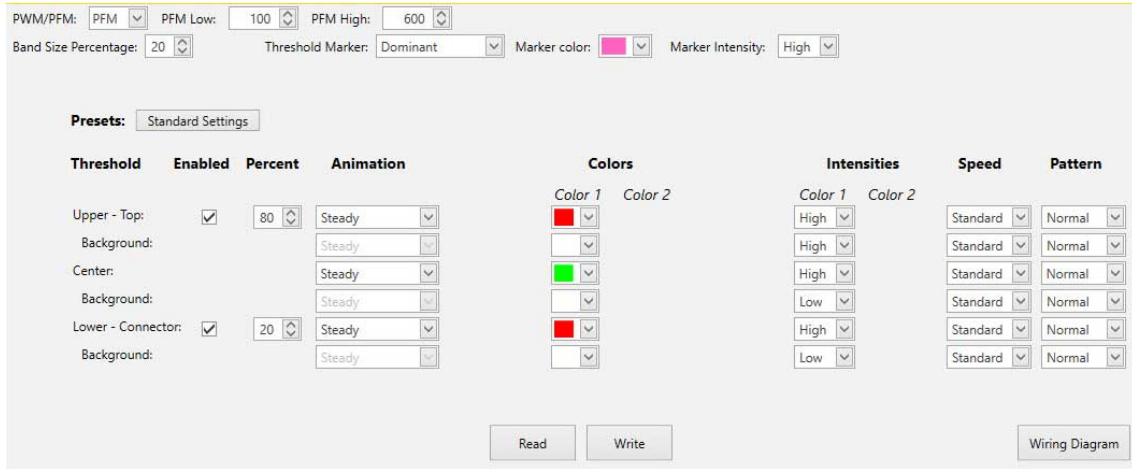
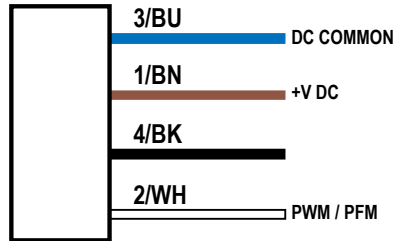
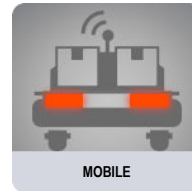

Figure 40. Wiring diagram for gauge



4.5.7 Application: Mobile

Choose colors and animations to create states that can be used for advanced and intuitive indication on mobile equipment.



Basic Warning

Choose colors, intensities, and animations to create a discretely controlled, three segment indicator for the communication of equipment status. The segments are controlled independently with input wires.



Figure 41. Basic warning settings

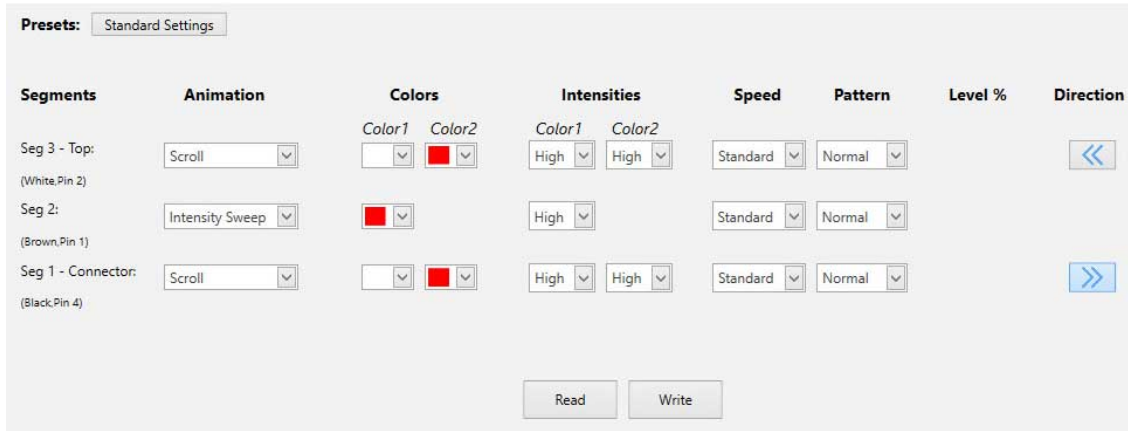

Advanced Warning

Create up to seven discretely controlled status indicators, and use presets for Loading and Emergency Stop conditions. Colors, animations, speeds, and intensities provide equipment status.

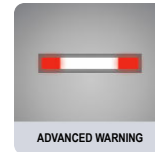
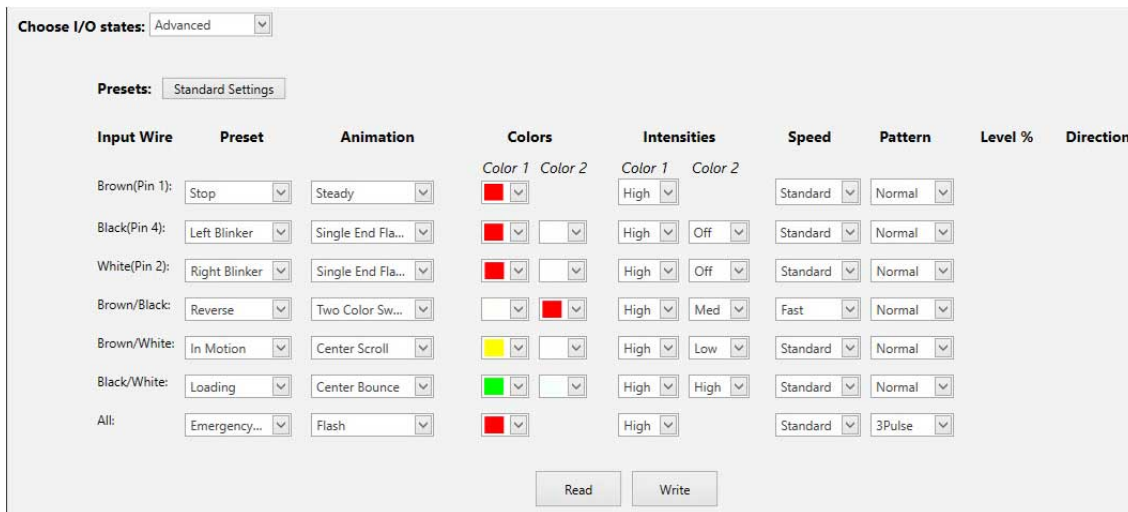

Figure 42. Advanced warning settings



4.5.8 Application: Pick Put Build

Choose colors and animations to create states that can be used to guide operators, signal material status, enable light-guided assembly, create pick-to-light operations, and enable kitting operations.



Basic Segment

Choose colors, intensities, and animations to create a discretely controlled, two or three segment indicator for the communication of processes.

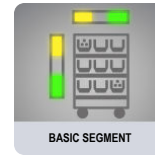

Figure 43. Basic segment settings

Segment Mode: 3 Segment | Background Color: | Background Intensity: Off

Presets: Standard Settings

Segment	Animation	Colors		Intensities		Speed	Pattern	Level %	Direction
		Color1	Color2	Color1	Color2				
Segment 3: <i>(White, Pin 2)</i>	Intensity Sweep	■		High		Standard	Normal		
Segment 2: <i>(Brown, Pin 1)</i>	Intensity Sweep	■		High		Standard	Normal		
Segment 1: <i>(Black, Pin 4)</i>	Intensity Sweep	■		High		Standard	Normal		

Read Write

Advanced Segment

Enable up to seven discretely controlled segments to be used as individual indication states. Only one segment can be enabled at once.

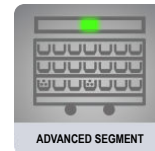

Figure 44. Advanced segment settings

Segment Mode: 7 Segment | Background Color: | Background Intensity: Off

Presets: Standard Settings

Segment	Wire	Animation	Colors		Intensities		Speed	Pattern	Level %	Direction
			Color1	Color2	Color1	Color 2				
Segment 1:	Brown(Pin 1):	Intensity Sweep	■		High		Standard	Normal		
Segment 2:	Black(Pin 4):	Intensity Sweep	■		High		Standard	Normal		
Segment 3:	White(Pin 2):	Intensity Sweep	■		High		Standard	Normal		
Segment 4:	Brown/Black:	Intensity Sweep	■		High		Standard	Normal		
Segment 5:	Brown/White:	Intensity Sweep	■		High		Standard	Normal		
Segment 6:	Black/White:	Intensity Sweep	■		High		Standard	Normal		
Segment 7:	All:	Intensity Sweep	■		High		Standard	Normal		

Read Write

4.6 Read Device Settings

To read the settings of the connected device, click **Read Device Settings**. Upon successful completion, the message "Device Read Success" displays momentarily. Pro Editor populates the settings of the connected device.

4.7 Write Device Settings

To write settings to a device, select **Write Device Settings**. Once successful, the message "Device Write Success" appears momentarily. The connected device is ready for use.

4.8 Connected Device Information

The model number and firmware information of the connected device is shown at the bottom of the screen.

4.9 Device Connection Status and Software Update Notification

Status	Description
Connected	A Pro Series-enabled device is connected to the Pro Editor software.
Not Connected	A Pro Series-enabled device is not connected to the Pro Editor software.
	When connected to a network, if a Pro Editor software update is available, a red icon displays in the bottom right corner of Pro Editor. To update Pro Editor, click on the notification icon and click Upgrade when prompted. Pro Editor closes, and an installer is downloaded to the desktop on your computer. Double-click the installer to begin the update.

5 Configure a Device

Read, write, and preview device states using the following controls.



Note: After editing a device state setting or loading a configuration file, any settings that are not written to the connected device are highlighted yellow. Disconnecting the device from Pro Editor before writing device settings will result in these settings being lost.

5.1 Preview

To preview a device state, click **Start** on the desired device function row. The selected row remains available for editing while all other rows are locked and shown as grayed out. If any options are changed during this time they are highlighted yellow while all other rows and the **File** and **Device** menu items are locked ¹³.

Figure 45. Pro Editor Configuration – Preview Active

Preview	Device State	Animation	Color 1	Intensity 1	Color 2	Intensity 2	Speed	Pattern	Direction	Audible
Start	Black Wire (Pin 4)	Steady	Red	Hi						Off
Stop	Brown Wire (Pin 1)	50/50	Green	Hi	Red	Med				Off
Start	White Wire (Pin 2)	Steady	Blue	Hi						Off
Start	Gray Wire (Pin 5)	Demo								

Read Device Settings Write Device Settings



To stop preview, click **Stop**. Any device state options that were changed will remain but are not written to the device unless **Write Device Settings** is clicked. In segment mode, multiple tower light device states can be previewed at once. For all other devices and modes, only one state can be previewed at a time.



Note: By default, when not in preview mode, a connected 5-pin indicator device displays the configured Brown and Gray Device State function. An 8-pin indicator device displays the configured Brown and Yellow Device State functions.



Note: If using the limited preview capabilities setup, some preview features may be unavailable, including certain animations and colors.



Note: If using the limited preview capabilities setup, a red flashing LED on the Pro Converter Cable indicates a device power fault. See [Troubleshooting](#) on p. 40 for more information.



Note: The preview function is not currently available for the WLS27 Pro or the WLS15 Pro.

5.2 Tower Light Advanced Mode Preview

Tower Light Advanced Mode includes a preview function which can be used to preview the threshold conditions on the tower light. Click start to begin the preview and use the vertical scroll bar to view the defined thresholds.

¹³ When applicable, the **File**, **Device**, **Global Parameters**, and **Advanced Settings** items are disabled when a device is in Preview Mode.

Figure 46. Advanced Mode Preview for the TL50 Pro Tower Lights

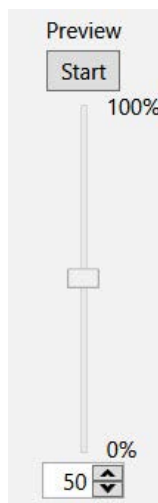

5.3 Device State

The **Device State** table lists the animation configurations which can be activated by input wires. The listed wire color(s) must be ON for the device state to display.



Note: For indicator and tower light devices, the blue or brown wire should always be connected to ground, depending on desired polarity.



Note: For touch devices, the blue and brown wires should always be connected to power and ground, depending on desired polarity.



Note: For touch devices in Four State Full Logic mode, wire colors are replaced with state numbers corresponding to the active logic mode.

5.4 Animation

One animation can be configured for each wire status. Some animations have additional options available once selected. For example, if the 50/50 rotate animation is selected the Color 1, Intensity 1, Color 2, Intensity 2, Speed, and Direction controls become available. The following are the animation settings for the K30, K50, K90, and S22 models.

Animation	Description
Off	Device OFF, no animation displays
Steady	Color 1 is solid ON at the defined intensity
Flash	Color 1 flashes at the defined speed, color intensity, and pattern (normal, strobe, three pulse, SOS, or random)
Two Color Flash	Color 1 and Color 2 flash alternately at the defined speed, color intensities, and pattern (normal, strobe, three pulse, SOS, or random)
50/50	Color 1 displays ON 50% and Color 2 displays ON the other 50% statically at the defined color intensities
50/50 Rotate	Color 1 displays ON 50% and Color 2 displays ON the other 50% while rotating at the defined speed, color intensities, rotational direction
Chase	Color 1 displays as a single spot against the background of Color 2 while rotating at the defined speed, color intensities, rotational direction
Intensity Sweep	Color 1 repeatedly increases and decreases intensity between 0% and the defined intensity at the defined speed
Demo	Cycles through discrete and continuous color spectrums

The following are the animation settings for the tower light models, which are controlled by segment.

Segment Mode Animation	Description
Off	Segment is off
Steady	Color 1 is on at defined intensity
Flash	Color 1 flashes at defined speed, color intensity, and pattern (normal, strobe, three pulse, SOS, or random)
Two Color Flash	Color 1 and Color 2 flash alternately at defined speed, color intensities, and pattern (normal, strobe, three pulse, SOS, or random)
50/50	Color 1 is displayed on 50% of the segment and Color 2 is displayed on the other 50% of the segment at the defined color intensities
50/50 Rotate	Color 1 is displayed on 50% of the segment and Color 2 is displayed on the other 50% of the segment while rotating at the defined speed, color intensities, and rotational direction
Chase	Color 1 is displayed as a single spot against the background of Color 2 while rotating at the defined speed, color intensities, and rotational direction
Intensity Sweep	Color 1 repeatedly increases and decreases intensity between 0% to 100% at defined speed and color intensity

The Run Mode animation settings are available for tower light devices and control the entire tower light. These animations can also be accessed with the Action Input.

Run or Action Mode Animation	Description
Off	All tower light segments are off
Steady	Color 1 is solid on for every tower light segment at defined intensity
Flash	Color 1 flashes on every tower light segment at defined speed, color intensity, and pattern (normal, strobe, three pulse, SOS, or random)
Two Color Flash	Color 1 and Color 2 flash alternately on every segment at defined speed, color intensities, and pattern (normal, strobe, three pulse, SOS, or random)
50/50	Color 1 is displayed on 50% of every segment and Color 2 is displayed on the other 50% of every segment at the defined color intensities and segment shift
50/50 Rotate	Color 1 is displayed on 50% of every segment and Color 2 is displayed on the other 50% of every segment while rotating at the defined speed, color intensities, rotational direction, and segment shift
Chase	Color 1 is displayed as a single spot against the background of Color 2 while rotating at the defined speed, color intensities, rotational direction, and segment shift
Intensity Sweep	Color 1 repeatedly increases and decreases intensity between 0% to 100% on every segment at defined speed and color intensity
Scroll	Color 1 fills two segments and those segments move in one direction up or down against the background of Color 2 at the defined speed, color intensities, and rotational direction
Bounce	Color 1 fills two segments and those segments move up and down between the top and bottom of the tower against the background of Color 2 at the defined speed, color intensities, and rotational direction
Color Spectrum	The tower light scrolls through the 14 predefined colors with a different color on each segment at the defined speed, Color 1 intensity, and rotational direction

The following are the animation settings for the WLS27 Pro and WLS15 Pro models.

Animation	Description
Off	Device OFF, no animation displays
Steady	Color 1 is solid ON at the defined intensity
Flash	Color 1 flashes at the defined speed, color intensity, and pattern (normal, strobe, three pulse, SOS, or random)
Two Color Flash	Color 1 and Color 2 flash alternately at the defined speed, color intensities, and pattern (normal, strobe, three pulse, SOS, or random)
Two Color Shift	Color 1 and Color 2 flash alternately on adjacent LEDs at defined speed and color intensities

Animation	Description
Ends Steady	Color 1 defines the center 75% of the light. Color 2 defines the 12.5% of the light on each end. Center and ends are on steady. Center proportion can be defined in End Status mode
Ends Flash	Color 1 defines the center 75% of the light. Color 2 defines the 12.5% of the light on each end. The ends will flash at defined speed and pattern. Center proportion can be defined in End Status mode
Scroll	Color 1 defines a band 20% of the length of the light that moves in one direction up or down against the background of Color 2 at the defined speed and color intensities
Center Scroll	Color 1 defines a band 10% the length of the light that moves from the center of the light to the ends against the background of Color 2 at the defined speed and color intensity
Bounce	Color 1 defines a band 20% of the length of the light that moves up and down between the top and bottom of the light against the background of Color 2 at the defined speed and color intensities
Center Bounce	Color 1 defines a band 10% the length of the light that moves from the center of the light to the ends and back against the background of Color 2 at the defined speed and color intensity
Intensity Sweep	Color 1 continuously increases and decreases intensity between 0% to 100% at defined speed and color intensity
Two Color Sweep	Color 1 and Color 2 define the end values of a line across the color gamut. The light continuously displays a color by moving along the line at the defined speed and color intensity
Color Spectrum	The light scrolls through the 13 predefined colors with a different color on each LED at the defined speed, Color 1 intensity, and direction
Single End Steady (WLS15 Pro only)	Color 1 is solid ON at the defined intensity on one end of the device
Single End Flash (WLS15 Pro only)	Color 1 flashes at the defined speed, color intensity, and pattern (normal, strobe, three pulse, SOS, or random) on one end of the device

5.5 Color 1 or Color 2

The following colors are available for Color 1 and Color 2. ¹⁴

- Red
- Green
- Yellow
- Blue
- Magenta
- Cyan
- White
- Amber
- Rose
- Lime Green
- Orange
- Sky Blue
- Violet
- Spring Green
- Neutral White (5700K) ¹⁵
- Warm White (3000K) ¹⁵
- Fluorescent White (4100K) ¹⁵
- Daylight White (5000K) ¹⁵
- Incandescent White (2700K) ¹⁵
- Cool White (6500K) ¹⁵

5.6 Intensity 1 or Intensity 2

The Intensity control sets the intensity of a color. Color 1 is controlled by Intensity 1. Color 2, if applicable, is controlled by Intensity 2.

Intensity	Indicator, Touch, and Tower Light Devices	Strip Light Devices
Hi	100%	100%
Med	60%	50%
Low	25%	20%
Off	0%	0%

¹⁴ The following colors are uncalibrated to achieve higher saturation: Red, Green, and Blue. They may show greater variance between devices than other colors.

¹⁵ Only available on WLS27 Pro and WLS15 Pro.

5.7 Speed

The Speed control sets the speed of five animation options: flash, chase, rotate, scroll, and bounce.

Flash, Scroll, and Bounce Animation Speed

Speed	Description
Slow	0.5 Hz
Standard	1 Hz
Fast	5 Hz

Rotational and Chase Animation Speed

Speed	Description
Slow	1 Hz
Standard	2 Hz
Fast	4Hz

5.8 Pattern

The Pattern control sets the pattern of the flash animation.

Pattern	Description
Normal	Alternating Color 1; Color 2 at 50% duty cycle
Strobe	Continuous Color 1; Color 2 flashes at 20% duty cycle
3-Pulse	Three consecutive Color 1 pulses at 10% duty cycle on Color 2 background
SOS	Short pulse, short pulse, short pulse, long pulse, long pulse, long pulse, short pulse, short pulse, short pulse alternating Color 1 and Color 2
Random	Random sequence of light signals

5.9 Direction

The Direction control sets the direction of the animation.

Direction	Description
Clockwise (CW)	Animation rotates in clockwise direction. Applies to 50/50 rotate and chase.
Counterclockwise (CCW)	Animation rotates in counterclockwise direction. Applies to 50/50 rotate and chase.
Up	Animation originates from the connector end
Down	Animation originates from the non-connector end

5.10 Shift Enable

Shift enable controls the 50/50, 50/50 Rotate, and Chase animations in Run and Action Mode. When applied, the shift enable consecutively offsets each segment animation by one LED.

5.11 Audible

The Audible control sets Audible options.



Note: Only available with Pro Series-enabled audible devices.

Audible	Description
Off	OFF
Steady	Constant tone
Pulsed	ON/OFF tone at 50% duty cycle
SOS	Short tone, short tone, short tone, long tone, long tone, long tone, short tone, short tone, short tone

5.12 Vibration

The Vibration control sets Vibration options.



Note: Only available with Pro Series-enabled vibration feedback devices.

The vibration is contingent on touch and has a maximum total on-time per touch of 3 seconds.

In Four State Full Logic mode, Vibration can only be defined for States 3 and 4 in which the touch conditions occur. In Three State and Seven State Advanced Control, the vibration can be defined for any state and is contingent on both the input(s) and a touch condition.

Vibration	Description
Off	No vibration on touch
On	Steady vibration on touch
Pattern	Only available if Animation is defined as Flash or Two Color Flash. The vibration follows the defined animation Pattern (Normal, Strobe, 3-Pulse, SOS, Random) and animation Speed (Slow, Standard, Fast).

6 Troubleshooting

6.1 Pro Editor Error Messages

Error Message	Recommended Solution
Found device (#) with Firmware ID/Version (##), which does not match the selected device (#) with Firmware ID/version (##). Advanced Settings fields have not been updated. Please contact the manufacturer for device updates.	The detected device has outdated firmware. Connect a different device or contact Banner support regarding firmware updates.
Error reading device information. Unable to update Advanced Settings fields.	Autodetect failed to read the device settings. Try again or attempt to connect with manual settings. If the error persists, contact Banner support regarding firmware updates.
No device found. Please check your USB connection or try a different COM Port.	Autodetect did not find any devices on the specified COM port. Ensure the Device Type and COM Port selections are correct, and that the device is properly connected and powered.
Connection failed: No connector box was detected on the selected port.	No Banner Pro Series-enabled device found on the specified COM port. Ensure the COM Port selection is correct, and that the device is properly connected and powered (if applicable).
Device (#) with Firmware ID (#) does not match the selected device (#) with Firmware ID (#). Please select the correct device or contact the manufacturer for updates.	Ensure that the correct Device Type is selected and attempt to connect again. If the error persists, contact Banner support regarding firmware updates.
Device (#) with Firmware version (#) does not match the selected device (#) with Firmware version (#). Please select the correct device or contact the manufacturer for updates.	Ensure that the correct Device Type is selected and attempt to connect again. If the error persists, contact Banner support regarding firmware updates.
Connection failed: Window was manually closed during connection attempt.	Open the Connection dialog and re-configure your connection. Do not close the Connection dialog while a connection attempt is in progress.
Connection failed: Unable to read device model and firmware info.	Try to connect again. If the error persists, contact Banner support regarding firmware updates.
Connection failed: Device was not detected. Please check the wired connection.	Verify that the device is properly connected and powered, and ensure the connection settings are correct.
Checksum mismatch: This file contains a bad checksum. It was either modified outside of Pro Editor or created by an earlier version of Pro Editor. Would you like to open the file anyway? If it's a valid file, re-saving it once it's opened will repair its checksum.	If the configuration file was created by an earlier version of Pro Editor, click yes and re-save the file to update the checksum. If the file may have been changed manually, click no to avoid loading bad configuration parameters.

6.2 Pro Converter Cable Error

LED Behavior	Error	Recommended Solution
Fast flashing red (10 Hz)	Device Power Fault	Connect the device using the recommended full preview capabilities setup. To continue using the limited preview capabilities setup, disconnect the cable and reconnect the device to the PC. If error persists, contact Banner support.

7 Accessories

7.1 Pro Editor Hardware

PRO-KIT

Includes:

- Pro Converter Cable (MQDC-506-USB)
- Splitter (CSB-M1251FM1251M)
- Power Supply (PSW-24-1)

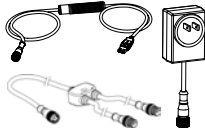

PRO-KIT-K50

Includes:

- Pro Series-enabled K50 (K50L2RGB7Q)
- Pro Converter Cable (MQDC-506-USB)
- Splitter (CSB-M1251FM1251M)
- Power Supply (PSW-24-1)



PRO-KIT-ACC

Includes:

- Pro Converter Cable (MQDC-506-USB)
- Splitter (CSBM1251FM1251M)
- Power Supply (PSW-24-1)
- 8-pin to 5-pin double-ended cordset (MQDC-801-5M-PRO)
- Mating accessory for cabled and terminal models (ACC-PRO-CABLE5)

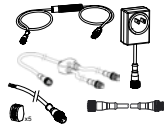

ACC-PRO-CABLE5

- Mating accessory for cabled and terminal models
- 150 mm (6 inch) PVC cable with M12 quick disconnect
- Lever wire nuts included (qty 5)
- Required to connect cabled models to Pro Converter Cable, sold separately

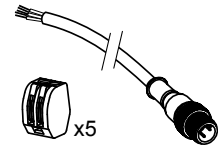

MQDC-506-USB

- Pro Converter Cable
- 1.83 m (6 ft) M12 quick disconnect to Device and USB to PC
- Required for connection to Pro Editor

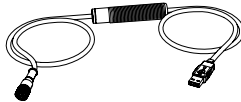

CSB-M1251FM1251M

- 5-pin parallel Y splitter (Male-Male-Female)
- For full Pro Editor preview capability
- Requires external power supply, sold separately

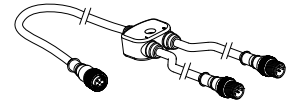

PSW-24-1

- 24 V DC, 1 A power supply
- 2 m (6.5 ft) PVC cable with M12 quick disconnect
- Provides external power with splitter cable, sold separately

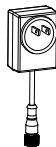

MQDC-801-5M-PRO

- 8-pin to 5-pin double-ended cordset
- 0.31 m (1 ft) PVC cable with M12 quick disconnects
- Required to connect 8-pin Pro Series-enabled devices to Pro Converter Cable (MQDC-506-USB), sold separately



PSD-24-4

- 90 to 264 V AC 50/60 Hz input
- Includes a 1.8 m (6 ft) US style 5-15P input plug
- 24 V DC UL Listed Class 2 M12 connector output
- 4 A total current



LC28PB2-3Q

- In-line switch with M12 connectors
- Rugged metal housing
- Perfect for dc-powered task lights, indicators, and tower lights
- Rated for up to 30 V dc

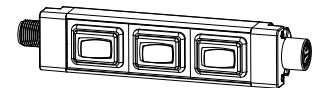

8 Product Support and Maintenance

8.1 Maintenance

Maintenance tasks include updating the Pro Editor software as new versions become available.

8.1.1 Update the Software

The current version of the Pro Editor software is available for download from www.bannerengineering.com/proeditor.

When connected to a network, if a Pro Editor software update is available, a red icon  displays in the bottom right corner of Pro Editor. See [Device Connection Status and Software Update Notification](#) on p. 33 for more information.

8.2 Pro Editor Release Notes

Version	Devices	General
1.5	Added support for S22 Pro Touch Added support for S22 Pro Indicator Replaced Open Factory Default File option in File menu with Restore Device Factory Configuration command Added  Help button next to Choose I/O states drop-down for indicator devices Indicator devices now default to Advanced I/O state when connected Added tooltips for Read Device Settings and Write Device Settings buttons	Connection Window—Device type is now auto-detected when connecting a device. Scan for Device functionality in Advanced Settings can now scan for all supported device types at once. Comm Port selection is remembered when the Connection window is opened within a Pro Editor session. General—New Config file format saves I/O state parameter and reduces file size; users are prompted to re-save their existing files on load to upgrade to new format
1.7	Added support for K50 Pro Touch Added AdvancedSettings menu for K50 Pro Touch devices Added Device menu Moved Open Legacy Default Template and Restore Device Factory Configuration commands from File menu to new Device menu	Updated config file checksum to ignore comments; opening an existing config file in Pro Editor and re-saving it will update it to the new checksum format Added Sentry integration to automatically report crash data and usage statistics; for more information see the README.txt file located in the Pro Editor installation directory
1.8	Added support for TL50 Pro	Changed connection screen
1.9	Added support for vibration-enabled K50 Pro Touch devices	--
2.2	Added support for WLS27 Pro	--
2.3	Added support for WLS15 Pro, K90 Pro, and K50 Pro Beacon	--

8.3 Contact Us

Banner Engineering Corp. headquarters is located at:

9714 Tenth Avenue North
 Minneapolis, MN 55441, USA
 Phone: + 1 888 373 6767

For worldwide locations and local representatives, visit www.bannerengineering.com.

8.4 Banner Engineering Corp. Limited Warranty

Banner Engineering Corp. warrants its products to be free from defects in material and workmanship for one year following the date of shipment. Banner Engineering Corp. will repair or replace, free of charge, any product of its manufacture which, at the time it is returned to the factory, is found to have been defective during the warranty period. This warranty does not cover damage or liability for misuse, abuse, or the improper application or installation of the Banner product.

THIS LIMITED WARRANTY IS EXCLUSIVE AND IN LIEU OF ALL OTHER WARRANTIES WHETHER EXPRESS OR IMPLIED (INCLUDING, WITHOUT LIMITATION, ANY WARRANTY OF MERCHANTABILITY OR FITNESS FOR A PARTICULAR PURPOSE), AND WHETHER ARISING UNDER COURSE OF PERFORMANCE, COURSE OF DEALING OR TRADE USAGE.

This Warranty is exclusive and limited to repair or, at the discretion of Banner Engineering Corp., replacement. **IN NO EVENT SHALL BANNER ENGINEERING CORP. BE LIABLE TO BUYER OR ANY OTHER PERSON OR ENTITY FOR ANY EXTRA COSTS, EXPENSES, LOSSES, LOSS OF PROFITS, OR ANY INCIDENTAL, CONSEQUENTIAL OR SPECIAL DAMAGES RESULTING FROM ANY PRODUCT DEFECT OR FROM THE USE OR INABILITY TO USE THE PRODUCT, WHETHER ARISING IN CONTRACT OR WARRANTY, STATUTE, TORT, STRICT LIABILITY, NEGLIGENCE, OR OTHERWISE.**

Banner Engineering Corp. reserves the right to change, modify or improve the design of the product without assuming any obligations or liabilities relating to any product previously manufactured by Banner Engineering Corp. Any misuse, abuse, or improper application or installation of this product or use of the product for personal protection applications when the product is identified as not intended for such purposes will void the product warranty. Any modifications to this product without prior express approval by Banner Engineering Corp will void the product warranties. All specifications published in this document are subject to change; Banner reserves the right to modify product specifications or update documentation at any time. Specifications and product information in English supersede that which is provided in any other language. For the most recent version of any documentation, refer to: www.bannerengineering.com.

For patent information, see www.bannerengineering.com/patents.

8.5 FCC Part 15 and CAN ICES-3 (B)/NMB-3(B)

This device complies with part 15 of the FCC Rules and CAN ICES-3 (B)/NMB-3(B). Operation is subject to the following two conditions:

1. This device may not cause harmful interference, and
2. This device must accept any interference received, including interference that may cause undesired operation.

This equipment has been tested and found to comply with the limits for a Class B digital device, pursuant to part 15 of the FCC Rules and CAN ICES-3 (B)/NMB-3(B). These limits are designed to provide reasonable protection against harmful interference in a residential installation. This equipment generates, uses and can radiate radio frequency energy and, if not installed and used in accordance with the instructions, may cause harmful interference to radio communications. However, there is no guarantee that interference will not occur in a particular installation. If this equipment does cause harmful interference to radio or television reception, which can be determined by turning the equipment off and on, the user is encouraged to try to correct the interference by one or more of the following measures:

- Reorient or relocate the receiving antenna.
- Increase the separation between the equipment and receiver.
- Connect the equipment into an outlet on a circuit different from that to which the receiver is connected.
- Consult the manufacturer.