

High Speed Translator Buffer to PECL

FEATURES

- Input clock frequency ≤ 266 MHz
- JEDEC standard Differential LVPECL output
- 70mA typical power supply current
- 300ps Max. Rise/Fall time
- 740ps input propagation delay
- LVC MOS and LVTTTL Input compatible
- Single 2.5V $\pm 5\%$ or 3.3V $\pm 10\%$ power supply with $V_{EE}=0V$
- Available in 8 pin SOP Green/RoHS compliant Package

PIN CONFIGURATION

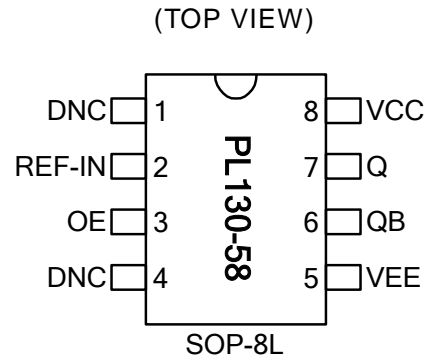

DESCRIPTION

The PL130-58 is a low cost, high performance, high speed, translator buffer that produces a pair of differential LVPECL outputs from CMOS input. Outputs are JEDEC standard LVPECL signals.

The device is targeted for Backplane buffering, data distribution, Fibre Channel and many other applications.

BLOCK DIAGRAM

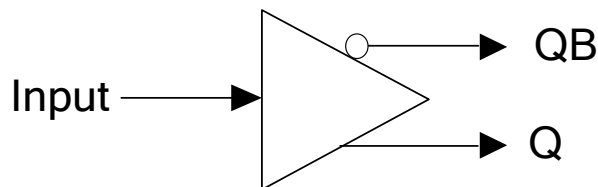

High Speed Translator Buffer to PECL
PIN DESCRIPTIONS

| Name | SOP-8L | Type | Description |
|--------|--------|--------|--|
| DNC | 1, 4 | - | Do Not Connect |
| REF-IN | 2 | Input | Reference input signal. The frequency of this signal will be reproduced at the output (after translation to PECL level). |
| OE | 3 | Input | Output enable ('1' for enable). Internal pull-up (default is '1'). |
| VEE | 5 | Power | Power Ground. |
| QB | 6 | Output | PECL Complementary output. |
| Q | 7 | Output | PECL True output. |
| VCC | 8 | Power | Positive Power Supply. |

ELECTRICAL SPECIFICATIONS
1. Absolute Maximum Ratings

| PARAMETERS | SYMBOL | MIN. | MAX. | UNITS |
|-----------------------------------|----------|------|--------------|-------|
| Supply Voltage | V_{DD} | | 4.6 | V |
| Input Voltage, dc | V_I | -0.5 | $V_{DD}+0.5$ | V |
| Output Voltage, dc | V_O | -0.5 | $V_{DD}+0.5$ | V |
| Storage Temperature | T_S | -65 | 150 | °C |
| Ambient Operating Temperature* | T_A | -40 | 85 | °C |
| Junction Temperature | T_J | | 110 | °C |
| Lead Temperature (soldering, 10s) | | | 260 | °C |

Exposure of the device under conditions beyond the limits specified by Maximum Ratings for extended periods may cause permanent damage to the device and affect product reliability. These conditions represent a stress rating only, and functional operations of the device at these or any other conditions above the operational limits noted in this specification is not implied.

* **Note:** Operating Temperature is guaranteed by design for all parts (COMMERCIAL and INDUSTRIAL), but tested for COMMERCIAL grade only.

2. AC Specifications

| PARAMETERS | CONDITIONS | MIN. | TYP. | MAX. | UNITS |
|------------------|------------|------|------|------|-------|
| Input Frequency | | | | 266 | MHz |
| Output Frequency | | | | 266 | MHz |

High Speed Translator Buffer to PECL

6. PECL Switching Characteristics

| PARAMETERS | SYMBOL | CONDITIONS | MIN. | TYP. | MAX. | UNITS |
|-----------------|--------|----------------------------|------|------|------|-------|
| Clock Rise Time | t_r | @20/80% of output waveform | | | 300 | ps |
| Clock Fall Time | t_f | @80/20% of output waveform | | | 300 | ps |

PECL Levels Test Circuit

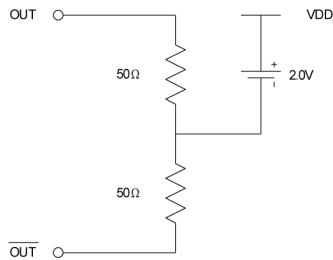

PECL Output Skew

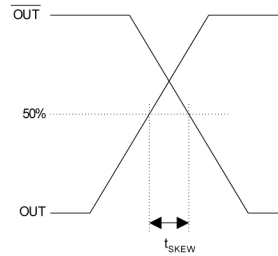

PECL Transition Time Waveform

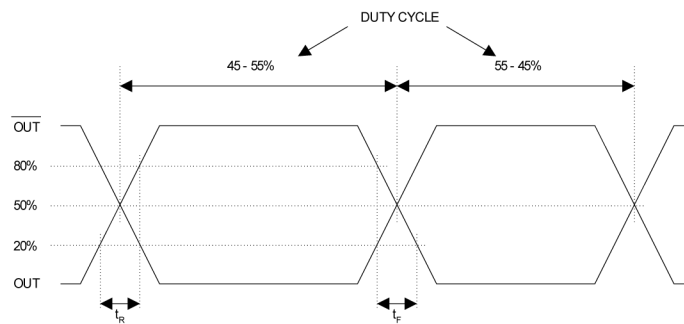

High Speed Translator Buffer to PECL

PACKAGE INFORMATION (GREEN PACKAGE COMPLIANT)

8 PIN (dimensions in mm)

| SOP-8L | | |
|--------|----------|------|
| Symbol | Min. | Max. |
| A | 1.47 | 1.73 |
| A1 | 0.10 | 0.25 |
| B | 0.33 | 0.51 |
| C | 0.19 | 0.25 |
| D | 4.80 | 4.95 |
| E | 3.80 | 4.00 |
| H | 5.80 | 6.20 |
| L | 0.38 | 1.27 |
| e | 1.27 BSC | |

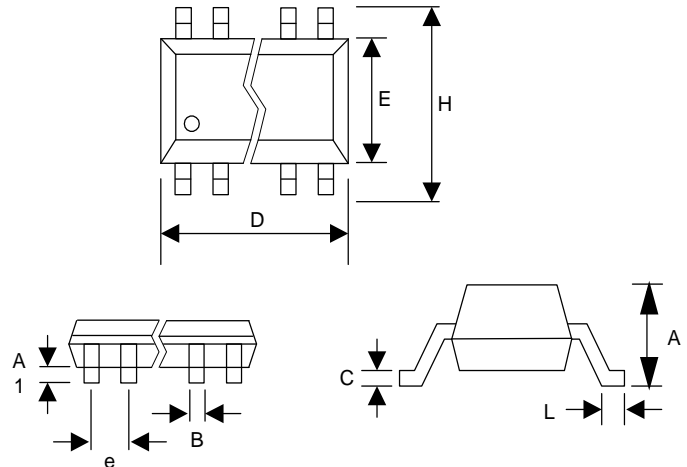

ORDERING INFORMATION

For part ordering, please contact our Sales Department:

2180 Fortune Drive, San Jose, CA 95131, USA

Tel: (408) 944-0800 Fax: (408) 474-1000

PART NUMBER

The order number for this device is a combination of the following:
Part number, Package type and Operating temperature range

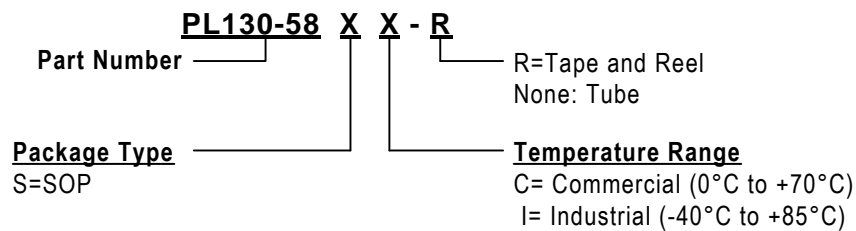

| Order Number | Marking | Package Option |
|--------------|-------------|------------------------|
| PL130-58SC-R | P130-58 | SOP-8L - Tape and Reel |
| PL130-58SC | SC LLLLL | SOP-8L - Tube |

*Note: LLLLL designates lot number

Micrel Inc., reserves the right to make changes in its products or specifications, or both at any time without notice. The information furnished by Micrel is believed to be accurate and reliable. However, Micrel makes no guarantee or warranty concerning the accuracy of said information and shall not be responsible for any loss or damage of whatever nature resulting from the use of, or reliance upon this product.

LIFE SUPPORT POLICY: Micrel's products are not authorized for use as critical components in life support devices or systems without the express written approval of the President of Micrel Inc.