

Switching Transistor

PNP Silicon

MPS3638A

- This device is available in Pb-free package(s). Specifications herein apply to both standard and Pb-free devices. Please see our website at www.onsemi.com for specific Pb-free orderable part numbers, or contact your local ON Semiconductor sales office or representative.

MAXIMUM RATINGS

Rating	Symbol	Value	Unit
Collector – Emitter Voltage	V_{CEO}	-25	Vdc
Collector – Emitter Voltage	V_{CES}	-25	Vdc
Collector – Base Voltage	V_{CBO}	-25	Vdc
Emitter – Base Voltage	V_{EBO}	-4.0	Vdc
Collector Current — Continuous	I_C	-500	mAdc
Total Device Dissipation @ $T_A = 25^\circ\text{C}$ Derate above 25°C	P_D	625 5.0	mW mW/ $^\circ\text{C}$
Total Device Dissipation @ $T_C = 25^\circ\text{C}$ Derate above 25°C	P_D	1.5 12	Watts mW/ $^\circ\text{C}$
Operating and Storage Junction Temperature Range	T_J, T_{stg}	-55 to +150	$^\circ\text{C}$

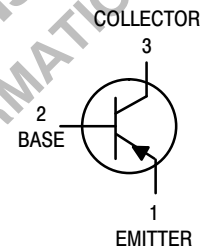
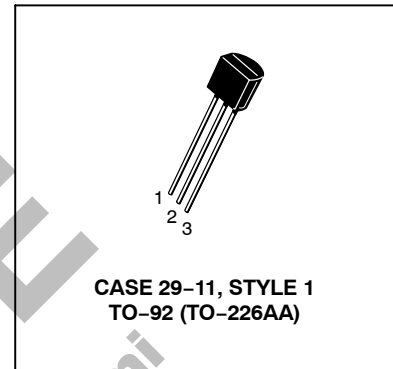

THERMAL CHARACTERISTICS

Characteristic	Symbol	Max	Unit
Thermal Resistance, Junction to Ambient	$R_{\theta JA}^{(1)}$	200	$^\circ\text{C/W}$
Thermal Resistance, Junction to Case	$R_{\theta JC}$	83.3	$^\circ\text{C/W}$

ELECTRICAL CHARACTERISTICS ($T_A = 25^\circ\text{C}$ unless otherwise noted)

Characteristic	Symbol	Min	Max	Unit
----------------	--------	-----	-----	------

OFF CHARACTERISTICS

Collector – Emitter Breakdown Voltage ($I_C = -100 \mu\text{Adc}$, $V_{BE} = 0$)	$V_{(BR)CES}$	-25	—	Vdc
Collector – Emitter Sustaining Voltage ⁽²⁾ ($I_C = -10 \text{mAdc}$, $I_B = 0$)	$V_{CEO(sus)}$	-25	—	Vdc
Collector – Base Breakdown Voltage ($I_C = -100 \mu\text{Adc}$, $I_E = 0$)	$V_{(BR)CBO}$	-25	—	Vdc
Emitter – Base Breakdown Voltage ($I_E = -100 \mu\text{Adc}$, $I_C = 0$)	$V_{(BR)EBO}$	-4.0	—	Vdc
Collector Cutoff Current ($V_{CE} = -15 \text{Vdc}$, $V_{BE} = 0$) ($V_{CE} = -15 \text{Vdc}$, $V_{BE} = 0$, $T_A = -65^\circ\text{C}$)	I_{CES}	—	-0.035 -2.0	μAdc
Emitter Cutoff Current ($V_{EB} = -3.0 \text{V}$, $I_C = 0$)	I_{EBO}	—	-35	nA
Base Current ($V_{CE} = -15 \text{Vdc}$, $V_{BE} = 0$)	I_B	—	-0.035	μAdc

- $R_{\theta JA}$ is measured with the device soldered into a typical printed circuit board.
- Pulse Test: Pulse Width $\leq 300 \mu\text{s}$; Duty Cycle $\leq 2.0\%$.

MPS3638A

ELECTRICAL CHARACTERISTICS ($T_A = 25^\circ\text{C}$ unless otherwise noted) (Continued)

Characteristic	Symbol	Min	Max	Unit
ON CHARACTERISTICS⁽²⁾				
DC Current Gain ($I_C = -1.0\text{ mAdc}$, $V_{CE} = -10\text{ Vdc}$) ($I_C = -10\text{ mAdc}$, $V_{CE} = -10\text{ Vdc}$) ($I_C = -50\text{ mAdc}$, $V_{CE} = -1.0\text{ Vdc}$) ($I_C = -300\text{ mAdc}$, $V_{CE} = -2.0\text{ Vdc}$)	h_{FE}	80 100 100 20	— — — —	—
Collector – Emitter Saturation Voltage ($I_C = -50\text{ mAdc}$, $I_B = -2.5\text{ mAdc}$) ($I_C = -300\text{ mAdc}$, $I_B = -30\text{ mAdc}$)	$V_{CE(sat)}$	— —	-0.25 -1.0	Vdc
Base – Emitter Saturation Voltage ($I_C = -50\text{ mAdc}$, $I_B = -2.5\text{ mAdc}$) ($I_C = -300\text{ mAdc}$, $I_B = -30\text{ mAdc}$)	$V_{BE(sat)}$	— -0.80	-1.1 -2.0	Vdc

SMALL-SIGNAL CHARACTERISTICS

Current – Gain — Bandwidth Product ($V_{CE} = -3.0\text{ Vdc}$, $I_C = -50\text{ mAdc}$, $f = 100\text{ MHz}$)	f_T	150	—	MHz
Output Capacitance ($V_{CB} = -10\text{ Vdc}$, $I_E = 0$, $f = 1.0\text{ MHz}$)	C_{obo}	—	10	pF
Input Capacitance ($V_{EB} = -0.5\text{ Vdc}$, $I_C = 0$, $f = 1.0\text{ MHz}$)	C_{ibo}	—	25	pF
Input Impedance ($I_C = -10\text{ mAdc}$, $V_{CE} = -10\text{ Vdc}$, $f = 1.0\text{ kHz}$)	h_{ie}	—	2000	$k\Omega$
Voltage Feedback Ratio ($I_C = -10\text{ mAdc}$, $V_{CE} = -10\text{ Vdc}$, $f = 1.0\text{ kHz}$)	h_{re}	—	15	$\times 10^{-4}$
Small-Signal Current Gain ($I_C = -10\text{ mAdc}$, $V_{CE} = -10\text{ Vdc}$, $f = 1.0\text{ kHz}$)	h_{fe}	100	—	—
Output Admittance ($I_C = -10\text{ mAdc}$, $V_{CE} = -10\text{ Vdc}$, $f = 1.0\text{ kHz}$)	h_{oe}	—	1.2	mmhos

SWITCHING CHARACTERISTICS

Delay Time	$(V_{CC} = -10\text{ Vdc}$, $I_C = -300\text{ mAdc}$, $I_{B1} = -30\text{ mAdc}$)	t_d	—	20	ns
Rise Time		t_r	—	70	ns
Storage Time	$(V_{CC} = -10\text{ Vdc}$, $I_C = -300\text{ mAdc}$, $I_{B1} = -30\text{ mAdc}$, $I_{B2} = -30\text{ mAdc}$)	t_s	—	140	ns
Fall Time		t_f	—	70	ns
Turn-On Time	$(I_C = -300\text{ mAdc}$, $I_{B1} = -30\text{ mAdc}$)	t_{on}	—	75	ns
Turn-Off Time	$(I_C = -300\text{ mAdc}$, $I_{B1} = -30\text{ mAdc}$, $I_{B2} = 30\text{ mAdc}$)	t_{off}	—	170	ns

2. Pulse Test: Pulse Width $\leq 300\ \mu\text{s}$; Duty Cycle $\leq 2.0\%$.

MPS3638A

SWITCHING TIME EQUIVALENT TEST CIRCUIT

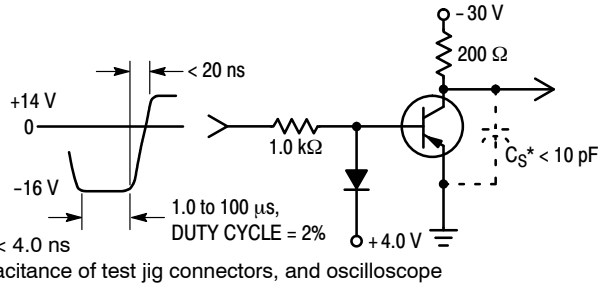
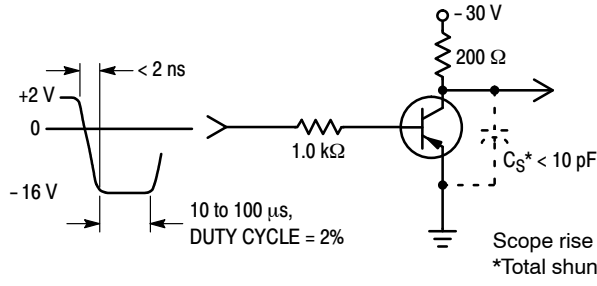

TRANSIENT CHARACTERISTICS

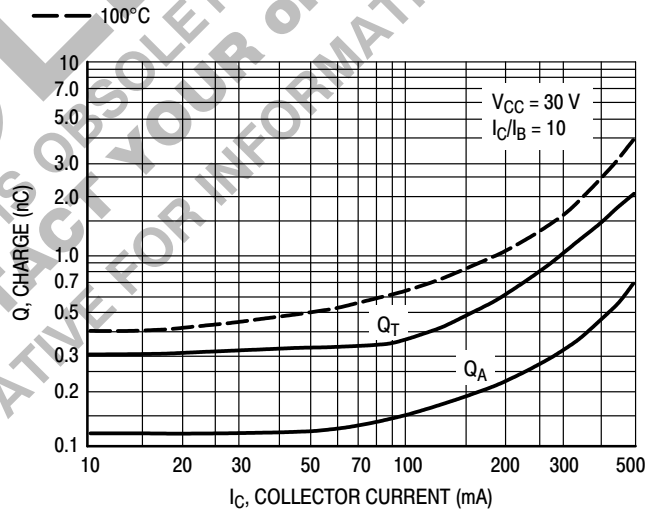
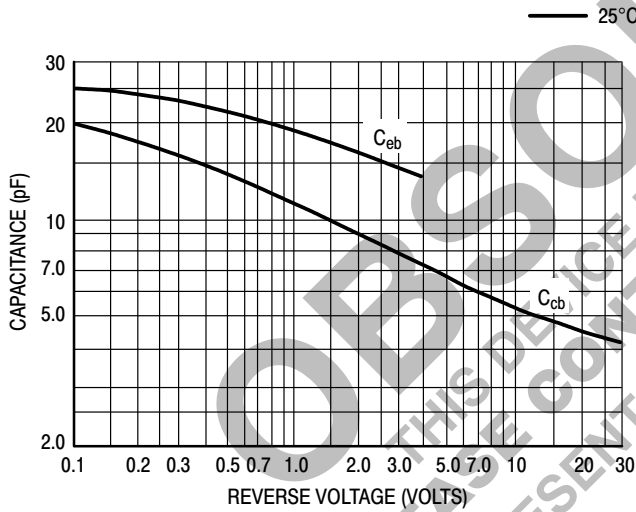

MPS3638A

TRANSIENT CHARACTERISTICS (Continued)

— 25°C - - - 100°C

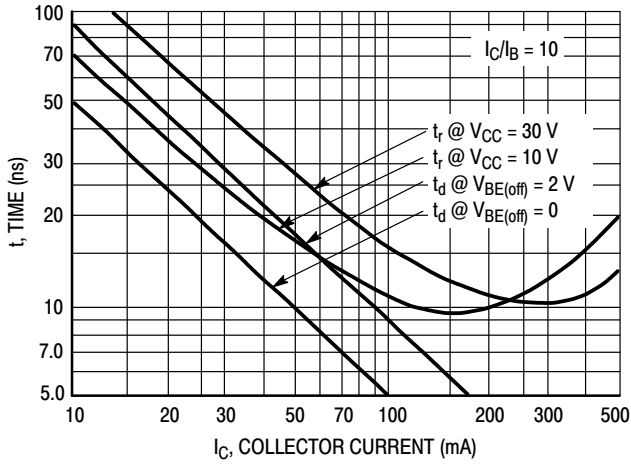

Figure 5. Turn-On Time

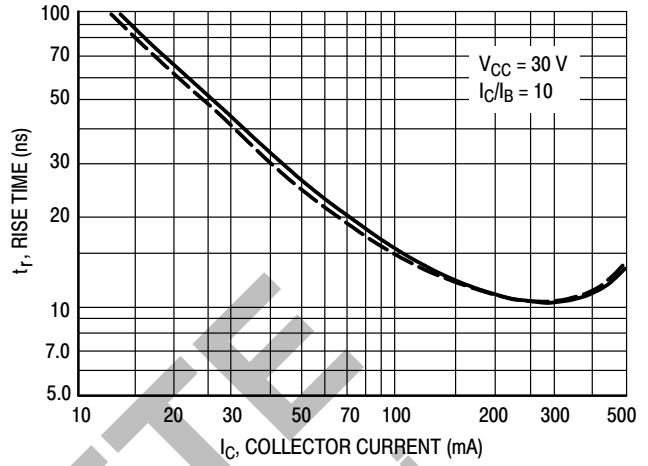

Figure 6. Rise Time

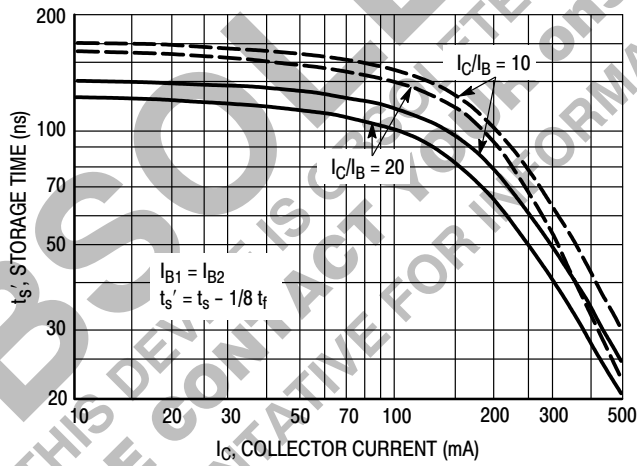

Figure 7. Storage Time

MPS3638A

SMALL-SIGNAL CHARACTERISTICS NOISE FIGURE

$V_{CE} = -10 \text{ Vdc}$, $T_A = 25^\circ\text{C}$

Bandwidth = 1.0 Hz

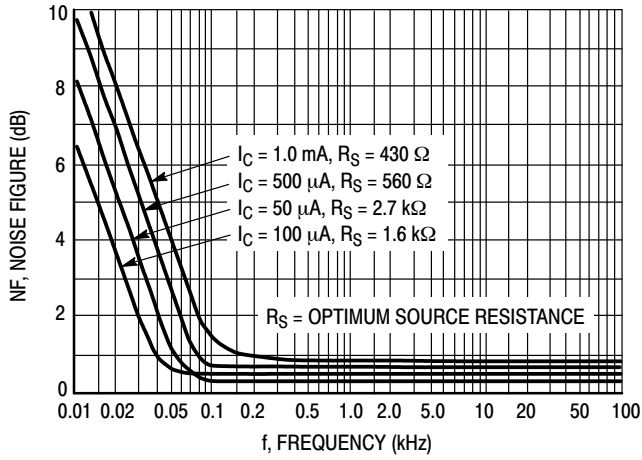

Figure 8. Frequency Effects

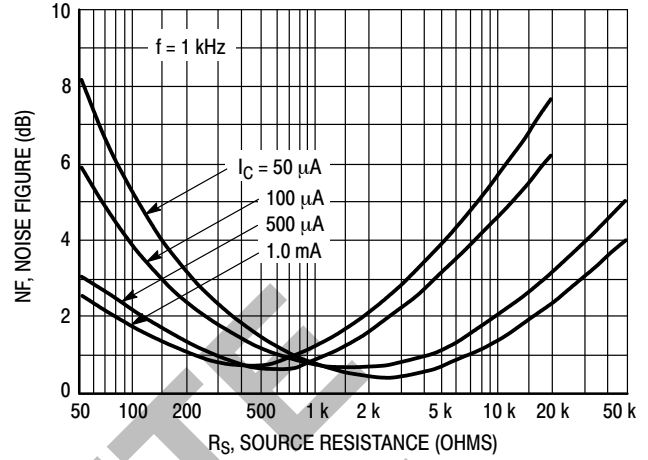

Figure 9. Source Resistance Effects

OBSOLETE
THIS DEVICE IS OBSOLETE
PLEASE CONTACT YOUR onsemi
REPRESENTATIVE FOR INFORMATION

MPS3638A

h PARAMETERS

$V_{CE} = -10 \text{ Vdc}$, $f = 1.0 \text{ kHz}$, $T_A = 25^\circ\text{C}$

This group of graphs illustrates the relationship between h_{fe} and other "h" parameters for this series of transistors. To obtain these curves, a high-gain and a low-gain unit were

selected from the 2N4402 line, and the same units were used to develop the correspondingly-numbered curves on each graph.

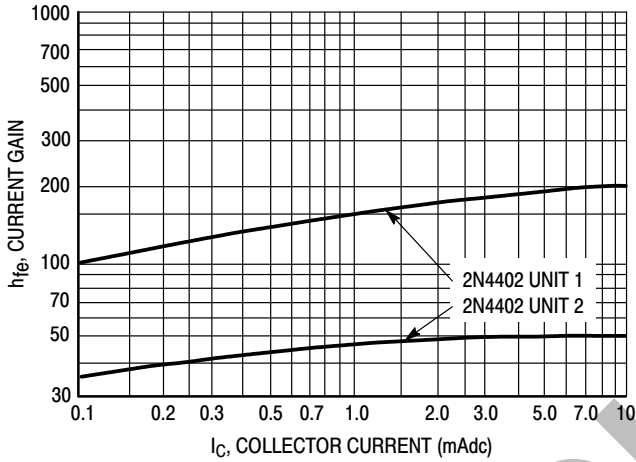

Figure 10. Current Gain

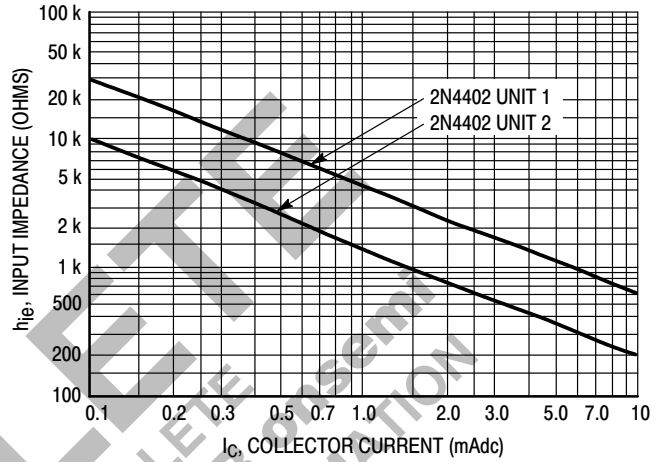

Figure 11. Input Impedance

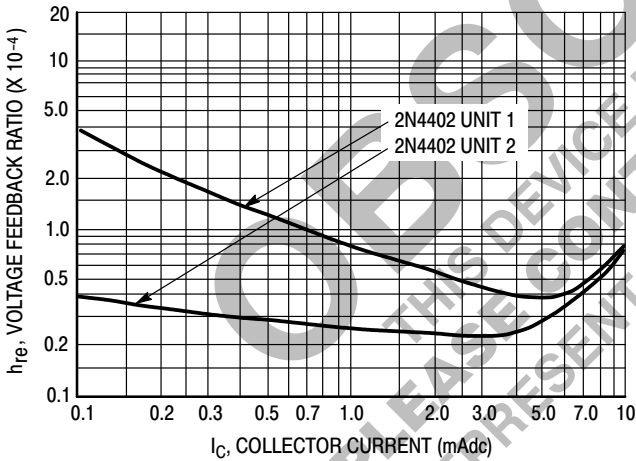

Figure 12. Voltage Feedback Ratio

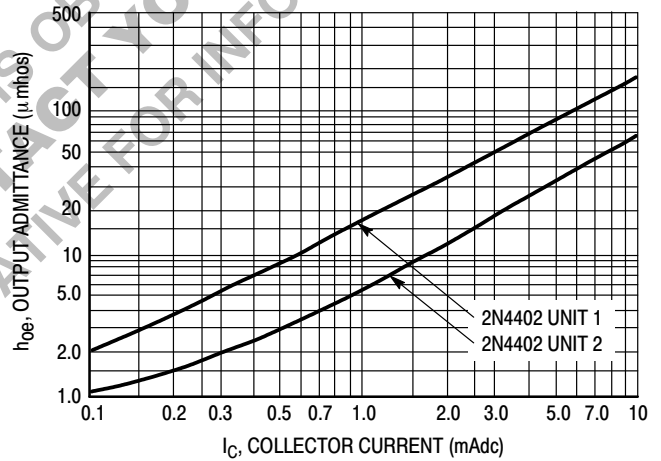

Figure 13. Output Admittance

MPS3638A

STATIC CHARACTERISTICS

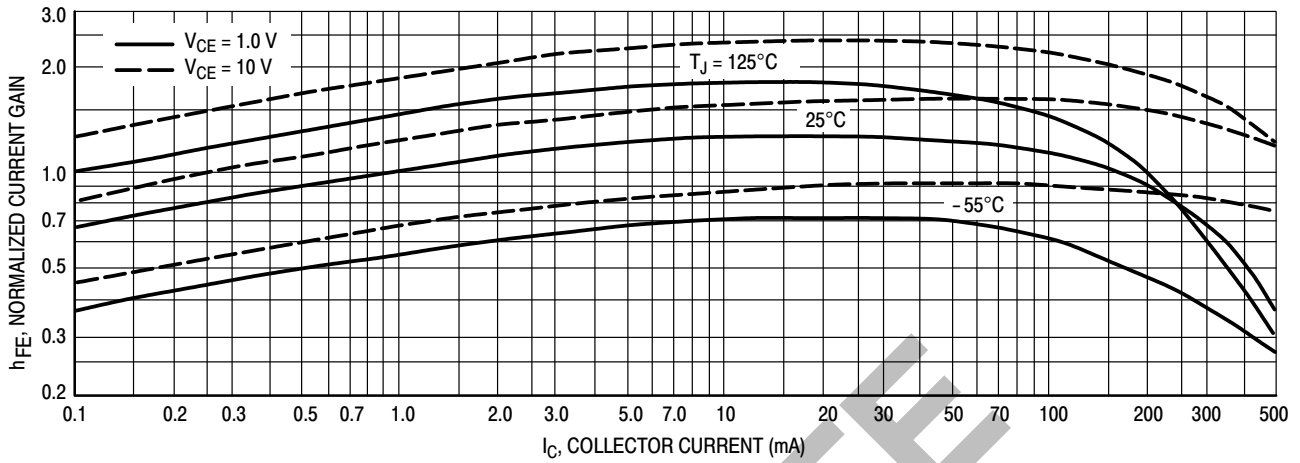

Figure 14. DC Current Gain

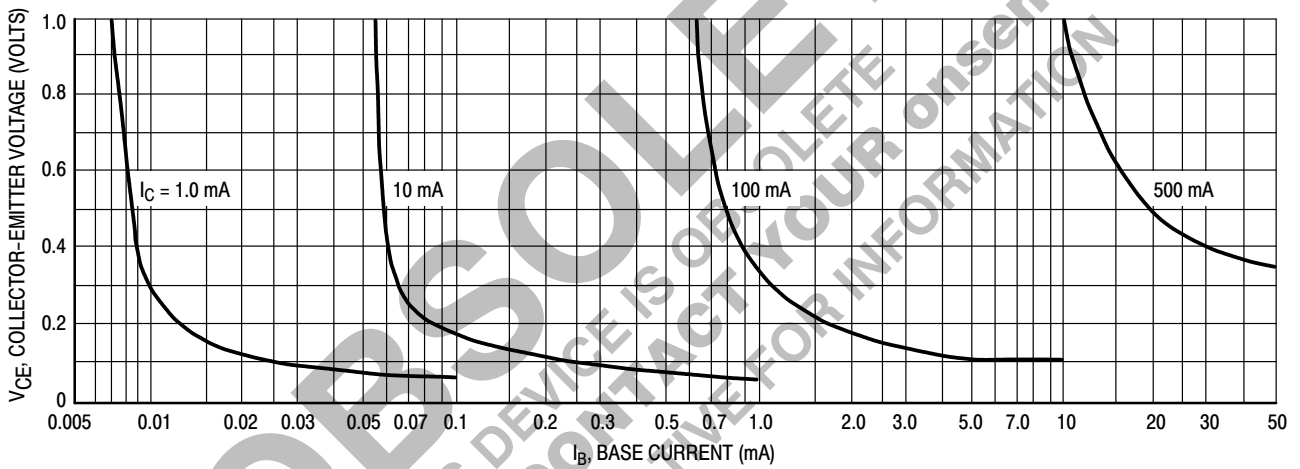

Figure 15. Collector Saturation Region

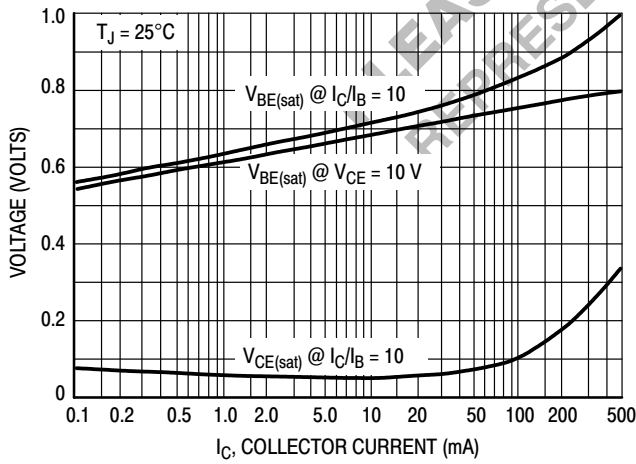

Figure 16. "On" Voltages

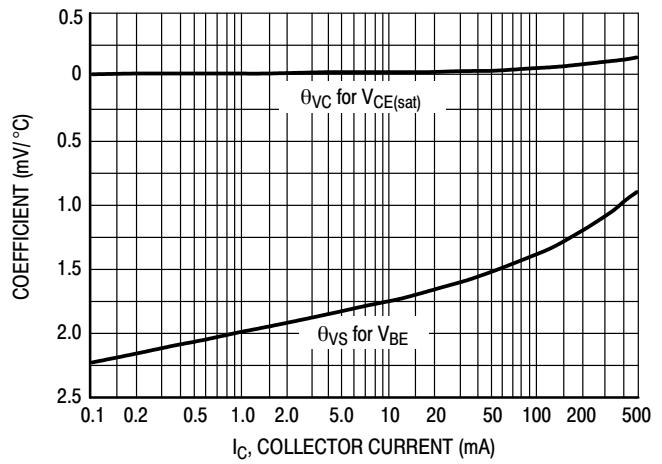
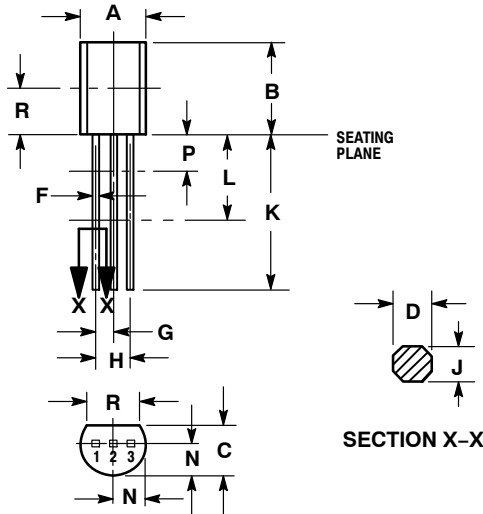

Figure 17. Temperature Coefficients

MPS3638A

PACKAGE DIMENSIONS

CASE 029-11
(TO-226AA)
ISSUE AD



NOTES:

1. DIMENSIONING AND TOLERANCING PER ANSI Y14.5M, 1982.
2. CONTROLLING DIMENSION: INCH.
3. CONTOUR OF PACKAGE BEYOND DIMENSION R IS UNCONTROLLED.
4. DIMENSION F APPLIES BETWEEN P AND L. DIMENSIONS D AND J APPLY BETWEEN L AND K MINIMUM. LEAD DIMENSION IS UNCONTROLLED IN P AND BEYOND DIMENSION K MINIMUM.

DIM	INCHES		MILLIMETERS	
	MIN	MAX	MIN	MAX
A	0.175	0.205	4.44	5.21
B	0.290	0.310	7.37	7.87
C	0.125	0.165	3.18	4.19
D	0.018	0.021	0.457	0.533
F	0.016	0.019	0.407	0.482
G	0.045	0.055	1.15	1.39
H	0.095	0.105	2.42	2.66
J	0.018	0.024	0.46	0.61
K	0.500	---	12.70	---
L	0.250	---	6.35	---
N	0.080	0.105	2.04	2.66
P	---	0.100	---	2.54
R	0.135	---	3.43	---

- STYLE 1:
PIN 1. EMITTER
2. BASE
3. COLLECTOR

OBSOLETE

THIS DEVICE IS OBSOLETE
PLEASE CONTACT YOUR ONSEMI
REPRESENTATIVE FOR INFORMATION

ON Semiconductor and are registered trademarks of Semiconductor Components Industries, LLC (SCILLC). SCILLC reserves the right to make changes without further notice to any products herein. SCILLC makes no warranty, representation or guarantee regarding the suitability of its products for any particular purpose, nor does SCILLC assume any liability arising out of the application or use of any product or circuit, and specifically disclaims any and all liability, including without limitation special, consequential or incidental damages. "Typical" parameters which may be provided in SCILLC data sheets and/or specifications can and do vary in different applications and actual performance may vary over time. All operating parameters, including "Typicals" must be validated for each customer application by customer's technical experts. SCILLC does not convey any license under its patent rights nor the rights of others. SCILLC products are not designed, intended, or authorized for use as components in systems intended for surgical implant into the body, or other applications intended to support or sustain life, or for any other application in which the failure of the SCILLC product could create a situation where personal injury or death may occur. Should Buyer purchase or use SCILLC products for any such unintended or unauthorized application, Buyer shall indemnify and hold SCILLC and its officers, employees, subsidiaries, affiliates, and distributors harmless against all claims, costs, damages, and expenses, and reasonable attorney fees arising out of, directly or indirectly, any claim of personal injury or death associated with such unintended or unauthorized use, even if such claim alleges that SCILLC was negligent regarding the design or manufacture of the part. SCILLC is an Equal Opportunity/Affirmative Action Employer. This literature is subject to all applicable copyright laws and is not for resale in any manner.

PUBLICATION ORDERING INFORMATION

LITERATURE FULFILLMENT:
Literature Distribution Center for ON Semiconductor
P.O. Box 61312, Phoenix, Arizona 85082-1312 USA
Phone: 480-829-7710 or 800-344-3860 Toll Free USA/Canada
Fax: 480-829-7709 or 800-344-3867 Toll Free USA/Canada
Email: orderlit@onsemi.com

N. American Technical Support: 800-282-9855 Toll Free USA/Canada

Japan: ON Semiconductor, Japan Customer Focus Center
2-9-1 Kamimeguro, Meguro-ku, Tokyo, Japan 153-0051
Phone: 81-3-5773-3850

ON Semiconductor Website: <http://onsemi.com>

Order Literature: <http://www.onsemi.com/litorder>

For additional information, please contact your local Sales Representative.