

74ACTQ823 Quiet Series™ 9-Bit D-Type Flip-Flop with 3-STATE Outputs

General Description

The ACTQ823 is a 9-bit buffered register. It features Clock Enable and Clear which are ideal for parity bus interfacing in high performance microprogramming systems. The ACTQ823 utilizes Fairchild Quiet Series™ technology to guarantee quiet output switching and improved dynamic threshold performance. FACT Quiet Series™ features GTO™ output control and undershoot corrector in addition to a split ground bus for superior performance.

Features

- Guaranteed simultaneous switching noise level and dynamic threshold performance
- Guaranteed pin-to-pin skew AC performance
- Inputs and outputs on opposite sides of package allow easy interface with microprocessors
- Improved latch-up immunity
- Has TTL-compatible inputs

Ordering Code:

Order Number	Package Number	Package Description
74ACTQ823SC	M24B	24-Lead Small Outline Integrated Circuit (SOIC), JEDEC MS-013, 0.300" Wide Body
74ACTQ823SPC	N24C	24-Lead Plastic Dual-In-Line Package (PDIP), JEDEC MS-100, 0.300" Wide

Device also available in Tape and Reel. Specify by appending suffix letter "X" to the ordering form.

Logic Symbols

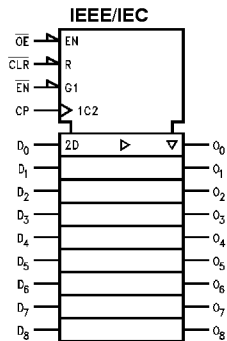
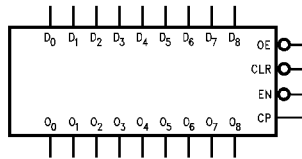

Connection Diagram

Pin Assignment
for DIP and SOIC

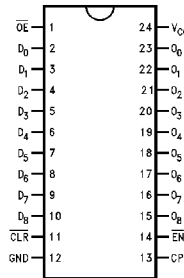

Pin Descriptions

Pin Names	Description
D ₀ -D ₈	Data Inputs
O ₀ -O ₈	Data Outputs
\overline{OE}	Output Enable
\overline{CLR}	Clear
CP	Clock Input
\overline{EN}	Clock Enable

FACT™, Quiet Series™, FACT Quiet Series™ and GTO™ are trademarks of Fairchild Semiconductor Corporation.

Functional Description

The ACTQ823 consists of nine D-type edge-triggered flip-flops. These have 3-STATE outputs for bus systems organized with inputs and outputs on opposite sides. The buffered clock (CP) and buffered Output Enable (\overline{OE}) are common to all flip-flops. The flip-flops will store the state of their individual D inputs that meet the setup and hold time requirements on the LOW-to-HIGH CP transition. With \overline{OE} LOW, the contents of the flip-flops are available at the outputs. When \overline{OE} is HIGH, the outputs go to the high impedance state. Operation of the \overline{OE} input does not affect the state of the flip-flops. In addition to the Clock and Output

Enable pins, there are Clear (\overline{CLR}) and Clock Enable (\overline{EN}) pins. These devices are ideal for parity bus interfacing in high performance systems.

When \overline{CLR} is LOW and \overline{OE} is LOW, the outputs are LOW. When \overline{CLR} is HIGH, data can be entered into the flip-flops. When \overline{EN} is LOW, data on the inputs is transferred to the outputs on the LOW-to-HIGH clock transition. When the \overline{EN} is HIGH, the outputs do not change state, regardless of the data or clock input transitions.

Function Table

Inputs					Internal	Output	Function
\overline{OE}	\overline{CLR}	\overline{EN}	CP	D	Q	O	
H	X	L	↗	L	L	Z	High Z
H	X	L	↗	H	H	Z	High Z
H	L	X	X	X	L	Z	Clear
L	L	X	X	X	L	L	Clear
H	H	H	X	X	NC	Z	Hold
L	H	H	X	X	NC	NC	Hold
H	H	L	↗	L	L	Z	Load
H	H	L	↗	H	H	Z	Load
L	H	L	↗	L	L	L	Load
L	H	L	↗	H	H	H	Load

H = HIGH Voltage Level
 L = LOW Voltage Level
 X = Immaterial
 Z = High Impedance
 ↗ = LOW-to-HIGH Transition
 NC = No Change

Logic Diagram

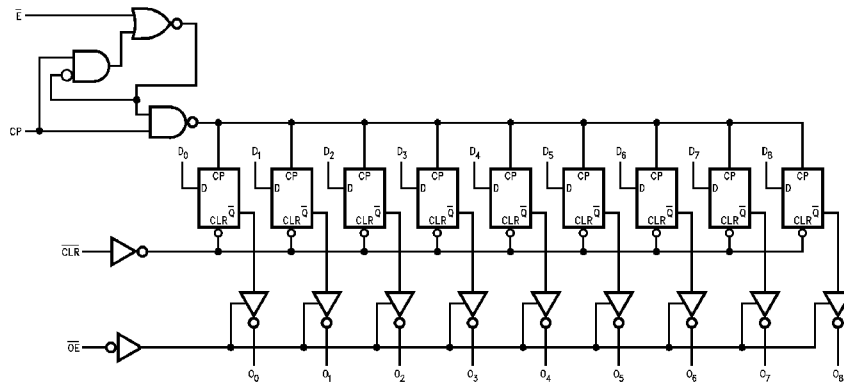

Please note that this diagram is provided only for the understanding of logic operations and should not be used to estimate propagation delays.

Absolute Maximum Ratings (Note 1)		Junction Temperature (T_J)						
Supply Voltage (V_{CC})	-0.5V to +7.0V	PDIP	140°C					
DC Input Diode Current (I_{IK})		Recommended Operating Conditions						
$V_I = -0.5V$	-20 mA	Supply Voltage (V_{CC})	4.5V to 5.5V					
$V_I = V_{CC} + 0.5V$	+20 mA	Input Voltage (V_I)	0V to V_{CC}					
DC Input Voltage (V_I)	-0.5V to $V_{CC} + 0.5V$	Output Voltage (V_O)	0V to V_{CC}					
DC Output Diode Current (I_{OK})		Operating Temperature (T_A)	-40°C to +85°C					
$V_O = -0.5V$	-20 mA	Minimum Input Edge Rate $\Delta V/\Delta t$	125 mV/ns					
$V_O = V_{CC} + 0.5V$	+20 mA	V_{IN} from 0.8V to 2.0V						
DC Output Voltage (V_O)	-0.5V to $V_{CC} + 0.5V$	V_{CC} @ 4.5V, 5.5V						
DC Output Source		Note 1: Absolute maximum ratings are those values beyond which damage to the device may occur. The databook specifications should be met, without exception, to ensure that the system design is reliable over its power supply, temperature, and output/input loading variables. Fairchild does not recommend operation of FACT™ circuits outside databook specifications.						
or Sink Current (I_O)	± 50 mA							
DC V_{CC} or Ground Current								
per Output Pin (I_{CC} or I_{GND})	± 50 mA							
Storage Temperature (T_{STG})	-65°C to +150°C							
DC Latch-Up Source								
or Sink Current	± 300 mA							
DC Electrical Characteristics for ACTQ								
Symbol	Parameter	V_{CC} (V)	$T_A = +25^\circ\text{C}$		$T_A = -40^\circ\text{C to } +85^\circ\text{C}$		Units	Conditions
			Typ	Guaranteed Limits				
V_{IH}	Minimum HIGH Level Input Voltage	4.5	1.5	2.0	2.0	V	$V_{OUT} = 0.1V$ or $V_{CC} - 0.1V$	
		5.5	1.5	2.0	2.0			
V_{IL}	Maximum LOW Level Input Voltage	4.5	1.5	0.8	0.8	V	$V_{OUT} = 0.1V$ or $V_{CC} - 0.1V$	
		5.5	1.5	0.8	0.8			
V_{OH}	Minimum HIGH Level Output Voltage	4.5	4.49	4.4	4.4	V	$I_{OUT} = -50 \mu A$	
		5.5	5.49	5.4	5.4			
		4.5		3.86	3.76	V	$V_{IN} = V_{IL}$ or V_{IH} $I_{OH} = -24$ mA $I_{OH} = -24$ mA (Note 2)	
		5.5		4.86	4.76			
V_{OL}	Maximum LOW Level Output Voltage	4.5	0.001	0.1	0.1	V	$I_{OUT} = 50 \mu A$	
		5.5	0.001	0.1	0.1			
		4.5		0.36	0.44	V	$V_{IN} = V_{IL}$ or V_{IH} $I_{OL} = 24$ mA $I_{OL} = 24$ mA (Note 2)	
		5.5		0.36	0.44			
I_{IN}	Maximum Input Leakage Current	5.5		± 0.1	± 1.0	μA	$V_I = V_{CC}, GND$	
I_{OZ}	Maximum 3-STATE Leakage Current	5.5		± 0.5	± 5.0	μA	$V_I = V_{IL}, V_{IH}$ $V_O = V_{CC}, GND$	
CCT	Maximum $I_{CC}/$ Input	5.5	0.6		1.5	mA	$V_I = V_{CC} - 2.1V$	
I_{OLD}	Minimum Dynamic	5.5			75	mA	$V_{OLD} = 1.65V$ Max	
I_{OHD}	Output Current (Note 2)	5.5			-75	mA	$V_{OHD} = 3.85V$ Min	
I_{CC}	Maximum Quiescent Supply Current	5.5		8.0	80.0	μA	$V_{IN} = V_{CC}$ or GND	
V_{OLP}	Quiet Output	5.0	1.1	1.5		V	Figure 1, Figure 2 (Note 5)(Note 6)	
	Maximum Dynamic V_{OL}							
V_{OLV}	Quiet Output	5.0	-0.6	-1.2		V	Figure 1, Figure 2 (Note 5)(Note 6)	
	Minimum Dynamic V_{OL}							
V_{IHD}	Minimum HIGH Level Dynamic Input Voltage	5.0	1.9	2.2		V	(Note 5)(Note 7)	
V_{ILD}	Maximum LOW Level Dynamic Input Voltage	5.0	1.2	0.8		V	(Note 5)(Note 7)	
<p>Note 2: All outputs loaded; thresholds on input associated with output under test.</p> <p>Note 3: Maximum test duration 2.0 ms, one output loaded at a time.</p> <p>Note 4: Maximum test duration 2.0 ms, one output loaded at a time.</p> <p>Note 5: PDIP package.</p> <p>Note 6: Max number of outputs defined as (n). Data inputs are driven 0V to 3V. One output @ GND.</p>								

DC Electrical Characteristics for ACTQ (Continued)

Note 7: Max number of data inputs (n) switching. (n - 1) inputs switching 0V to 3V Input-under-test switching: 3V to threshold (V_{ILD}), 0V to threshold (V_{IHD}), $f = 1$ MHz.

AC Electrical Characteristics

Symbol	Parameter	V _{CC} (V) (Note 8)	T _A = +25°C C _L = 50 pF			T _A = -40°C to +85°C C _L = 50 pF		Units
			Min	Typ	Max	Min	Max	
t _{PLH} t _{PHL}	Propagation Delay CP to O _n	5.0	2.0	7.0	9.0	2.0	10.0	ns
t _{PLH} t _{PHL}	Propagation Delay CLR to O _n	5.0	2.0	7.0	9.0	2.0	10.0	ns
t _{PZH} t _{PZL}	Output Enable Time \overline{OE} to O _n	5.0	2.5	8.0	10.0	2.5	11.0	ns
t _{PHZ} t _{PLZ}	Output Disable Time \overline{OE} to O _n	5.0	1.0	6.0	8.0	1.0	9.0	ns
t _{OSLH} t _{OSHL}	Output to Output Skew D _n to O _n (Note 9)	5.0		0.5	1.0		1.0	ns

Note 8: Voltage Range 5.0 is 5.0V ±0.5V.

Note 9: Skew is defined as the absolute value of the difference between the actual propagation delay for any two outputs within the same packaged device. The specification applies to any outputs switching in the same direction, either HIGH to LOW (t_{OSHL}) or LOW to HIGH (t_{OSLH}). Parameter guaranteed by design. Not tested.

AC Operating Requirements

Symbol	Parameter	V _{CC} (V) (Note 10)	T _A = +25°C C _L = 50 pF		T _A = -40°C to +85°C C _L = 50 pF		Units
			Typ	Guaranteed Minimum	Typ	Guaranteed Minimum	
t _S	Setup Time, HIGH or LOW D to CP	5.0	0.5	3.0	3.0		ns
t _H	Hold Time, HIGH or LOW D _n to CP	5.0	0	1.5	1.5		ns
t _S	Setup Time, HIGH or LOW \overline{EN} to CP	5.0	0	3.0	3.0		ns
t _H	Hold Time, HIGH or LOW \overline{EN} to CP	5.0	0	1.5	1.5		ns
t _W	CP Pulse Width HIGH or LOW	5.0	2.5	4.0	4.0		ns
t _W	\overline{CLR} Pulse Width, LOW	5.0	3.0	4.0	4.0		ns
t _{rec}	\overline{CLR} to CP Recovery Time	5.0	1.5	3.5	4.0		ns

Note 10: Voltage Range 5.0 is 5.0V ±0.5V

Capacitance

Symbol	Parameter	Typ	Units	Conditions
C _{IN}	Input Capacitance	4.5	pF	V _{CC} = OPEN
C _{PD}	Power Dissipation Capacitance	54	pF	V _{CC} = 5.0V

FACT Noise Characteristics

The setup of a noise characteristics measurement is critical to the accuracy and repeatability of the tests. The following is a brief description of the setup used to measure the noise characteristics of FACT.

Equipment:

- Hewlett Packard Model 8180A Word Generator
- PC-163A Test Fixture
- Tektronics Model 7854 Oscilloscope

Procedure:

1. Verify Test Fixture Loading: Standard Load 50 pF, 500Ω.
2. Deskew the HFS generator so that no two channels have greater than 150 ps skew between them. This requires that the oscilloscope be deskewed first. It is important to deskew the HFS generator channels before testing. This will ensure that the outputs switch simultaneously.
3. Terminate all inputs and outputs to ensure proper loading of the outputs and that the input levels are at the correct voltage.
4. Set the HFS generator to toggle all but one output at a frequency of 1 MHz. Greater frequencies will increase DUT heating and effect the results of the measurement.

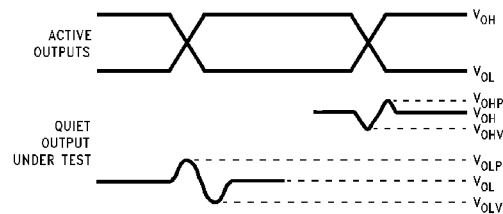

V_{OHV} and V_{OLP} are measured with respect to ground reference.

Input pulses have the following characteristics: $f = 1$ MHz, $t_r = 3$ ns, $t_f = 3$ ns, skew < 150 ps.

FIGURE 1. Quiet Output Noise Voltage Waveforms

5. Set the HFS generator input levels at 0V LOW and 3V HIGH for ACT devices and 0V LOW and 5V HIGH for AC devices. Verify levels with an oscilloscope.

V_{OLP}/V_{OLV} and V_{OHP}/V_{OHV} :

- Determine the quiet output pin that demonstrates the greatest noise levels. The worst case pin will usually be the furthest from the ground pin. Monitor the output voltages using a 50Ω coaxial cable plugged into a standard SMB type connector on the test fixture. Do not use an active FET probe.
- Measure V_{OLP} and V_{OLV} on the quiet output during the worst case transition for active and enable. Measure V_{OHP} and V_{OHV} on the quiet output during the worst case transition for active and enable.
- Verify that the GND reference recorded on the oscilloscope has not drifted to ensure the accuracy and repeatability of the measurements.

V_{ILD} and V_{IHD} :

- Monitor one of the switching outputs using a 50Ω coaxial cable plugged into a standard SMB type connector on the test fixture. Do not use an active FET probe.
- First increase the input LOW voltage level, V_{IL} , until the output begins to oscillate or steps out a min of 2 ns. Oscillation is defined as noise on the output LOW level that exceeds V_{IL} limits, or on output HIGH levels that exceed V_{IH} limits. The input LOW voltage level at which oscillation occurs is defined as V_{ILD} .
- Next decrease the input HIGH voltage level, V_{IH} , until the output begins to oscillate or steps out a min of 2 ns. Oscillation is defined as noise on the output LOW level that exceeds V_{IL} limits, or on output HIGH levels that exceed V_{IH} limits. The input HIGH voltage level at which oscillation occurs is defined as V_{IHD} .
- Verify that the GND reference recorded on the oscilloscope has not drifted to ensure the accuracy and repeatability of the measurements.

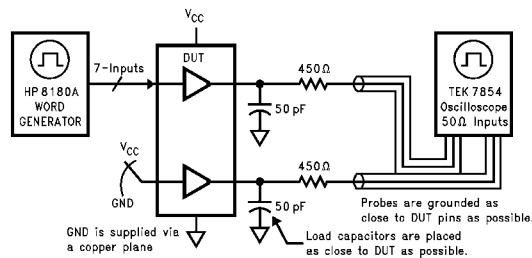
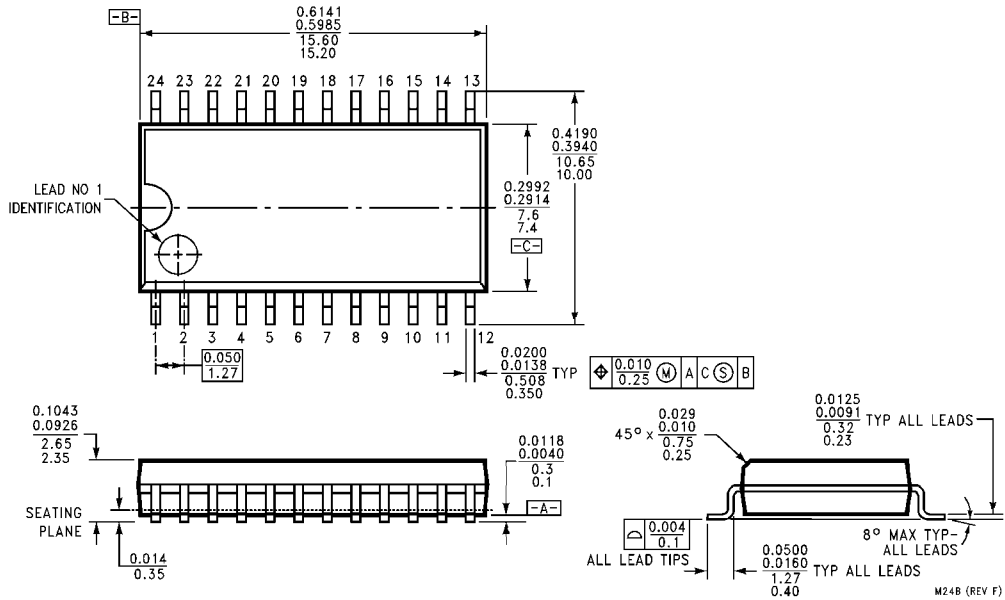

FIGURE 2. Simultaneous Switching Test Circuit

74ACT0823

Physical Dimensions inches (millimeters) unless otherwise noted



**24-Lead Small Outline Integrated Circuit (SOIC), JEDEC MS-013, 0.300" Wide Body
Package Number M24B**

M24B (REV F)

Physical Dimensions inches (millimeters) unless otherwise noted (Continued)

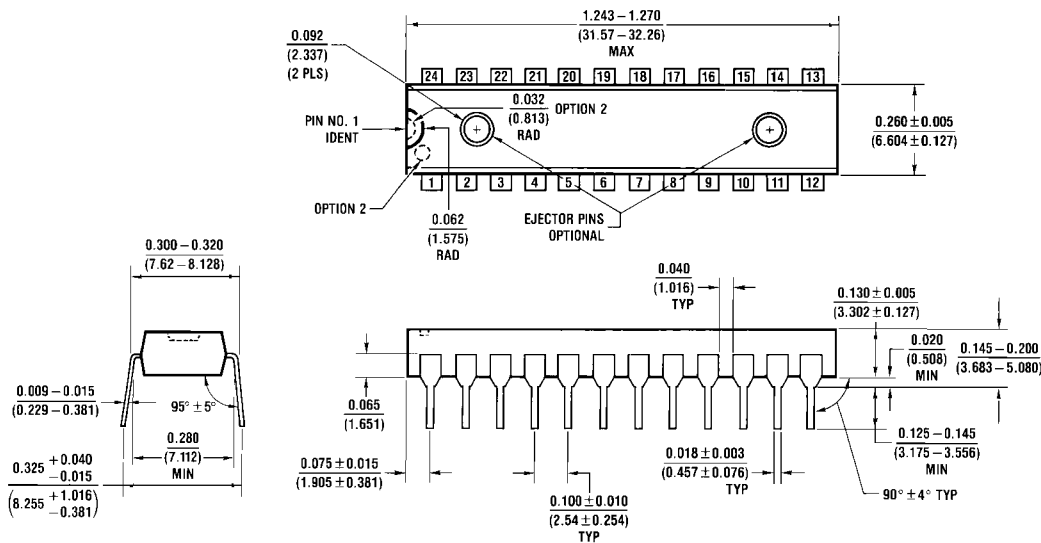

**24-Lead Plastic Dual-In-Line Package (PDIP), JEDEC MS-100, 0.300" Wide
 Package Number N24C**

LIFE SUPPORT POLICY

FAIRCHILD'S PRODUCTS ARE NOT AUTHORIZED FOR USE AS CRITICAL COMPONENTS IN LIFE SUPPORT DEVICES OR SYSTEMS WITHOUT THE EXPRESS WRITTEN APPROVAL OF THE PRESIDENT OF FAIRCHILD SEMICONDUCTOR CORPORATION. As used herein:

1. Life support devices or systems are devices or systems which, (a) are intended for surgical implant into the body, or (b) support or sustain life, and (c) whose failure to perform when properly used in accordance with instructions for use provided in the labeling, can be reasonably expected to result in a significant injury to the user.
2. A critical component in any component of a life support device or system whose failure to perform can be reasonably expected to cause the failure of the life support device or system, or to affect its safety or effectiveness.

www.fairchildsemi.com