

100 V, 2 A power Schottky rectifier

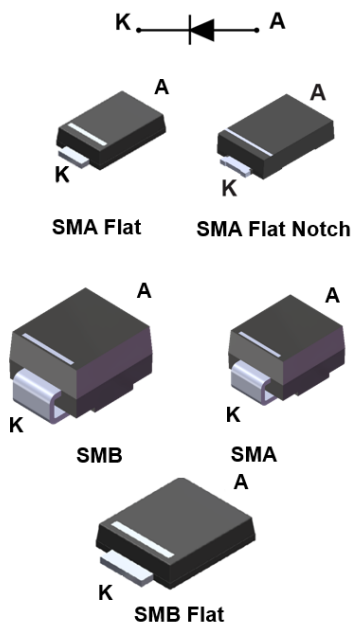

Features

- Negligible switching losses
- High junction temperature capability
- Low leakage current
- Good trade-off between leakage current and forward voltage drop
- Avalanche capability specified
- ECOPACK2 component

Applications

- Switching diode
- Battery charger
- SMPS
- DC / DC converter
- Telecom power
- LED lighting

Description

This Schottky rectifier is designed for high frequency miniature switched mode power supplies such as adaptors and on board DC/DC converters.

Packaged in SMA, SMA Flat, SMB, SMB Flat and SMA Flat Notch, the [STPS2H100](#) is ideal for use in lighting and telecom power applications.

Product status link

[STPS2H100](#)

Product summary

| Symbol | Value |
|--------------|--------|
| $I_{F(AV)}$ | 2 A |
| V_{RRM} | 100 V |
| T_j (max.) | 175 °C |
| V_F (max.) | 0.65 V |

1 Characteristics

Table 1. Absolute ratings (limiting values at 25 °C, unless otherwise specified)

| Symbol | Parameter | | Value | Unit | |
|--------------------|---|--------------------------|---|------|----|
| V _{RRM} | Repetitive peak reverse voltage | | 100 | V | |
| I _{F(AV)} | Average forward current | SMA | T _I = 130 °C, δ = 0.5 | 2 | A |
| | | SMB | T _I = 135 °C, δ = 0.5 | | |
| | | SMA Flat, SMA Flat Notch | T _I = 145 °C, δ = 0.5 | | |
| | | SMB Flat | T _I = 150 °C, δ = 0.5 | | |
| I _{FSM} | Surge non repetitive forward current | | t _p = 10 ms sinusoidal | 75 | A |
| P _{ARM} | Repetitive peak avalanche power | | t _p = 10 μs, T _j = 125 °C | 173 | W |
| T _{stg} | Storage temperature range | | -65 to +175 | | °C |
| T _j | Maximum operating junction temperature ⁽¹⁾ | | 175 | | °C |

1. $(dP_{tot}/dT_j) < (1/R_{th(j-a)})$ condition to avoid thermal runaway for a diode on its own heatsink.

Table 2. Thermal resistance parameters

| Symbol | Parameter | | Max. value | Unit |
|----------------------|------------------|--------------------------|------------|------|
| R _{th(j-l)} | Junction to lead | SMA | 30 | °C/W |
| | | SMA Flat, SMA Flat Notch | 20 | |
| | | SMB | 25 | |
| | | SMB Flat | 15 | |

For more information, please refer to the following application note :

- AN5088 : Rectifiers thermal management, handling and mounting recommendations

Table 3. Static electrical characteristics

| Symbol | Parameter | Test conditions | | Min. | Typ. | Max. | Unit |
|-------------------------------|-------------------------|-------------------------|-----------------------------------|------|------|------|------|
| I _R ⁽¹⁾ | Reverse leakage current | T _j = 25 °C | V _R = V _{RRM} | - | | 1.00 | μA |
| | | T _j = 125 °C | | - | 0.40 | 1.00 | mA |
| V _F ⁽²⁾ | Forward voltage drop | T _j = 25 °C | I _F = 2 A | - | | 0.79 | V |
| | | T _j = 125 °C | | - | 0.60 | 0.65 | |
| | | T _j = 25 °C | I _F = 4 A | - | | 0.88 | |
| | | T _j = 125 °C | | - | 0.69 | 0.74 | |

1. Pulse test: t_p = 5 ms, δ < 2%

2. Pulse test: t_p = 380 μs, δ < 2%

To evaluate the conduction losses, use the following equation:

$$P = 0.56 \times I_{F(AV)} + 0.045 \times I_{F(RMS)}^2$$

For more information, please refer to the following application notes related to the power losses :

- AN604: Calculation of conduction losses in a power rectifier
- AN4021: Calculation of reverse losses on a power diode

1.1 Characteristics (curves)

Figure 1. Average forward power dissipation versus average forward current

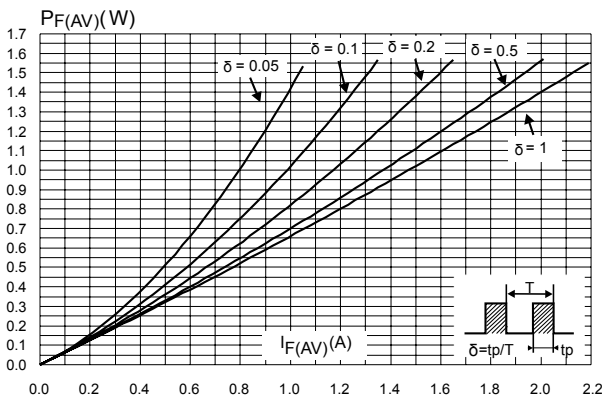

Figure 2. Average forward current versus ambient temperature ($\delta = 0.5$, SMA / SMB)

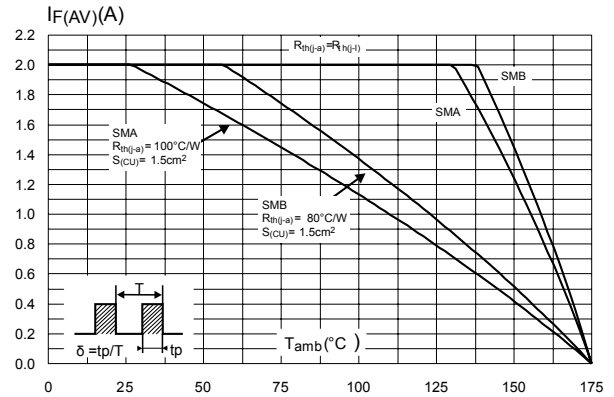

Figure 3. Average forward current versus ambient temperature ($\delta = 0.5$, SMB Flat)

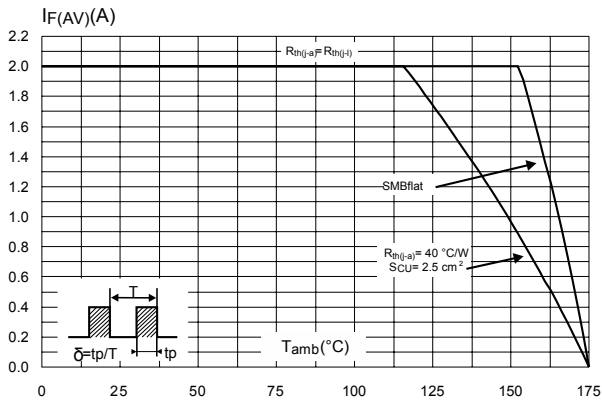

Figure 4. Average forward current versus ambient temperature ($\delta = 0.5$, SMA Flat, SMA Flat Notch)

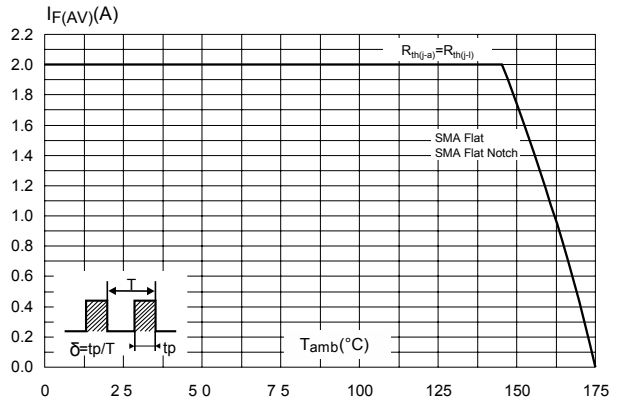

Figure 5. Normalized avalanche power derating versus junction temperature ($T_j = 125\text{ }^\circ\text{C}$)

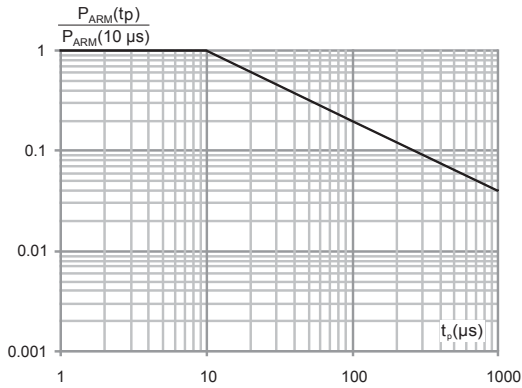

Figure 6. Relative variation of thermal impedance junction to ambient versus pulse duration (SMA)

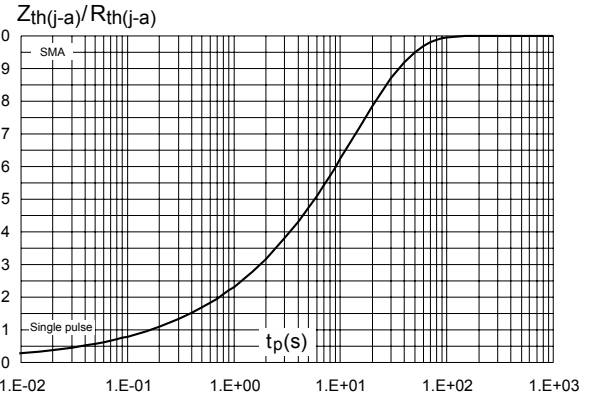

Figure 7. Relative variation of thermal impedance junction to lead versus pulse duration (SMA Flat, SMA Flat Notch)

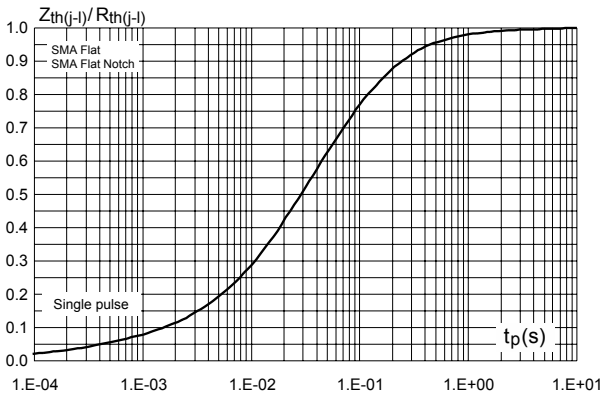

Figure 8. Relative variation of thermal impedance junction to ambient versus pulse duration (SMB)

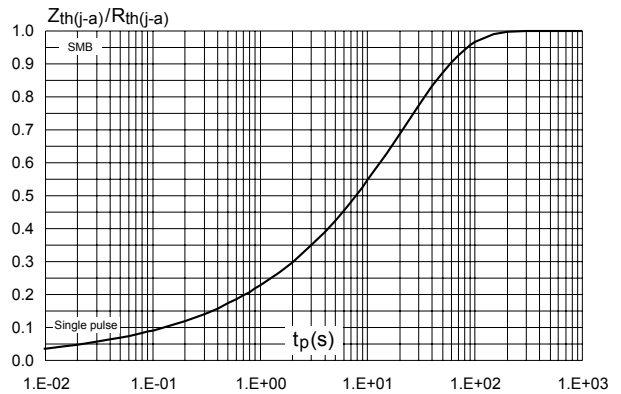

Figure 9. Relative variation of thermal impedance junction to lead versus pulse duration (SMB Flat)

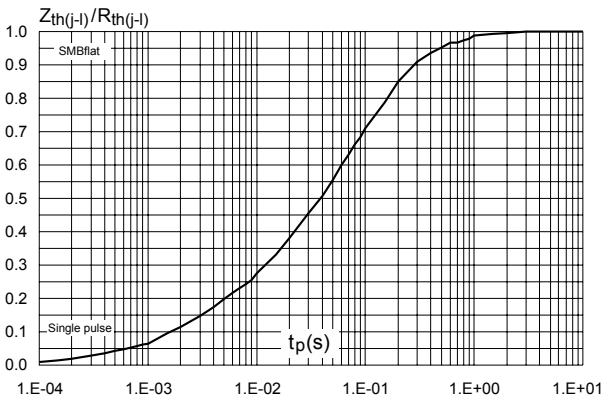

Figure 10. Reverse leakage current versus reverse voltage applied (typical values)

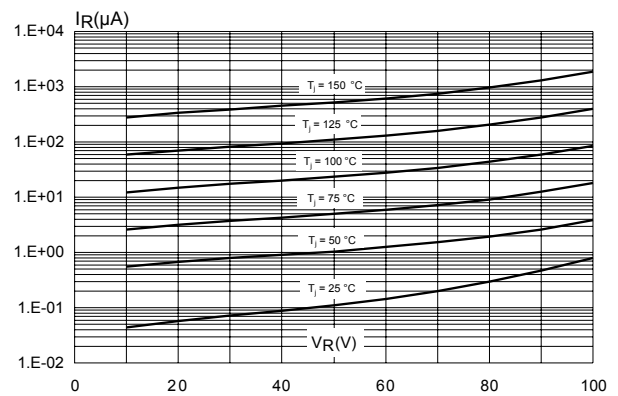

Figure 11. Junction capacitance versus reverse voltage applied (typical values)

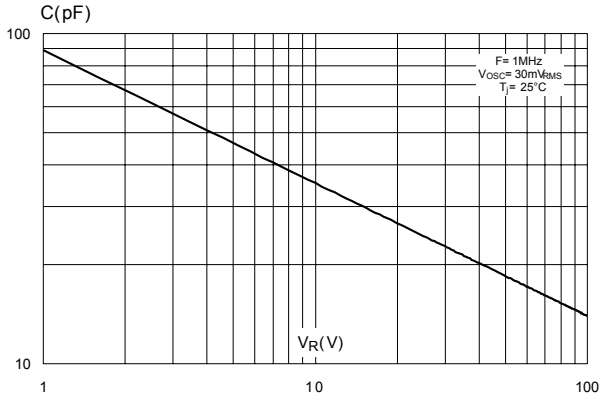

Figure 12. Forward voltage drop versus forward current (low level)

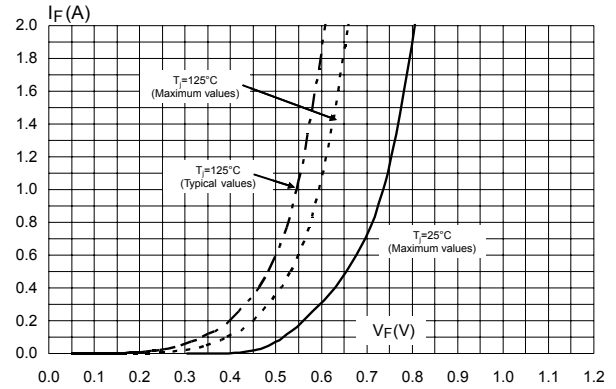

Figure 13. Forward voltage drop versus forward current (high level)

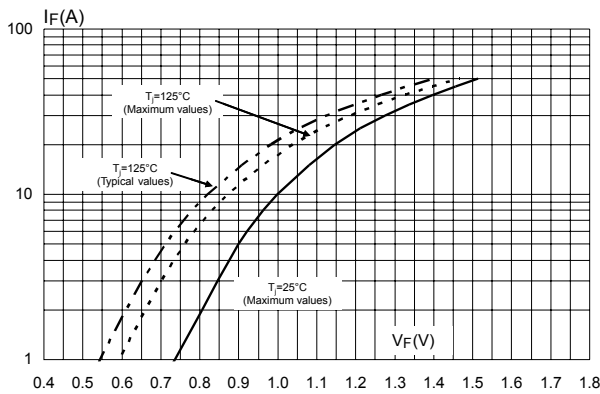

Figure 14. Thermal resistance junction to ambient versus copper surface under each lead (SMA)

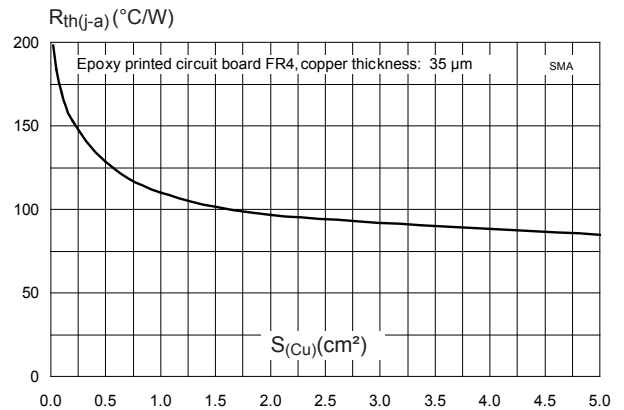

Figure 15. Thermal resistance junction to ambient versus copper surface under each lead (SMA Flat, SMA Flat Notch)

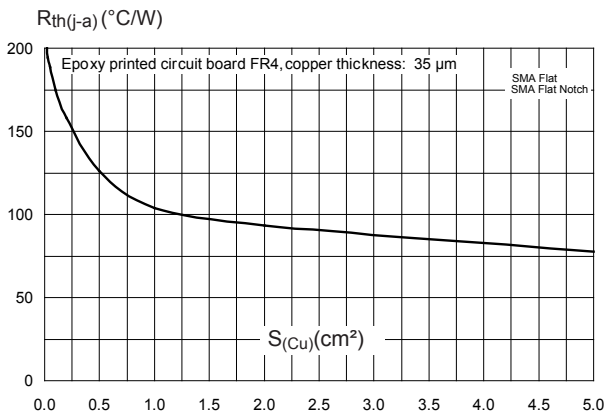

Figure 16. Thermal resistance junction to ambient versus copper surface under each lead (SMB)

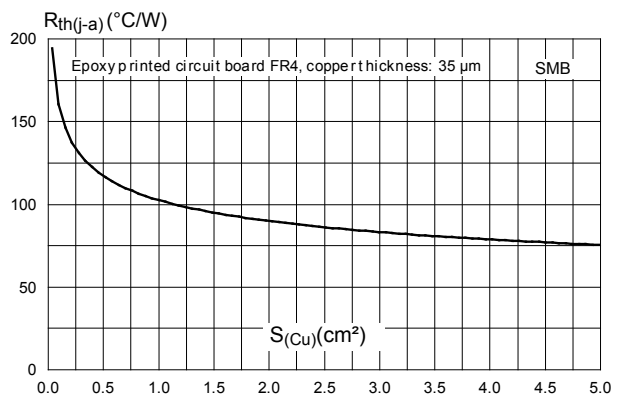
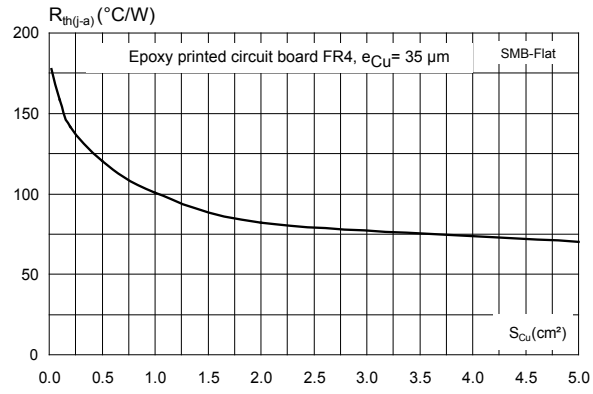

Figure 17. Thermal resistance junction to ambient versus copper surface under each lead (SMB Flat)



2 Package information

In order to meet environmental requirements, ST offers these devices in different grades of **ECOPACK** packages, depending on their level of environmental compliance. ECOPACK specifications, grade definitions and product status are available at: www.st.com. ECOPACK is an ST trademark.

2.1 SMA Flat package information

- Epoxy meets UL94, V0
- Lead-free package

Figure 18. SMA Flat package outline

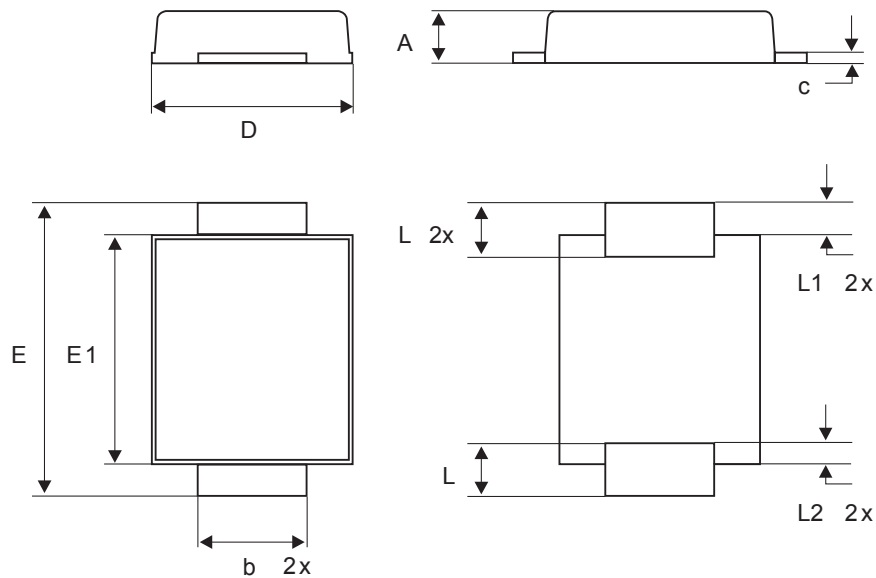
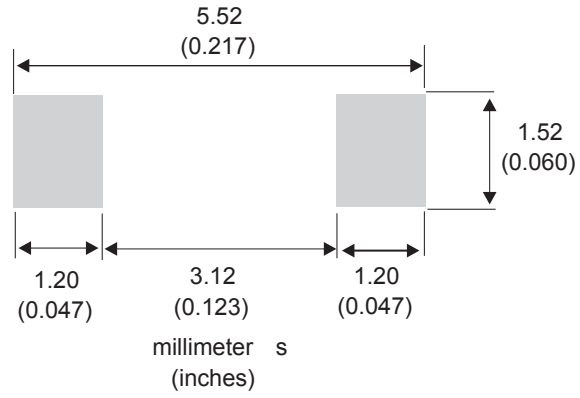

Table 4. SMA Flat package mechanical data

| Ref. | Dimensions | | | | | |
|------|-------------|------|------|-----------------------------|-------|-------|
| | Millimeters | | | Inches (for reference only) | | |
| | Min. | Typ. | Max. | Min. | Typ. | Max. |
| A | 0.90 | | 1.10 | 0.035 | | 0.044 |
| b | 1.25 | | 1.65 | 0.049 | | 0.065 |
| c | 0.15 | | 0.40 | 0.005 | | 0.016 |
| D | 2.25 | | 2.95 | 0.088 | | 0.117 |
| E | 4.80 | | 5.60 | 0.188 | | 0.221 |
| E1 | 3.95 | | 4.60 | 0.155 | | 0.182 |
| L | 0.75 | | 1.50 | 0.029 | | 0.060 |
| L1 | | 0.50 | | | 0.020 | |
| L2 | | 0.50 | | | 0.020 | |

Figure 19. SMA Flat recommended footprint in mm (inches)



2.2 SMA Flat Notch package information

- Epoxy meets UL94, V0
- Cooling method: by conduction (C)
- Band indicates cathode

Figure 20. SMA Flat Notch package outline

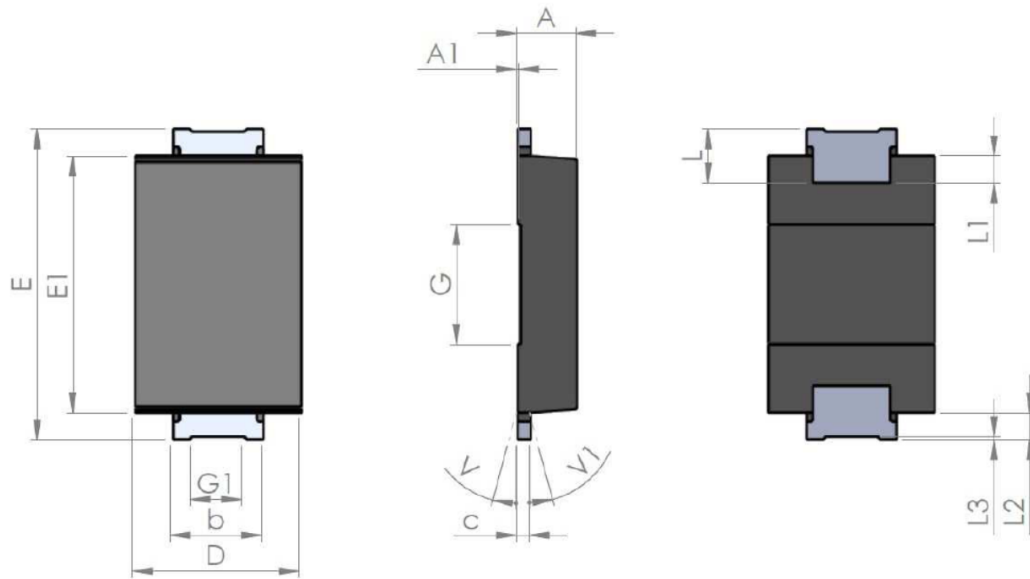
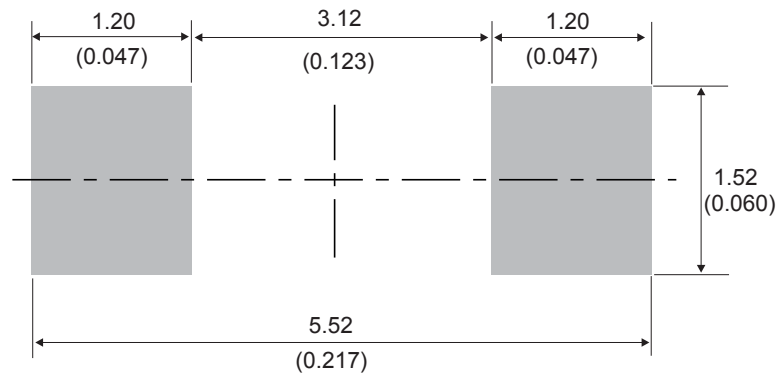

Table 5. SMA Flat Notch package mechanical data

| Ref. | Dimensions | | | | | |
|------|-------------|------|------|-----------------------------|-------|-------|
| | Millimeters | | | Inches (for reference only) | | |
| | Min. | Typ. | Max. | Min. | Typ. | Max. |
| A1 | 0.90 | | 1.10 | 0.035 | | 0.044 |
| A1 | | 0.05 | | | 0.002 | |
| b | 1.25 | | 1.65 | 0.049 | | 0.065 |
| C | 0.15 | | 0.40 | 0.005 | | 0.016 |
| D | 2.25 | | 2.90 | 0.088 | | 0.115 |
| E | 5.00 | | 5.35 | 0.196 | | 0.211 |
| E1 | 3.95 | | 4.60 | 0.155 | | 0.182 |
| G | | 2.00 | | | 0.079 | |
| G1 | | 0.85 | | | 0.033 | |
| L | 0.75 | | 1.20 | 0.029 | | |
| L1 | | 0.45 | | | 0.018 | |
| L2 | | 0.45 | | | 0.018 | |
| L3 | | 0.05 | | | 0.002 | |
| V | | | 8° | | | 8° |
| V1 | | | 8° | | | 8° |

Figure 21. SMA Flat Notch recommended footprint in mm (inches)



2.3 SMA package information

- Epoxy meets UL94, V0
- Lead-free package

Figure 22. SMA package outline

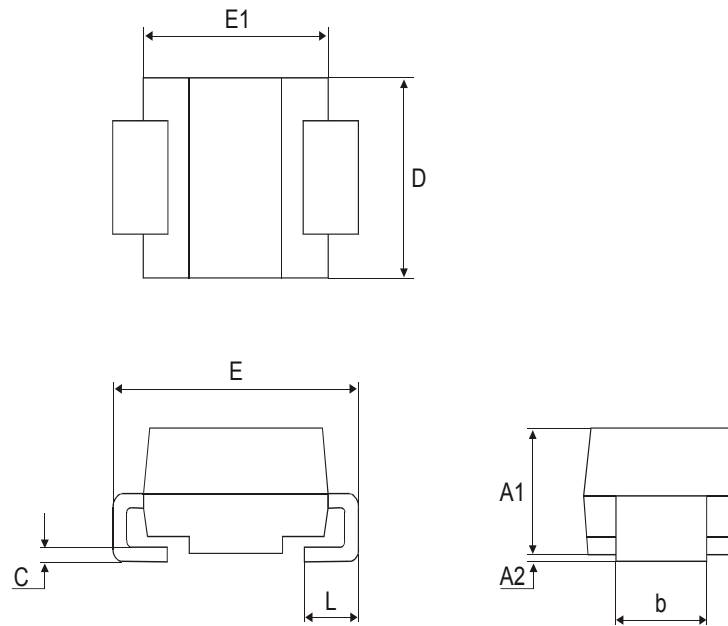
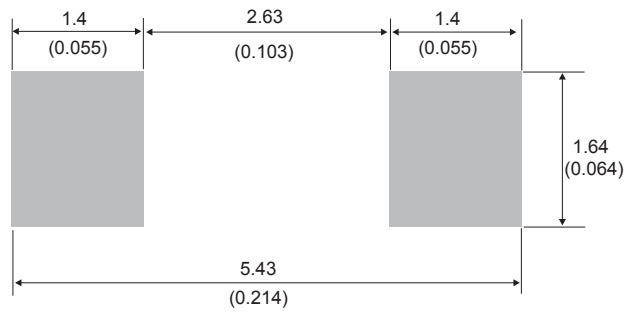

Table 6. SMA package mechanical data

| Ref. | Dimensions | | | |
|------|-------------|------|--------|-------|
| | Millimeters | | Inches | |
| | Min. | Max. | Min. | Max. |
| A1 | 1.90 | 2.45 | 0.075 | 0.097 |
| A2 | 0.05 | 0.20 | 0.002 | 0.008 |
| b | 1.25 | 1.65 | 0.049 | 0.065 |
| c | 0.15 | 0.40 | 0.006 | 0.016 |
| D | 2.25 | 2.90 | 0.089 | 0.114 |
| E | 4.80 | 5.35 | 0.189 | 0.211 |
| E1 | 3.95 | 4.60 | 0.156 | 0.181 |
| L | 0.75 | 1.50 | 0.030 | 0.059 |

Figure 23. SMA recommended footprint in mm (inches)



2.4 SMB package information

- Epoxy meets UL94, V0
- Lead-free package

Figure 24. SMB package outline

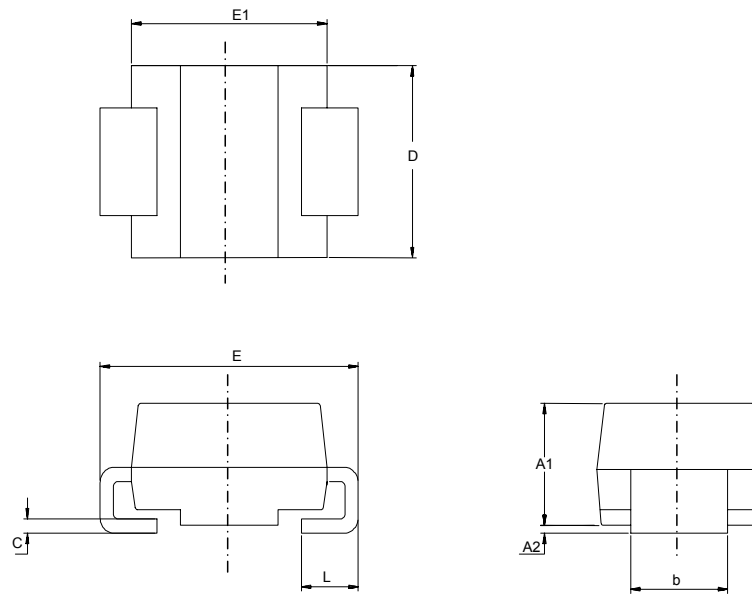
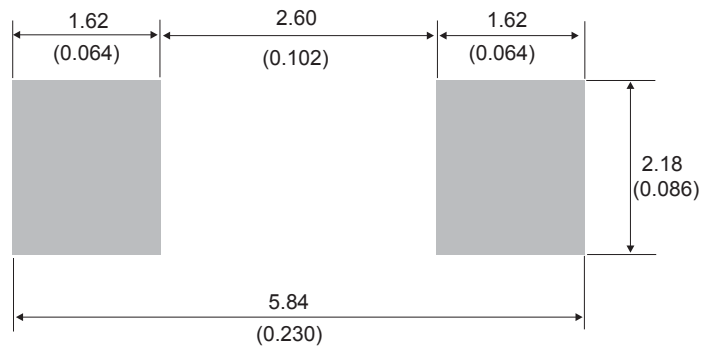

Table 7. SMB package mechanical data

| Ref. | Dimensions | | | |
|------|-------------|------|-----------------------------|--------|
| | Millimeters | | Inches (for reference only) | |
| | Min. | Max. | Min. | Max. |
| A1 | 1.90 | 2.45 | 0.0748 | 0.0965 |
| A2 | 0.05 | 0.20 | 0.0020 | 0.0079 |
| b | 1.95 | 2.20 | 0.0768 | 0.0867 |
| c | 0.15 | 0.40 | 0.0059 | 0.0157 |
| D | 3.30 | 3.95 | 0.1299 | 0.1556 |
| E | 5.10 | 5.60 | 0.2008 | 0.2205 |
| E1 | 4.05 | 4.60 | 0.1594 | 0.1811 |
| L | 0.75 | 1.50 | 0.0295 | 0.0591 |

Figure 25. SMB recommended footprint



2.5 SMB Flat package information

- Epoxy meets UL94, V0
- Lead-free package

Figure 26. SMB Flat package outline

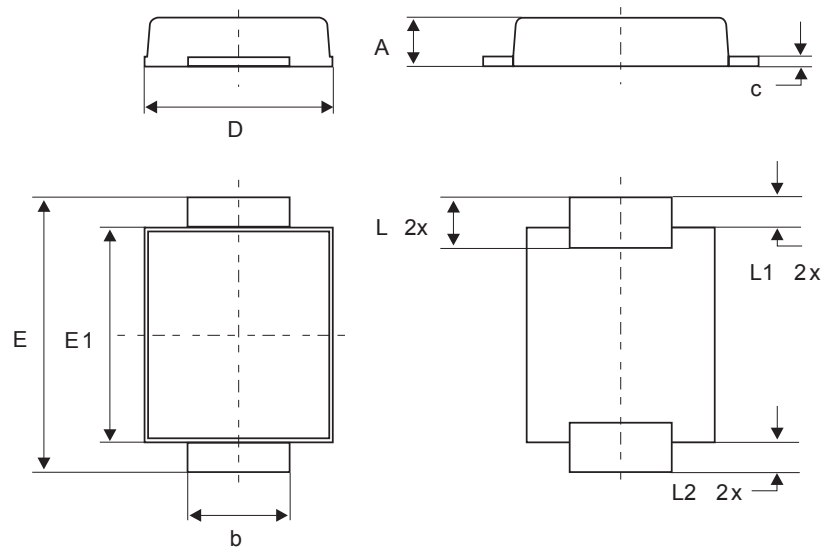
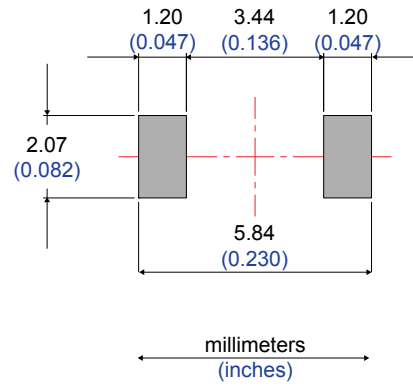

Table 8. SMB Flat mechanical data

| Ref. | Dimensions | | | | | |
|------|-------------|------|------|-----------------------------|-------|-------|
| | Millimeters | | | Inches (for reference only) | | |
| | Min. | Typ. | Max. | Min. | Typ. | Max. |
| A | 0.90 | | 1.10 | 0.035 | | 0.043 |
| b | 1.95 | | 2.20 | 0.077 | | 0.087 |
| c | 0.15 | | 0.40 | 0.006 | | 0.016 |
| D | 3.30 | | 3.95 | 0.130 | | 0.156 |
| E | 5.10 | | 5.60 | 0.201 | | 0.220 |
| E1 | 4.05 | | 4.60 | 0.159 | | 0.181 |
| L | 0.75 | | 1.50 | 0.030 | | 0.059 |
| L1 | | 0.40 | | | 0.016 | |
| L2 | | 0.60 | | | 0.024 | |

Figure 27. Footprint recommendations, dimensions in mm (inches)



3 Ordering Information

Table 9. Ordering information

| Order code | Marking | Package | Weight | Base qty. | Delivery mode |
|--------------|---------|----------------|---------|-----------|---------------|
| STPS2H100A | S21 | SMA | 0.068 g | 5000 | Tape and reel |
| STPS2H100AF | F21 | SMA Flat | 0.035 g | 10 000 | Tape and reel |
| STPS2H100AFN | A21 | SMA Flat Notch | 0.039 g | 10 000 | Tape and reel |
| STPS2H100U | G21 | SMB | 0.107 g | 2500 | Tape and reel |
| STPS2H100UF | FG21 | SMB Flat | 0.050 g | 5000 | Tape and reel |

Revision history

Table 10. Document revision history

| Date | Version | Changes |
|-------------|---------|--|
| Jul-2003 | 4A | Last update. |
| Aug-2004 | 5 | SMA package dimensions update. Reference A1 max. changed from 2.70 (0.106 inches) to 2.03 mm (0.080 inches). |
| 08-Feb-2007 | 6 | Reformatted to current standards. Added ECOPACK statement. Added SMBflat package. |
| 15-Feb-2010 | 7 | Updated weight for SMBflat in Table 9. |
| 24-Jun-2013 | 8 | Added SMAflat package |
| 17-May-2018 | 9 | Removed figure 6. Updated Table 1. Absolute ratings (limiting values at 25 °C, unless otherwise specified) and Section Description. Minor text changes to improve readability. |
| 08-Oct-2019 | 10 | Added Section 2.2 SMA Flat Notch package information. |

IMPORTANT NOTICE – PLEASE READ CAREFULLY

STMicroelectronics NV and its subsidiaries (“ST”) reserve the right to make changes, corrections, enhancements, modifications, and improvements to ST products and/or to this document at any time without notice. Purchasers should obtain the latest relevant information on ST products before placing orders. ST products are sold pursuant to ST’s terms and conditions of sale in place at the time of order acknowledgement.

Purchasers are solely responsible for the choice, selection, and use of ST products and ST assumes no liability for application assistance or the design of Purchasers’ products.

No license, express or implied, to any intellectual property right is granted by ST herein.

Resale of ST products with provisions different from the information set forth herein shall void any warranty granted by ST for such product.

ST and the ST logo are trademarks of ST. For additional information about ST trademarks, please refer to www.st.com/trademarks. All other product or service names are the property of their respective owners.

Information in this document supersedes and replaces information previously supplied in any prior versions of this document.

© 2019 STMicroelectronics – All rights reserved