



















- 1 
- 2 
- 3 
- 4 
- 5 
- 6 
- 7 
- 8 
- 9 
- 10 
- 11 
- 12 
- 13 
- 14 
- 15 
- 16 
- 17 
- 18 

COVERING

Mould-on polyurethane, hardness 95 Shore A.

WHEEL CENTRE BODY

Cast iron.

ROLLING ACTION

Hub with ball bearings. Ideal solution for heavy loads and continuous moving.

FIXED PLATE BRACKET

Electrolytically zinc-plated electro-welded steel. The bracket is designed to withstand loads up to 9000N. Suitable for heavy industrial applications and for severe conditions of use, such as impact and high speeds.

TURNING PLATE BRACKET

Electrolytically zinc-plated electro-welded steel.

The presence of an axial bearing and a conical bearing ensures excellent manoeuvrability also at full load and increases the resistance of the bracket against side impact. It is equipped with lubricator and anti-loosening system of the locking nut. The bracket is designed to withstand loads up to 9000N. Suitable for heavy industrial applications and for severe conditions of use, such as impact and high speeds.

It consists of (see Fig.1):

1. fitting plate: forged steel with built-in pin, electrolytically zinc-plated;
2. fork: drawn sides electro-welded to the flange, electrolytically zinc-plated;
3. rotation system: axial ball bearing and conical roller bearing;
4. lubricator
5. anti-loosening system of the locking nut.

BRAKE

Dual-effect rear brake with simultaneous locking of wheel and bracket. The brake is simple and effective to use: it is actuated and released by a simple action from the top downward at the tip of two separate pedals, thus ensuring the utmost manoeuvring comfort. The braking efficacy may be adjusted with a socket head screw M8.

STANDARD EXECUTIONS

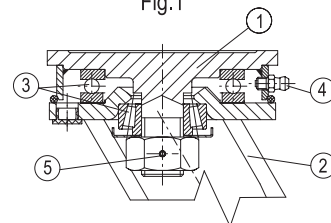
- PSL-WH: fixed plate bracket, without brake.
- SSL-WH: turning plate bracket, without brake.
- SSF-WH: turning plate bracket, with brake.

APPLICATIONS

Suitable for heavy industrial applications and severe conditions of use. The mould-on polyurethane wheels ensure excellent rolling resistance and elasticity, high wear and tearing resistance. For further information see wheel technical data sheet RE.F4 (see page 1834).

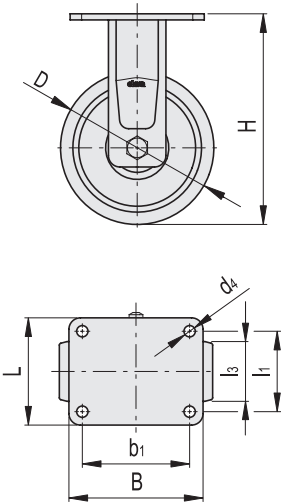


Fig.1

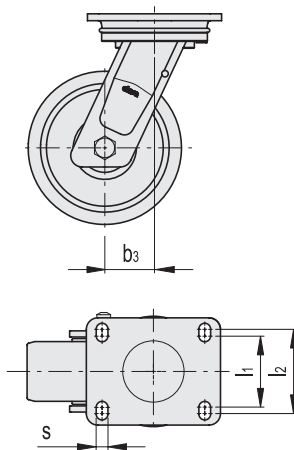


Conversion Table	
1 mm = 0.039 inch	
D	
mm	inch
125	4.92
160	6.30
200	7.87

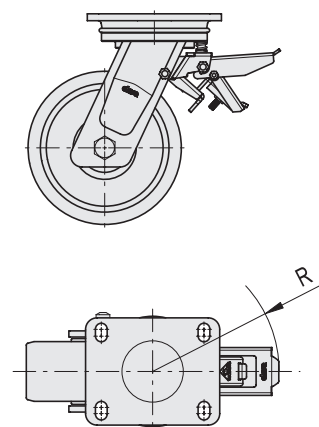
RE.F4-PSL-WH



RE.F4-SSL-WH



RE.F4-SSF-WH



METRIC

Code	Description	D	d4	l1	l2	l3	H	B	L	s	b1	b3	R	Rolling resistance# [N]	Dynamic carrying capacity# [N]	⚖️
451465	RE.F4-125-PSL-WH	125	11	80	-	50	182	135	110	-	105	-	-	2700	5500	3900
451466	RE.F4-150-PSL-WH	150	11	80	-	50	210	135	110	-	105	-	-	2900	7000	4510
451467	RE.F4-200-PSL-WH	200	11	80	-	50	252	135	110	-	105	-	-	3800	9000	5790
451425	RE.F4-125-SSL-WH	125	-	73	87	50	182	135	110	11	105	51	-	2700	5500	4880
451426	RE.F4-150-SSL-WH	150	-	73	87	50	210	135	110	11	105	60	-	2900	7000	5500
451427	RE.F4-200-SSL-WH	200	-	73	87	50	252	135	110	11	105	70	-	3800	9000	6770
451446	RE.F4-125-SSF-WH	125	-	73	87	50	182	135	110	11	105	51	157	2700	5500	5760
451447	RE.F4-150-SSF-WH	150	-	73	87	50	210	135	110	11	105	60	157	2900	7000	6380
451448	RE.F4-200-SSF-WH	200	-	73	87	50	252	135	110	11	105	70	157	3800	9000	7650

For rolling resistance and dynamic carrying capacity see Technical data (on page 1880).

