

Three-PLL Programmable Clock Generator with Spread Spectrum

Features

- Three fully integrated phase-locked loops (PLLs)
 - Input frequency range
 - External crystal: 8 to 48 MHz
 - External reference: 8 to 166 MHz clock
 - Reference clock input voltage range
 - 2.5 V, 3.0 V, and 3.3 V for CY25483
 - 1.8 V for CY25403 and CY25423
 - Wide operating output frequency range
 - 3 to 166 MHz
 - Programmable spread spectrum with center and down spread option and lexmark and linear modulation profiles
 - V_{DD} supply voltage options
 - 2.5 V, 3.0 V, and 3.3 V for CY25403 and CY25483
 - 1.8 V for CY25423
 - Frequency select feature with option to select four different frequencies
 - Power-down, output enable, and SS ON/OFF controls
 - Low jitter, high accuracy outputs
 - Ability to synthesize nonstandard frequencies with Fractional-N capability
 - Three clock outputs with programmable drive strength
 - Glitch-free outputs while frequency switching

- 8-pin SOIC package
- Commercial and Industrial temperature ranges
- One-time programmability
 - For programming support, contact [Cypress technical support](#) or send an e-mail to clocks@cypress.com

Benefits

- Multiple high-performance PLLs allow synthesis of unrelated frequencies
- Nonvolatile programming for personalization of PLL frequencies, spread spectrum characteristics, drive strength, crystal load capacitance, and output frequencies
- Application specific programmable EMI reduction using Spread Spectrum for clocks
- Programmable PLLs for system frequency margin tests
- Meets critical timing requirements in complex system designs
- Suitability for PC, consumer, portable, and networking applications
- Capable of Zero PPM frequency synthesis error
- Uninterrupted system operation during clock frequency switch
- Application compatibility in standard and low-power systems

Functional Description

For a complete list of related documentation, click [here](#).

Block Diagram

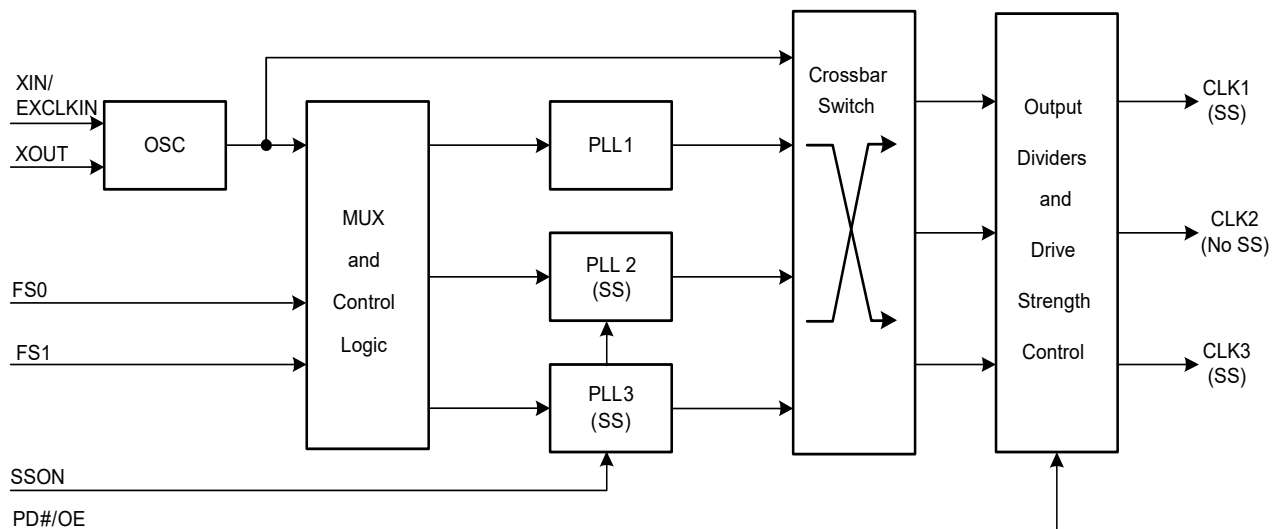

Contents

Device Selector Guide	3	Recommended Crystal Specification	8
Pin Configuration	3	Recommended Crystal Specification	8
Pin Definitions	3	Test and Measurement Setup	9
Functional Overview	4	Voltage and Timing Definitions	9
Configurable PLLs	4	Ordering Information	10
Input Reference Clocks	4	Possible Configurations	10
VDD Power Supply Options	4	Ordering Code Definitions	11
Spread Spectrum Control	4	Package Drawing and Dimensions	12
Frequency Select	4	Acronyms	13
Glitch-Free Frequency Switch	4	Document Conventions	13
PD#/OE Mode	4	Units of Measure	13
Output Drive Strength	4	Document History Page	14
Generic Configuration and Custom Frequency	4	Sales, Solutions, and Legal Information	16
Absolute Maximum Conditions	5	Worldwide Sales and Design Support	16
Recommended Operating Conditions	5	Products	16
DC Electrical Specifications	6	PSoC® Solutions	16
Thermal Resistance	6	Cypress Developer Community	16
AC Electrical Specifications	7	Technical Support	16
Configuration Example	8		

Device Selector Guide

Device	Crystal Input	EXCLKIN Input	V _{DD}
CY25403	Yes	1.8 V LVCMOS	2.5 V, 3.0 V, 3.3 V
CY25483	No	2.5 V, 3.0 V, 3.3 V LVCMOS	2.5 V, 3.0 V, 3.3 V
CY25423	Yes	1.8 V LVCMOS	1.8 V

Pin Configuration

Figure 1. 8-pin SOIC pinout

CY25403/CY25423/CY25483

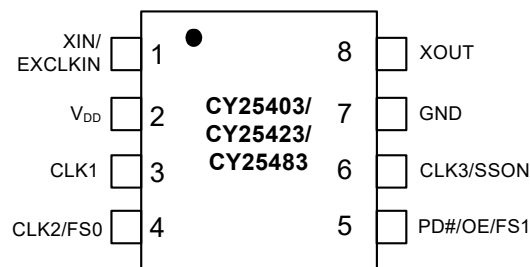

Pin Definitions

CY25403/CY25423/CY25483

Pin Number	Name	IO	Description
1	XIN/EXCLKIN	Input	Crystal input or external clock input (Refer Device Selector Guide on page 3)
2	V _{DD}	Power	Power supply (Refer Device Selector Guide on page 3)
3	CLK1	Output	Programmable clock output with spread spectrum
4	CLK2/FS0	Output/Input	Multifunction programmable pin: programmable clock output with no spread spectrum or frequency select pin
5	PD#/OE/FS1	Input	Multifunction programmable pin: power-down, output enable, or frequency select pin
6	CLK3/SSON	Output/Input	Multifunction programmable pin: programmable clock output with spread spectrum or spread spectrum ON/OFF control pin
7	GND	Power	Power supply ground
8	XOUT	Output	Crystal output

Functional Overview

Configurable PLLs

The CY25403/CY25423/CY25483 have three programmable PLLs that can be used to generate output frequencies ranging from 3 to 166 MHz. The advantage of having three PLLs is that a single device generates up to three independent frequencies from a single crystal.

Input Reference Clocks

The input reference clock can be either a crystal or a clock signal, for CY25403 and CY25423 while just a clock signal for CY25483. The input frequency range for crystal (XIN) is 8 MHz to 48 MHz and that for external reference clock (EXCLKIN) is 8 MHz to 166 MHz. The voltage range of the reference clock input for CY25483 is 2.5 V/3.0 V/3.3 V while that for CY25403 and CY25423 is 1.8 V. This gives user an option for this device to be compatible for different input clock voltage levels in the system.

V_{DD} Power Supply Options

These devices have programmable power supply options. The CY25403/CY25483 is a high voltage part that can be programmed to operate at any voltage 2.5 V, 3.0 V, or 3.3 V while CY25423 is a low voltage part that can operate at 1.8 V.

These devices have programmable input sources for each of its clock outputs. There are four available clock sources and these clock sources are: XIN/EXCLKIN, PLL1, PLL2, and PLL3. Output clock source selection is done by using four out of four crossbar switch. Thus, any one of these four available clock sources can be arbitrarily selected for the clock outputs. This gives user a flexibility to have up to three independent clock outputs.

Spread Spectrum Control

Two of the three PLLs (PLL2 and PLL3) have spread spectrum capability for EMI reduction in the system. The device uses a Cypress proprietary PLL and spread spectrum clock (SSC) technology to synthesize and modulate the frequency of the PLL. The spread spectrum feature can be turned on or off using a multifunction control pin (CLK3/SSON). It can be programmed to either center spread range from $\pm 0.125\%$ to $\pm 2.50\%$ or down spread range from -0.25% to -5.0% with Lexmark or Linear profile.

Frequency Select

Each PLL can be programmed for up to four different frequencies. There are two multifunction programmable pins, CLK2/FS0 and PD#/OE/FS1 which if programmed as frequency select inputs, can be used to select among these arbitrarily programmed frequency settings. Each output has programmable output divider options.

Glitch-Free Frequency Switch

When the frequency select pin, FS(1:0) is used to switch frequency, the outputs are glitch-free provided frequency is switched using output dividers. This feature enables uninterrupted system operation while clock frequency is being switched.

PD#/OE Mode

Multifunction pin PD#/OE/FS1 (Pin 5) can be programmed to operate as either frequency select (FS1), power-down (PD#) or output enable (OE) mode. PD# is a low-true input. If activated it shuts off the entire chip, resulting in minimum power consumption for the device. Setting this signal high brings the device in the operational mode with default register settings.

When this pin is programmed as output enable (OE), clock outputs can be enabled or disabled using OE (pin 5). Individual clock outputs can be programmed to be sensitive to this OE pin.

Output Drive Strength

The DC drive strength of the individual clock output can be programmed for different values. Table 1 shows the typical rise and fall times for different drive strength settings.

Table 1. Output Drive Strength

Output Drive Strength	Rise/Fall Time (ns) (Typical Value)
Low	6.8
Mid Low	3.4
Mid High	2.0
High	1.0

Generic Configuration and Custom Frequency

There is a generic set of output frequencies available from the factory that can be used for the device evaluation purposes. The device, CY25403/CY25423/CY25483 can be custom programmed to any desired frequencies and listed features. For customer specific programming, contact your local Cypress Field Application Engineer (FAE) or sales representative.

Absolute Maximum Conditions

Parameter	Description	Condition	Min	Max	Unit
V _{DD}	Supply voltage for CY25403/CY25483	–	–0.5	4.5	V
	Supply voltage for CY25423	–	–0.5	2.6	
V _{IN}	Input voltage for CY25403/CY25423/CY25483	Relative to V _{SS}	–0.5	V _{DD} + 0.5	V
T _S	Temperature, Storage	Non Functional	–65	+150	°C
ESD _{HBM}	ESD protection (human body model)	JEDEC EIA/JESD22-A114-E	2000		Volts
UL-94	Flammability rating	V-0 at 1/8 in.	–	10	ppm
MSL	Moisture sensitivity level	SOIC package		–3	–

Recommended Operating Conditions

Parameter	Description	Min	Typ	Max	Unit
V _{DD}	V _{DD} operating voltage for CY25403/CY25483	2.25	–	3.60	V
	V _{DD} operating voltage for CY25423	1.65	1.8	1.95	
T _{AC}	Commercial ambient temperature	0	–	+70	°C
T _{AI}	Industrial ambient temperature	–40	--	+85	°C
C _{LOAD}	Maximum load capacitance	–	–	15	pF
t _{PU}	Power-up time for all V _{DD} to reach minimum specified voltage (power ramps must be monotonic)	0.05	–	500	ms

DC Electrical Specifications

Parameter	Description	Conditions	Min	Typ	Max	Unit
V _{OL}	Output low voltage	I _{OL} = 2 mA, drive strength = [00]	–	–	0.4	V
		I _{OL} = 3 mA, drive strength = [01]				
		I _{OL} = 7 mA, drive strength = [10]				
		I _{OL} = 12 mA, drive strength = [11]				
V _{OH}	Output high voltage	I _{OH} = –2 mA, drive strength = [00]	V _{DD} – 0.4	–	–	V
		I _{OH} = –3 mA, drive strength = [01]				
		I _{OH} = –7 mA, drive strength = [10]				
		I _{OH} = –12 mA, drive strength = [11]				
V _{IL1}	Input low voltage of PD#/OE, FS0, FS1 and SSON		–	–	0.2 × V _{DD}	V
V _{IL2}	Input low voltage of EXCLKIN for CY25403/CY25423		–	–	0.3	V
V _{IL3}	Input low voltage of EXCLKIN for CY25483		–	–	0.2 × V _{DD}	V
V _{IH1}	Input high voltage of PD#/OE, FS0, FS1 and SSON		0.8 × V _{DD}	–	–	V
V _{IH2}	Input high voltage of EXCLKIN for CY25403/CY25483		1.62	–	2.2	V
V _{IH3}	Input high voltage of EXCLKIN for CY25423		0.8 × V _{DD}	–	–	V
I _{IL}	Input low current, PD#/OE/FS1	V _{IN} = 0 V	–	–	10	μA
I _{IH}	Input high current, PD#/OE/FS1	V _{IN} = V _{DD}	–	–	10	μA
I _{ILDN}	Input low current, SSON and FS0 pins	V _{IN} = 0 V (Internal pull-down resistor = 160k typ.)	–	–	10	μA
I _{IHDN}	Input high current, SSON and FS0 pins	V _{IN} = V _{DD} (Internal pull-down resistor = 160k typ.)	14	–	36	μA
R _{DN}	Pull-down resistor of CLK1, CLK2/FS0 and CLK3/SSON pins	Output clocks in off state by setting PD# = Low	100	160	250	kΩ
I _{DD} ^[1, 2]	Supply current for CY25403/CY25423/CY25483	PD# = High, No load	–	22	–	mA
I _{DDS} ^[1]	Standby current	PD# = Low	–	3	–	μA
C _{IN} ^[1]	Input capacitance	SSON, PD#/OE/FS1 and FS0 pins	–	–	7	pF

Thermal Resistance

Parameter ^[3]	Description	Test Conditions	8-pin SOIC	Unit
θ _{JA}	Thermal resistance (junction to ambient)	Test conditions follow standard test methods and procedures for measuring thermal impedance, in accordance with EIA/JESD51.	131	°C/W
θ _{JC}	Thermal resistance (junction to case)		40	°C/W

Notes

1. Guaranteed by design but not 100% tested.
2. Configuration dependent.
3. These parameters are guaranteed by design and are not tested.

AC Electrical Specifications

Parameter	Description	Conditions	Min	Typ	Max	Unit
F _{IN} (crystal)	Crystal frequency, XIN	–	8	–	48	MHz
F _{IN} (clock)	Input clock frequency (EXCLKIN)	–	8	–	166	MHz
F _{CLK}	Output clock frequency	–	3	–	166	MHz
DC	Output duty cycle, all clocks except ref out	Duty Cycle is defined in Figure 3 on page 9 ; t ₁ /t ₂ , measured at 50% of V _{DD}	45	50	55	%
DC	Ref out duty cycle	Ref In Min 45%, Max 55%	40	–	60	%
T _{RF1} ^[4]	Output rise/fall time	Measured from 20% to 80% of V _{DD} , as shown in Figure 4 on page 9 , CL = 15 pF, drive strength [00]	–	6.8	–	ns
T _{RF2} ^[4]	Output rise/fall time	Measured from 20% to 80% of V _{DD} , as shown in Figure 4 on page 9 , CL = 15 pF, drive strength [01]	–	3.4	–	ns
T _{RF3} ^[4]	Output rise/fall time	Measured from 20% to 80% of V _{DD} , as shown in Figure 4 on page 9 , CL = 15 pF, drive strength [10]	–	2.0	–	ns
T _{RF4} ^[4]	Output rise/fall time	Measured from 20% to 80% of V _{DD} , as shown in Figure 4 on page 9 , CL = 15 pF, drive strength [11]	–	1.0	–	ns
T _{CCJ} ^[4, 5]	Cycle-to-cycle jitter (peak)	Configuration dependent. See Configuration Example on page 8	–	100	–	ps
T _{LOCK} ^[4]	PLL lock time	Measured from 90% of the applied power supply level	–	1	3	ms

Notes

4. Guaranteed by design but not 100% tested.
5. Configuration dependent.

Configuration Example

For C-C Jitter

Ref. Frequency (MHz)	CLK1 Output		CLK2 Output		CLK3 Output	
	Freq. (MHz)	C-C Jitter Typ (ps)	Freq. (MHz)	C-C Jitter Typ (ps)	Freq. (MHz)	C-C Jitter Typ (ps)
14.3181	8.0	134	166	103	48	92
19.2	74.25	99	166	94	8	91
27	48	67	27	109	166	103
48	48	93	27	123	166	137

Recommended Crystal Specification

For SMD Package

Parameter	Description	Range 1	Range 2	Range 3	Unit
Fmin	Minimum frequency	8	14	28	MHz
Fmax	Maximum frequency	14	28	48	MHz
R1	Motional resistance (ESR)	135	50	30	Ω
C0	Shunt capacitance	4	4	2	pF
CL	Parallel load capacitance	18	14	12	pF
DL(max)	Maximum crystal drive level	300	300	300	μ W

Recommended Crystal Specification

For Thru-Hole Package

Parameter	Description	Range 1	Range 2	Range 3	Unit
Fmin	Minimum frequency	8	14	24	MHz
Fmax	Maximum frequency	14	24	32	MHz
R1	Motional resistance (ESR)	90	50	30	Ω
C0	Shunt capacitance	7	7	7	pF
CL	Parallel load capacitance	18	12	12	pF
DL(max)	Maximum crystal drive level	1000	1000	1000	μ W

Test and Measurement Setup

Figure 2. Test and Measurement Setup

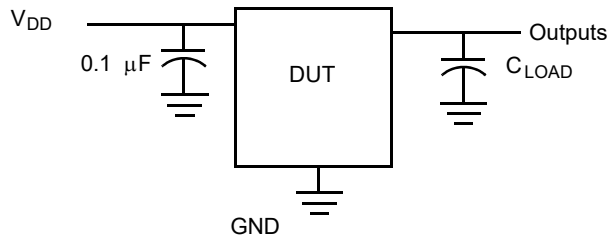

Voltage and Timing Definitions

Figure 3. Duty Cycle Definition

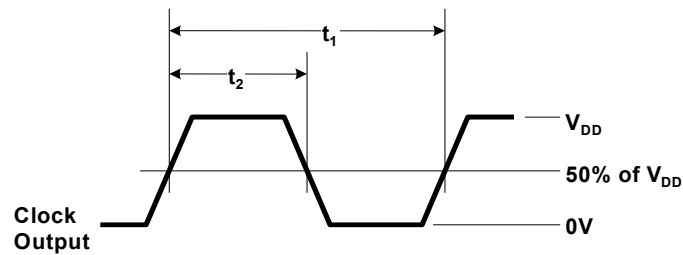
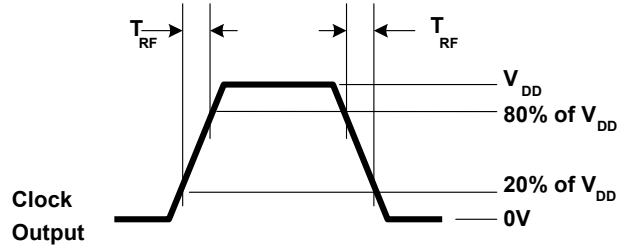

Figure 4. Rise Time = T_{RF} , Fall Time = T_{RF}



Ordering Information

Part Number	Type	Package	Supply Voltage	Production Flow
Pb-free				
CY25403SXC	Field Programmable	8-pin SOIC	2.5 V, 3.0 V, or 3.3 V	Commercial, 0 °C to 70 °C
CY25403SXCT	Field Programmable	8-pin SOIC – Tape and Reel	2.5 V, 3.0 V, or 3.3 V	Commercial, 0 °C to 70 °C
CY25423SXC	Field Programmable	8-pin SOIC	1.8 V	Commercial, 0 °C to 70 °C
CY25423SXCT	Field Programmable	8-pin SOIC – Tape and Reel	1.8 V	Commercial, 0 °C to 70 °C
CY25483SXC	Field Programmable	8-pin SOIC	2.5 V, 3.0 V, or 3.3 V	Commercial, 0 °C to 70 °C
CY25483SXCT	Field Programmable	8-pin SOIC – Tape and Reel	2.5 V, 3.0 V, or 3.3 V	Commercial, 0 °C to 70 °C
CY25403SXI	Field Programmable	8-pin SOIC	2.5 V, 3.0 V, or 3.3 V	Industrial, –40 °C to +85 °C
CY25403SXIT	Field Programmable	8-pin SOIC – Tape and Reel	2.5 V, 3.0 V, or 3.3 V	Industrial, –40 °C to +85 °C
CY25423SXI	Field Programmable	8-pin SOIC	1.8 V	Industrial, –40 °C to +85 °C
CY25423SXIT	Field Programmable	8-pin SOIC – Tape and Reel	1.8 V	Industrial, –40 °C to +85 °C
CY25483SXI	Field Programmable	8-pin SOIC	2.5 V, 3.0 V, or 3.3 V	Industrial, –40 °C to +85 °C
CY25483SXIT	Field Programmable	8-pin SOIC – Tape and Reel	2.5 V, 3.0 V, or 3.3 V	Industrial, –40 °C to +85 °C
Programmer				
CY3675-CLKMAKER1	Programming Kit			
CY3675-SOIC8A	Socket Adapter Board, for programming CY25402, CY25403, CY25422, CY25423, CY25482, and CY25483			

Some product offerings are factory programmed customer specific devices with customized part numbers. The [Possible Configurations](#) table shows the available device types, but not complete part numbers. Contact your local Cypress FAE or sales representative for more information.

Possible Configurations

Part Number ^[6]	Type	V _{DD} (V)	Production Flow
Pb-free			
CY25403/CY25423/CY25483SXC-xxx	8-pin SOIC	Supply Voltage: 2.5 V, 3.0 V, or 3.3 V	Commercial, 0 °C to 70 °C
CY25403/CY25423/CY25483SXC-xxxT	8-pin SOIC – Tape and Reel	Supply Voltage: 2.5 V, 3.0 V, or 3.3 V	Commercial, 0 °C to 70 °C
CY25403/CY25423/CY25483SXI-xx	8-pin SOIC	Supply Voltage: 2.5 V, 3.0 V, or 3.3 V	Industrial, –40 °C to +85 °C
CY25403/CY25423/CY25483SXI-xxT	8-pin SOIC – Tape and Reel	Supply Voltage: 2.5 V, 3.0 V, or 3.3 V	Industrial, –40 °C to +85 °C

Note

6. xxx indicates factory programmed parts based on customer specific configuration. For more details, contact your local Cypress FAE or sales representative.

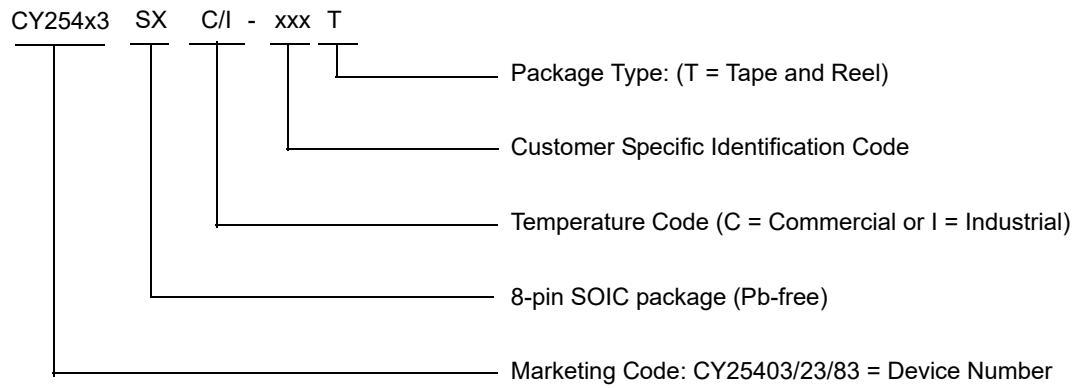
Ordering Code Definitions

Package Drawing and Dimensions

Figure 5. 8-pin SOIC (150 Mils) S0815/SZ815/SW815 Package Outline, 51-85066

1. DIMENSIONS IN INCHES[MM] MIN. MAX.
2. PIN 1 ID IS OPTIONAL, ROUND ON SINGLE LEADFRAME RECTANGULAR ON MATRIX LEADFRAME
3. REFERENCE JEDEC MS-012
4. PACKAGE WEIGHT 0.07gms

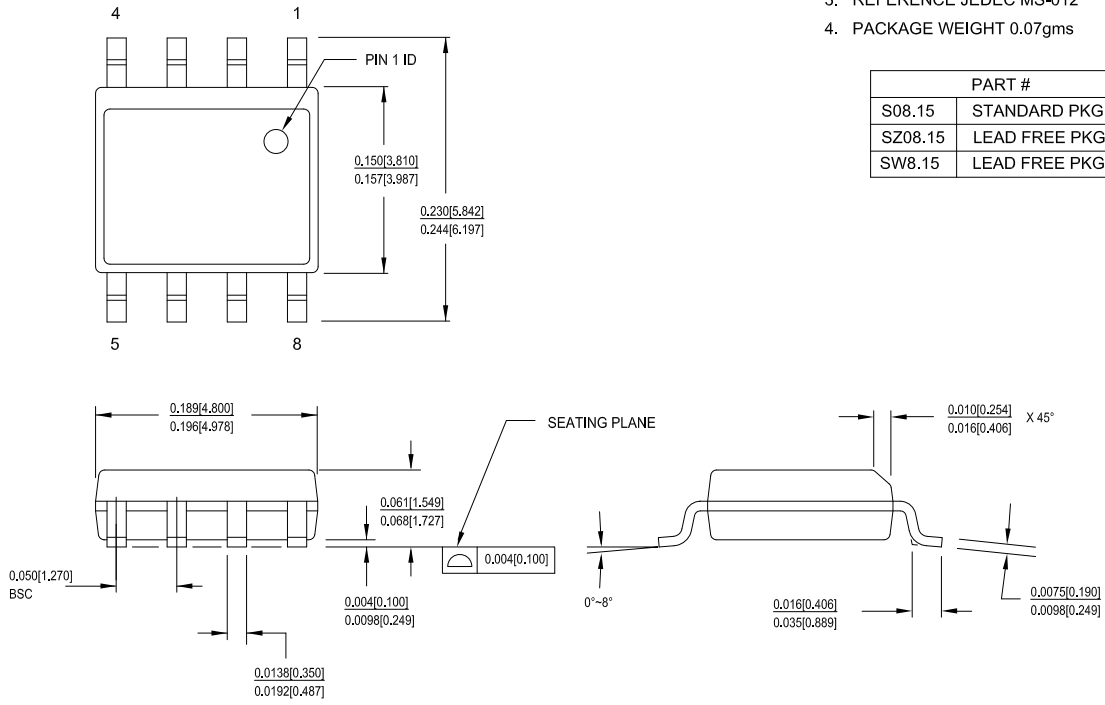

51-85066 *I

Acronyms

Acronym	Description
DL	drive level
DNU	do not use
DUT	device under test
EIA	Electronic Industries Alliance
EMI	electromagnetic interference
ESD	electrostatic discharge
FAE	field application engineer
FS	frequency select
JEDEC	Joint Electron Devices Engineering Council
LVC MOS	low voltage complementary metal oxide semiconductor
OE	output enable
OSC	oscillator
PD	power-down
PLL	phase-locked loop
PPM	parts per million
SS	spread spectrum
SSC	spread spectrum clock
SSON	spread spectrum on

Document Conventions

Units of Measure

Symbol	Unit of Measure
°C	degree Celsius
MHz	megahertz
μA	microampere
mA	milliampere
ms	millisecond
ns	nanosecond
pF	picofarad
ps	picosecond
V	volt

Document History Page

Document Title: CY25403/CY25423/CY25483, Three-PLL Programmable Clock Generator with Spread Spectrum Document Number: 001-12564				
Rev.	ECN No.	Orig. of Change	Submission Date	Description of Change
**	690296	RGL	01/17/2007	New data sheet.
*A	815788	RGL	03/02/2007	Minor Change: To post on web.
*B	1428744	RGL / AESA	08/30/2007	Updated Document Title to read as "CY25403/CY25423/CY25483 Three PLL Programmable Clock Generator with Spread Spectrum". Changed status from Preliminary to Final. Added CY25483 part related information in all instances across the document. Updated Block Diagram . Updated Pin Definitions: Updated details in "Description" column. Updated Functional Overview : Updated description and added sub-sections. Updated Absolute Maximum Conditions : Updated details corresponding to V_{DD} and V_{IN} parameters. Updated Recommended Operating Conditions : Updated details corresponding to V_{DD} parameter. Updated DC Electrical Specifications : Updated almost entire table. Updated Ordering Information : Updated part numbers.
*C	2748211	TSAI	08/10/2009	Post to external web.
*D	2899300	CXQ	03/25/2010	Updated Ordering Information : Added Possible Configurations . Added Note 6 and referred the same note in "Part Number" column. Updated Package Drawing and Dimensions : spec 51-85066 – Changed revision from *C to *D.
*E	2898568	CXQ	06/02/2010	Updated Ordering Information : Updated part numbers. Added Ordering Code Definitions . Added Acronyms . Updated to new template.
*F	3319132	BASH	07/18/2011	Updated Package Drawing and Dimensions : spec 51-85066 – Changed revision from *D to *E. Added Units of Measure . Updated to new template.

Document History Page *(continued)*

Document Title: CY25403/CY25423/CY25483, Three-PLL Programmable Clock Generator with Spread Spectrum Document Number: 001-12564				
Rev.	ECN No.	Orig. of Change	Submission Date	Description of Change
*G	4468493	TAVA	08/12/2014	Updated Features : Updated details under “Reference clock input voltage range”, “V _{DD} supply voltage options:”, and “Selectable output clock voltages independent of V _{DD} supply:”. Updated Device Selector Guide : Updated details in “Crystal Input”, “EXCLKIN Input” and “V _{DD} ” columns. Updated Pin Definitions : Updated details in “Description” column corresponding to pin numbers 1 and 2. Updated Functional Overview : Updated Input Reference Clocks : Updated description. Updated VDD Power Supply Options : Updated description. Updated Absolute Maximum Conditions : Updated details corresponding to V _{DD} parameter. Updated Recommended Operating Conditions : Updated details corresponding to V _{DD} parameter. Updated DC Electrical Specifications : Updated details corresponding to V _{IH2} parameter. Added V _{IH3} parameter and its details. Updated Package Drawing and Dimensions : spec 51-85066 – Changed revision from *E to *F. Updated to new template. Completing Sunset Review.
*H	4586478	TAVA	12/03/2014	Updated Functional Description : Added “For a complete list of related documentation, click here .” at the end.
*I	5279365	PSR	05/20/2016	Added Thermal Resistance . Updated Package Drawing and Dimensions : spec 51-85066 – Changed revision from *F to *H. Updated to new template. Completing Sunset Review.
*J	5778174	PSR	06/19/2017	Updated Features : Added one-time programmability.
*K	5952739	XHT	10/31/2017	Updated DC Electrical Specifications : Updated details in “Description” and “Max” columns corresponding to V _{IL2} parameter. Added V _{IL3} parameter and its details. Updated Package Drawing and Dimensions : spec 51-85066 – Changed revision from *H to *I. Updated to new template.

Sales, Solutions, and Legal Information

Worldwide Sales and Design Support

Cypress maintains a worldwide network of offices, solution centers, manufacturers' representatives, and distributors. To find the office closest to you, visit us at [Cypress Locations](#).

Products

ARM [®] Cortex [®] Microcontrollers	cypress.com/arm
Automotive	cypress.com/automotive
Clocks & Buffers	cypress.com/clocks
Interface	cypress.com/interface
Internet of Things	cypress.com/iot
Memory	cypress.com/memory
Microcontrollers	cypress.com/mcu
PSoC	cypress.com/psoc
Power Management ICs	cypress.com/pmic
Touch Sensing	cypress.com/touch
USB Controllers	cypress.com/usb
Wireless Connectivity	cypress.com/wireless

PSoC[®] Solutions

[PSoC 1](#) | [PSoC 3](#) | [PSoC 4](#) | [PSoC 5LP](#) | [PSoC 6](#)

Cypress Developer Community

[Forums](#) | [WICED IOT Forums](#) | [Projects](#) | [Video](#) | [Blogs](#) | [Training](#) | [Components](#)

Technical Support

cypress.com/support

© Cypress Semiconductor Corporation, 2007-2017. This document is the property of Cypress Semiconductor Corporation and its subsidiaries, including Spansion LLC ("Cypress"). This document, including any software or firmware included or referenced in this document ("Software"), is owned by Cypress under the intellectual property laws and treaties of the United States and other countries worldwide. Cypress reserves all rights under such laws and treaties and does not, except as specifically stated in this paragraph, grant any license under its patents, copyrights, trademarks, or other intellectual property rights. If the Software is not accompanied by a license agreement and you do not otherwise have a written agreement with Cypress governing the use of the Software, then Cypress hereby grants you a personal, non-exclusive, nontransferable license (without the right to sublicense) (1) under its copyright rights in the Software (a) for Software provided in source code form, to modify and reproduce the Software solely for use with Cypress hardware products, only internally within your organization, and (b) to distribute the Software in binary code form externally to end users (either directly or indirectly through resellers and distributors), solely for use on Cypress hardware product units, and (2) under those claims of Cypress's patents that are infringed by the Software (as provided by Cypress, unmodified) to make, use, distribute, and import the Software solely for use with Cypress hardware products. Any other use, reproduction, modification, translation, or compilation of the Software is prohibited.

TO THE EXTENT PERMITTED BY APPLICABLE LAW, CYPRESS MAKES NO WARRANTY OF ANY KIND, EXPRESS OR IMPLIED, WITH REGARD TO THIS DOCUMENT OR ANY SOFTWARE OR ACCOMPANYING HARDWARE, INCLUDING, BUT NOT LIMITED TO, THE IMPLIED WARRANTIES OF MERCHANTABILITY AND FITNESS FOR A PARTICULAR PURPOSE. To the extent permitted by applicable law, Cypress reserves the right to make changes to this document without further notice. Cypress does not assume any liability arising out of the application or use of any product or circuit described in this document. Any information provided in this document, including any sample design information or programming code, is provided only for reference purposes. It is the responsibility of the user of this document to properly design, program, and test the functionality and safety of any application made of this information and any resulting product. Cypress products are not designed, intended, or authorized for use as critical components in systems designed or intended for the operation of weapons, weapons systems, nuclear installations, life-support devices or systems, other medical devices or systems (including resuscitation equipment and surgical implants), pollution control or hazardous substances management, or other uses where the failure of the device or system could cause personal injury, death, or property damage ("Unintended Uses"). A critical component is any component of a device or system whose failure to perform can be reasonably expected to cause the failure of the device or system, or to affect its safety or effectiveness. Cypress is not liable, in whole or in part, and you shall and hereby do release Cypress from any claim, damage, or other liability arising from or related to all Unintended Uses of Cypress products. You shall indemnify and hold Cypress harmless from and against all claims, costs, damages, and other liabilities, including claims for personal injury or death, arising from or related to any Unintended Uses of Cypress products.

Cypress, the Cypress logo, Spansion, the Spansion logo, and combinations thereof, WICED, PSoC, CapSense, EZ-USB, F-RAM, and Traveo are trademarks or registered trademarks of Cypress in the United States and other countries. For a more complete list of Cypress trademarks, visit cypress.com. Other names and brands may be claimed as property of their respective owners.