

# QuPanel LTE HP MIMO 4x4

## Directional High Power multiband LTE MIMO 4x4 antenna

QuPanel LTE directional MIMO 4x4 high gain antenna is predicted for 4G LTE high categories from cat 5 up to cat 19. The antenna improves the signal in rural/suburban and locations where the mobile signal is weak. That antenna is predicted to be installed on the buildings (on the pole or on the wall). Due to very wide working frequency range, the antenna is universal client for LTE bands like LTE700/800/1800/1900/2100/2300/2600. It's compatible with all MIMO 4x4 LTE modems and routers working in categories: cat 5, cat 6, cat 7, cat 9, cat 10, cat 11, cat 12, cat 13, cat 15, cat 16, cat 18, cat 19.



### OUTDOOR

Use LTE router wherever you want

### ANTENNA

Maximize your signal with QuWireless antennas

### SOLUTION

Plug LTE router and you are good to go

## LTE SPECIFICATION

FREQUENCY	0.694-0.96 GHz 1.7 - 2.2 GHz 2.2 - 2.7 GHz
Supported LTE bands	1, 2, 3, 4, 5, 6, 7, 8, 9, 10, 12, 13, 14, 15, 16, 17, 18, 19, 20, 23, 25, 26, 27, 28, 29, 30, 33, 34, 35, 36, 37, 38, 39, 40, 41, 44, 53, 65, 66, 67, 68, 69, 70, 85
GAIN	0.694 - 0.96 GHz : 7 dBi 1.7 - 2.2 GHz : 7 dBi 2.2 - 2.7 GHz : 7 dBi
VSWR	<1.70, max <2.00
BEAMWIDTH	70°/70° ±15°
POLARIZATION	X-Pol
IMPEDANCE	50 Ω

## MECHANICAL SPECIFICATION

MATERIALS	ABS, aluminum, Fiberglass, galvanized steel
INGRESS PROTECTION	IP67
DIMENSIONS	392 x 392 x 96 mm 15.43 x 15.43 x 3.78 inch
WEIGHT	1.88 kg 4.15 lbs
OPERATING TEMPERATURE	From -40°C to 75°C From -40°F to 167°F

## VSWR

Port 1&3

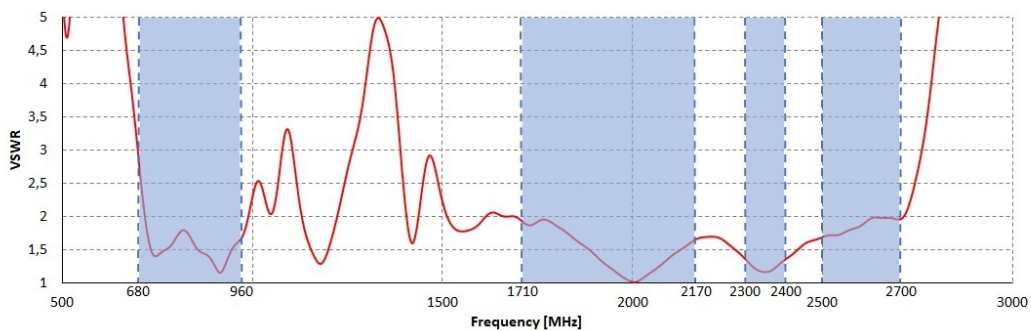

Port 2&4

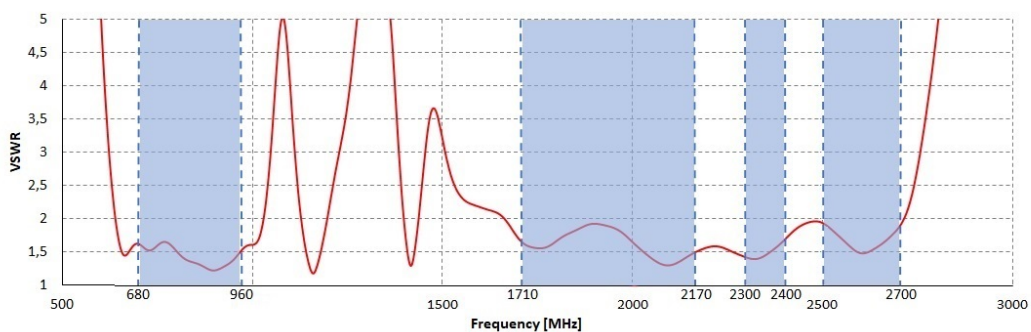

# PLOTS

Port 1&3, 700-900 MHz Azimuth

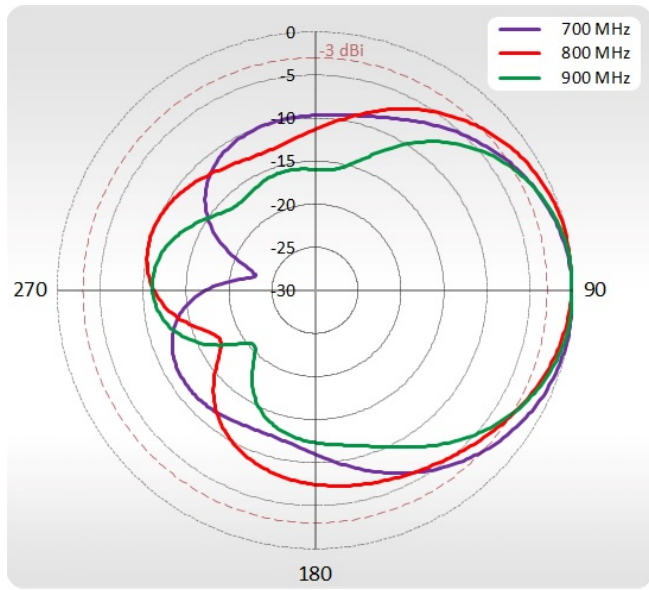

Port 1&3, 700-900 MHz Elevation

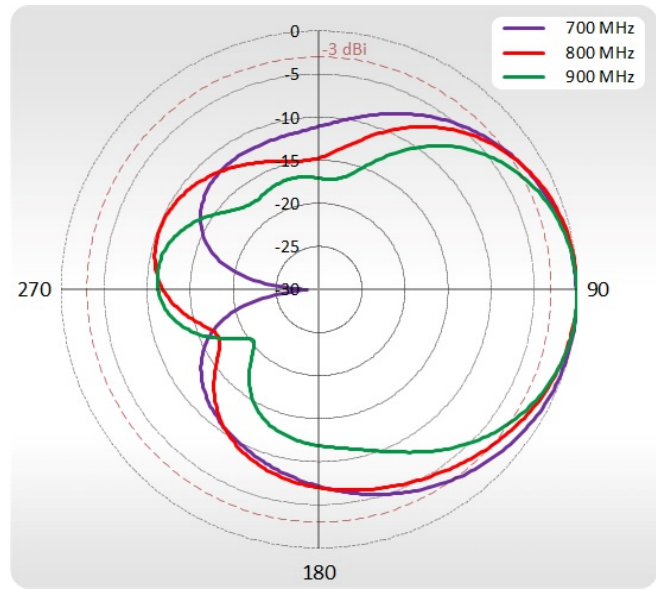

Port 1&3, 1710-2170 MHz Azimuth

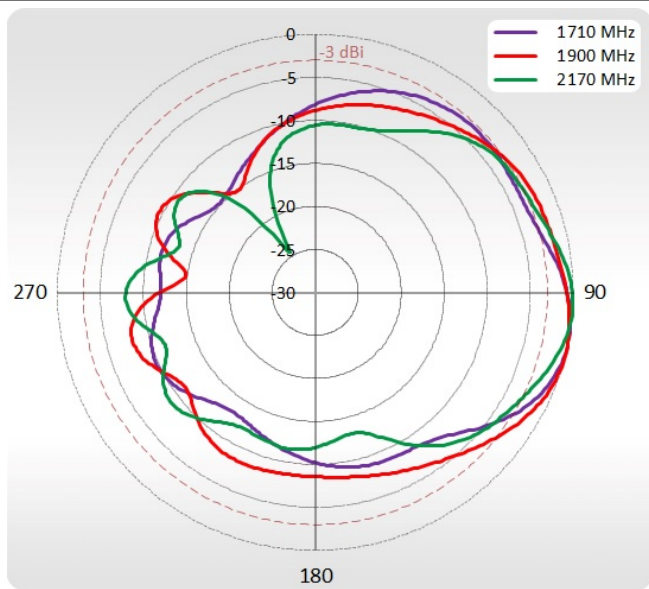

Port 1&3, 1710-2170 MHz Elevation

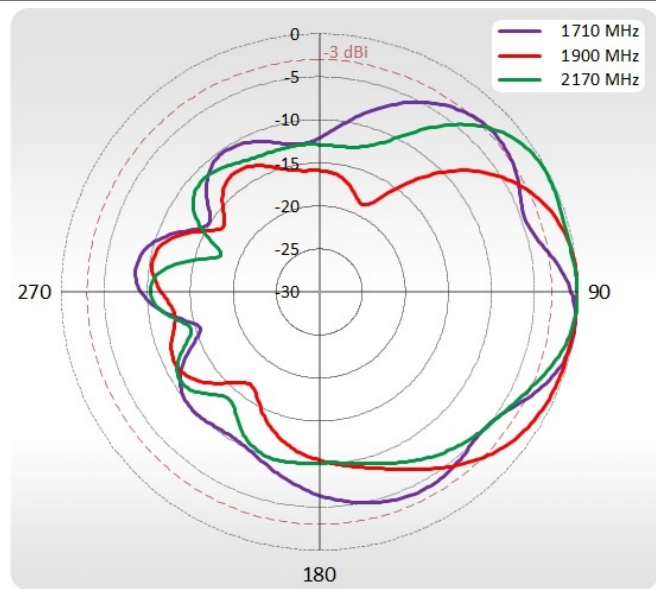

Port 1&3, 2300-2700 MHz Azimuth

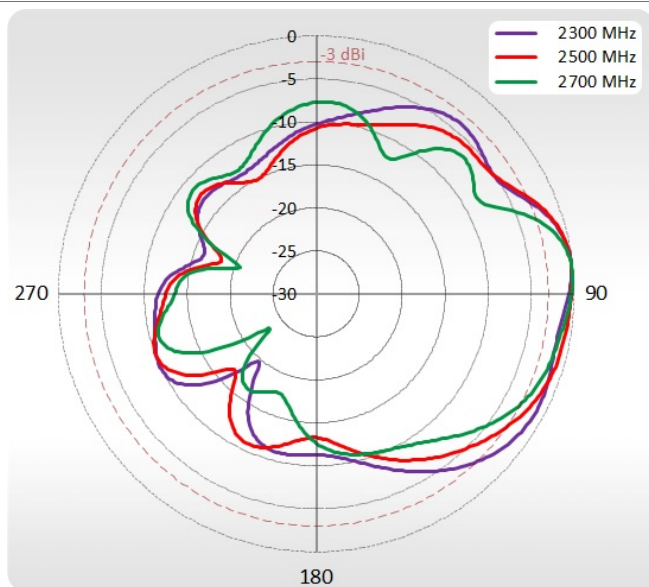

Port 1&3, 2300-2700 MHz Elevation

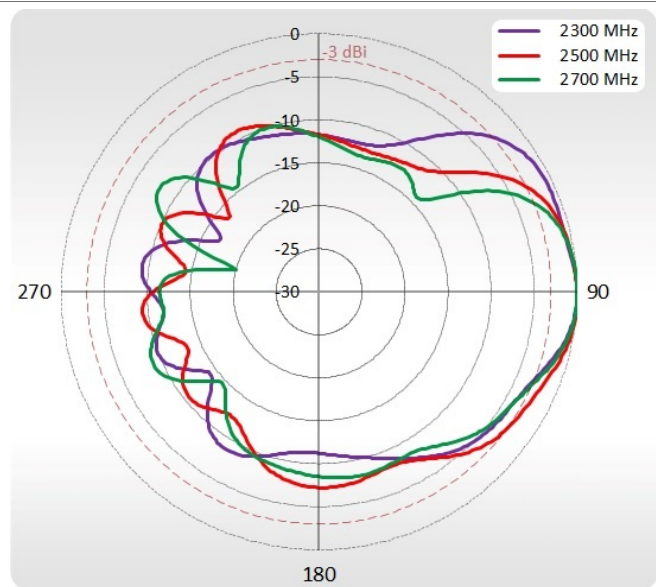



# PLOTS

Port 2&4, 700-900 MHz Azimuth

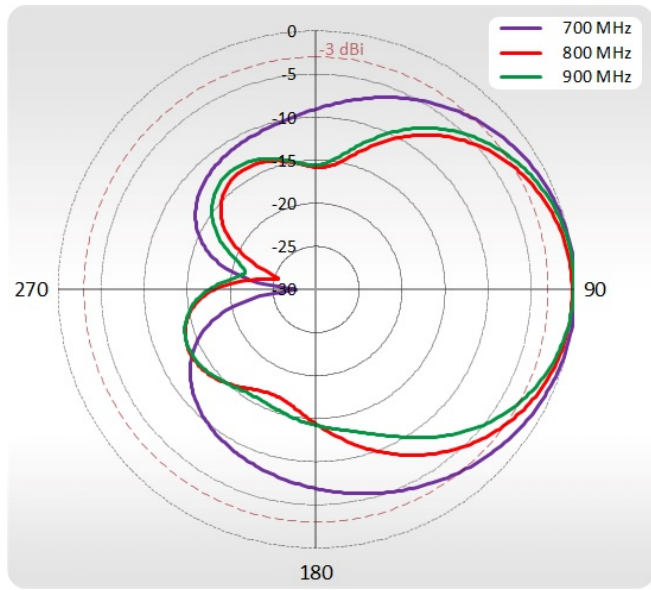

Port 2&4, 700-900 MHz Elevation

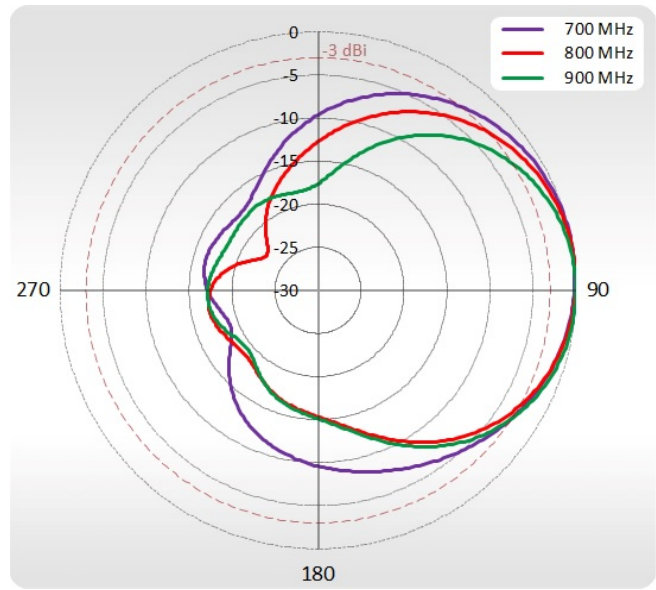

Port 2&4, 1710-2170 MHz Azimuth

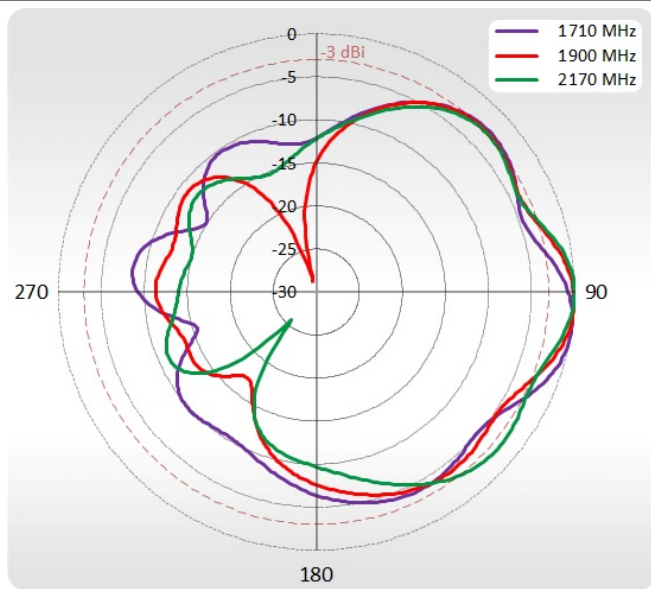

Port 2&4, 1710-2170 MHz Elevation

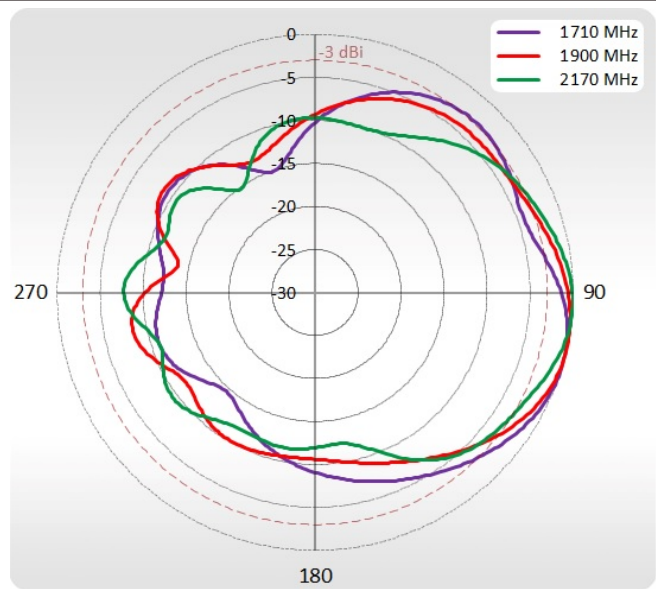

Port 2&4, 2300-2700 MHz Azimuth

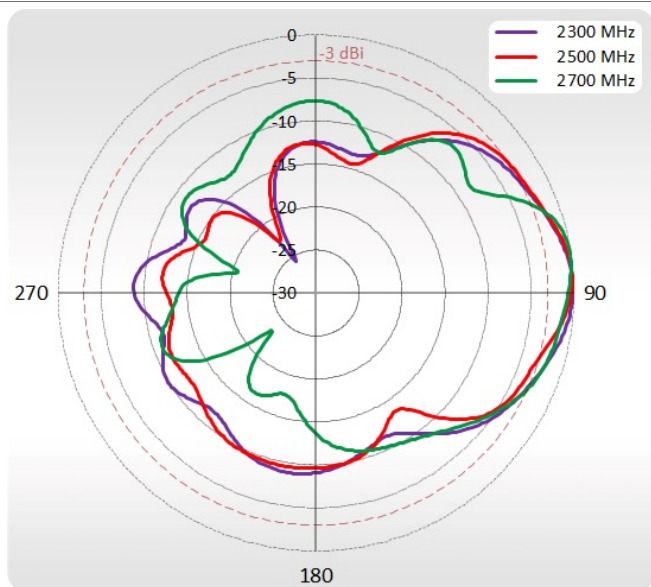

Port 2&4, 2300-2700 MHz Elevation

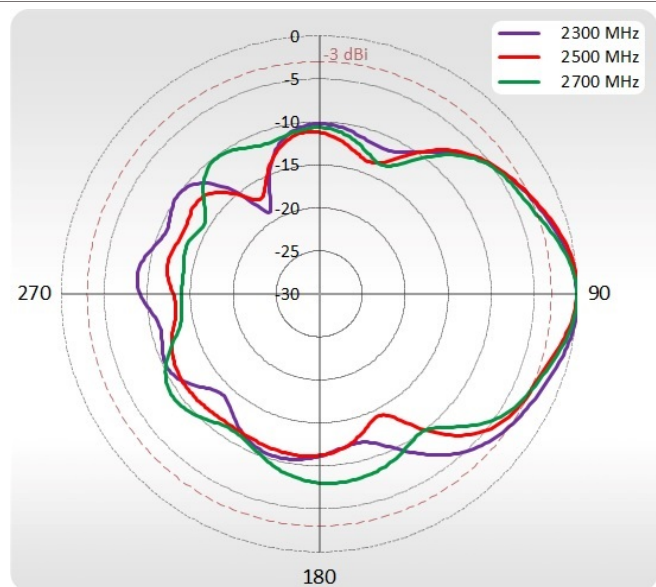

## PHOTOS



## DIMENSIONS

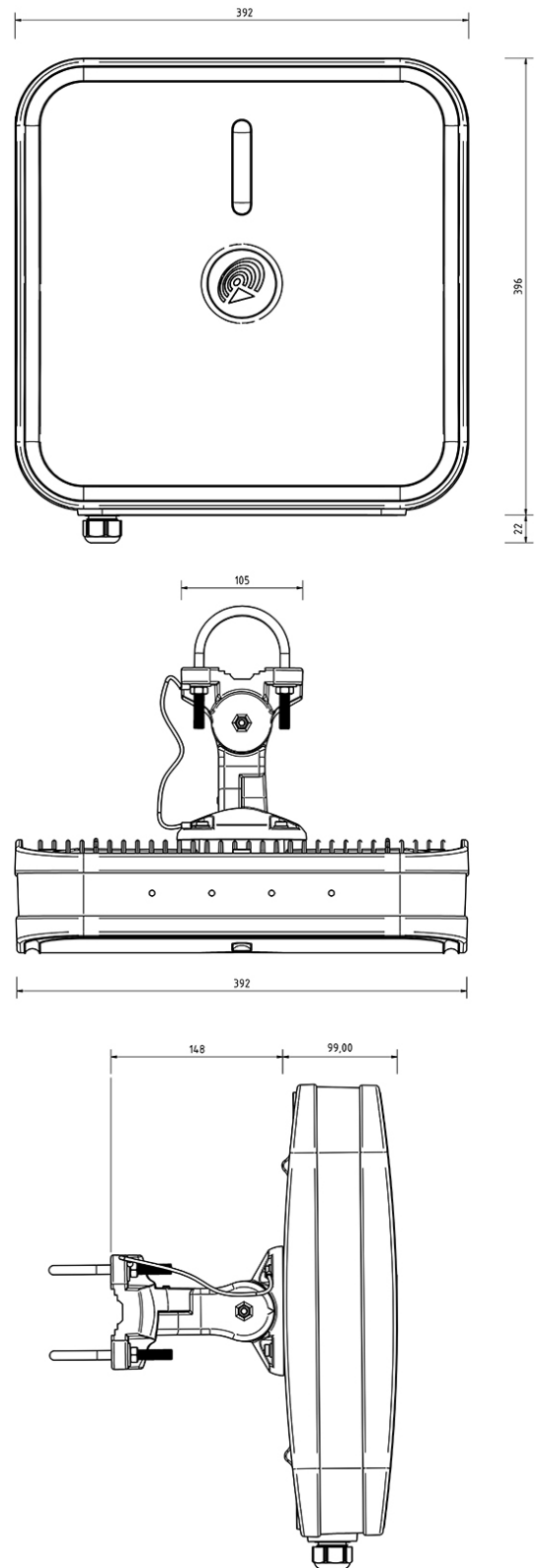

### HEADQUARTER:

Wireless Instruments sp. z o.o.

ul. Kościuszki 27

52-116 Iwiny

POLAND

[sales@quwireless.com](mailto:sales@quwireless.com)

tel 1. +48 601 366 369

tel 2. +48 577 667 761

[www.quwireless.com](http://www.quwireless.com)