

NOTES:

1. ROHS COMPLIANT
2. HEADER: DAP (DIALLYL PHTHALATE) WITH FLAMMABILITY RATING UL 94V-0 OR BETTER.
3. STORAGE TEMPERATURE: -20°C TO +125°C
4. COMPLIANCE TO J-STD:
  - A. J-STD-002: SOLDERABILITY AT 245°C REFLOW PROFILE
  - B. J-STD-020: LEVEL 1, NO MOISTURE SENSITIVE
  - C. J-STD-075: R7, 245°C MAXIMUM THROUGH REFLOW SOLDER
5. TO ORDER TAPE & REEL PACKAGING ADD A "T" SUFFIX TO THE PART NUMBER(i.e H7137FNL BECOMES H7137FNLT).

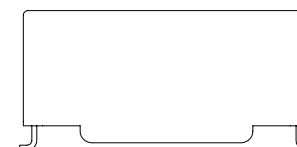
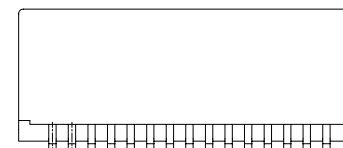
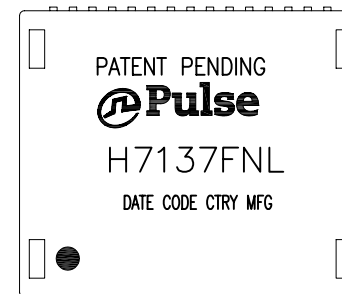

FINAL OUTLINE

© Copyright, 2014. Pulse Electronics Corp. All rights reserved. Pulse confidential & proprietary. (06/26/14)

PRODUCT DESCRIPTION	TLA DRAWING	PS DRAWING	SHEET	PART NO.	DATASHEET REV.
MDL,SIN,10GD,1:1,SM,CMS,180uH,2G,TU	H7137FNL-11	PS-2578.002-B	1 OF 3	H7137FNL	A

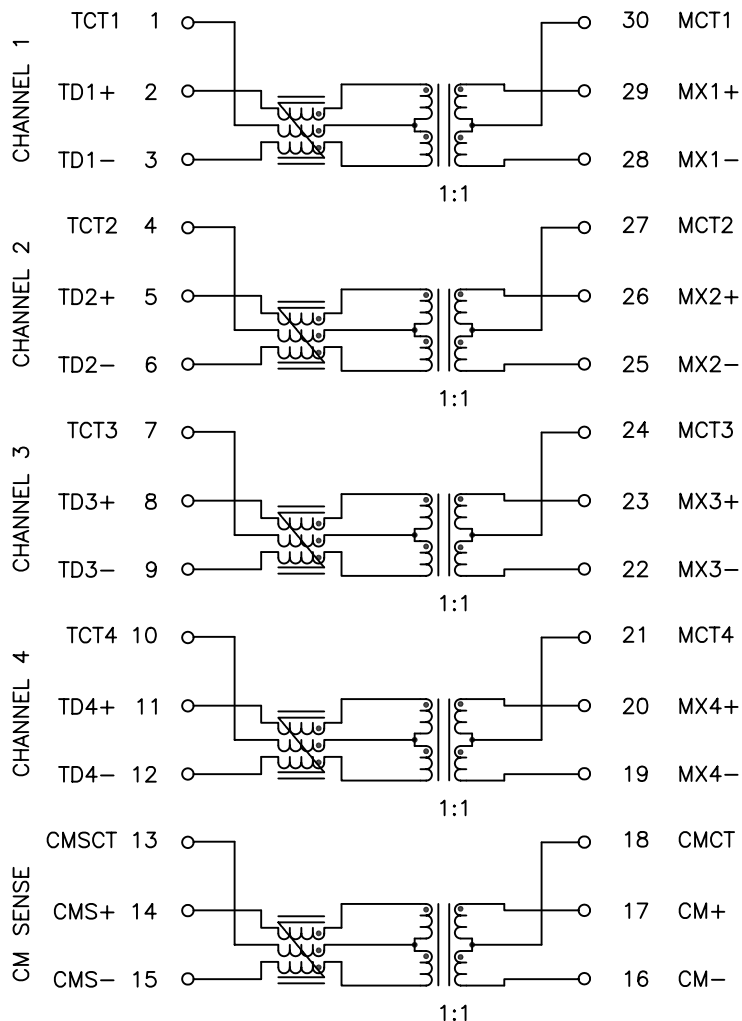

SCHEMATIC

ELECTRICAL CHARACTERISTICS AT +25°C UNLESS OTHER SPECIFIED  
MEETS IEEE 802.3 SPECIFICATION

PARAMETER	SPECIFICATIONS		
OPERATING TEMPERATURE	0°C TO 70°C		
TURNS RATIO	1.00 ± 2%		
POLARITY	PER SCHEMATIC		
INSERTION LOSS (SDD21)	100 KHz	1-400 MHz	
	-3.0 dB MAX	-1.0 dB MAX (-.6 dB TYP)	
PHY-SIDE RETURN LOSS (SDD11 - Zref = 100 OHMS ± 1%)	1 MHz	2 MHz-100 MHz	100 MHz-500 MHz
	-23 dB MIN	-25 dB MIN	-12+21.6*LOG <sub>10</sub> (f/400) dB MIN
LINE-SIDE RETURN LOSS (SDD22 - Zref = 100 OHMS ± 1%)	1 MHz - 40 MHz	40 MHz - 400 MHz	400 MHz - 500 MHz
	-23 dB MIN	-23+10*LOG <sub>10</sub> (f/40) dB MIN	-13+30*LOG <sub>10</sub> (f/400) dB MIN
INDUCTANCE (OCL)	180 uH MIN @ 100 kHz, 100 mV		
CROSSTALK, ADJACENT CHANNELS (SDD21 - ADJ.)	1-100 MHz	100-500 MHz	
	-40 dB MIN	-30 dB MIN	
COMMON MODE REJECTION RATIO (SCC21)	1 MHz-100 MHz	100-300 MHz	300-500 MHz
	-37 dB MIN	-30 dB MIN	-25 dB MIN
COMM. TO DIFF. REJECTION RATIO (SDC12)	1 MHz-100 MHz	100-300 MHz	300-500 MHz
	-40 dB MIN	-30 dB MIN	-25 dB MIN
CURRENT RATING	PINS 1-15	PINS 16,17,19,20,22,23,25,26,28,29	PINS 18,21,24,27,30
	300 mA MIN	600 mA MIN	1000 mA MIN
INPUT - OUTPUT ISOLATION	1500 VRMS MIN @ 60 SECONDS		

NOTE: f IS FREQUENCY IN MHZ.

© Copyright, 2014. Pulse Electronics Corp. All rights reserved. Pulse confidential & proprietary. (06/26/14)

PRODUCT DESCRIPTION	TLA DRAWING	PS DRAWING	SHEET	PART NO.	DATASHEET REV.
MDL,SIN,10GD,1:1,SM,CMS,180uH,2G,TU	H7137FNL-11	PS-2578.002-B	2 OF 3	H7137FNL	A

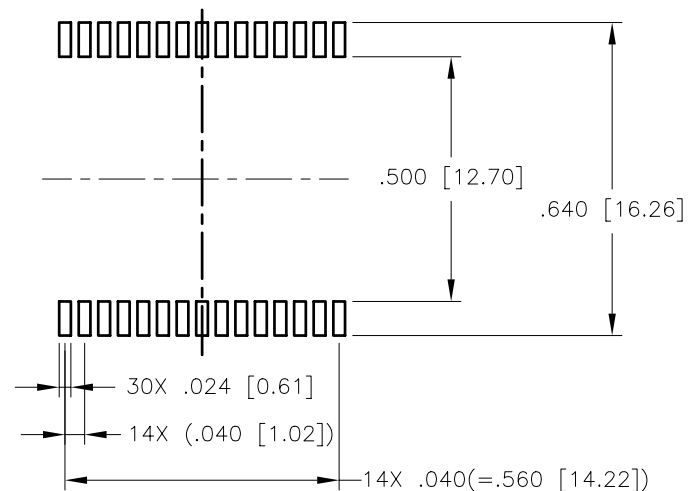
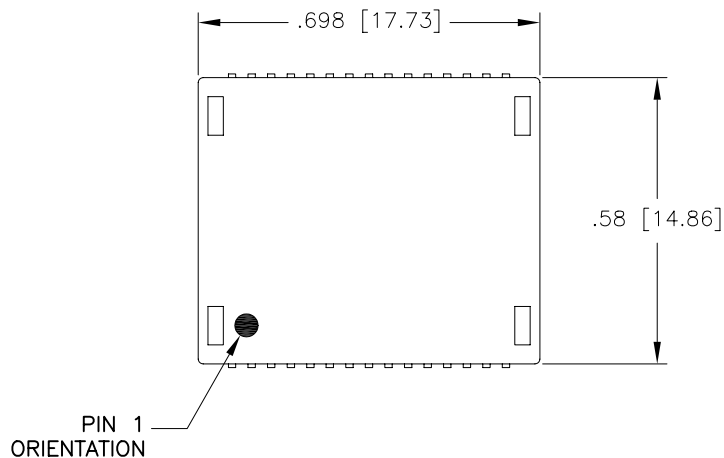

SUGGESTED LAND PATTERN

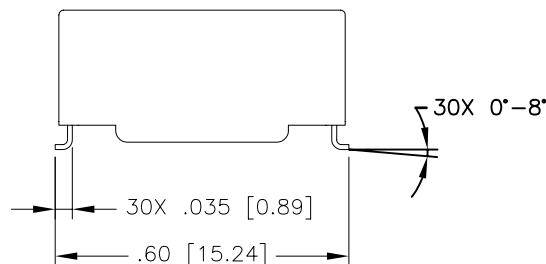
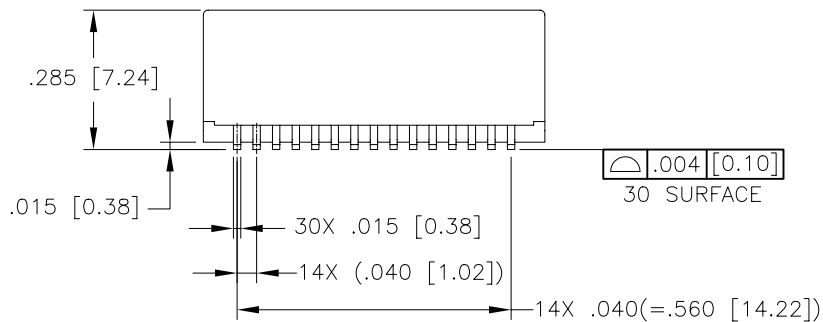

DIMENSIONS ARE IN INCHES [MILLIMETERS] WITH THE FOLLOWING TOLERANCES: [MILLIMETERS] ARE FOR REFERENCE ONLY.  
 .XX=  $\pm 0.01$  [ $\pm 0.25$ ]  
 .XXX=  $\pm 0.005$  [ $\pm 0.13$ ]

© Copyright, 2014. Pulse Electronics Corp. All rights reserved. Pulse confidential & proprietary. (06/26/14)

PRODUCT DESCRIPTION	TLA DRAWING	PS DRAWING	SHEET	PART NO.	DATASHEET REV.
MDL,SIN,10GD,1:1,SM,CMS,180uH,2G,TU	H7137FNL-11	PS-2578.002-B	3 OF 3	H7137FNL	A