



## GaAs MMIC FUNDAMENTAL MIXER, 2.5 - 7.0 GHz

### Typical Applications

The HMC557LC4 is ideal for:

- WiMAX & Fixed Wireless
- Point-to-Point Radios
- Point-to-Multi-Point Radios
- Test Equipment & Sensors
- Military End-Use

### Features

- Passive Double Balanced Topology
- Wide IF Bandwidth: DC - 3 GHz
- High LO/RF Isolation: 48 dB
- Low Conversion Loss: 7 dB
- 24 Lead Ceramic 4x4mm SMT Package: 16mm<sup>2</sup>

### Functional Diagram

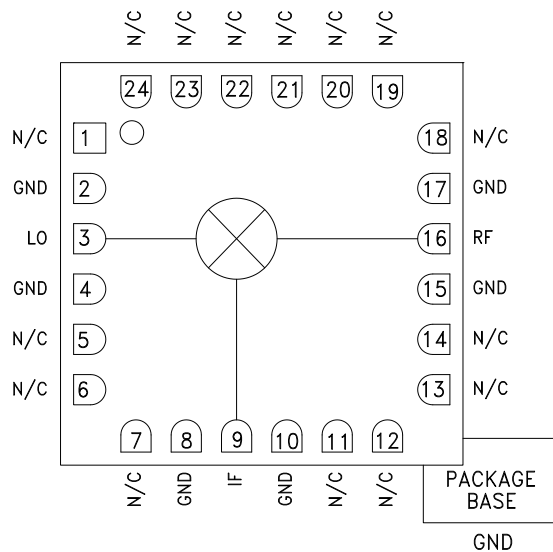

### General Description

The HMC557LC4 is a general purpose double balanced mixer in a leadless RoHS compliant SMT package that can be used as an upconverter or downconverter between 2.5 and 7 GHz. This mixer is fabricated in a GaAs MESFET process, and requires no external components or matching circuitry. The HMC557LC4 provides excellent LO to RF and LO to IF isolation due to optimized balun structures and operates with LO drive levels as low as +9 dBm. The RoHS compliant HMC557LC4 eliminates the need for wire bonding, and is compatible with high volume surface mount manufacturing techniques.

### Electrical Specifications, $T_A = +25^\circ\text{C}$ , $IF = 100\text{ MHz}$ , $LO = +15\text{ dBm}^*$

Parameter	Min.	Typ.	Max.	Min.	Typ.	Max.	Units
Frequency Range, RF & LO	2.5 - 5.0		5.0 - 7.0				GHz
Frequency Range, IF	DC - 3		DC - 3				GHz
Conversion Loss		7	9.5		8.5	10.5	dB
Noise Figure (SSB)		7	9.5		8.5	10.5	dB
LO to RF Isolation	40	48		40	48		dB
LO to IF Isolation	26	32		25	30		dB
RF to IF Isolation	12	18		20	25		dB
IP3 (Input)		17			22		dBm
IP2 (Input)		50			50		dBm
1 dB Gain Compression (Input)		10			13		dBm

\*Unless otherwise noted, all measurements performed as downconverter,  $IF = 100\text{ MHz}$ .



**GaAs MMIC FUNDAMENTAL MIXER, 2.5 - 7.0 GHz**

**Conversion Gain vs. Temperature @ LO = +15 dBm**

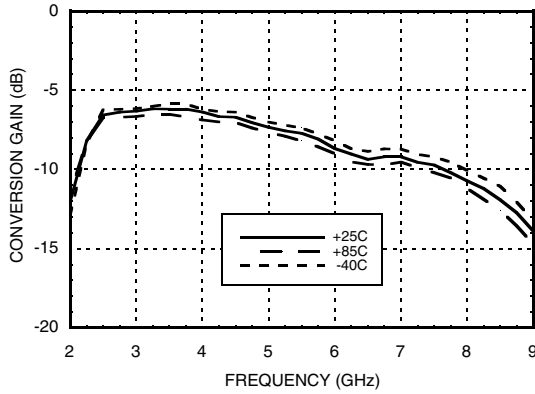

**Isolation @ LO = +15 dBm**

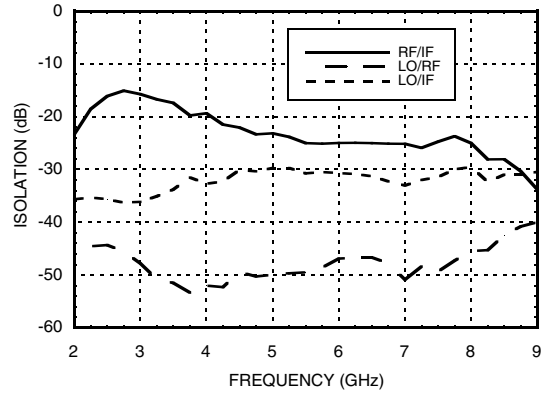

**Conversion Gain vs. LO Drive**

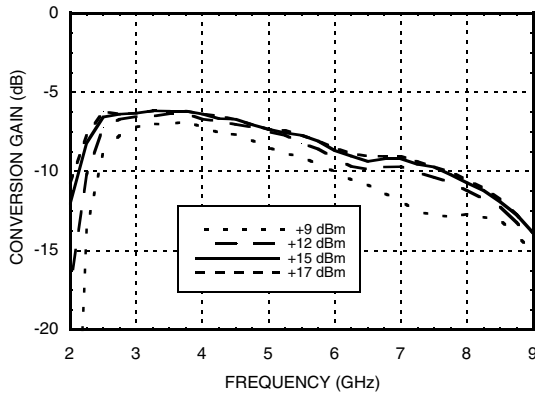

**Return Loss @ LO = +15 dBm**

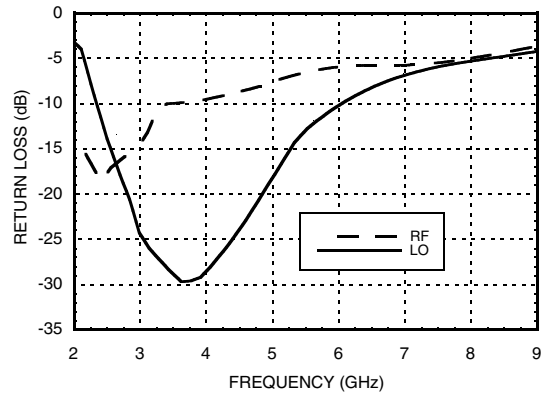

**IF Bandwidth @ LO = +15 dBm**

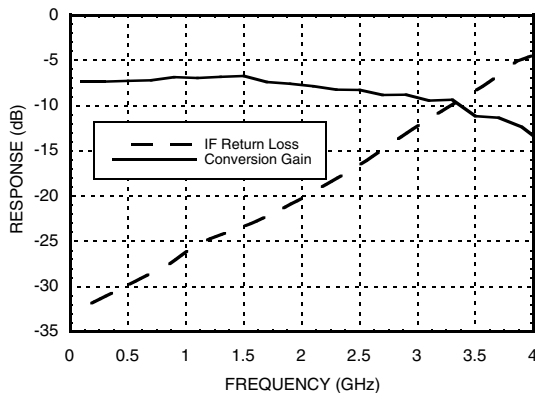

**Upconverter Performance Conversion Gain vs. LO Drive**

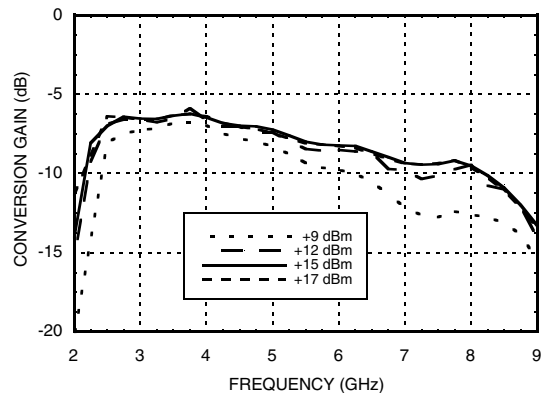

Information furnished by Analog Devices is believed to be accurate and reliable. However, no responsibility is assumed by Analog Devices for its use, nor for any infringements of patents or other rights of third parties that may result from its use. Specifications subject to change without notice. No license is granted by implication or otherwise under any patent or patent rights of Analog Devices. Trademarks and registered trademarks are the property of their respective owners.

For price, delivery, and to place orders: Analog Devices, Inc., One Technology Way, P.O. Box 9106, Norwood, MA 02062-9106 Phone: 781-329-4700 • Order online at [www.analog.com](http://www.analog.com) Application Support: Phone: 1-800-ANALOG-D



**GaAs MMIC FUNDAMENTAL MIXER, 2.5 - 7.0 GHz**

**Input IP3 vs. LO Drive \***

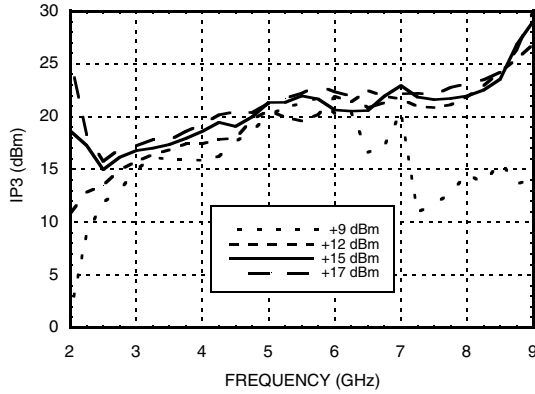

**Input IP3 vs. Temperature @ LO = +15 dBm \***

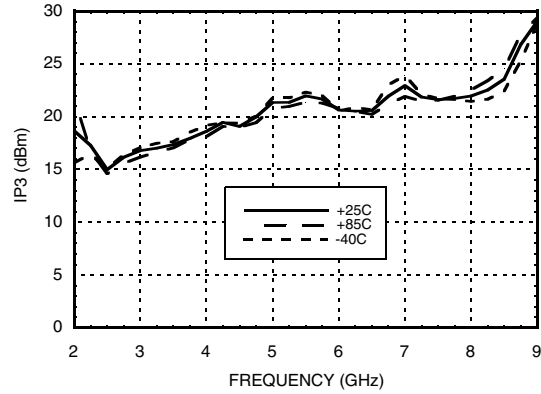

**Input IP2 vs. LO Drive \***

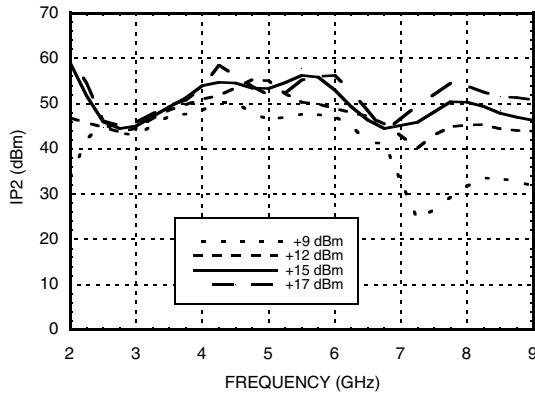

**Input IP2 vs. Temperature @ LO = +15 dBm \***

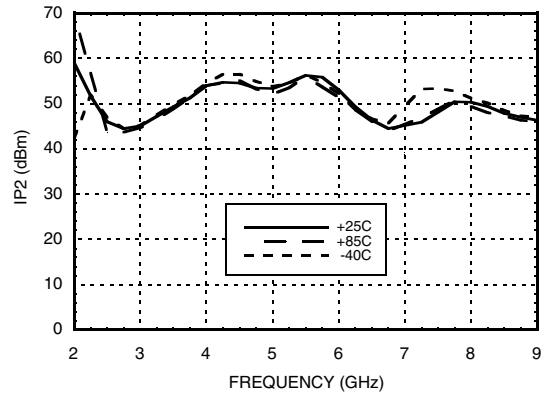

**Input P1dB vs. Temperature @ LO = +15 dBm**

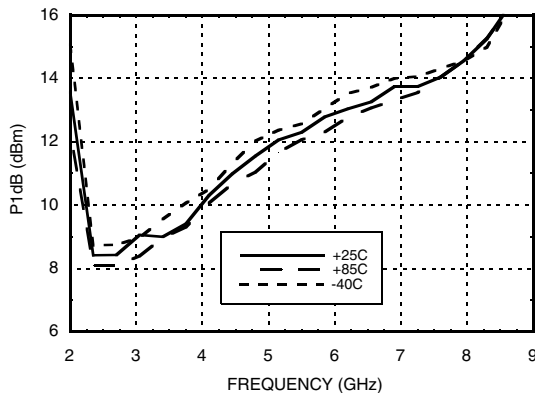

**MxN Spurious Outputs**

		nLO				
mRF		0	1	2	3	4
0	xx	-1	28	25	52	
1	17	0	37	40	69	
2	77	57	69	56	77	
3	77	77	77	74	77	
4	77	77	77	77	77	

RF = 5.1 GHz @ -10 dBm  
 LO = 5 GHz @ +15 dBm  
 All values in dBc below the IF output power level.

\* Two-tone input power = -10 dBm each tone, 1 MHz spacing.

Information furnished by Analog Devices is believed to be accurate and reliable. However, no responsibility is assumed by Analog Devices for its use, nor for any infringements of patents or other rights of third parties that may result from its use. Specifications subject to change without notice. No license is granted by implication or otherwise under any patent or patent rights of Analog Devices. Trademarks and registered trademarks are the property of their respective owners.

For price, delivery, and to place orders: Analog Devices, Inc., One Technology Way, P.O. Box 9106, Norwood, MA 02062-9106 Phone: 781-329-4700 • Order online at [www.analog.com](http://www.analog.com) Application Support: Phone: 1-800-ANALOG-D



## GaAs MMIC FUNDAMENTAL MIXER, 2.5 - 7.0 GHz

### Absolute Maximum Ratings

RF / IF Input	+25 dBm
LO Drive	+25 dBm
Channel Temperature	150 °C
Continuous P <sub>diss</sub> (T = 85 °C) (derate 5.2 mW/°C above 85 °C)	339 mW
Thermal Resistance (channel to ground paddle)	192 °C/W
Storage Temperature	-65 to +150 °C
Operating Temperature	-40 to +85 °C



ELECTROSTATIC SENSITIVE DEVICE  
OBSERVE HANDLING PRECAUTIONS

### Outline Drawing

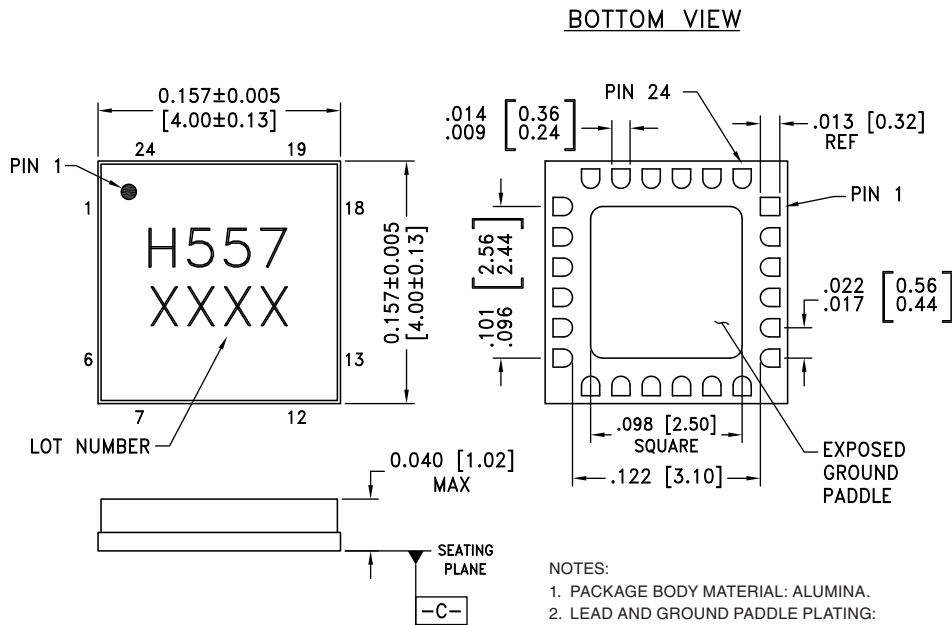

NOTES:

1. PACKAGE BODY MATERIAL: ALUMINA.
2. LEAD AND GROUND PADDLE PLATING:  
30-80 MICROINCHES GOLD OVER 50 MICROINCHES MINIMUM NICKEL.
3. DIMENSIONS ARE IN INCHES (MILLIMETERS).
4. LEAD SPACING TOLERANCE IS NON-CUMULATIVE.
5. CHARACTERS TO BE HELVETICA MEDIUM, .025 HIGH, BLACK INK, OR LASER MARK LOCATED APPROX. AS SHOWN.
6. PACKAGE WARP SHALL NOT EXCEED 0.05MM DATUM - C -
7. ALL GROUND LEADS AND GROUND PADDLE MUST BE SOLDERED TO PCB RF GROUND.

### Package Information

Part Number	Package Body Material	Lead Finish	MSL Rating	Package Marking <sup>[2]</sup>
HMC557LC4	Alumina, White	Gold over Nickel	MSL3 <sup>[1]</sup>	H557 XXXX

[1] Max peak reflow temperature of 260 °C

[2] 4-Digit lot number XXXX



## GaAs MMIC FUNDAMENTAL MIXER, 2.5 - 7.0 GHz

### Pin Descriptions

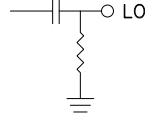
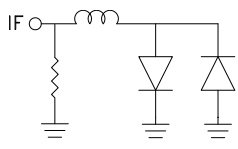
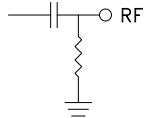
Pin Number	Function	Description	Interface Schematic
1, 5 - 7, 11 - 14, 18 - 24	N/C	No connection required. These pins may be connected to RF/DC ground without affecting performance.	
2, 4, 8, 10, 15, 17	GND	Package bottom must also be connected to RF/DC ground.	
3	LO	This pin is DC coupled and matched to 50 Ohms.	
9	IF	This pin is DC coupled. For applications not requiring operation to DC, this port should be DC blocked externally using a series capacitor whose value has been chosen to pass the necessary IF frequency range. For operation to DC, this pin must not source or sink more than 2 mA of current or part non-function and possible part failure will result.	
16	RF	This pin is DC coupled and matched to 50 Ohms.	



### Evaluation PCB

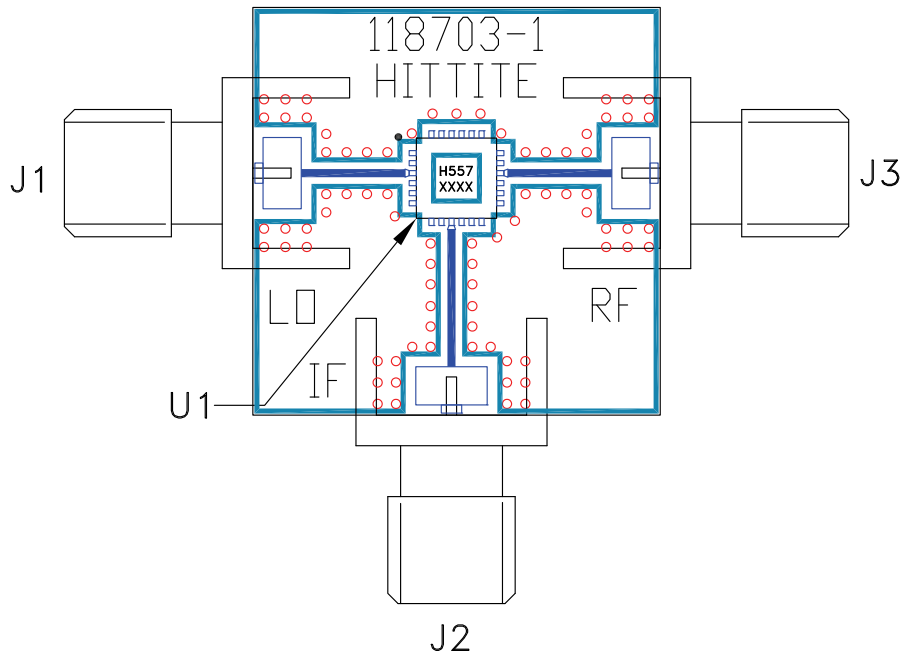

### List of Materials for Evaluation PCB 118704 [1]

Item	Description
J1 - J2	SRI SMA Connector
J3	Johnson SMA Connector
U1	HMC557LC4 Mixer
PCB [2]	118703 Evaluation PCB

[1] Reference this number when ordering complete evaluation PCB

[2] Circuit Board Material: Rogers 4350

The circuit board used in this application should use RF circuit design techniques. Signal lines should have 50 Ohm impedance while the package ground leads and exposed paddle should be connected directly to the ground plane similar to that shown. A sufficient number of via holes should be used to connect the top and bottom ground planes. The evaluation circuit board shown is available from Hittite upon request.