



THIS SPEC IS OBSOLETE

Spec No: 38-05201

Spec Title: CY62137CV30/33 MOBL(R) AND CY62137CV
MOBL(R) 2-MBIT (128K X 16) STATIC RAM

Sunset Owner: Nikhil Mittal (NIKM)

Replaced by: None

Features

- Very high speed: 55 ns
- Temperature ranges
 - Industrial: -40°C to +85°C
 - Automotive-E: -40°C to +125°C
- Pin compatible with CY62137V
- Ultra low active power
 - Typical active current: 1.5 mA at f = 1 MHz
 - Typical active current: 7 mA at f = f_{MAX} (55 ns speed)
- Low and ultra low standby power
- Easy memory expansion with \overline{CE} and \overline{OE} features
- Automatic power down when deselected
- CMOS for optimum speed and power
- Available in Pb-free and non Pb-free 48-ball FBGA package

Functional Description

The CY62137CV30/33 and CY62137CV are high-performance CMOS static RAMs organized as 128K words by 16 bits. These devices feature advanced circuit design to provide ultra low active current. This is ideal for providing More Battery Life (MoBL) in portable applications such as cellular telephones. These devices also have an automatic power down feature that significantly reduces power consumption by 80 percent when

addresses are not toggling. Placing the device into standby mode reduces power consumption by more than 99 percent when deselected; Chip Enable (\overline{CE}) HIGH or both Byte Low Enable (BLE) and Byte High Enable (BHE) are HIGH. The input and output pins (IO₀ through IO₁₅) are placed in a high-impedance state in the following conditions:

- Deselected (\overline{CE} HIGH)
- Outputs are disabled (\overline{OE} HIGH)
- Both BHE and BLE are disabled (\overline{BHE} , \overline{BLE} HIGH)
- Write operation is active (\overline{CE} LOW and Write Enable (\overline{WE}) LOW)

Write to the device by taking \overline{CE} and \overline{WE} inputs LOW. If \overline{BLE} is LOW, then data from the IO pins (IO₀ through IO₇) is written into the location specified on the address pins (A₀ through A₁₆). If BHE is LOW, then data from the IO pins (IO₈ through IO₁₅) is written into the location specified on the address pins (A₀ through A₁₆).

Read from the device by taking Chip Enable (\overline{CE}) and Output Enable (\overline{OE}) LOW, while forcing the Write Enable (\overline{WE}) HIGH. If BLE is LOW, then data from the memory location specified by the address pins appear on IO₀ to IO₇. If BHE is LOW, then data from memory appears on IO₈ to IO₁₅. See the "Truth Table" on page 11 for a complete description of read and write modes.

For best practice recommendations, refer to the Cypress application note AN1064, SRAM System Guidelines.

Logic Block Diagram

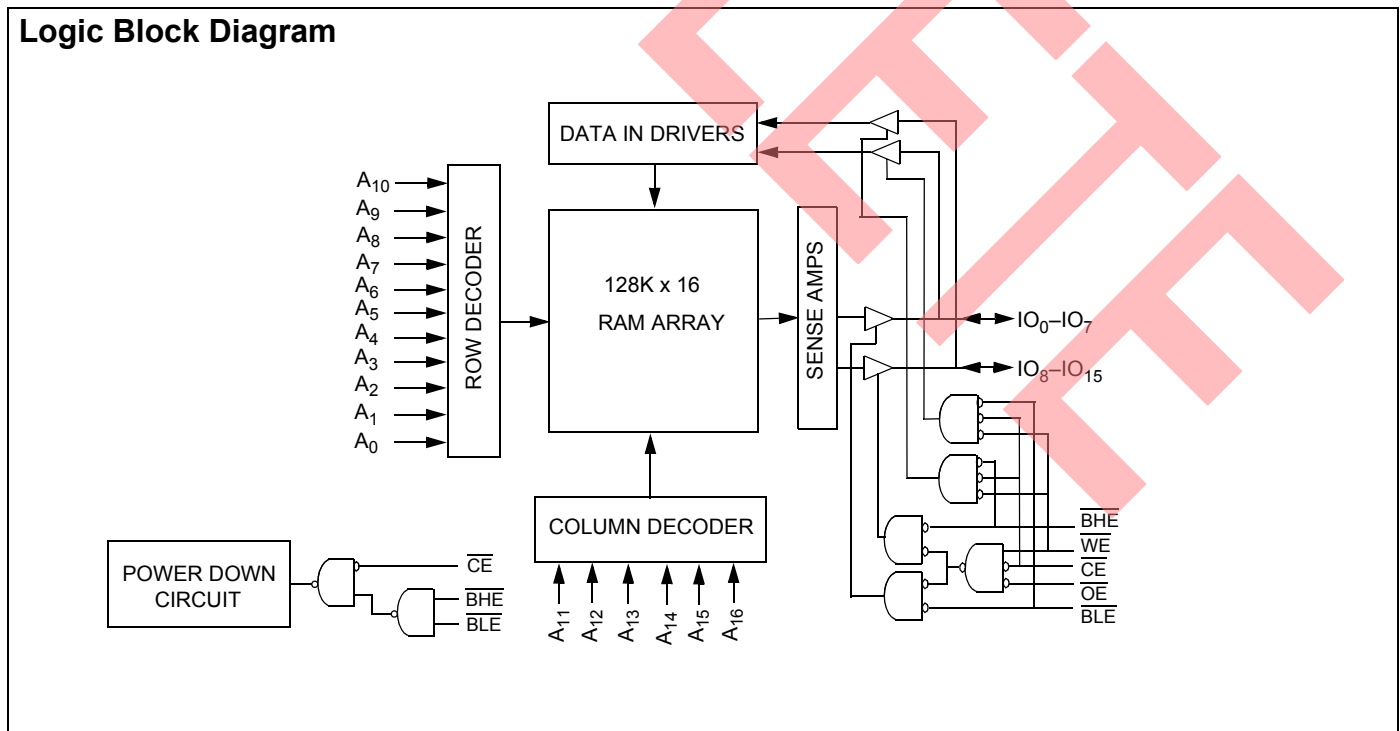

Product Portfolio

Product	Range	V _{CC} Range (V)			Speed (ns)	Power Dissipation					
						Operating I _{CC} (mA)				Standby I _{SB2} (μA)	
		f = 1 MHz		f = f _{MAX}							
		Min	Typ ^[1]	Max		Typ ^[1]	Max	Typ ^[1]	Max	Typ ^[1]	Max
CY62137CV30LL	Industrial	2.7	3.0	3.3	55	1.5	3	7	15	2	10
					70	1.5	3	5.5	12		
CY62137CV30LL	Automotive	2.7	3.0	3.3	70	1.5	3	5.5	15	2	15
CY62137CV33LL	Industrial	3.0	3.3	3.6	55	1.5	3	7	15	5	15
CY62137CVSL	Industrial	2.9	3.3	3.6	70	1.5	3	5.5	12	1	5

Pin Configuration

Figure 1. 48-Ball FBGA Pinout [2, 3]

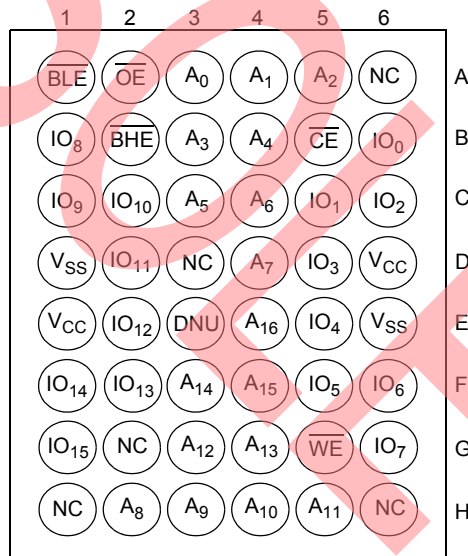

Notes

1. Typical values are included for reference only and are not guaranteed or tested. Typical values are measured at V_{CC} = V_{CC(TYP)}, T_A = 25°C.
2. NC pins are not connected on the die.
3. To ensure proper operation, leave floating E3 (DNU) pin or tie to V_{SS}.

Maximum Ratings

Exceeding maximum ratings may shorten the useful life of the device. User guidelines are not tested.

Storage Temperature	-65°C to + 150°C
Ambient Temperature with Power Applied	-55°C to + 125°C
Supply Voltage to Ground Potential.....	- 0.5V to $V_{CC(Max)}$ + 0.5V
DC Voltage Applied to Outputs in High-Z State ^[4]	-0.5V to V_{CC} + 0.3V
DC Input Voltage ^[4]	-0.5V to V_{CC} + 0.3V

Output Current into Outputs (LOW)	20 mA
Static Discharge Voltage	> 2001V (MIL-STD-883, Method 3015)
Latch up Current	> 200 m

Operating Range

Device	Range	Ambient Temperature	V_{CC}
CY62137CV30	Industrial	-40°C to +85°C	2.7V to 3.3V
CY62137CV33			3.0V to 3.6V
CY62137CV			2.9V to 3.6V
CY62137CV30	Automotive	-40°C to +125°C	2.7V to 3.3V

Electrical Characteristics

Over the operating range

Parameter	Description	Test Conditions	CY62137CV30-55			CY62137CV30-70			Unit
			Min	Typ ^[1]	Max	Min	Typ ^[1]	Max	
V_{OH}	Output HIGH Voltage	$I_{OH} = -1.0$ mA	2.4			2.4			V
V_{OL}	Output LOW Voltage	$I_{OL} = 2.1$ mA			0.4			0.4	V
V_{IH}	Input HIGH Voltage		2.2		$V_{CC} + 0.3$	2.2		$V_{CC} + 0.3$	V
V_{IL}	Input LOW Voltage		-0.3		0.8	-0.3		0.8	V
I_{IX}	Input Leakage Current	$GND \leq V_I \leq V_{CC}$	Ind'l	-1	+1	-1		+1	μ A
			Auto			-2		+2	
I_{OZ}	Output Leakage Current	$GND \leq V_O \leq V_{CC}$, output disabled	Ind'l	-1	+1	-1		+1	μ A
			Auto			-2		+2	
I_{CC}	V_{CC} Operating Supply Current	$f = f_{MAX} = 1/t_{RC}$	$V_{CC} = V_{CC(Max)}$ $I_{OUT} = 0$ mA CMOS levels	Ind'l	7	15	5.5	12	mA
				Auto			5.5	15	
		$f = 1$ MHz	Ind'l	1.5	3	1.5	3		
			Auto			1.5	3		
I_{SB1}	Automatic CE Power Down Current – CMOS Inputs	$\overline{CE} \geq V_{CC} - 0.2V$, $V_{IN} \geq V_{CC} - 0.2V$ or $V_{IN} \leq 0.2V$ $f = f_{MAX}$ (address and data only), $f = 0$ (\overline{OE} , \overline{WE} , \overline{BHE} , and \overline{BLE}),	Ind'l	2	10	2	10	μ A	
			Auto			2	15		
I_{SB2}	Automatic CE Power Down Current – CMOS Inputs	$\overline{CE} \geq V_{CC} - 0.2V$, $V_{IN} \geq V_{CC} - 0.2V$ or $V_{IN} \leq 0.2V$, $f = 0$, $V_{CC} = 3.3V$	Ind'l	2	10	2	10	μ A	
			Auto			2	15		

Note

4. $V_{IL(Min)}$ = -2.0V for pulse durations less than 20 ns.

Electrical Characteristics (Continued)

Over the operating range

Parameter	Description	Test Conditions	CY62137CV33-55			CY62137CV-70			Unit
			Min	Typ ^[1]	Max	Min	Typ ^[1]	Max	
V _{OH}	Output HIGH Voltage	I _{OH} = -1.0 mA V _{CC} = 3.0V V _{CC} = 2.9V	2.4			2.4			V
						2.4			V
V _{OL}	Output LOW Voltage	I _{OL} = 2.1 mA V _{CC} = 3.0V V _{CC} = 2.9V			0.4			0.4	V
								0.4	V
V _{IH}	Input HIGH Voltage		2.2		V _{CC} + 0.3	2.2		V _{CC} + 0.3	V
V _{IL}	Input LOW Voltage		-0.3		0.8	-0.3		0.8	V
I _{IX}	Input Leakage Current	GND ≤ V _I ≤ V _{CC}	-1		+1	-1		+1	μA
I _{OZ}	Output Leakage Current	GND ≤ V _O ≤ V _{CC} ; output disabled	-1		+1	-1		+1	μA
I _{CC}	V _{CC} Operating Supply Current	f = f _{MAX} = 1/t _{RC} f = 1 MHz V _{CC} = V _{CC(Max)} I _{OUT} = 0 mA CMOS levels		7	15		5.5	12	mA
				1.5	3		1.5	3	
I _{SB1}	Automatic CE Power Down Current – CMOS Inputs	CE ≥ V _{CC} - 0.2V, V _{IN} ≥ V _{CC} - 0.2V or V _{IN} ≤ 0.2V f = f _{MAX} (address and data only), f = 0 (\overline{OE} , \overline{WE} , \overline{BHE} , and \overline{BLE}),		5	15		5	15	μA
I _{SB2}	Automatic CE Power Down Current – CMOS Inputs	CE ≥ V _{CC} - 0.2V, V _{IN} ≥ V _{CC} - 0.2V or V _{IN} ≤ 0.2V, f = 0, V _{CC} = 3.6V	LL	5	15				μA
			SL				1	5	

Capacitance

Tested initially and after any design or process changes that may affect these parameters

Parameter	Description	Test Conditions	Max	Unit
C _{IN}	Input Capacitance	T _A = 25°C, f = 1 MHz,	6	pF
C _{OUT}	Output Capacitance	V _{CC} = V _{CC(Typ)}	8	pF

Thermal Resistance

Tested initially and after any design or process changes that may affect these parameters

Parameter	Description	Test Conditions	FBGA	Unit
θ _{JA}	Thermal Resistance (junction to ambient)	Still air, soldered on a 3 × 4.5 inch, two layer printed circuit board	55	°C/W
θ _{JC}	Thermal Resistance (junction to case)		16	°C/W

AC Test Loads and Waveforms

Figure 2. AC Test Loads and Waveform

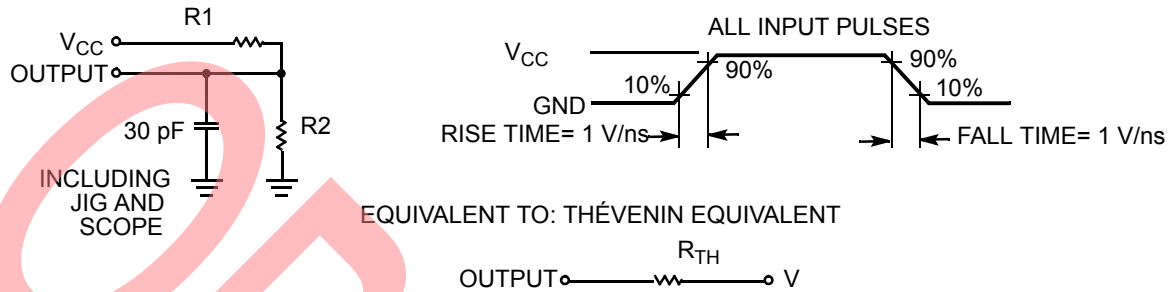

Parameters	3.0V	3.3V	Unit
R1	1105	1216	Ω
R2	1550	1374	Ω
R _{TH}	645	645	Ω
V _{TH}	1.75	1.75	V

Data Retention Characteristics

Over the operating range

Parameter	Description	Conditions	Min	Typ ^[1]	Max	Unit
V _{DR}	V _{CC} for Data Retention		1.5			V
I _{CCDR}	Data Retention Current	V _{CC} = 1.5V, CE ≥ V _{CC} - 0.2V, V _{IN} ≥ V _{CC} - 0.2V or V _{IN} ≤ 0.2V		1	6	μA
		LL			8	
		SL			4	
t _{CDR} ^[5]	Chip Deselect to Data Retention Time		0			ns
t _R ^[6]	Operation Recovery Time		t _{RC}			ns

Data Retention Waveform

Figure 3. Data Retention Waveform^[7]

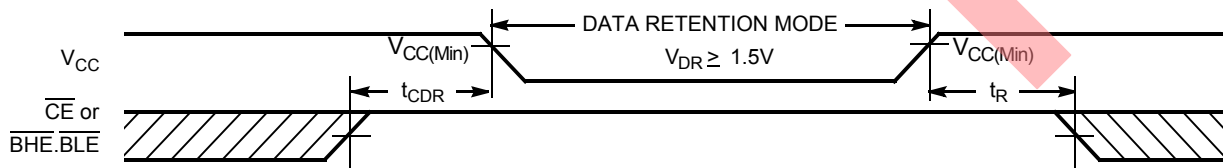

Notes

5. Tested initially and after any design or process changes that may affect these parameters.
6. Full device operation requires linear V_{CC} ramp from V_{DR} to V_{CC(Min)} > 100 μs or stable at V_{CC(Min)} > 100 μs.
7. BHE..BLE is the AND of BHE and BLE. Deselect the chip by either disabling chip enable signals or by disabling BHE and BLE.

Switching Characteristics

Over the operating range ^[8]

Parameter	Description	55 ns		70 ns		Unit
		Min	Max	Min	Max	
Read Cycle						
t _{RC}	Read Cycle Time	55		70		ns
t _{AA}	Address to Data Valid		55		70	ns
t _{OHA}	Data Hold From Address Change	10		10		ns
t _{ACE}	\overline{CE} LOW to Data Valid		55		70	ns
t _{DOE}	\overline{OE} LOW to Data Valid		25		35	ns
t _{LZOE}	\overline{OE} LOW to Low-Z ^[9]	5		5		ns
t _{HZOE}	\overline{OE} HIGH to High-Z ^[9, 10]		20		25	ns
t _{LZCE}	\overline{CE} LOW to Low-Z ^[9]	10		10		ns
t _{HZCE}	\overline{CE} HIGH to High-Z ^[9, 10]		20		25	ns
t _{PU}	\overline{CE} LOW to Power Up	0		0		ns
t _{PD}	\overline{CE} HIGH to Power Down		55		70	ns
t _{DBE}	$\overline{BLE/BHE}$ LOW to Data Valid		55		70	ns
t _{LZBE}	$\overline{BLE/BHE}$ LOW to Low-Z ^[9, 11]	5		5		ns
t _{HZBE}	$\overline{BLE/BHE}$ HIGH to High-Z ^[9, 10]		20		25	ns
Write Cycle ^[12]						
t _{WC}	Write Cycle Time	55		70		ns
t _{SCE}	\overline{CE} LOW to Write End	45		60		ns
t _{AW}	Address Setup to Write End	45		60		ns
t _{HA}	Address Hold from Write End	0		0		ns
t _{SA}	Address Setup to Write Start	0		0		ns
t _{PWE}	\overline{WE} Pulse Width	40		45		ns
t _{BW}	$\overline{BLE/BHE}$ LOW to Write End	50		60		ns
t _{SD}	Data Setup to Write End	25		30		ns
t _{HD}	Data Hold From Write End	0		0		ns
t _{HZWE}	\overline{WE} LOW to High-Z ^[9, 10]		20		25	ns
t _{LZWE}	\overline{WE} HIGH to Low-Z ^[9]	10		10		ns

Notes

8. Test conditions assume signal transition time of 5 ns or less, timing reference levels of $V_{CC(Typ)}/2$, input pulse levels of 0 to $V_{CC(Typ)}$, and output loading of the specified I_{OL}/I_{OH} and 30 pF load capacitance.
9. At any given temperature and voltage condition, t_{HZCE} is less than t_{LZCE}, t_{HZBE} is less than t_{LZBE}, t_{HZOE} is less than t_{LZOE}, and t_{HZWE} is less than t_{LZWE} for any given device.
10. t_{HZOE}, t_{HZCE}, t_{HZBE}, and t_{HZWE} transitions are measured when the output enters a high-impedance state.
11. If both byte enables are toggled together, this value is 10 ns.
12. The internal write time of the memory is defined by the overlap of \overline{WE} , $\overline{CE} = V_{IL}$, \overline{BHE} , and/or $\overline{BLE} = V_{IL}$. All signals must be ACTIVE to initiate a write and any of these signals can terminate a write by going INACTIVE. The data input setup and hold timing are referenced to the edge of the signal that terminates the write.

Switching Waveforms

Figure 4. Read Cycle 1: Address Transition Controlled [13, 14]

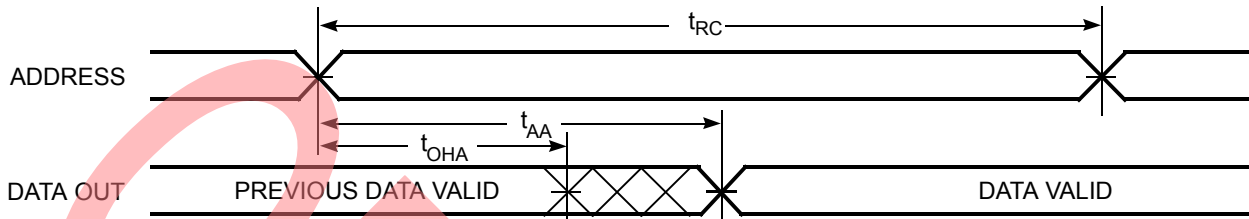
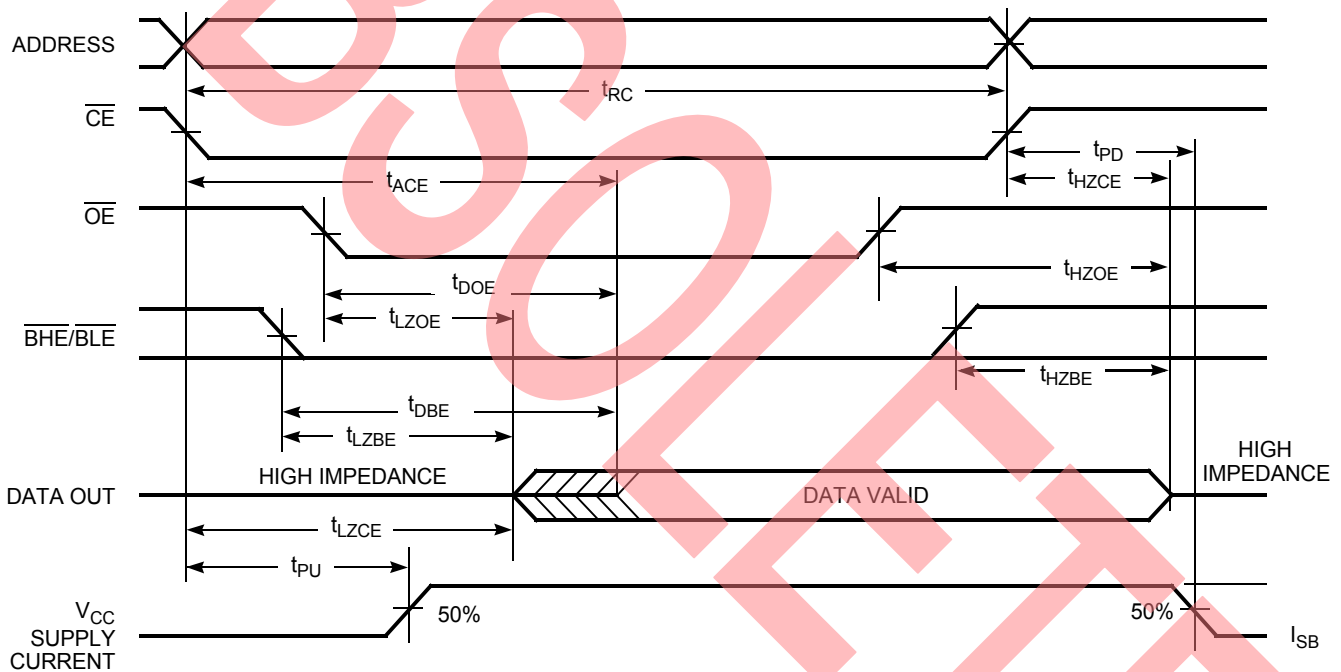

Figure 5. Read Cycle 2: \overline{OE} Controlled [14, 15]



Notes

13. The device is continuously selected. \overline{OE} , $\overline{CE} = V_{IL}$, \overline{BHE} and/or $\overline{BLE} = V_{IL}$.
14. \overline{WE} is HIGH for read cycle.
15. Address valid before or similar to \overline{CE} and \overline{BHE} , \overline{BLE} transition LOW.

Switching Waveforms (continued)

Figure 6. Write Cycle 1: \overline{WE} Controlled [12, 16, 17]

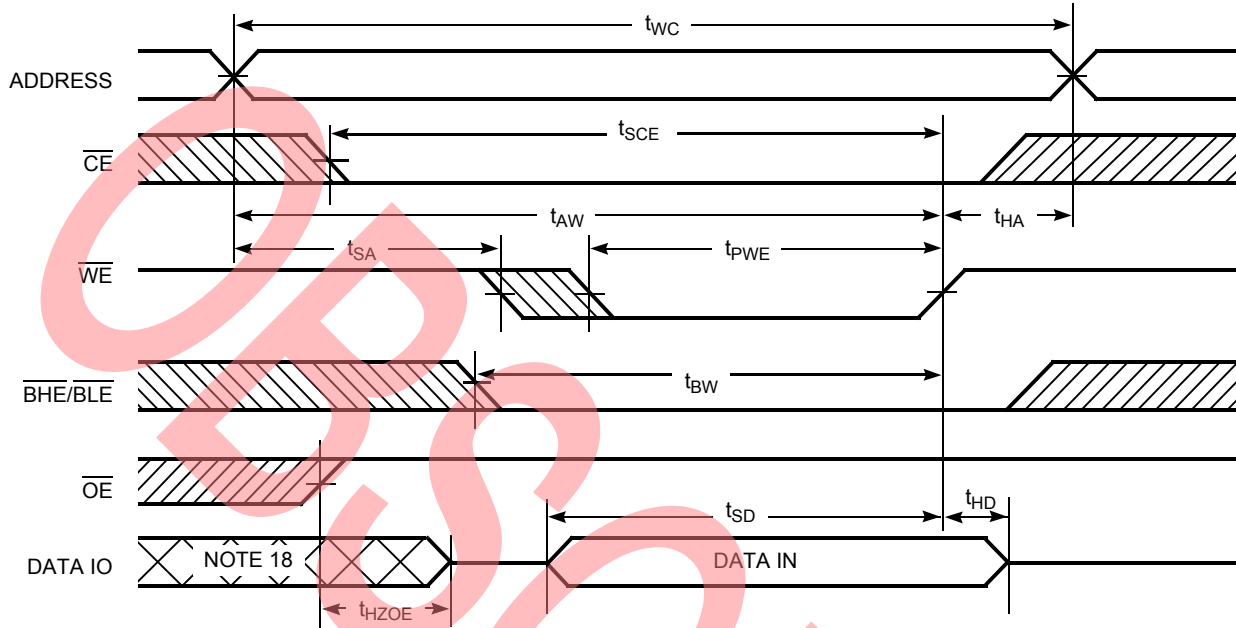
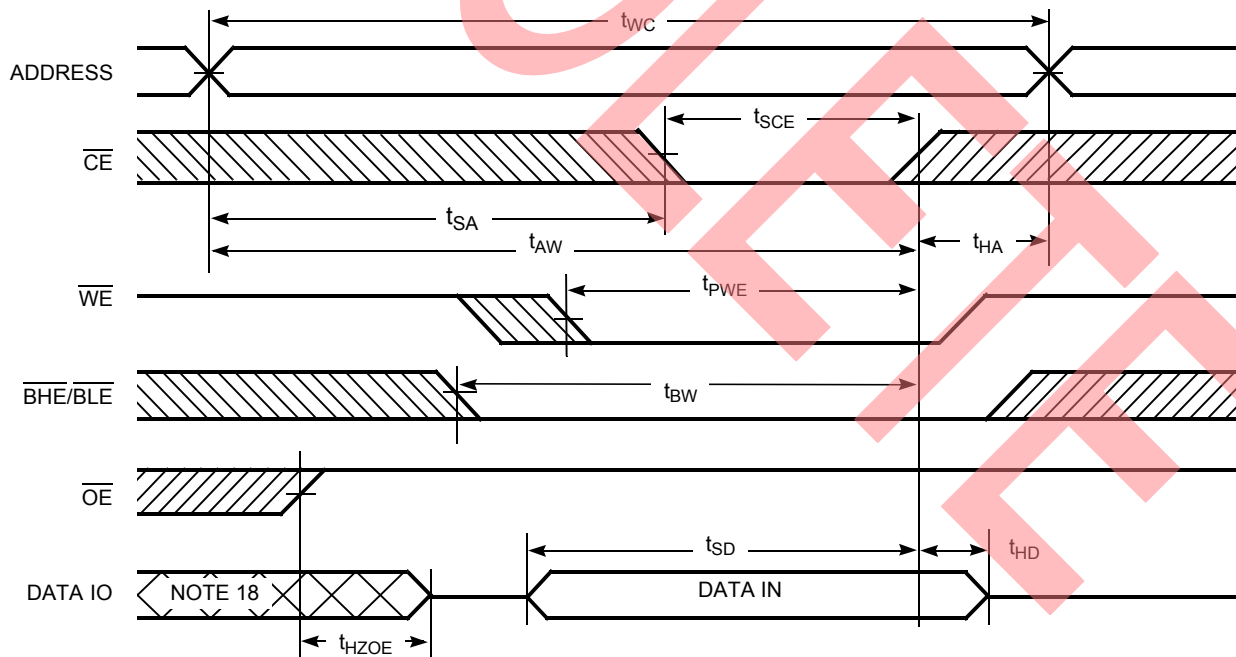

Figure 7. Write Cycle 2: \overline{CE} Controlled [12, 16, 17]



Notes

- 16. Data IO is high impedance if $\overline{OE} = V_{IH}$.
- 17. If CE goes HIGH simultaneously with $WE = V_{IH}$, the output remains in a high-impedance state.
- 18. During this period, the IOs are in an output state. Do not apply input signals.

Switching Waveforms (continued)

Figure 8. Write Cycle 3: \overline{WE} Controlled, \overline{OE} LOW ^[17]

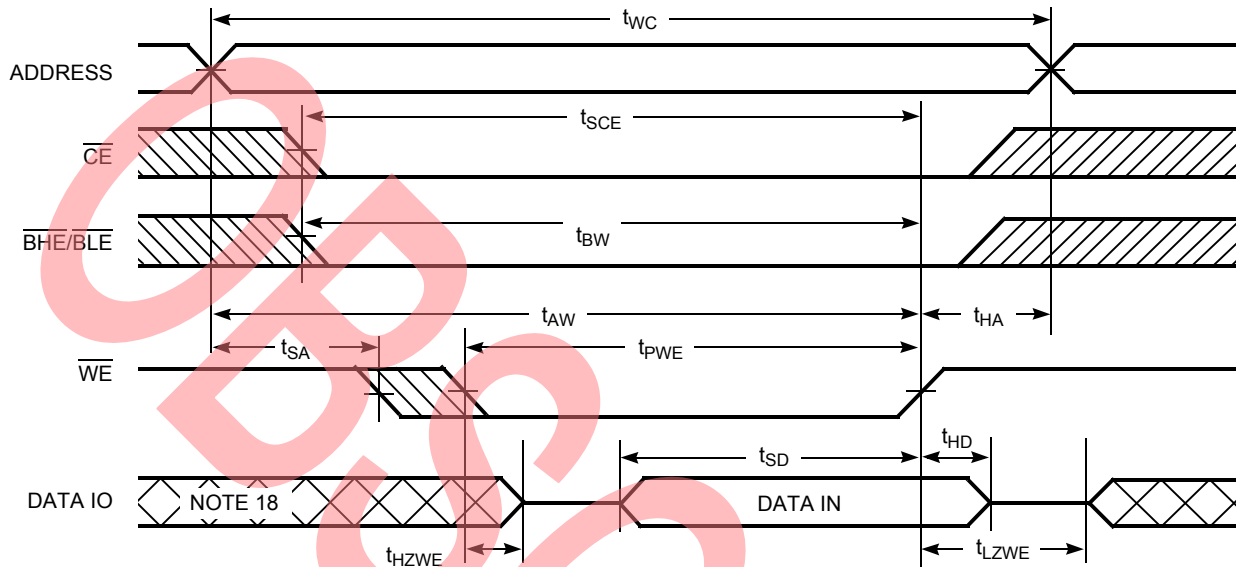
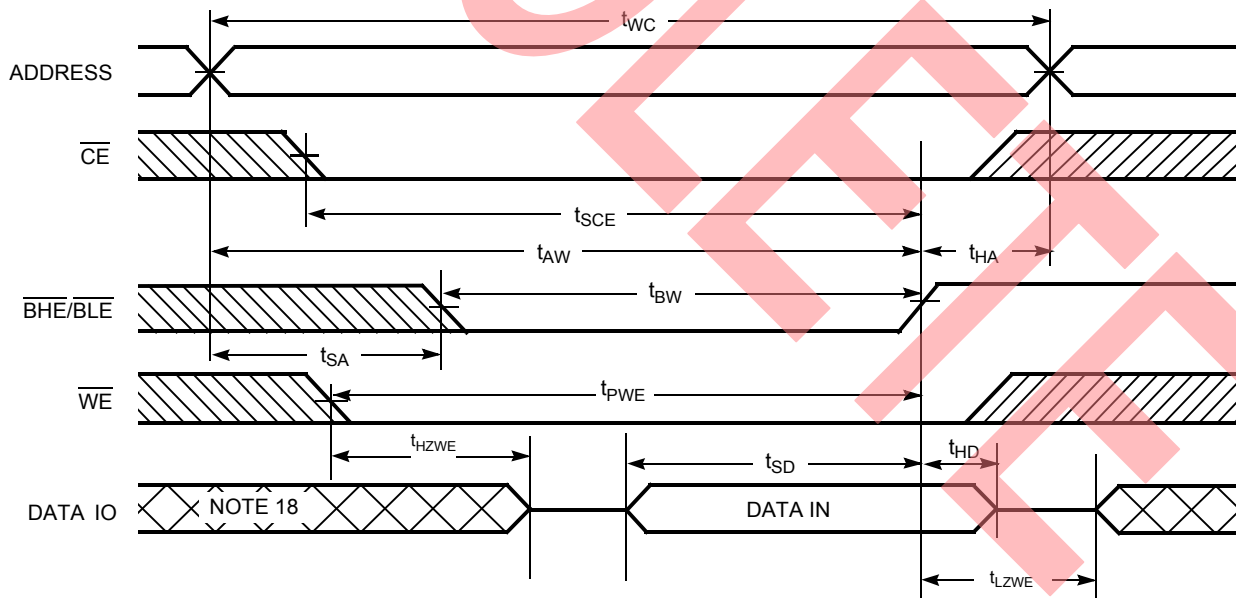

Figure 9. Write Cycle 4: $\overline{BHE}/\overline{BLE}$ Controlled, \overline{OE} LOW ^[17]



Truth Table

\overline{CE}	\overline{WE}	\overline{OE}	\overline{BHE}	\overline{BLE}	Inputs or Outputs	Mode	Power
H	X	X	X	X	High-Z	Deselect or Power Down	Standby (I_{SB})
X	X	X	H	H	High-Z	Deselect or Power Down	Standby (I_{SB})
L	H	L	L	L	Data Out (IO_0 – IO_{15})	Read	Active (I_{CC})
L	H	L	H	L	Data Out (IO_0 – IO_7); IO_8 – IO_{15} in High-Z	Read	Active (I_{CC})
L	H	L	L	H	Data Out (IO_8 – IO_{15}); IO_0 – IO_7 in High-Z	Read	Active (I_{CC})
L	H	H	L	L	High-Z	Output Disabled	Active (I_{CC})
L	H	H	H	L	High-Z	Output Disabled	Active (I_{CC})
L	H	H	L	H	High-Z	Output Disabled	Active (I_{CC})
L	L	X	L	L	Data In (IO_0 – IO_{15})	Write	Active (I_{CC})
L	L	X	H	L	Data In (IO_0 – IO_7); IO_8 – IO_{15} in High-Z	Write	Active (I_{CC})
L	L	X	L	H	Data In (IO_8 – IO_{15}); IO_0 – IO_7 in High-Z	Write	Active (I_{CC})

Ordering Information

Contact your local Cypress sales representative for availability of these parts

Speed (ns)	Ordering Code	Package Diagram	Package Type	Operating Range
55	CY62137CV30LL-55BVI	51-85150	48-ball FBGA (6 x 8 x 1 mm)	Industrial
	CY62137CV30LL-55BVXI		48-ball FBGA (6 x 8 x 1 mm), Pb-free	
	CY62137CV33LL-55BVI		48-ball FBGA (6 x 8 x 1 mm)	
70	CY62137CV30LL-70BAI	51-85096	48-ball FBGA (7 x 7 x 1.2 mm)	Industrial
	CY62137CV30LL-70BVI	51-85150	48-ball FBGA (6 x 8 x 1 mm)	
	CY62137CVSL-70BAI	51-85096	48-ball FBGA (7 x 7 x 1.2 mm)	
	CY62137CVSL-70BAXI		48-ball FBGA (7 x 7 x 1.2 mm), Pb-free	
	CY62137CV30LL-70BAE	51-85096	48-ball FBGA (7 x 7 x 1.2 mm)	Automotive
	CY62137CV30LL-70BVE	51-85150	48-ball FBGA (6 x 8 x 1 mm)	
	CY62137CV30LL-70BVXE		48-ball FBGA (6 x 8 x 1 mm), Pb-free	

Package Diagrams

Figure 10. 48-Ball FBGA (6 x 8 x 1 mm)

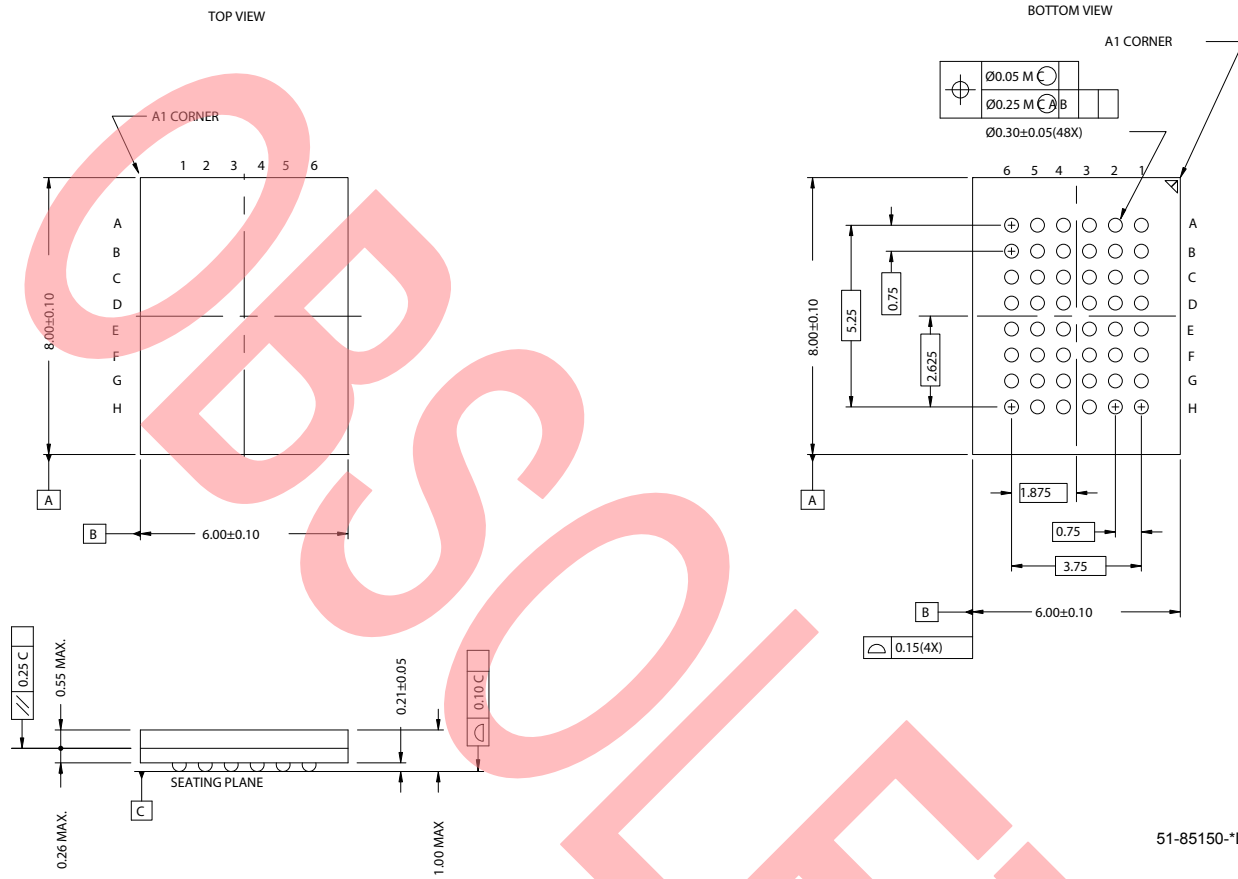

51-85150-D

Package Diagrams (continued)

Figure 11. 48-Ball FBGA (7 x 7 x 1.2 mm)

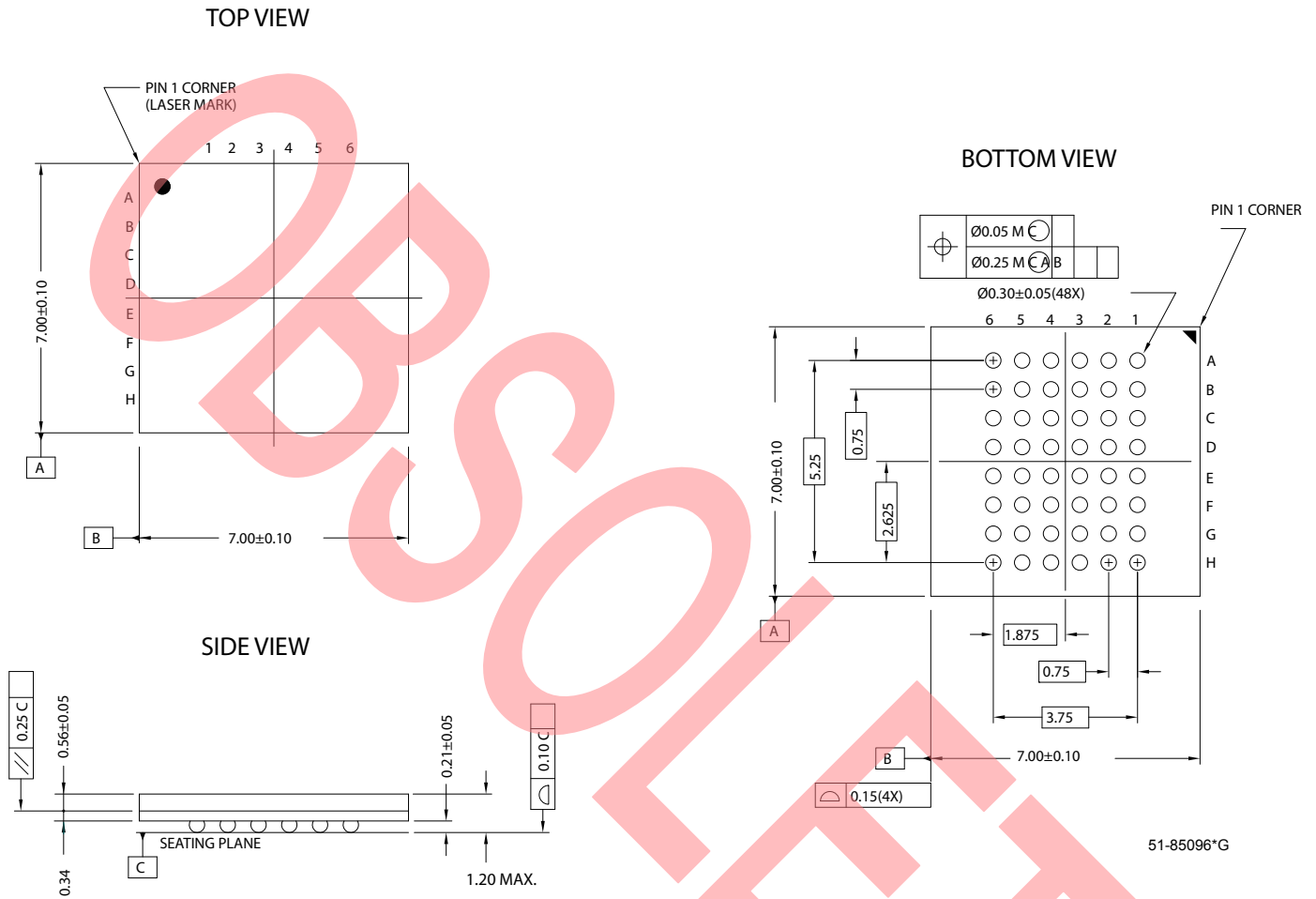

Document History Page

Document Title: CY62137CV30/33 MoBL [®] and CY62137CV MoBL 2-Mbit (128K x 16) Static RAM				
Document Number: 38-05201				
REV.	ECN NO.	Issue Date	Orig. of Change	Description of Change
**	112393	02/19/02	GAV	New Data Sheet (advance information)
*A	114015	04/25/02	JUI	Added BV package diagram Changed from Advance Information to Preliminary
*B	117064	07/12/02	MGN	Changed from Preliminary to Final
*C	118122	09/10/02	MGN	Added new part number: CY62137CV with wider voltage (2.7V – 3.6V) Added new SL power bin for new part number For T _{AA} = 55 ns, improved t _{PWE} min from 45 ns to 40 ns For T _{AA} = 70 ns, improved t _{PWE} min from 50 ns to 45 ns For T _{AA} = 70 ns, improved t _{LZWE} min from 5 ns to 10 ns
*D	118761	09/23/02	MGN	Improved Typ I _{CC} spec to 7 mA (for 55 ns) and 5.5 mA (for 70 ns) Improved Max I _{CC} spec to 15 mA (for 55 ns) and 12 mA (for 70 ns) For T _{AA} = 55 ns, improved t _{LZWE} min from 5 ns to 10 ns Changed upper spec for Supply Voltage to Ground Potential to V _{CC(Max)} + 0.5V Changed upper spec. for DC Voltage Applied to Outputs in High-Z State and DC Input Voltage to V _{CC} + 0.3V
*E	343877	See ECN	PCI	Added Automotive Information in Operating Range, DC, and Ordering Information Table
*F	419237	See ECN	ZSD	Changed the address of Cypress Semiconductor Corporation on Page 1 from “3901 North First Street” to “198 Champion Court” Updated the ordering information table and replaced the Package name column with Package diagram
*G	486789	See ECN	VKN	Removed part number CY62137CV25 from the product offering Updated the ordering information table
*H	1665045	See ECN	VKN/SFV	Changed V _{CC} range for CY7C62137CV from 2.7–3.6V to 2.9–3.6V
*I	2897923	03/23/10	RAME	Inactive parts; obsolete data sheet.

OBVIOUSLY
FOR

© Cypress Semiconductor Corporation, 2002-2010. The information contained herein is subject to change without notice. Cypress Semiconductor Corporation assumes no responsibility for the use of any circuitry other than circuitry embodied in a Cypress product. Nor does it convey or imply any license under patent or other rights. Cypress products are not warranted nor intended to be used for medical, life support, life saving, critical control or safety applications, unless pursuant to an express written agreement with Cypress. Furthermore, Cypress does not authorize its products for use as critical components in life-support systems where a malfunction or failure may reasonably be expected to result in significant injury to the user. The inclusion of Cypress products in life-support systems application implies that the manufacturer assumes all risk of such use and in doing so indemnifies Cypress against all charges.

Any Source Code (software and/or firmware) is owned by Cypress Semiconductor Corporation (Cypress) and is protected by and subject to worldwide patent protection (United States and foreign), United States copyright laws and international treaty provisions. Cypress hereby grants to licensee a personal, non-exclusive, non-transferable license to copy, use, modify, create derivative works of, and compile the Cypress Source Code and derivative works for the sole purpose of creating custom software and or firmware in support of licensee product to be used only in conjunction with a Cypress integrated circuit as specified in the applicable agreement. Any reproduction, modification, translation, compilation, or representation of this Source Code except as specified above is prohibited without the express written permission of Cypress.

Disclaimer: CYPRESS MAKES NO WARRANTY OF ANY KIND, EXPRESS OR IMPLIED, WITH REGARD TO THIS MATERIAL, INCLUDING, BUT NOT LIMITED TO, THE IMPLIED WARRANTIES OF MERCHANTABILITY AND FITNESS FOR A PARTICULAR PURPOSE. Cypress reserves the right to make changes without further notice to the materials described herein. Cypress does not assume any liability arising out of the application or use of any product or circuit described herein. Cypress does not authorize its products for use as critical components in life-support systems where a malfunction or failure may reasonably be expected to result in significant injury to the user. The inclusion of Cypress' product in a life-support systems application implies that the manufacturer assumes all risk of such use and in doing so indemnifies Cypress against all charges.

Use may be limited by and subject to the applicable Cypress software license agreement.