

FEATURES

Passive, wideband I/Q mixer

RF and LO range: 20 GHz to 42 GHz

Wide IF bandwidth of dc to 5 GHz

Single-ended RF, LO, and IF

Conversion loss: 9 dB typical, 20 GHz to 32 GHz

Image rejection: 25 dBc typical, 20 GHz to 32 GHz

Noise figure: 12 dB typical

Input IP3 (downconverter): 24 dBm typical, 20 GHz to 32 GHz

Input P1dB (downconverter) compression: 17 dBm typical,
20 GHz to 32 GHz

Input IP2: 55 dBm typical, 20 GHz to 32 GHz

LO to RF isolation: 42 dB, 20 GHz to 32 GHz

LO to IFx isolation: 45 dB, 20 GHz to 32 GHz

RF to IF isolation: 35 dB, 20 GHz to 32 GHz

Amplitude balance: ± 1 dB typical

Phase balance (downconverter): $\pm 8^\circ$ typical

RF return loss: 12 dB typical

LO return loss: 10 dB typical

IFx return loss: 20 dB typical

Exposed pad, 4.00 mm \times 4.00 mm, 25-terminal LGA_CAV
package

APPLICATIONS

Test and measurement instrumentation

Military, radar, aerospace, and defense applications

Microwave point to point base stations

GENERAL DESCRIPTION

The HMC8192LG is a passive, wideband, inphase/quadrature (I/Q), monolithic microwave integrated circuit (MMIC) mixer that can be used either as an image rejection mixer for receiver operations or as a single-sideband upconverter for transmitter operations. With a radio frequency (RF) and local oscillator (LO) range of 20 GHz to 42 GHz, and an intermediate frequency (IF) bandwidth of dc to 5 GHz, the HMC8192LG is ideal for applications requiring a wide frequency range, excellent RF performance, and a simple design with fewer components and a small printed circuit board (PCB) footprint. A single HMC8192LG can replace multiple narrow-band mixers in a design.

The inherent I/Q architecture of the HMC8192LG offers excellent image rejection, eliminating the need for expensive filtering for unwanted sidebands. The mixer also provides

FUNCTIONAL BLOCK DIAGRAM

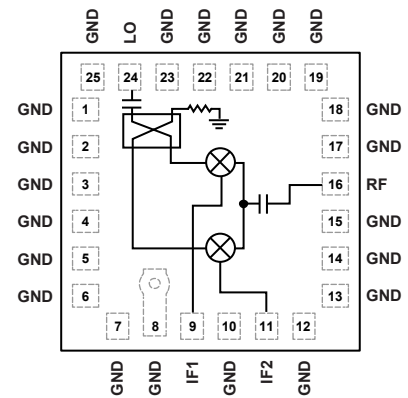

Figure 1.

excellent LO to RF and LO to IF isolation and reduces the effect of LO leakage to ensure signal integrity.

As a passive mixer, the HMC8192LG does not require any dc power sources. The HMC8192LG offers a lower noise figure compared to an active mixer, ensuring superior dynamic range for high performance and precision applications.

The HMC8192LG is fabricated on a gallium arsenide (GaAs), metal semiconductor field effect transistor (MESFET) process and uses Analog Devices, Inc., mixer cells and a 90° hybrid. The HMC8192LG is available in a compact, 4.00 mm \times 4.00 mm, 25-terminal land grid array cavity (LGA_CAV) package and operates over a -40°C to $+85^\circ\text{C}$ temperature range. The evaluation board for the HMC8192LG, [EV1HMC8192LG](#), is also available on the Analog Devices website.

Rev. 0

[Document Feedback](#)

Information furnished by Analog Devices is believed to be accurate and reliable. However, no responsibility is assumed by Analog Devices for its use, nor for any infringements of patents or other rights of third parties that may result from its use. Specifications subject to change without notice. No license is granted by implication or otherwise under any patent or patent rights of Analog Devices. Trademarks and registered trademarks are the property of their respective owners.

TABLE OF CONTENTS

| | | | |
|--|----|--|----|
| Features | 1 | Upconverter Performance: IF = 2500 MHz, Upper Sideband... | 19 |
| Applications | 1 | Upconverter Performance: IF = 5000 MHz, Upper Sideband | 21 |
| Functional Block Diagram | 1 | Upconverter Performance: IF = 2500 MHz, Lower Sideband | 23 |
| General Description | 1 | Upconverter Performance: IF = 5000 MHz, Lower Sideband | 25 |
| Revision History | 2 | Isolation and Return Loss Without External 90° Hybrid at the IFx Ports | 27 |
| Specifications..... | 3 | IF Bandwidth Performance: Downconverter, Upper Sideband (Low-Side LO) | 29 |
| 20 GHz to 32 GHz | 3 | IF Bandwidth Performance: Downconverter, Lower Sideband (High-Side LO) | 30 |
| 32 GHz to 42 GHz | 4 | Amplitude and Phase Imbalance Performance: Downconverter, Upper Sideband (Low-Side LO) | 31 |
| Absolute Maximum Ratings..... | 5 | Spurious and Harmonics Performance | 32 |
| Thermal Resistance | 5 | Theory of Operation | 37 |
| ESD Caution..... | 5 | Applications Information | 38 |
| Pin Configuration and Function Descriptions..... | 6 | Layout | 38 |
| Interface Schematics..... | 6 | Evaluation Board Information | 38 |
| Typical Performance Characteristics | 7 | Performance at Lower IF Frequencies..... | 39 |
| Downconverter Performance: IF = 100 MHz, Upper Sideband (Low-Side LO) | 7 | Performance at Higher IF Frequencies..... | 39 |
| Downconverter Performance: IF = 2500 MHz, Upper Sideband (Low-Side LO) | 9 | Outline Dimensions | 40 |
| Downconverter Performance: IF = 5000 MHz, Upper Sideband (Low-Side LO) | 11 | Ordering Guide | 40 |
| Downconverter Performance: IF = 2500 MHz, Lower Sideband (High-Side LO)..... | 13 | | |
| Downconverter Performance: IF = 5000 MHz, Lower Sideband (High-Side LO)..... | 15 | | |
| Upconverter Performance: IF = 100 MHz, Upper Sideband..... | 17 | | |

REVISION HISTORY

11/2019—Revision 0: Initial Version

SPECIFICATIONS

20 GHz TO 32 GHz

$T_A = 25^\circ\text{C}$, IF = 100 MHz, LO drive = 18 dBm, all measurements performed as downconverter with upper sideband selected, external 90° hybrid at the IFx ports, and LO amplifier in line with lab bench LO source, unless otherwise noted.

Table 1.

| Parameter | Symbol | Min | Typ | Max | Unit |
|--------------------------------------|----------|-----|-----|-----|---------|
| FREQUENCY | | | | | |
| Radio | RF | 20 | | 32 | GHz |
| LO | f_{LO} | 20 | | 32 | GHz |
| Intermediate | IF | dc | | 5 | GHz |
| LO DRIVE LEVEL | | | | | |
| | | 16 | 18 | 20 | dBm |
| RF PERFORMANCE AS DOWNCONVERTER | | | | | |
| Conversion Loss | | | 9 | 10 | dB |
| Image Rejection | | 15 | 25 | | dBc |
| Single-Sideband Noise Figure | SSB NF | | 12 | | dB |
| Input Third-Order Intercept | IP3 | 22 | 24 | | dBm |
| Input 1 dB Compression Point | P1dB | | 17 | | dBm |
| Input Second-Order Intercept | IP2 | | 55 | | dBm |
| Amplitude Balance ¹ | | | ±1 | | dB |
| Phase Balance ¹ | | | ±8 | | Degrees |
| RF PERFORMANCE AS UPCONVERTER | | | | | |
| Conversion Loss | | | 9 | | dB |
| Sideband Rejection | | | 18 | | dBc |
| Input Third-Order Intercept | IP3 | | 21 | | dBm |
| Input 1 dB Compression Point | P1dB | | 14 | | dBm |
| ISOLATION PERFORMANCE | | | | | |
| LO to RF | | 36 | 42 | | dB |
| LO to IFx ¹ | | | 45 | | dB |
| RF to IF ¹ | | | 35 | | dB |
| RETURN LOSS PERFORMANCE ¹ | | | | | |
| RF | | | 12 | | dB |
| LO | | | 10 | | dB |
| IFx | | | 20 | | dB |

¹ Measurements taken without 90° hybrid at the IFx ports.

32 GHz TO 42 GHz

$T_A = 25^\circ\text{C}$, IF = 100 MHz, LO drive = 18 dBm, all measurements performed as downconverter with upper sideband selected, external 90° hybrid at the IFx ports, and LO amplifier in line with lab bench LO source, unless otherwise noted.

Table 2.

| Parameter | Symbol | Min | Typ | Max | Unit |
|--|----------|-----|---------|-----|---------|
| FREQUENCY | | | | | |
| Radio | RF | 32 | | 42 | GHz |
| LO | f_{LO} | 32 | | 42 | GHz |
| Intermediate | IF | dc | | 5 | GHz |
| LO DRIVE LEVEL | | | | | |
| | | 16 | 18 | 20 | dBm |
| RF PERFORMANCE AS DOWNCONVERTER | | | | | |
| Conversion Loss | | | 11 | 15 | dB |
| Image Rejection | | 15 | 20 | | dBc |
| Single-Sideband Noise Figure | SSB NF | | 12 | | dB |
| Input Third-Order Intercept | IP3 | 17 | 23 | | dBm |
| Input 1 dB Compression Point | P1dB | | 18 | | dBm |
| Input Second-Order Intercept | IP2 | | 50 | | dBm |
| Amplitude Balance ¹ | | | ± 1 | | dB |
| Phase Balance ¹ | | | ± 8 | | Degrees |
| RF PERFORMANCE AS UPCONVERTER | | | | | |
| Conversion Loss | | | 10 | | dB |
| Sideband Rejection | | | 18 | | dBc |
| Input Third-Order Intercept | IP3 | | 20 | | dBm |
| Input 1 dB Compression Point | P1dB | | 14 | | dBm |
| ISOLATION PERFORMANCE | | | | | |
| LO to RF | | 24 | 42 | | dB |
| LO to IFx ¹ | | | 43 | | dB |
| RF to IF ¹ | | | 40 | | dB |
| RETURN LOSS PERFORMANCE¹ | | | | | |
| RF | | | 12 | | dB |
| LO | | | 10 | | dB |
| IFx | | | 20 | | dB |

¹ Measurements taken without 90° hybrid at the IFx ports.

ABSOLUTE MAXIMUM RATINGS

Table 3.

| Parameter | Rating |
|--|---|
| RF Input Power | 23 dBm |
| LO Input Power | 23 dBm |
| IF Input Power | 23 dBm |
| IF Source/Sink Current | 3 mA |
| Continuous Power Dissipation, P_{DISS} ($T_A = 85^\circ\text{C}$, Derate 7.2 mW/ $^\circ\text{C}$ Above 85°C) ¹ | 647 mW |
| Maximum Junction Temperature (T_J) | 175 $^\circ\text{C}$ |
| Lifetime at Maximum T_J | $>1 \times 10^6$ hours |
| Moisture Sensitivity Level (MSL) ² | 3 |
| Maximum Peak Reflow Temperature (MLS3) | 260 $^\circ\text{C}$ |
| Operating Temperature Range | -40 $^\circ\text{C}$ to +85 $^\circ\text{C}$ |
| Storage Temperature Range | -65 $^\circ\text{C}$ to +150 $^\circ\text{C}$ |
| Electrostatic Discharge Sensitivity | |
| Human Body Model | 4000 V |
| Field Induced Charged Device Model | 1250 V |

¹ P_{DISS} is a theoretical number calculated by $(T_J - 85^\circ\text{C})/\theta_{JC}$.

² Based on IPC/JEDEC J-STD-20 MSL classifications.

Stresses at or above those listed under Absolute Maximum Ratings may cause permanent damage to the product. This is a stress rating only; functional operation of the product at these or any other conditions above those indicated in the operational section of this specification is not implied. Operation beyond the maximum operating conditions for extended periods may affect product reliability.

THERMAL RESISTANCE

Thermal performance is directly linked to printed circuit board (PCB) design and operating environment. Careful attention to PCB thermal design is required.

θ_{JA} is the junction to ambient (or die to ambient) thermal resistance measured in a one cubic foot sealed enclosure, and θ_{JC} is the junction to case (or die to package) thermal resistance.

Table 4. Thermal Resistance

| Package Type | θ_{JA} | θ_{JC} | Unit |
|----------------------|---------------|---------------|---------------------------|
| CE-25-1 ¹ | 120 | 139 | $^\circ\text{C}/\text{W}$ |

¹ Thermal impedance simulated values are based on a JEDEC 252P test board with 4×4 thermal vias. Refer to JEDEC standard JESD51-2 for additional information.

ESD CAUTION



ESD (electrostatic discharge) sensitive device.

Charged devices and circuit boards can discharge without detection. Although this product features patented or proprietary protection circuitry, damage may occur on devices subjected to high energy ESD. Therefore, proper ESD precautions should be taken to avoid performance degradation or loss of functionality.

PIN CONFIGURATION AND FUNCTION DESCRIPTIONS

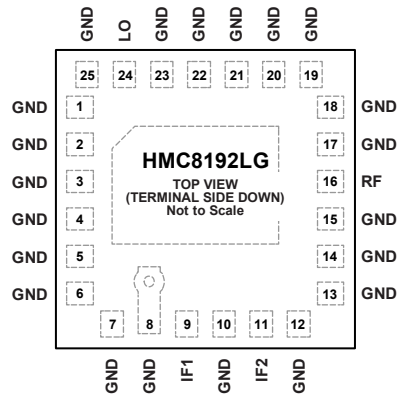

NOTES
 1. EXPOSED PAD. THE EXPOSED PAD MUST BE CONNECTED TO RF/DC GROUND.

15697-002

Figure 2. Pin Configuration

Table 5. Pin Function Descriptions

| Pin No. | Mnemonic | Description |
|------------------------------------|----------|--|
| 1 to 8, 10, 12 to 15, 17 to 23, 25 | GND | Ground Connections. These pins and the package bottom must be connected to RF/dc ground. See Figure 3 for the interface schematic. |
| 9, 11 | IF1, IF2 | First and Second Quadrature IF Input/Output Pins. These pins are dc-coupled. For applications not requiring operation to dc, use an off-chip dc blocking capacitor. For operations to dc, these pins must not source or sink more than 3 mA of current. Otherwise, the device may not function and may fail. See Figure 4 for the interface schematic. |
| 16 | RF | RF Input/Output. This pin is ac-coupled and matched to 50 Ω. See Figure 5 for the interface schematic. |
| 24 | LO | LO Input. This pin is ac-coupled and matched to 50 Ω. See Figure 6 for the interface schematic. |
| | EPAD | Exposed Pad. The exposed pad must be connected to RF/dc ground. |

INTERFACE SCHEMATICS



Figure 3. GND Interface Schematic

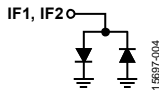

Figure 4. IF1 and IF2 Interface Schematic

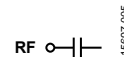

Figure 5. RF Interface Schematic

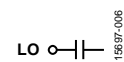

Figure 6. LO Interface Schematic

TYPICAL PERFORMANCE CHARACTERISTICS

DOWNCONVERTER PERFORMANCE: IF = 100 MHz, UPPER SIDEBAND (LOW-SIDE LO)

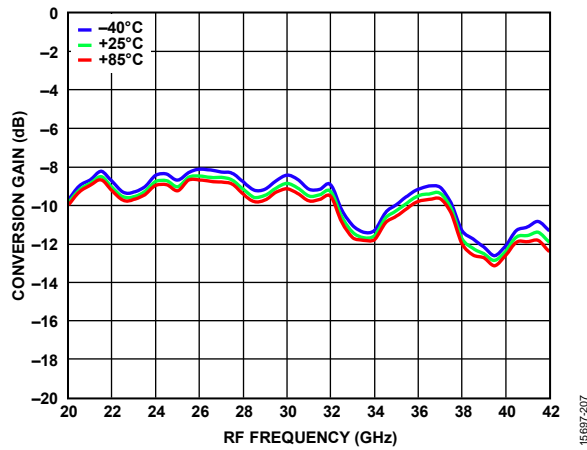

Figure 7. Conversion Gain vs. RF Frequency at Various Temperatures, LO Drive = 18 dBm

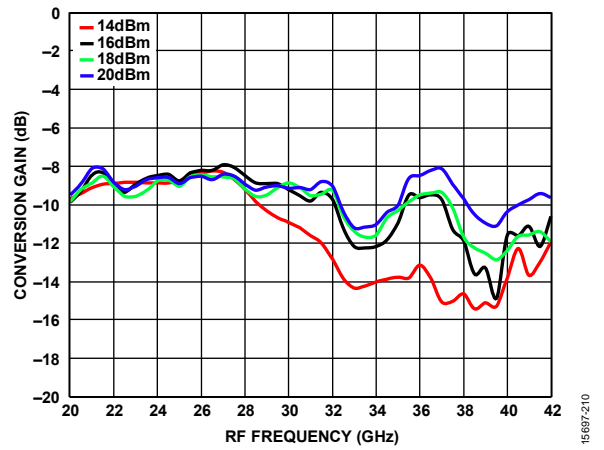

Figure 10. Conversion Gain vs. RF Frequency at Various LO Drives, $T_A = 25^\circ\text{C}$

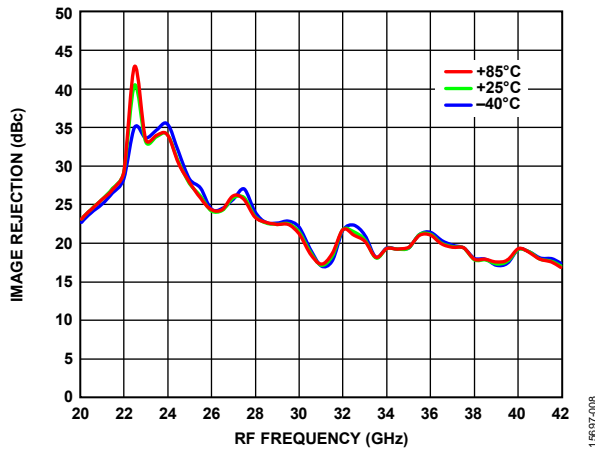

Figure 8. Image Rejection vs. RF Frequency at Various Temperatures, LO Drive = 18 dBm

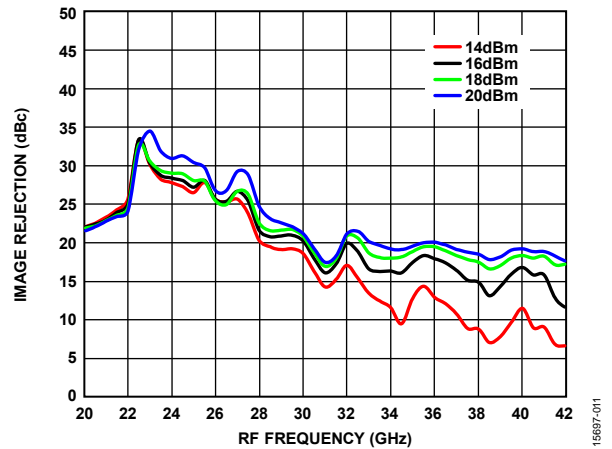

Figure 11. Image Rejection vs. RF Frequency at Various LO Drives, $T_A = 25^\circ\text{C}$

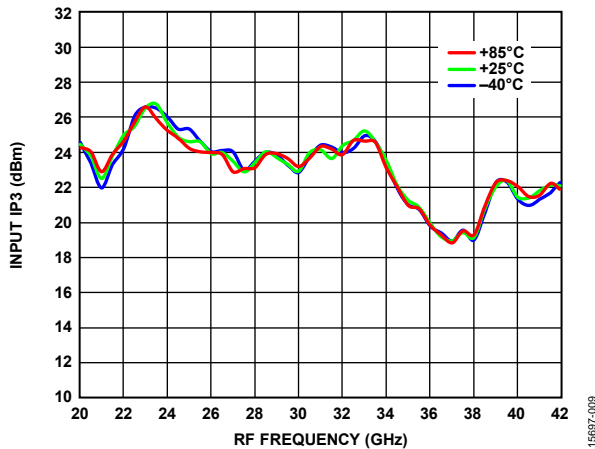

Figure 9. Input IP3 vs. RF Frequency at Various Temperatures, LO Drive = 18 dBm

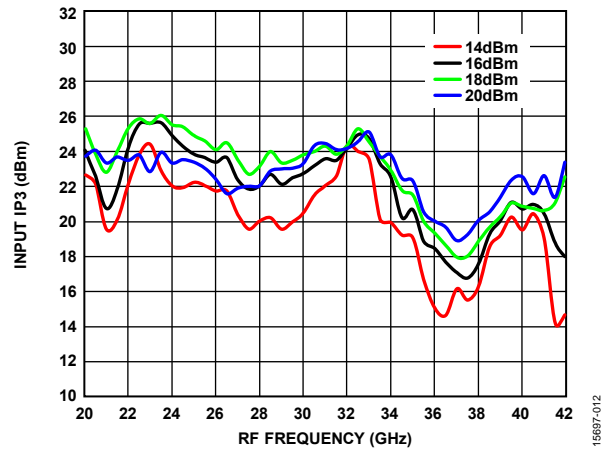

Figure 12. Input IP3 vs. RF Frequency at Various LO Drives, $T_A = 25^\circ\text{C}$

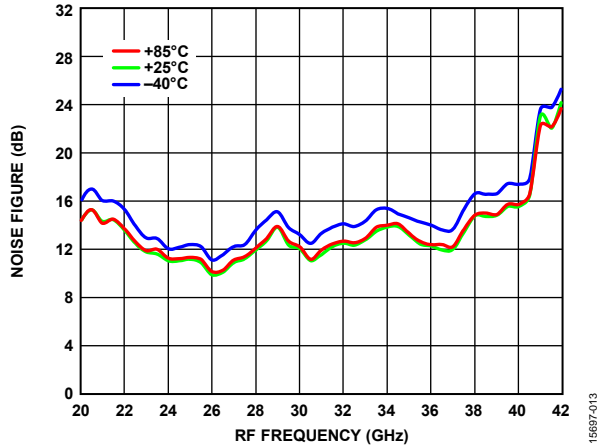

Figure 13. Noise Figure vs. RF Frequency at Various Temperatures, LO Drive = 18 dBm

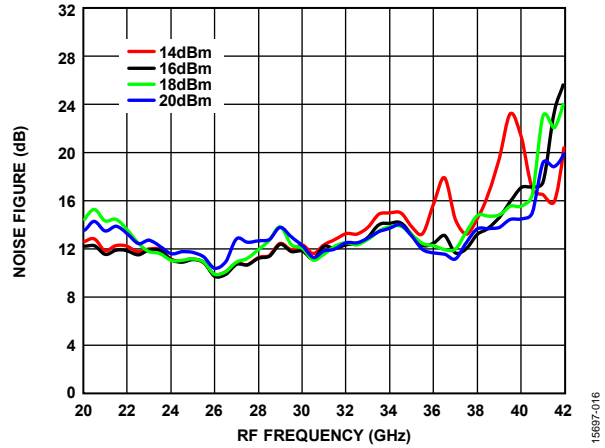

Figure 16. Noise Figure vs. RF Frequency at Various LO Drives, $T_A = 25^\circ\text{C}$

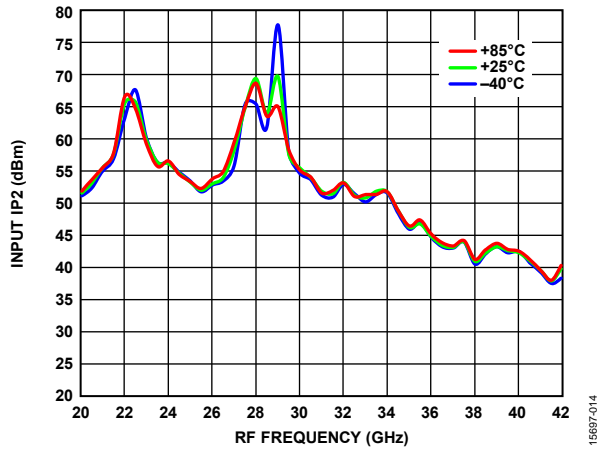

Figure 14. Input IP2 vs. RF Frequency at Various Temperatures, LO Drive = 18 dBm

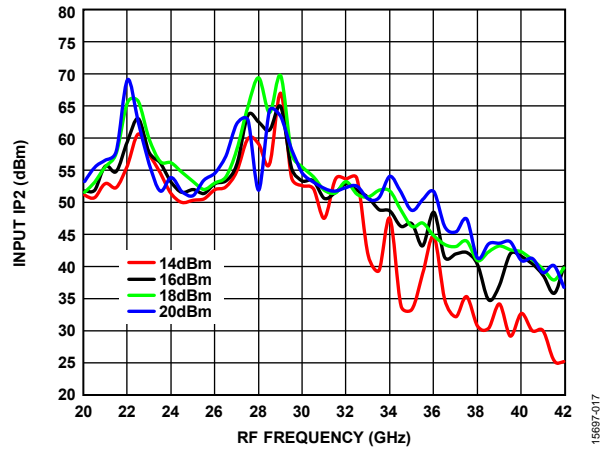

Figure 17. Input IP2 vs. RF Frequency at Various LO Drives, $T_A = 25^\circ\text{C}$

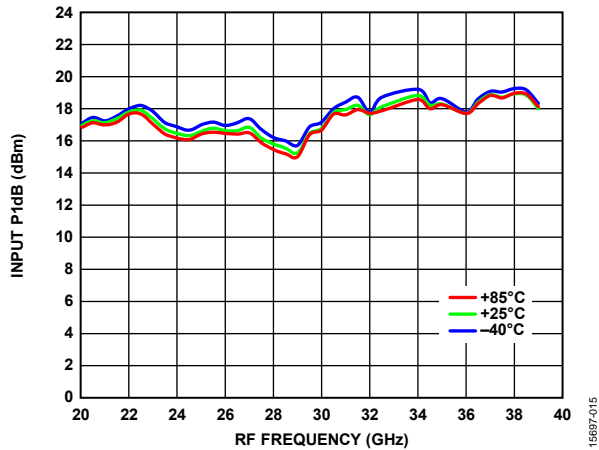

Figure 15. Input P1dB vs. RF Frequency at Various Temperatures, LO Drive = 18 dBm

15687-013

15687-016

15687-014

15687-017

15687-015

DOWNCONVERTER PERFORMANCE: IF = 2500 MHz, UPPER SIDEBAND (LOW-SIDE LO)

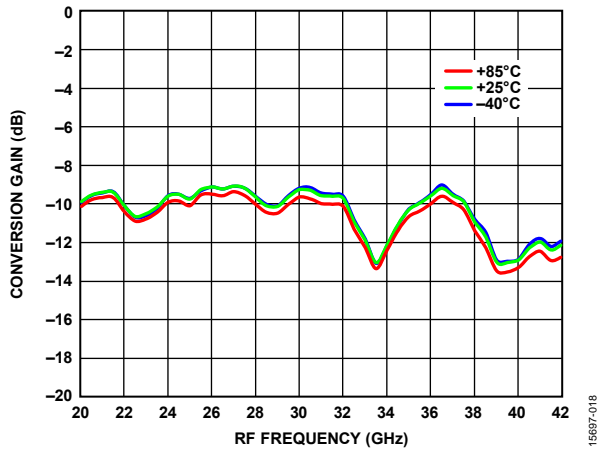

Figure 18. Conversion Gain vs. RF Frequency at Various Temperatures, LO Drive = 18 dBm

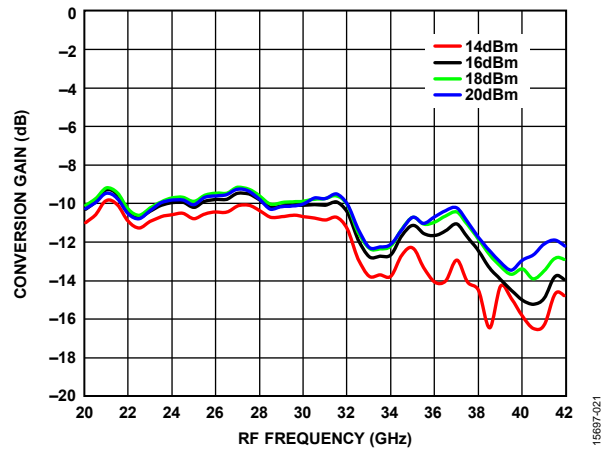

Figure 21. Conversion Gain vs. RF Frequency at Various LO Drives, $T_A = 25^\circ\text{C}$

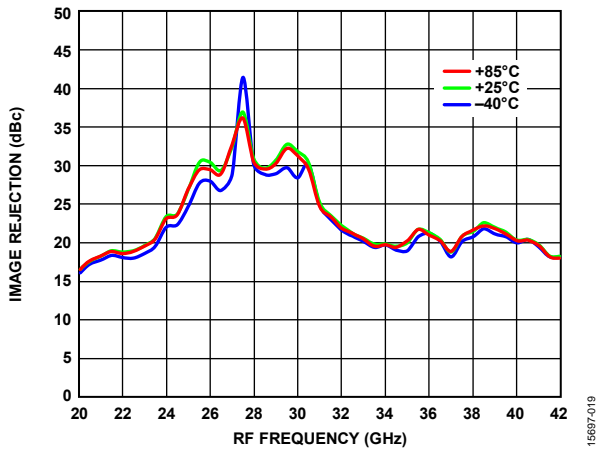

Figure 19. Image Rejection vs. RF Frequency at Various Temperatures, LO Drive = 18 dBm

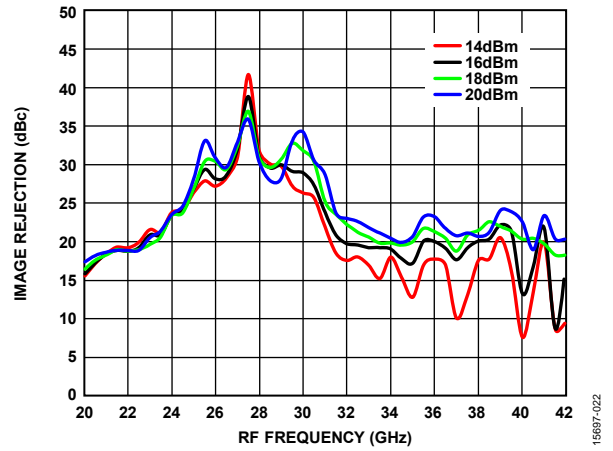

Figure 22. Image Rejection vs. RF Frequency at Various LO Drives, $T_A = 25^\circ\text{C}$

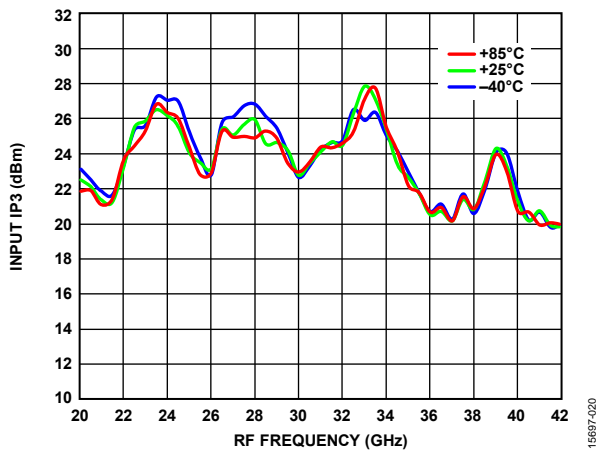

Figure 20. Input IP3 vs. RF Frequency at Various Temperatures, LO Drive = 18 dBm

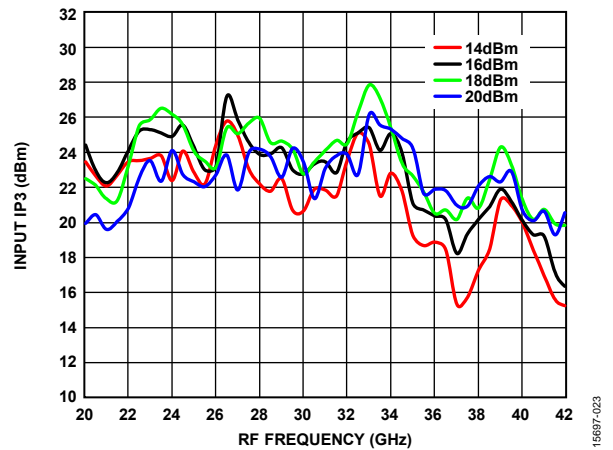

Figure 23. Input IP3 vs. RF Frequency at Various LO Drives, $T_A = 25^\circ\text{C}$

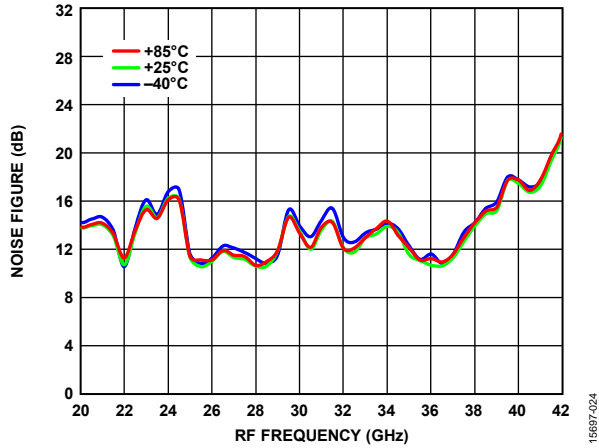

Figure 24. Noise Figure vs. RF Frequency at Various Temperatures, LO Drive = 18 dBm

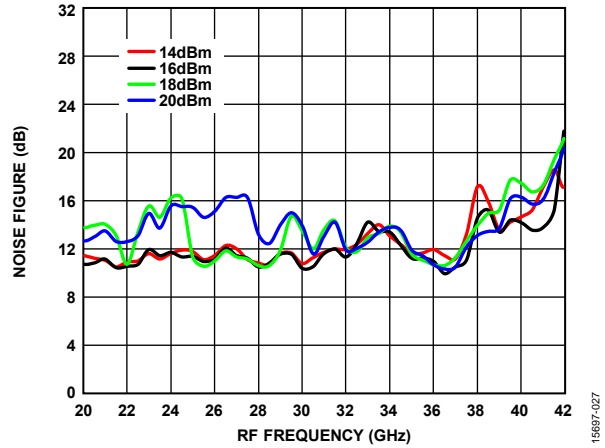

Figure 27. Noise Figure vs. RF Frequency at Various LO Drives, $T_A = 25^\circ\text{C}$

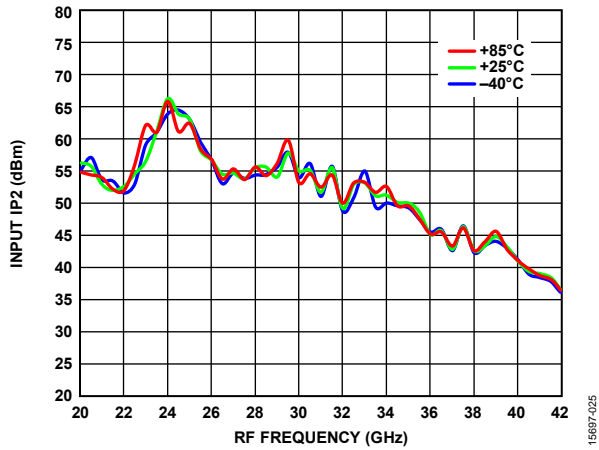

Figure 25. Input IP2 vs. RF Frequency at Various Temperatures, LO Drive = 18 dBm

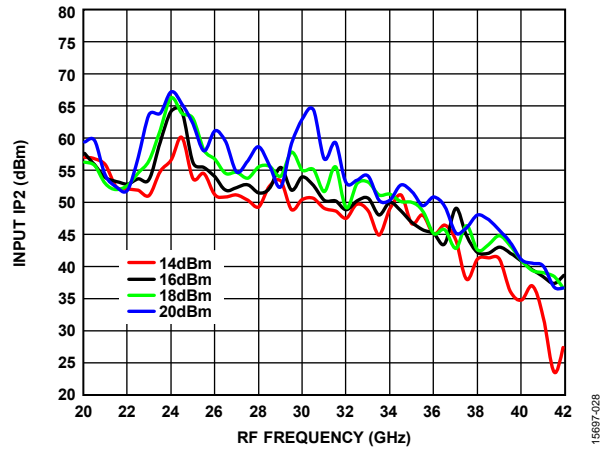

Figure 28. Input IP2 vs. RF Frequency at Various LO Drives, $T_A = 25^\circ\text{C}$

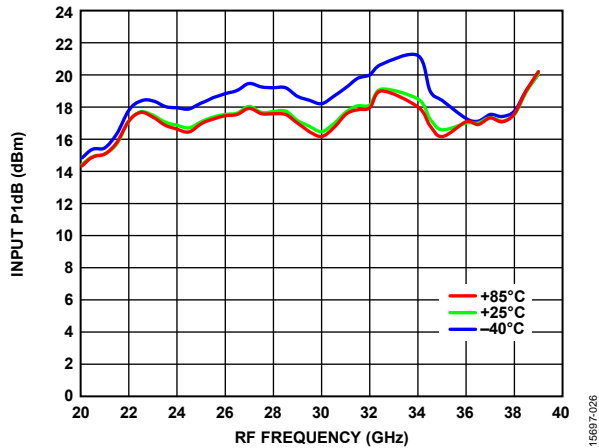

Figure 26. Input P1dB vs. RF Frequency at Various Temperatures, LO Drive = 18 dBm

156697-024

156697-027

156697-025

156697-028

156697-026

DOWNCONVERTER PERFORMANCE: IF = 5000 MHz, UPPER SIDEBAND (LOW-SIDE LO)

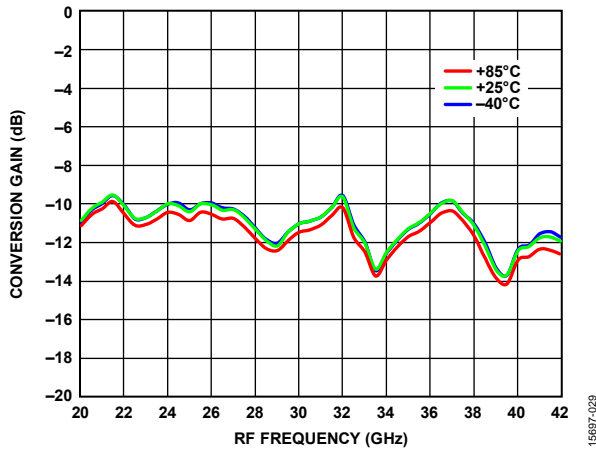

Figure 29. Conversion Gain vs. RF Frequency at Various Temperatures, LO Drive = 18 dBm

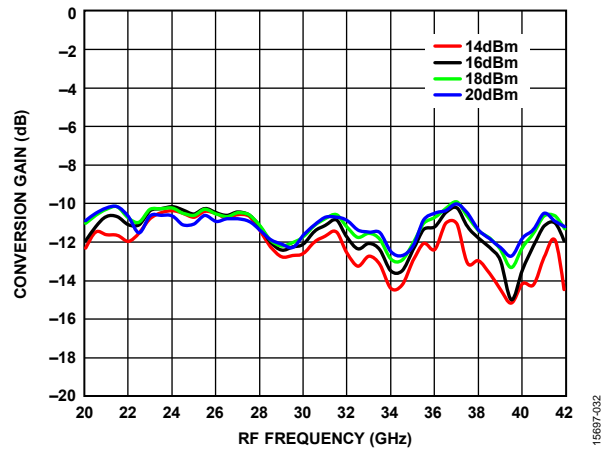

Figure 32. Conversion Gain vs. RF Frequency at Various LO Drives, $T_A = 25^\circ\text{C}$

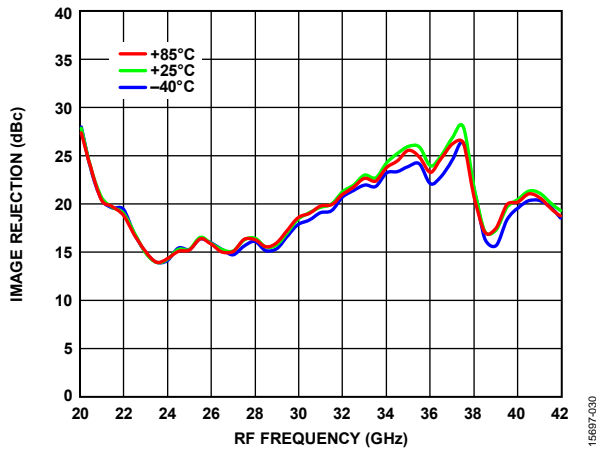

Figure 30. Image Rejection vs. RF Frequency at Various Temperatures, LO Drive = 18 dBm

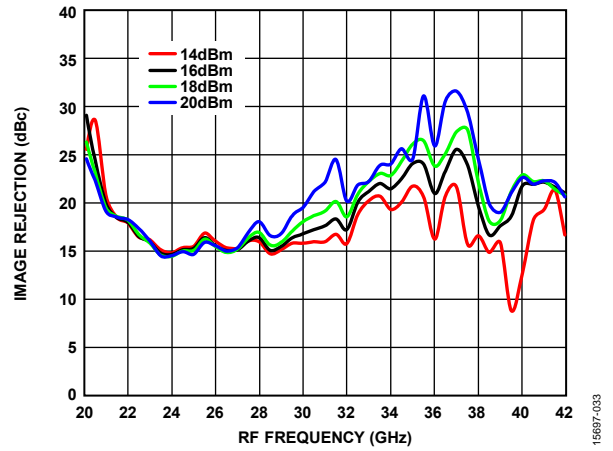

Figure 33. Image Rejection vs. RF Frequency at Various LO Drives, $T_A = 25^\circ\text{C}$

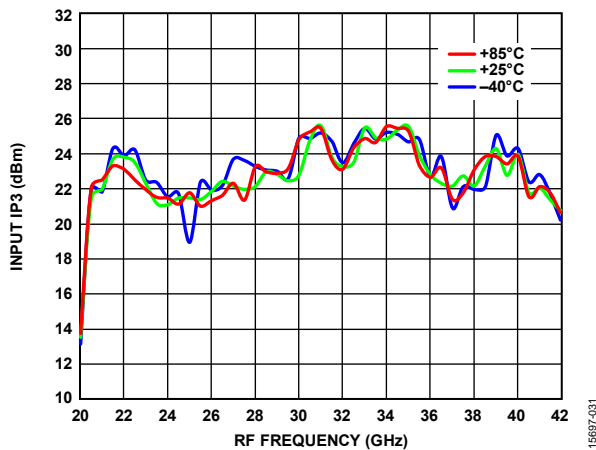

Figure 31. Input IP3 vs. RF Frequency at Various Temperatures, LO Drive = 18 dBm

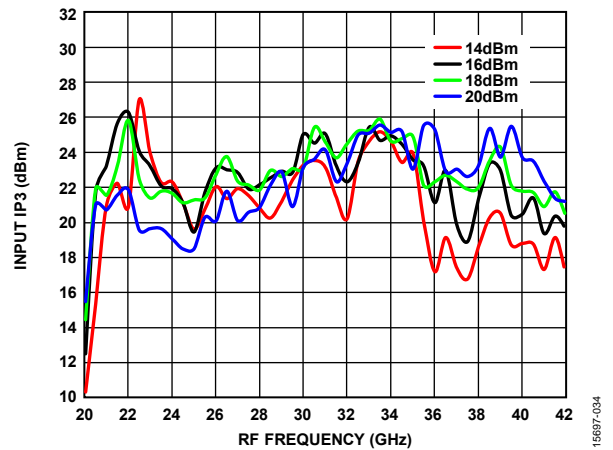

Figure 34. Input IP3 vs. RF Frequency at Various LO Drives, $T_A = 25^\circ\text{C}$

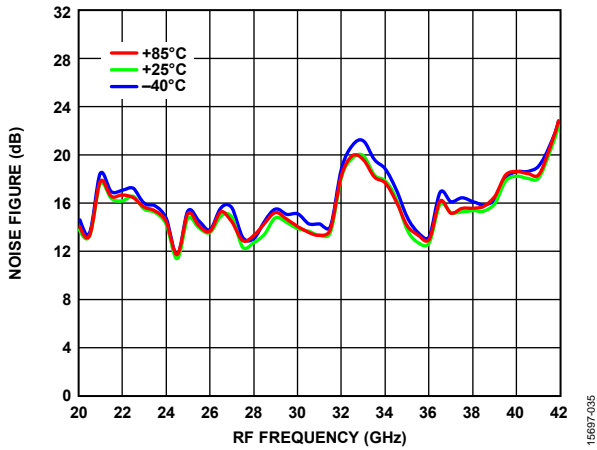

Figure 35. Noise Figure vs. RF Frequency at Various Temperatures, LO Drive = 18 dBm

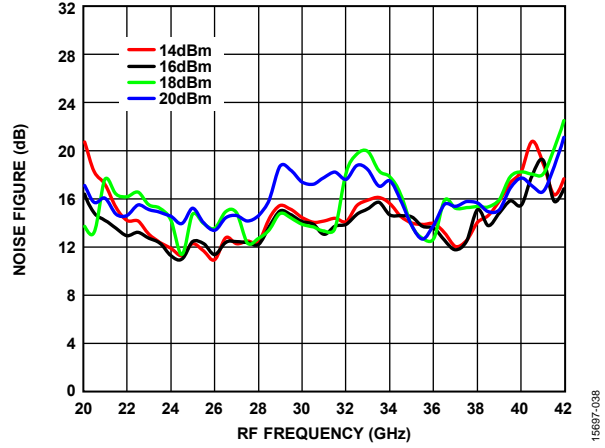

Figure 38. Noise Figure vs. RF Frequency at Various LO Drives, $T_A = 25^\circ\text{C}$

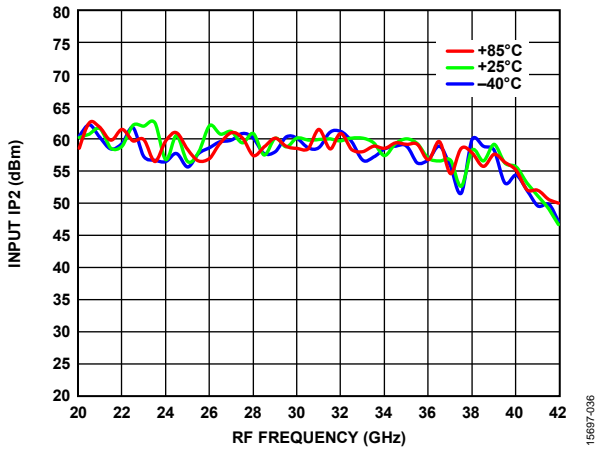

Figure 36. Input IP2 vs. RF Frequency at Various Temperatures, LO Drive = 18 dBm

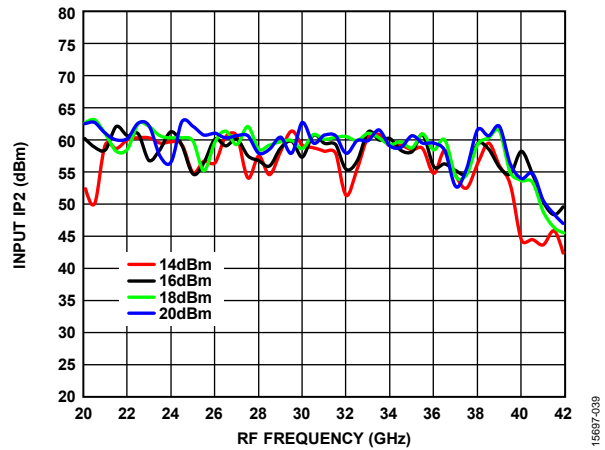

Figure 39. Input IP2 vs. RF Frequency at Various LO Drives, $T_A = 25^\circ\text{C}$

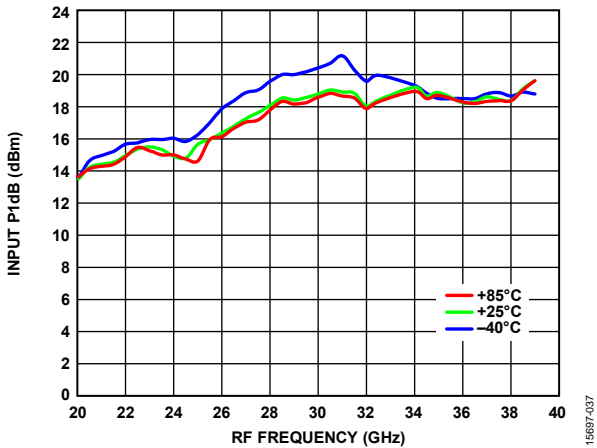

Figure 37. Input P1dB vs. RF Frequency at Various LO Drives, $T_A = 25^\circ\text{C}$

DOWNCONVERTER PERFORMANCE: IF = 2500 MHz, LOWER SIDEBAND (HIGH-SIDE LO)

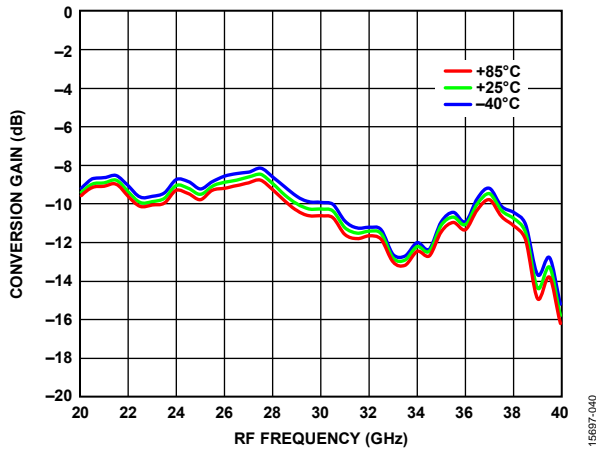

Figure 40. Conversion Gain vs. RF Frequency at Various Temperatures, LO Drive = 18 dBm

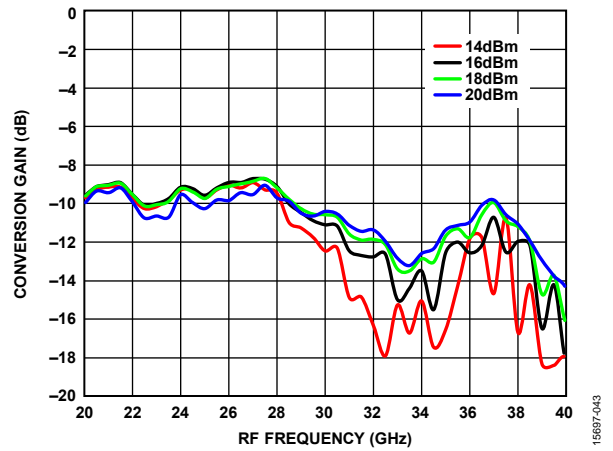

Figure 43. Conversion Gain vs. RF Frequency at Various LO Drives, $T_A = 25^\circ\text{C}$

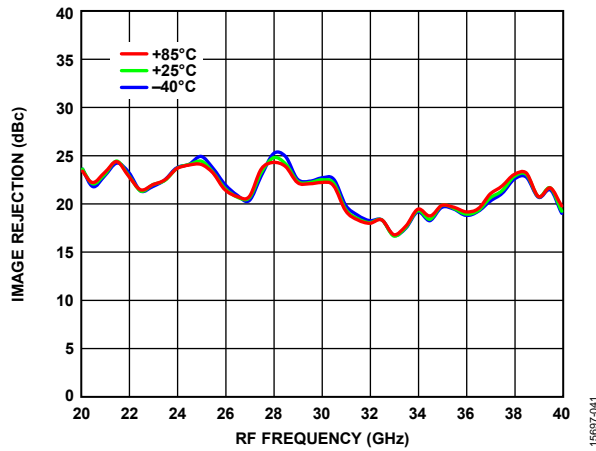

Figure 41. Image Rejection vs. RF Frequency at Various Temperatures, LO Drive = 18 dBm

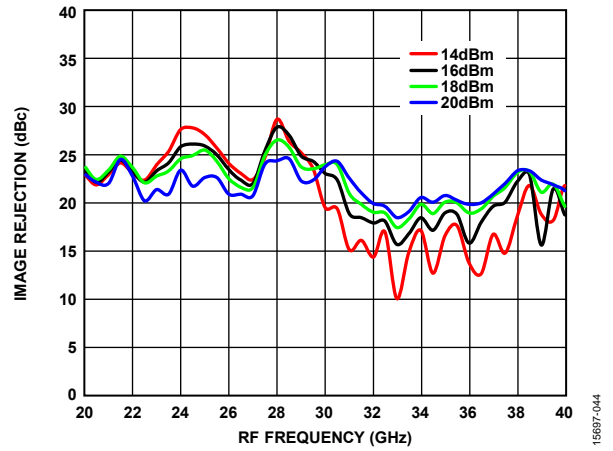

Figure 44. Image Rejection vs. RF Frequency at Various LO Drives, $T_A = 25^\circ\text{C}$

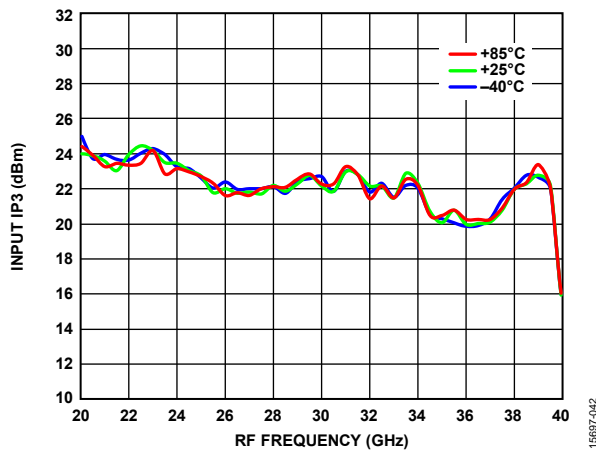

Figure 42. Input IP3 vs. RF Frequency at Various Temperatures, LO Drive = 18 dBm

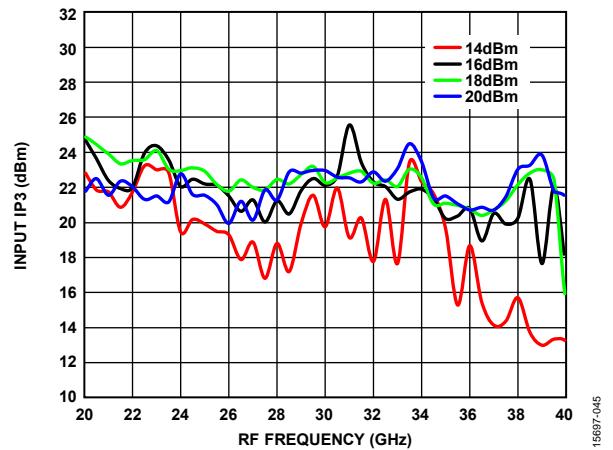

Figure 45. Input IP3 vs. RF Frequency at Various LO Drives, $T_A = 25^\circ\text{C}$

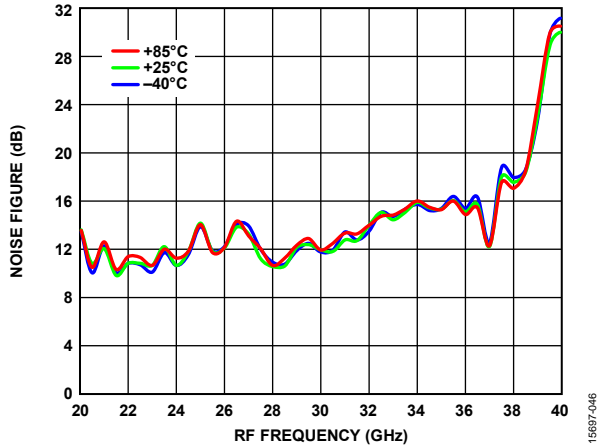

Figure 46. Noise Figure vs. RF Frequency at Various Temperatures, LO Drive = 18 dBm

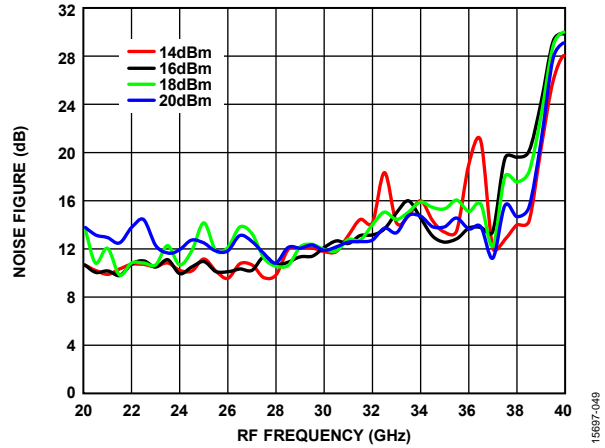

Figure 49. Noise Figure vs. RF Frequency at Various LO Drives, $T_A = 25^\circ\text{C}$

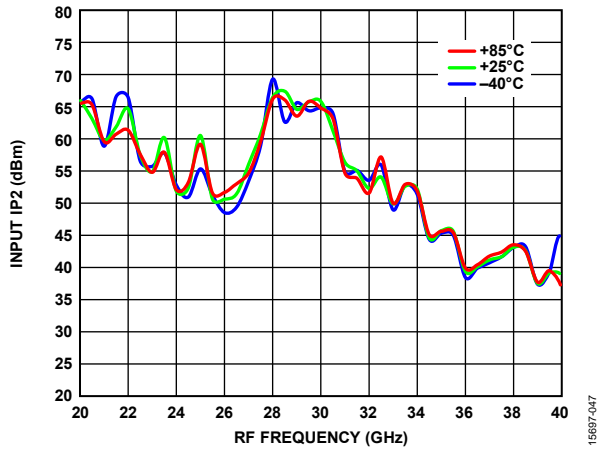

Figure 47. Input IP2 vs. RF Frequency at Various Temperatures, LO Drive = 18 dBm

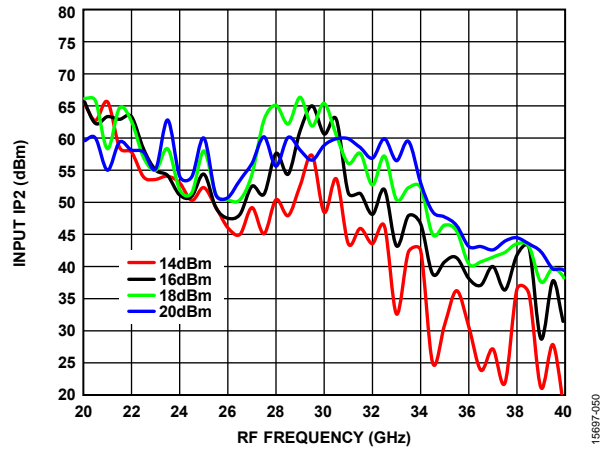

Figure 50. Input IP2 vs. RF Frequency at Various LO Drives, $T_A = 25^\circ\text{C}$

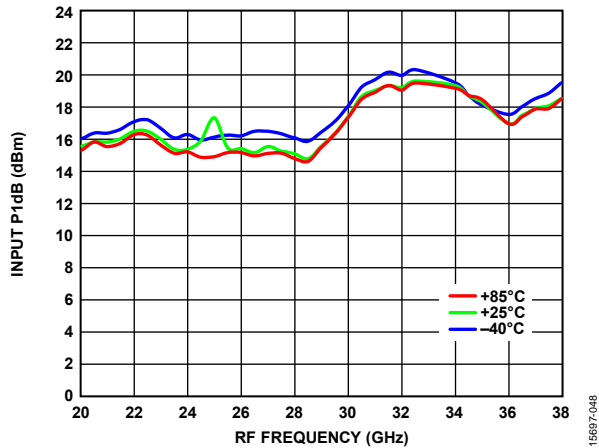

Figure 48. Input P1dB vs. RF Frequency at Various Temperatures, LO Drive = 18 dBm

15687-046

15687-049

15687-047

15687-050

15687-048

DOWNCONVERTER PERFORMANCE: IF = 5000 MHz, LOWER SIDEBAND (HIGH-SIDE LO)

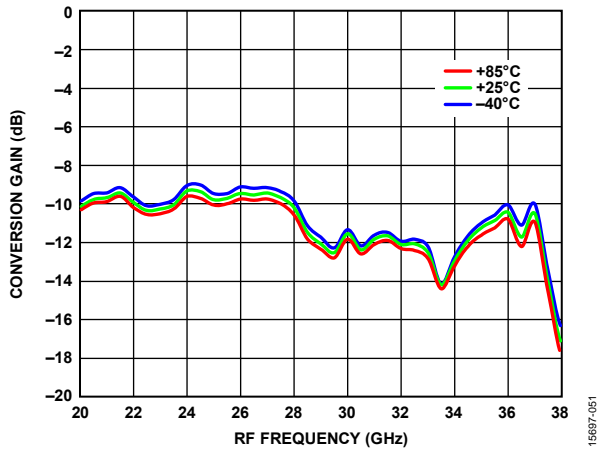

Figure 51. Conversion Gain vs. RF Frequency at Various Temperatures, LO Drive = 18 dBm

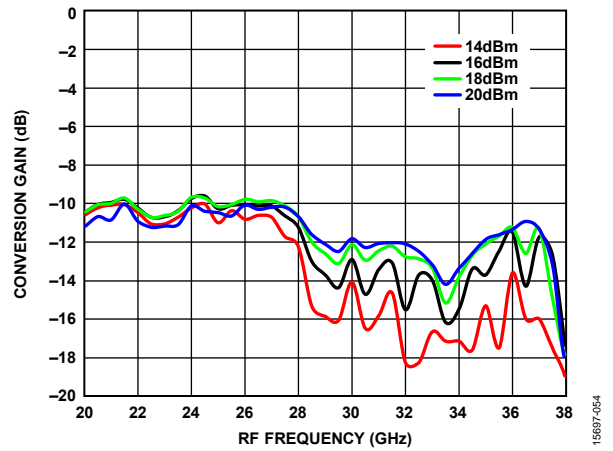

Figure 54. Conversion Gain vs. RF Frequency at Various LO Drives, $T_A = 25^\circ\text{C}$

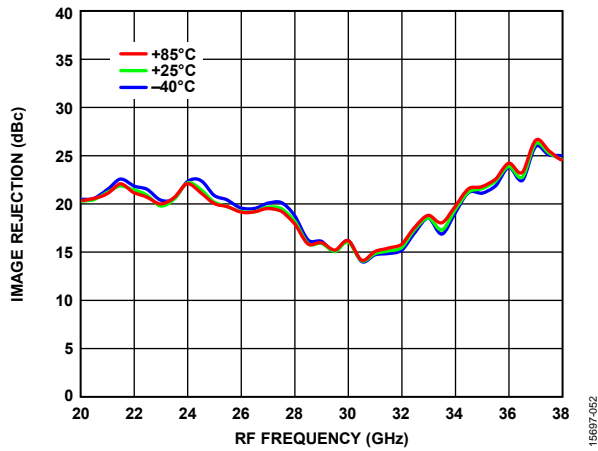

Figure 52. Image Rejection vs. RF Frequency at Various Temperatures, LO Drive = 18 dBm

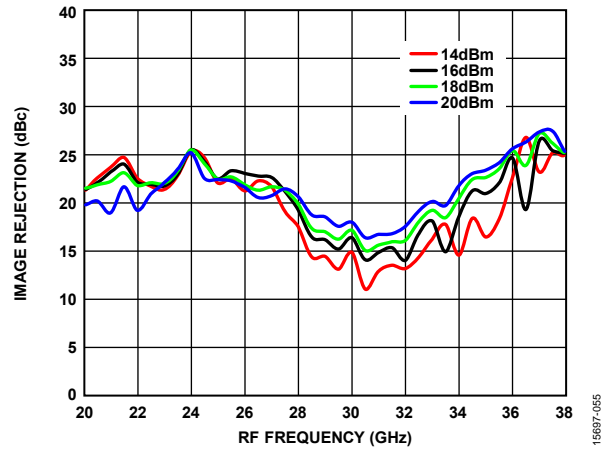

Figure 55. Image Rejection vs. RF Frequency at Various LO Drives, $T_A = 25^\circ\text{C}$

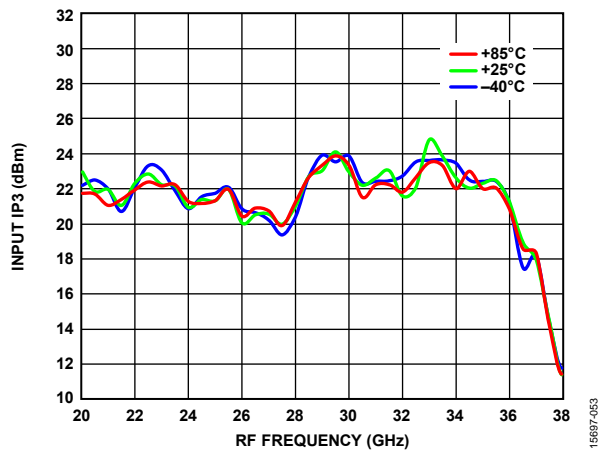

Figure 53. Input IP3 vs. RF Frequency at Various Temperatures, LO Drive = 18 dBm

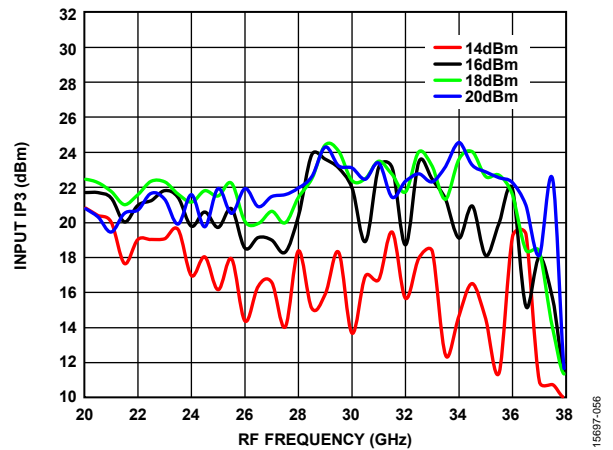

Figure 56. Input IP3 vs. RF Frequency at Various LO Drives, $T_A = 25^\circ\text{C}$

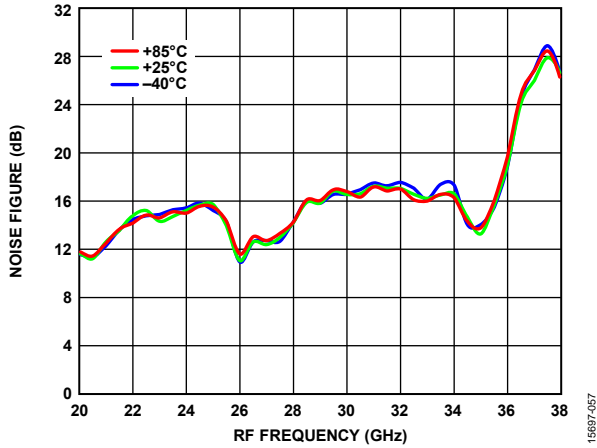

Figure 57. Noise Figure vs. RF Frequency at Various Temperatures, LO Drive = 18 dBm

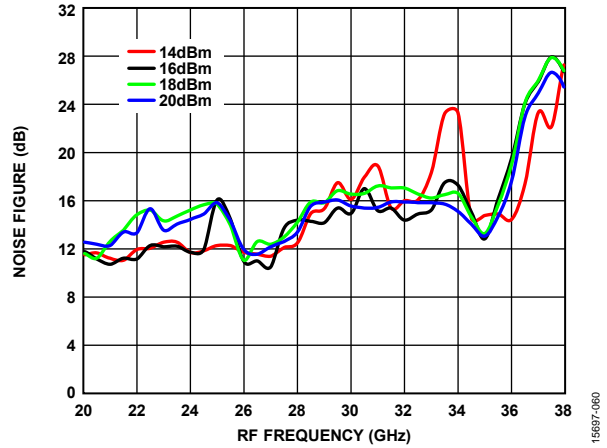

Figure 60. Noise Figure vs. RF Frequency at Various LO Drives, $T_A = 25^\circ\text{C}$

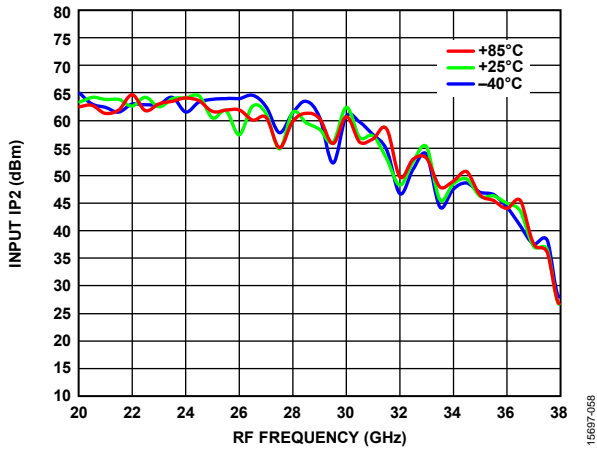

Figure 58. Input IP2 vs. RF Frequency at Various Temperatures, LO Drive = 18 dBm

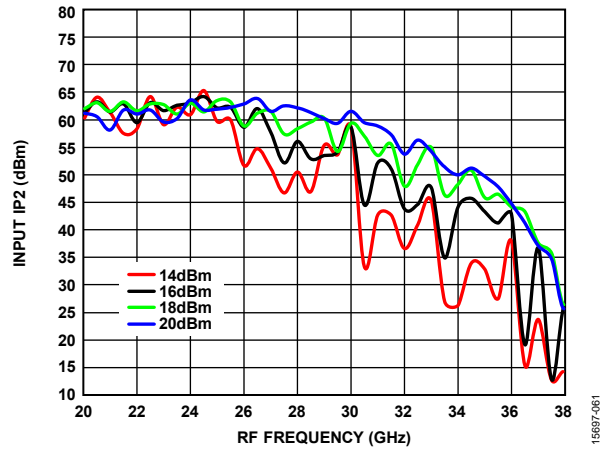

Figure 61. Input IP2 vs. RF Frequency at Various LO Drives, $T_A = 25^\circ\text{C}$

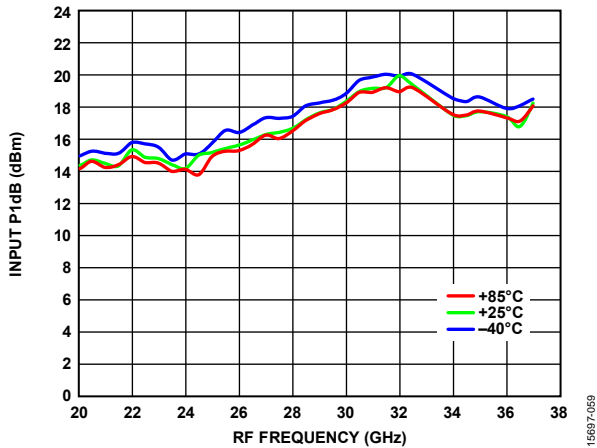

Figure 59. Input P1dB vs. RF Frequency at Various Temperatures, LO Drive = 18 dBm

15687-057

15687-060

15687-058

15687-061

15687-059

UPCONVERTER PERFORMANCE: IF = 100 MHz, UPPER SIDEBAND

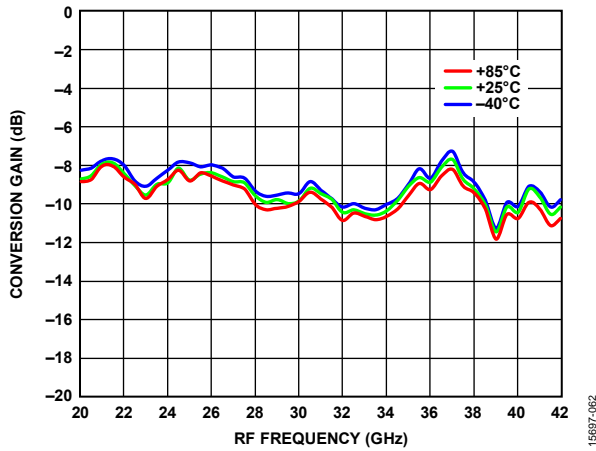

Figure 62. Conversion Gain vs. RF Frequency at Various Temperatures, LO Drive = 18 dBm

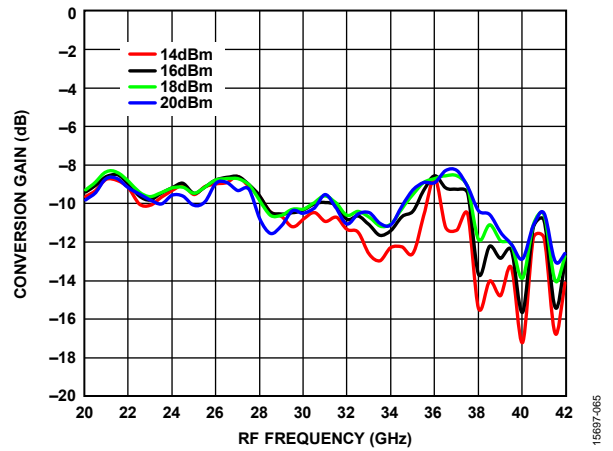

Figure 65. Conversion Gain vs. RF Frequency at Various LO Drives, $T_A = 25^\circ\text{C}$

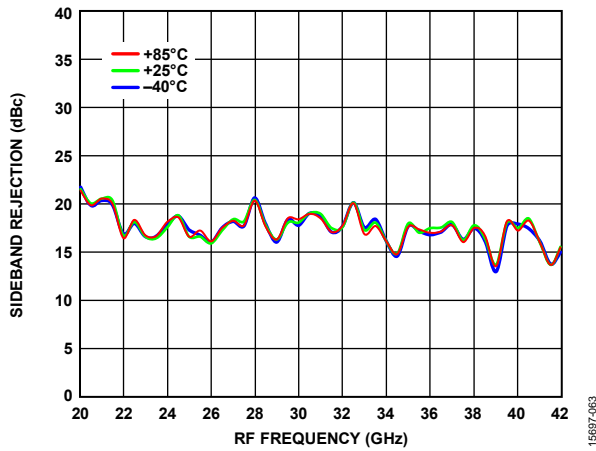

Figure 63. Sideband Rejection vs. RF Frequency at Various Temperatures, LO Drive = 18 dBm

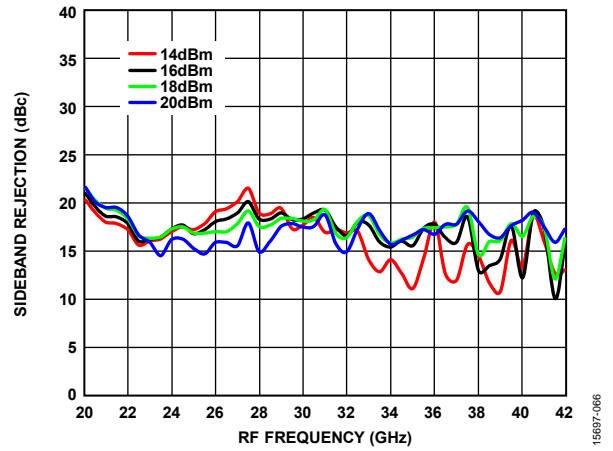

Figure 66. Sideband Rejection vs. RF Frequency at Various LO Drives, $T_A = 25^\circ\text{C}$

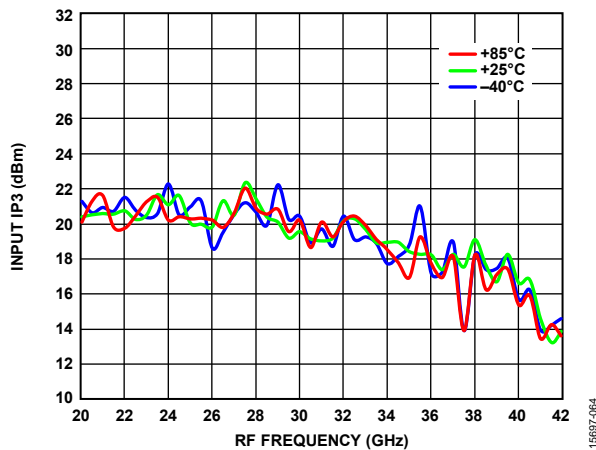

Figure 64. Input IP3 vs. RF Frequency at Various Temperatures, LO Drive = 18 dBm

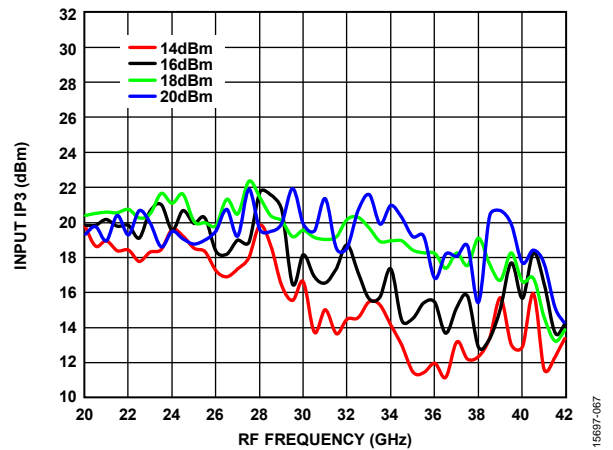

Figure 67. Input IP3 vs. RF Frequency at Various LO Drives, $T_A = 25^\circ\text{C}$

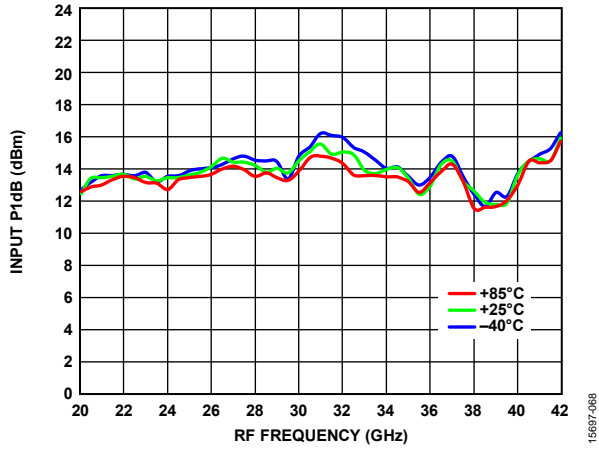

Figure 68. Input P1dB vs. RF Frequency at Various Temperatures, LO Drive = 18 dBm

UPCONVERTER PERFORMANCE: IF = 2500 MHz, UPPER SIDEBAND

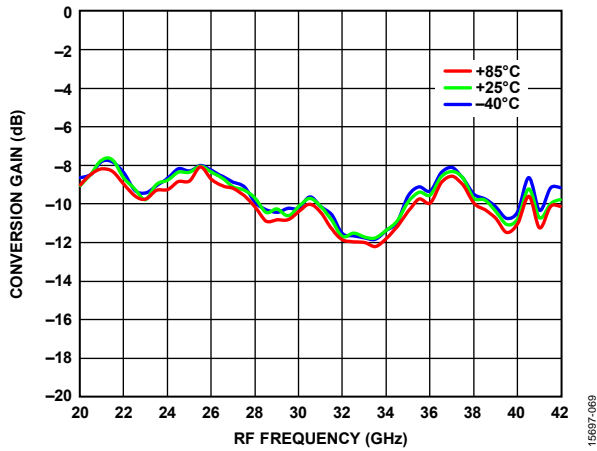

Figure 69. Conversion Gain vs. RF Frequency at Various Temperatures, LO Drive = 18 dBm

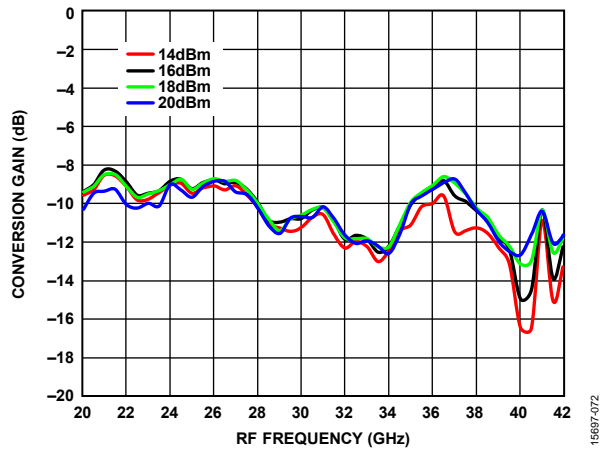

Figure 72. Conversion Gain vs. RF Frequency at Various LO Drives, $T_A = 25^\circ\text{C}$

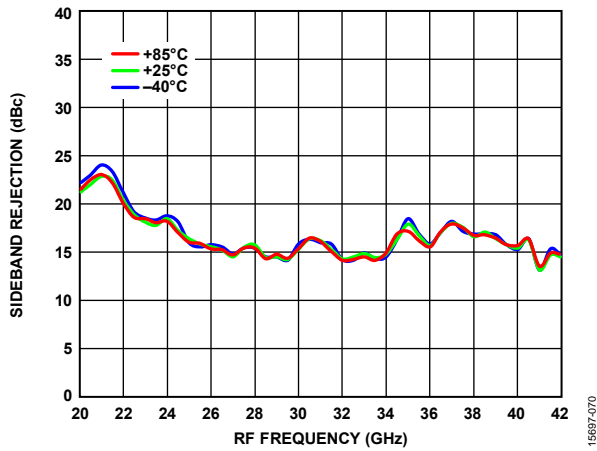

Figure 70. Sideband Rejection vs. RF Frequency at Various Temperatures, LO Drive = 18 dBm

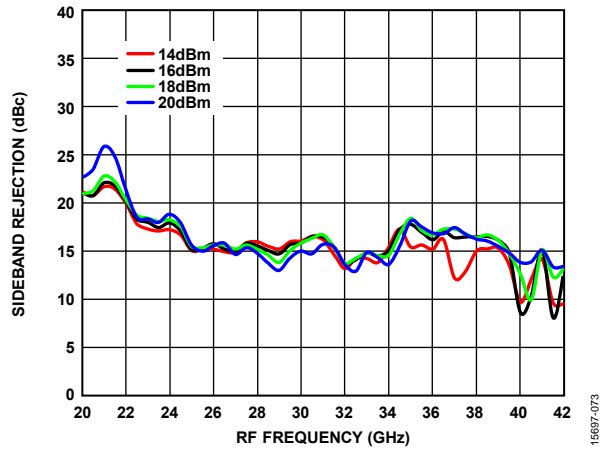

Figure 73. Sideband Rejection vs. RF Frequency at Various LO Drives, $T_A = 25^\circ\text{C}$

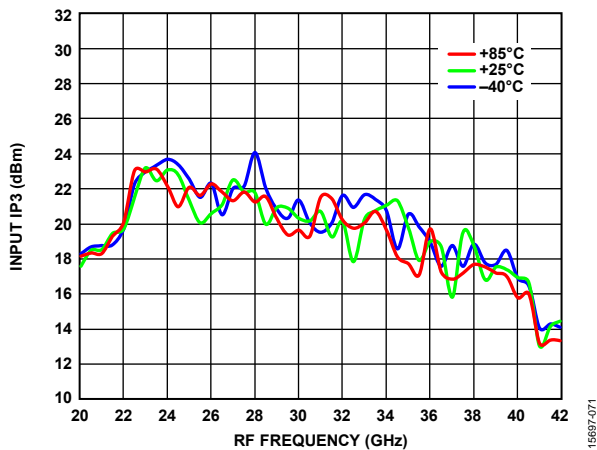

Figure 71. Input IP3 vs. RF Frequency at Various Temperatures, LO Drive = 18 dBm

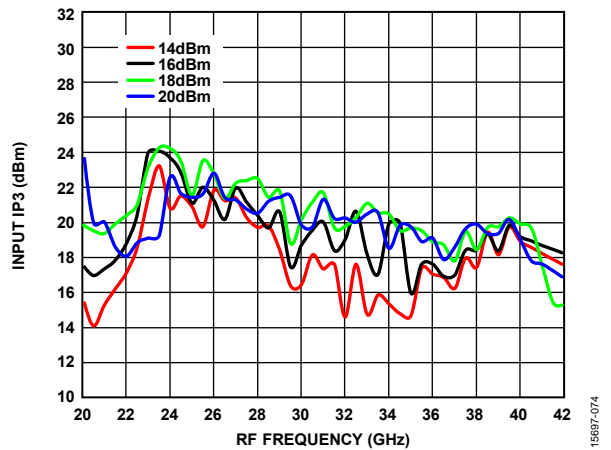

Figure 74. Input IP3 vs. RF Frequency at Various LO Drives, $T_A = 25^\circ\text{C}$

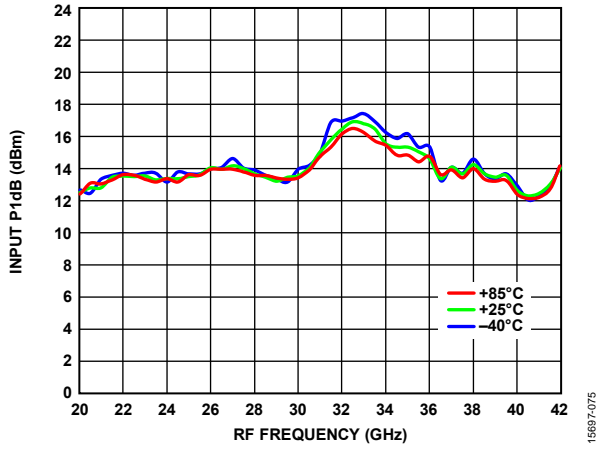

Figure 75. Input P1dB vs. RF Frequency at Various Temperatures, LO Drive = 18 dBm

19687-075

UPCONVERTER PERFORMANCE: IF = 5000 MHz, UPPER SIDEBAND

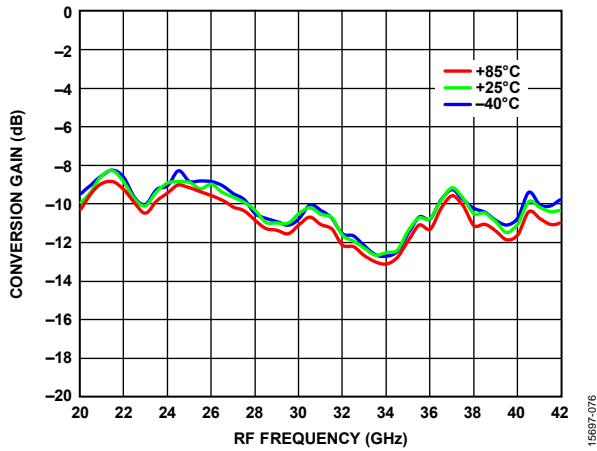

Figure 76. Conversion Gain vs. RF Frequency at Various Temperatures, LO Drive = 18 dBm

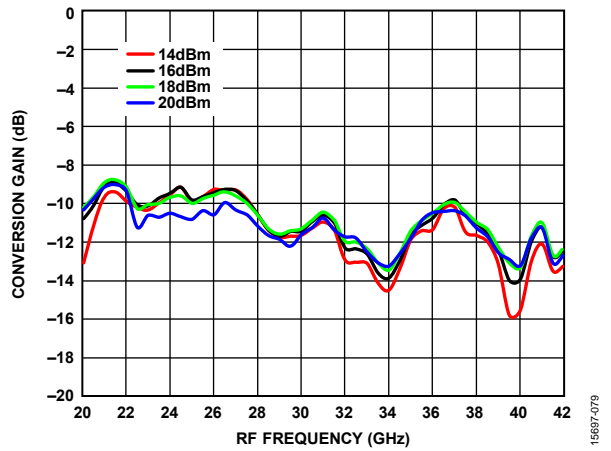

Figure 79. Conversion Gain vs. RF Frequency at Various LO Drives, TA = 25°C

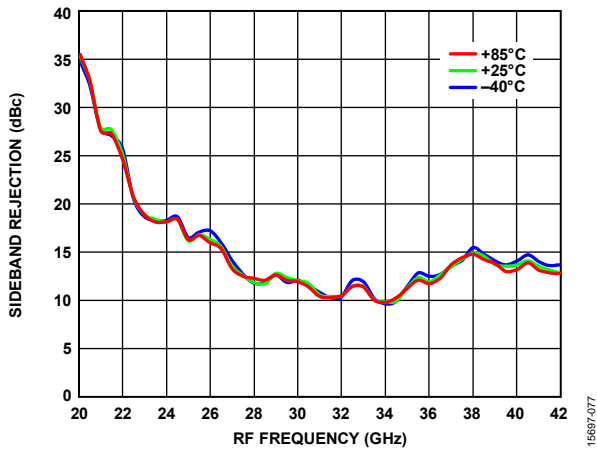

Figure 77. Sideband Rejection vs. RF Frequency at Various Temperatures, LO Drive = 18 dBm

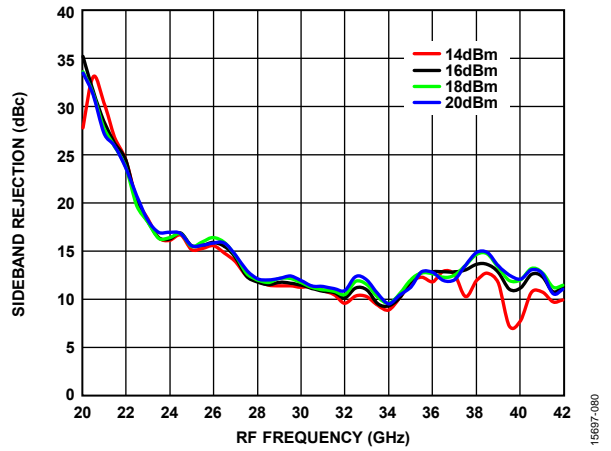

Figure 80. Sideband Rejection vs. RF Frequency at Various LO Drives, TA = 25°C

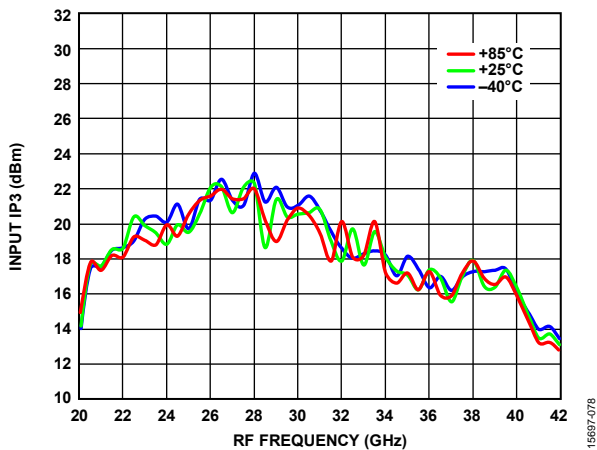

Figure 78. Input IP3 vs. RF Frequency at Various Temperatures, LO Drive = 18 dBm

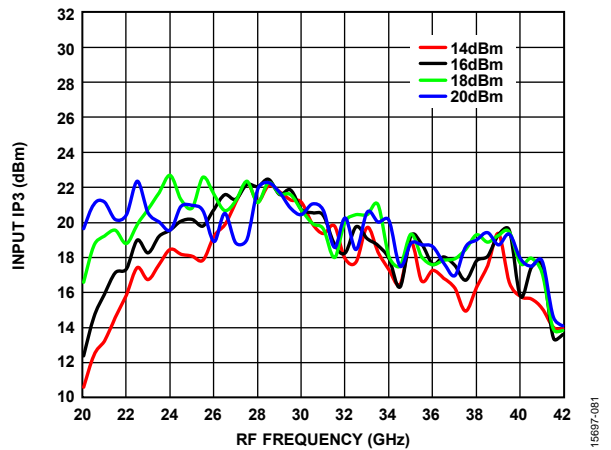

Figure 81. Input IP3 vs. RF Frequency at Various LO Drives, TA = 25°C

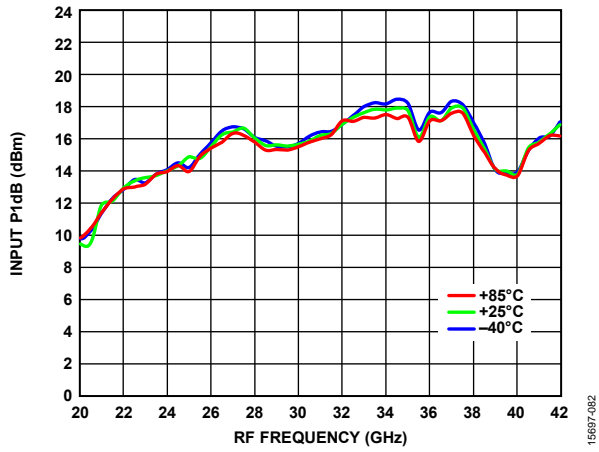

Figure 82. Input P1dB vs. RF Frequency at Various Temperatures, LO Drive = 18 dBm

19687-082

UPCONVERTER PERFORMANCE: IF = 2500 MHz, LOWER SIDEBAND

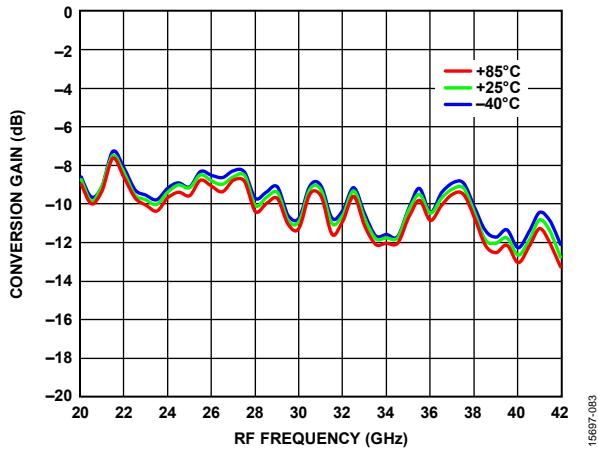

Figure 83. Conversion Gain vs. RF Frequency at Various Temperatures, LO Drive = 18 dBm

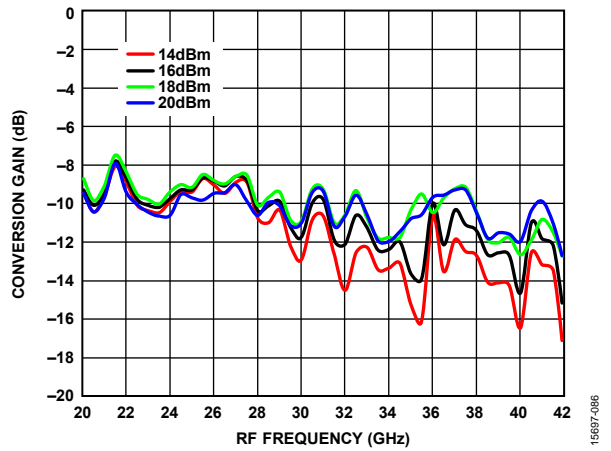

Figure 86. Conversion Gain vs. RF Frequency at Various LO Drives, $T_A = 25^\circ\text{C}$

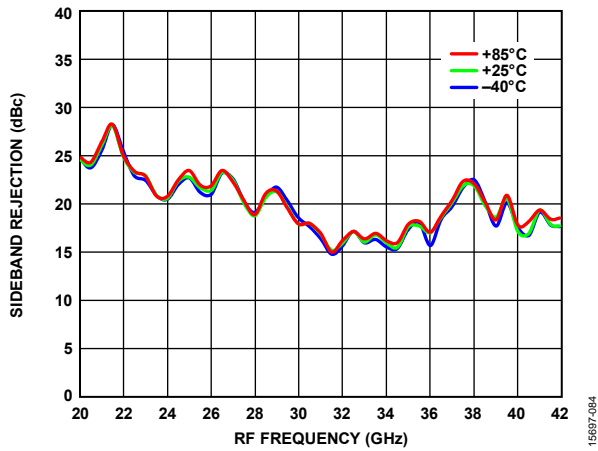

Figure 84. Sideband Rejection vs. RF Frequency at Various Temperatures, LO Drive = 18 dBm

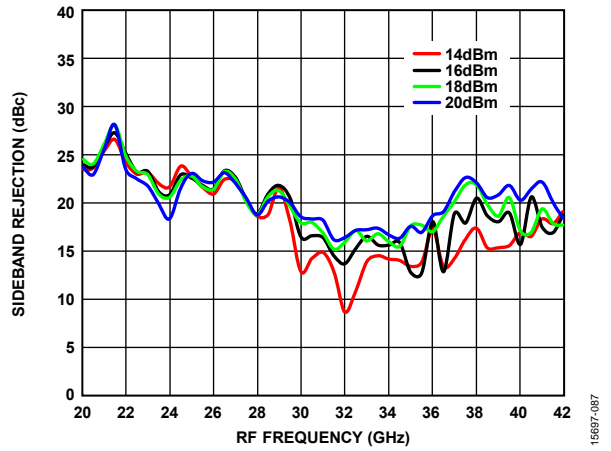

Figure 87. Sideband Rejection vs. RF Frequency at Various LO Drives, $T_A = 25^\circ\text{C}$

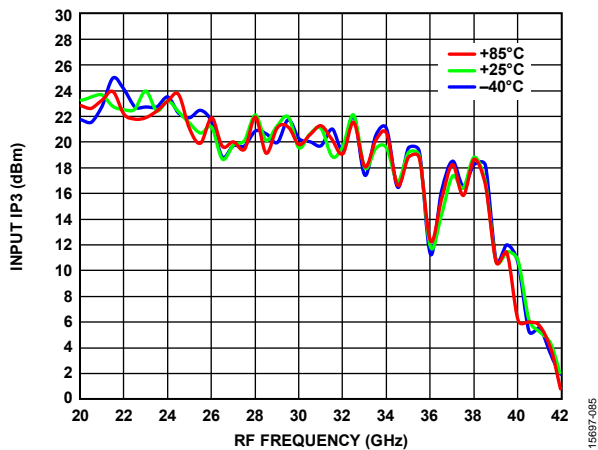

Figure 85. Input IP3 vs. RF Frequency at Various Temperatures, LO Drive = 18 dBm

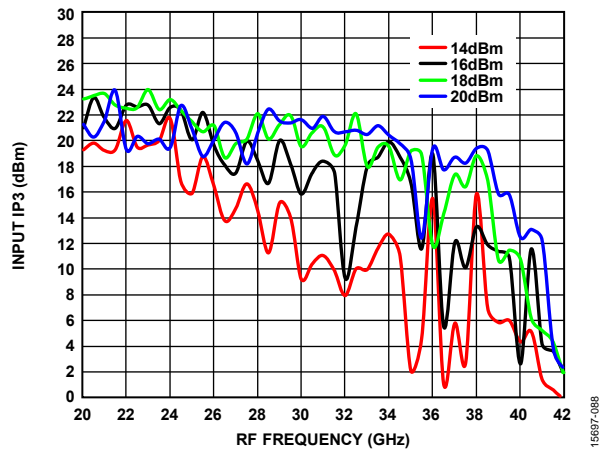

Figure 88. Input IP3 vs. RF Frequency at Various LO Drives, $T_A = 25^\circ\text{C}$

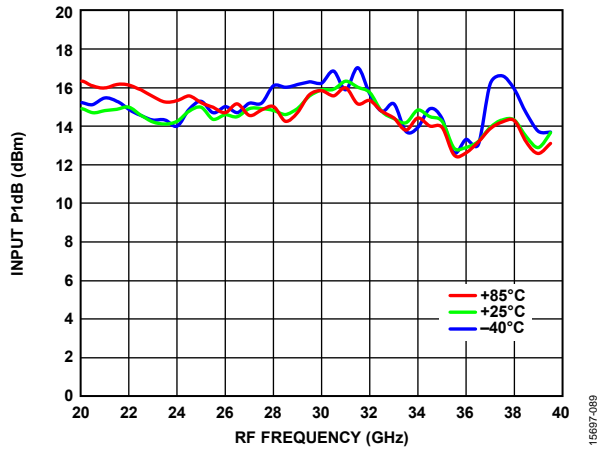

Figure 89. Input P1dB vs. RF Frequency at Various Temperatures, LO Drive = 18 dBm

15667-089

UPCONVERTER PERFORMANCE: IF = 5000 MHz, LOWER SIDEBAND

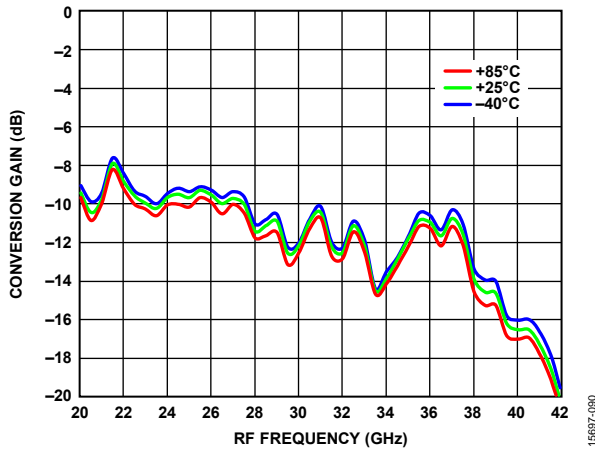

Figure 90. Conversion Gain vs. RF Frequency at Various Temperatures, LO Drive = 18 dBm

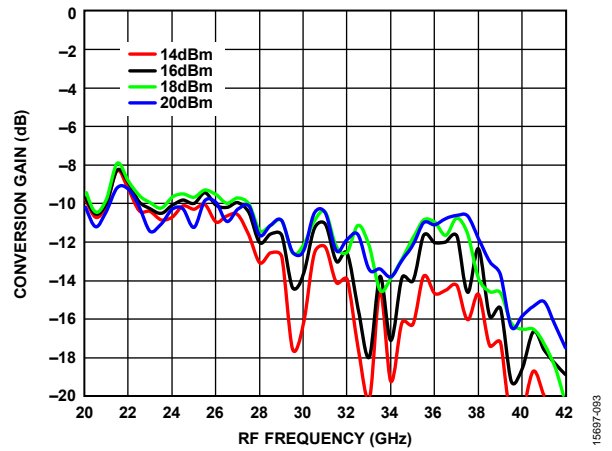

Figure 93. Conversion Gain vs. RF Frequency at Various LO Drives, $T_A = 25^\circ\text{C}$

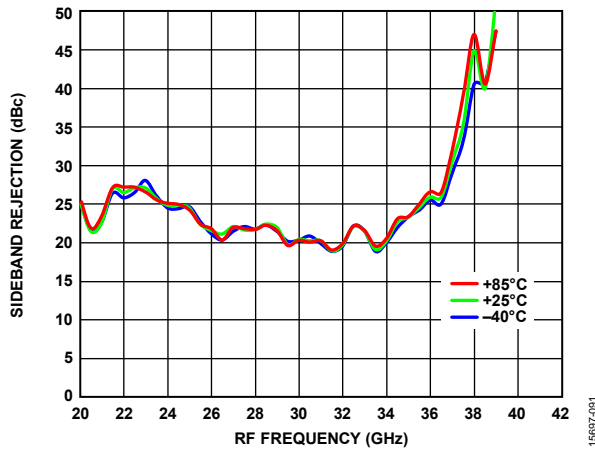

Figure 91. Sideband Rejection vs. RF Frequency at Various Temperatures, LO Drive = 18 dBm

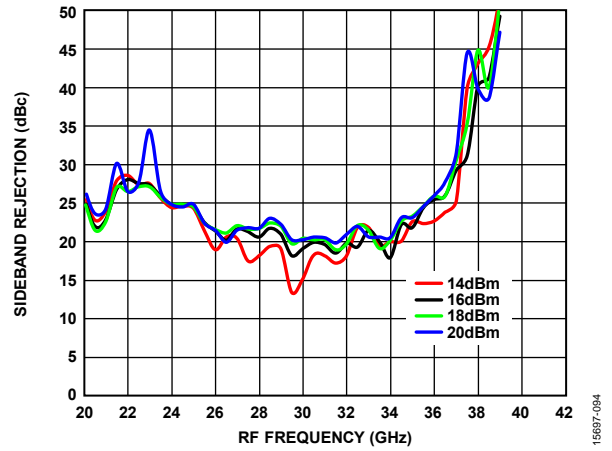

Figure 94. Sideband Rejection vs. RF Frequency at Various LO Drives, $T_A = 25^\circ\text{C}$

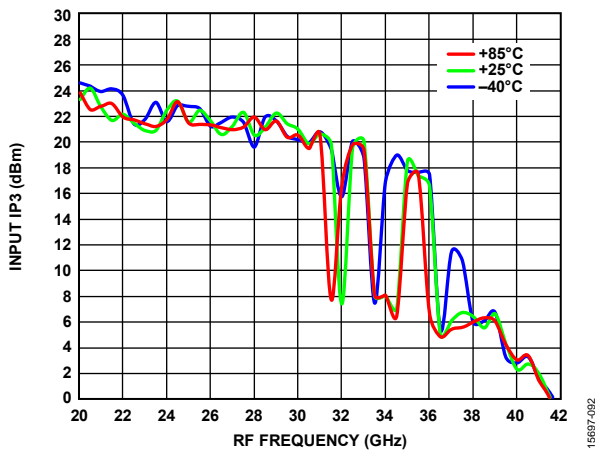

Figure 92. Input IP3 vs. RF Frequency at Various Temperatures, LO Drive = 18 dBm

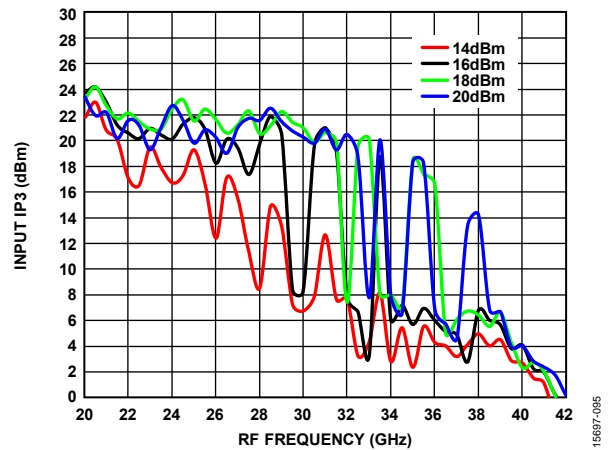

Figure 95. Input IP3 vs. RF Frequency at Various LO Drives, $T_A = 25^\circ\text{C}$

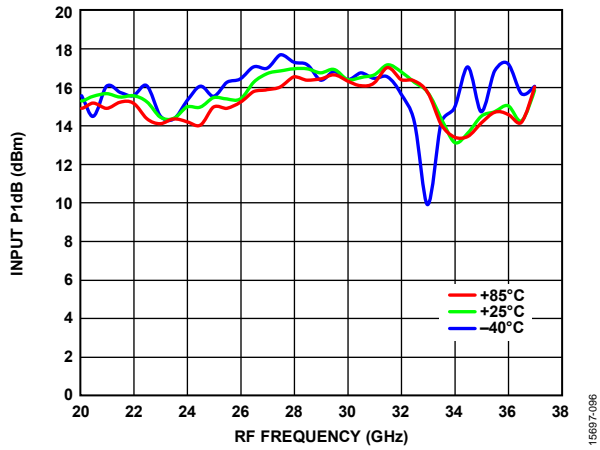

Figure 96. Input P1dB vs. RF Frequency at Various Temperatures, LO Drive = 18 dBm

ISOLATION AND RETURN LOSS WITHOUT EXTERNAL 90° HYBRID AT THE IF_x PORTS

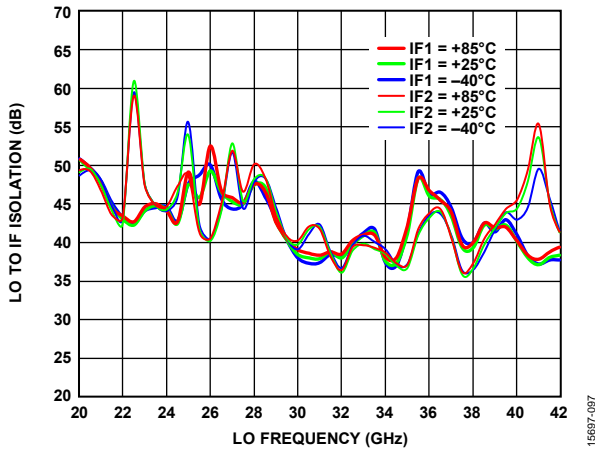

Figure 97. LO to IF Isolation vs. LO Frequency at Various Temperatures, IF = 100 MHz, LO Drive = 18 dBm

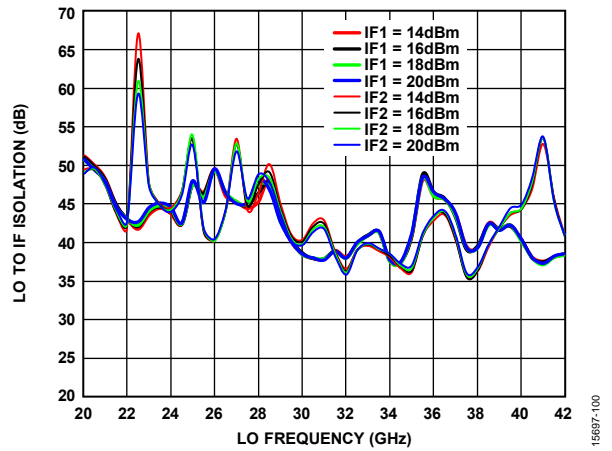

Figure 100. LO to IF Isolation vs. LO Frequency at Various LO Drives, IF = 100 MHz, T_A = 25°C

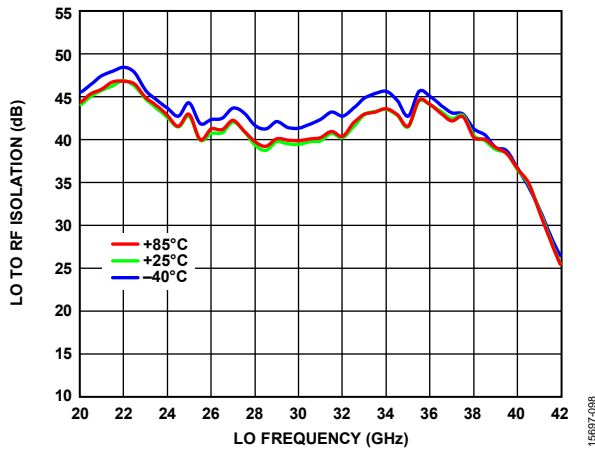

Figure 98. LO to RF Isolation vs. LO Frequency at Various Temperatures, IF = 100 MHz, LO Drive = 18 dBm

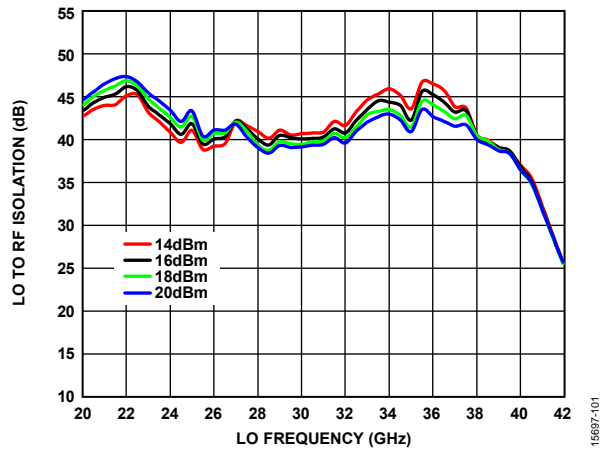

Figure 101. LO to RF Isolation vs. LO Frequency at Various LO Drives, IF = 100 MHz, T_A = 25°C

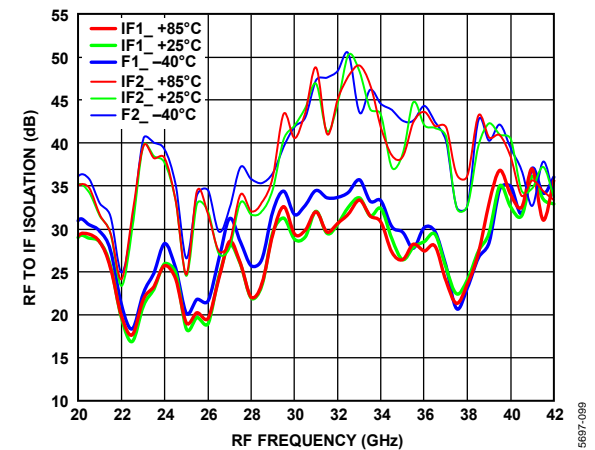

Figure 99. RF to IF Isolation vs. RF Frequency at Various Temperatures, LO Drive = 18 dBm

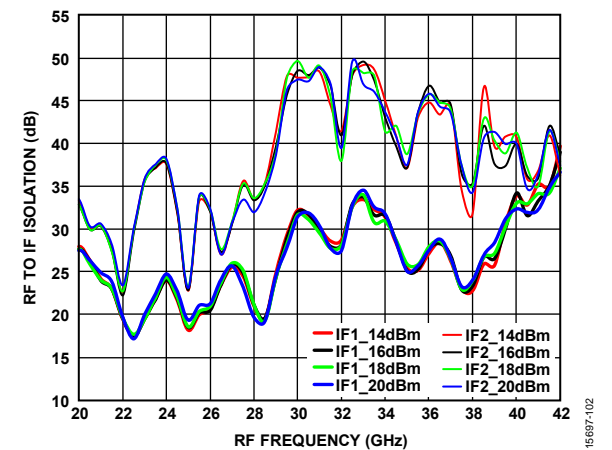

Figure 102. RF to IF Isolation vs. RF Frequency at Various LO Drives, T_A = 25°C

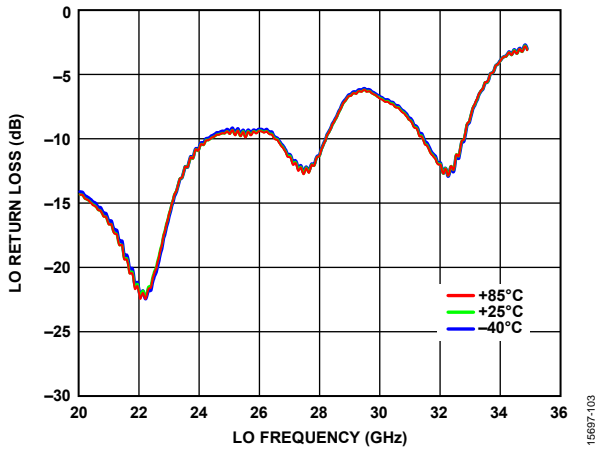

Figure 103. LO Return Loss vs. LO Frequency at Various Temperatures, LO Drive = 18 dBm

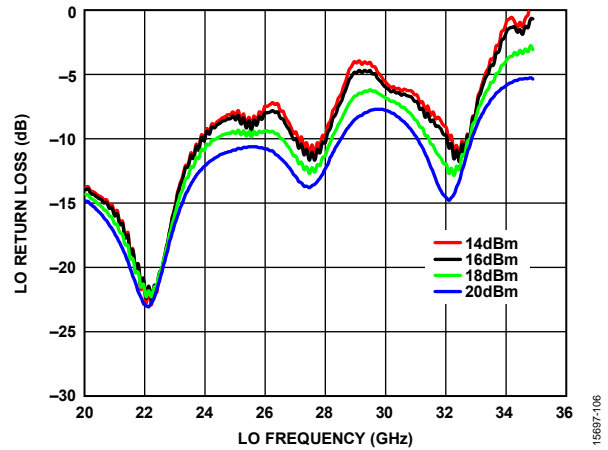

Figure 106. LO Return Loss vs. LO Frequency at Various LO Drives

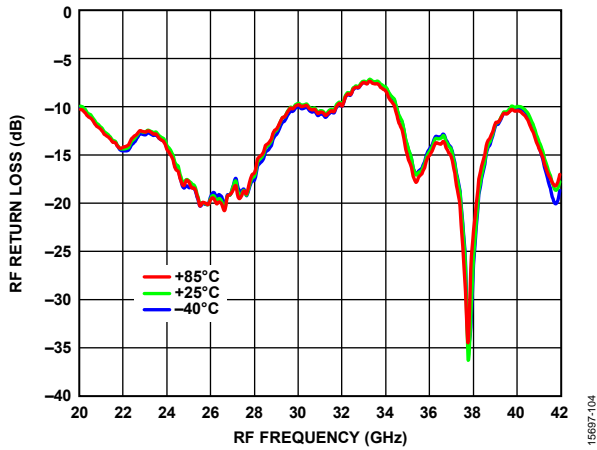

Figure 104. RF Return Loss vs. RF Frequency at Various Temperatures, LO Frequency = 32 GHz, LO Drive = 18 dBm

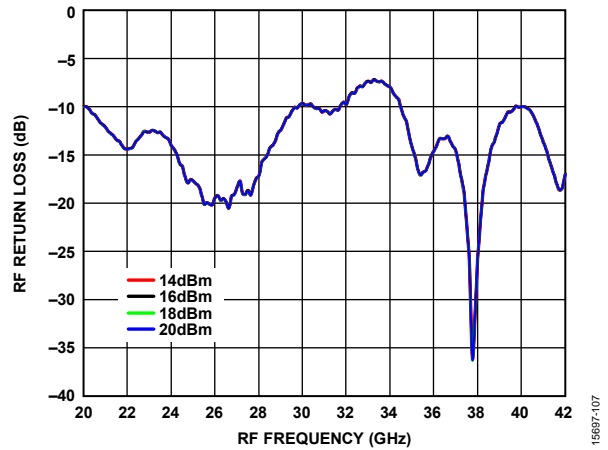

Figure 107. RF Return Loss vs. RF Frequency at Various LO Drives, LO Frequency = 32 GHz

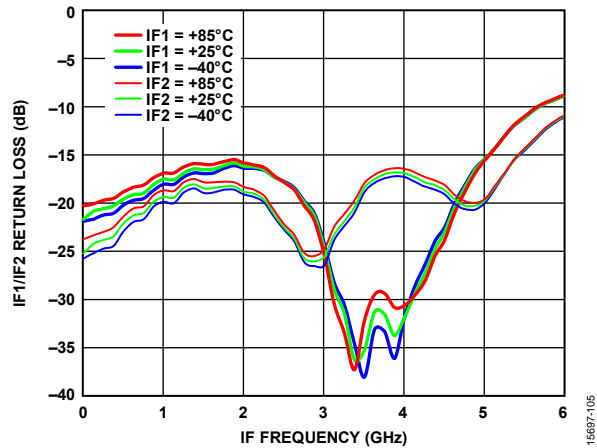

Figure 105. IF1/IF2 Return Loss vs. IF Frequency at Various Temperatures, LO Frequency = 32 GHz, LO Drive = 18 dBm

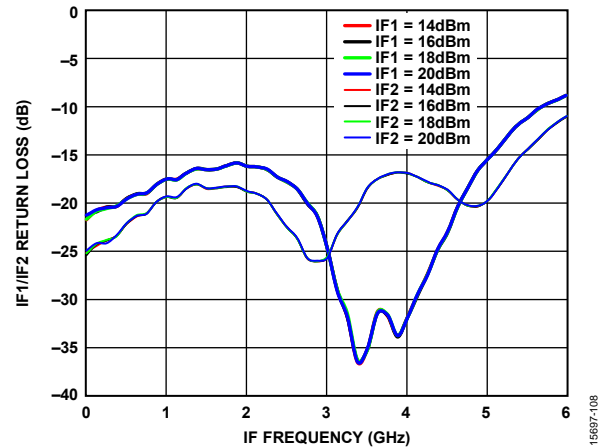

Figure 108. IF1/IF2 Return Loss vs. IF Frequency at Various LO Drives, LO Frequency = 32 GHz

IF BANDWIDTH PERFORMANCE: DOWNCONVERTER, UPPER SIDEBAND (LOW-SIDE LO)

Data over the IF frequency was taken without an external 90° hybrid at the IFx ports.

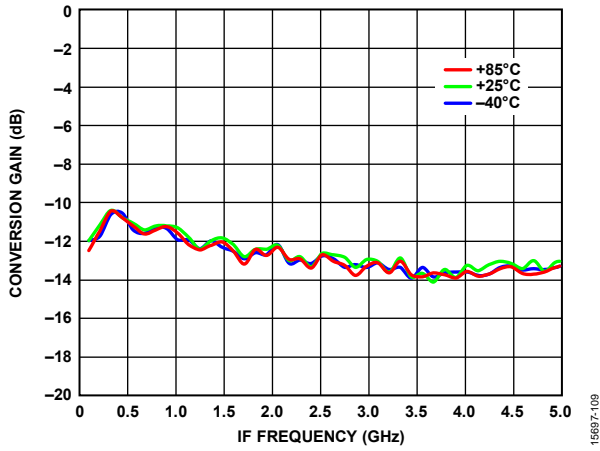

Figure 109. Conversion Gain vs. IF Frequency at Various Temperatures, LO Drive = 18 dBm at 32 GHz

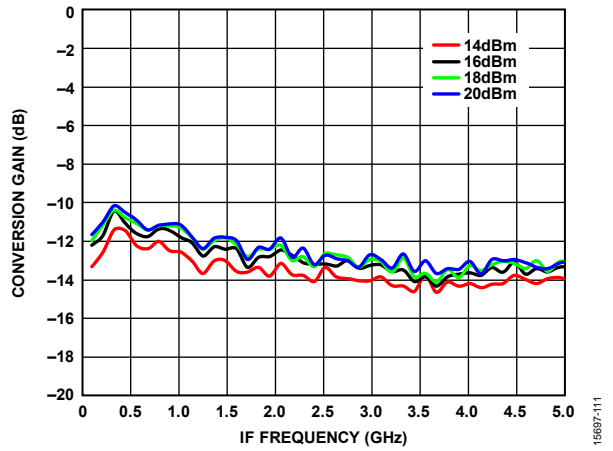

Figure 111. Conversion Gain vs. IF Frequency at Various LO Drives, LO Frequency = 32 GHz, T_A = 25°C

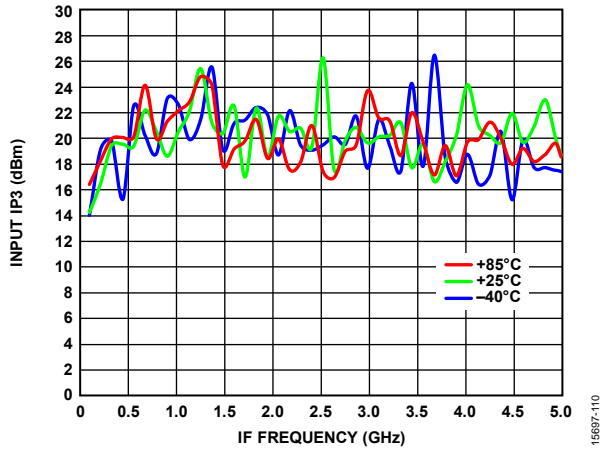

Figure 110. Input IP3 vs. IF Frequency at Various Temperatures, LO Drive = 18 dBm at 32 GHz

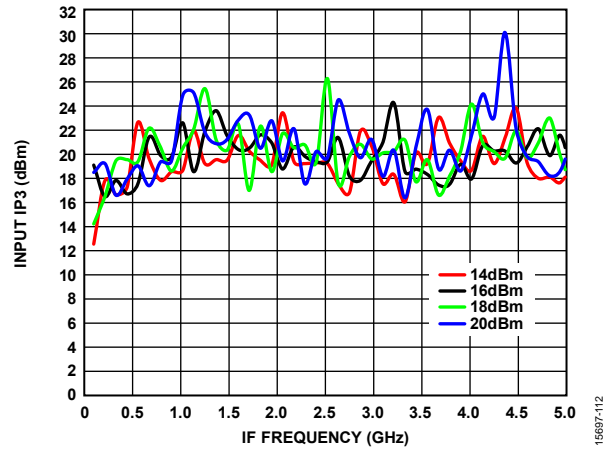

Figure 112. Input IP3 vs. IF Frequency at Various LO Drives, LO Frequency = 32 GHz, T_A = 25°C

IF BANDWIDTH PERFORMANCE: DOWNCONVERTER, LOWER SIDEBAND (HIGH-SIDE LO)

Data over the IF frequency was taken without an external 90° hybrid at the IFx ports.

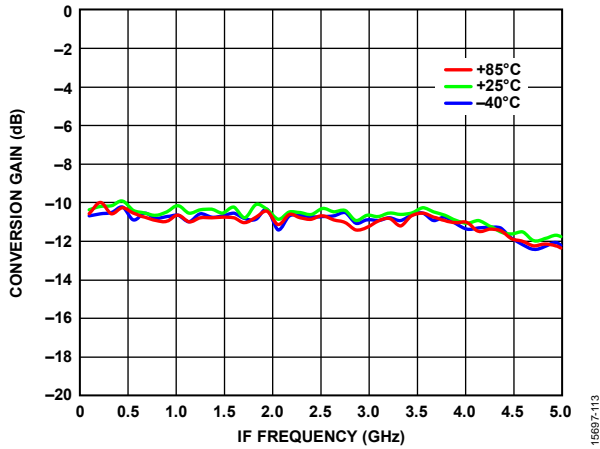

Figure 113. Conversion Gain vs. IF Frequency at Various Temperatures, LO Drive = 18 dBm at 32 GHz

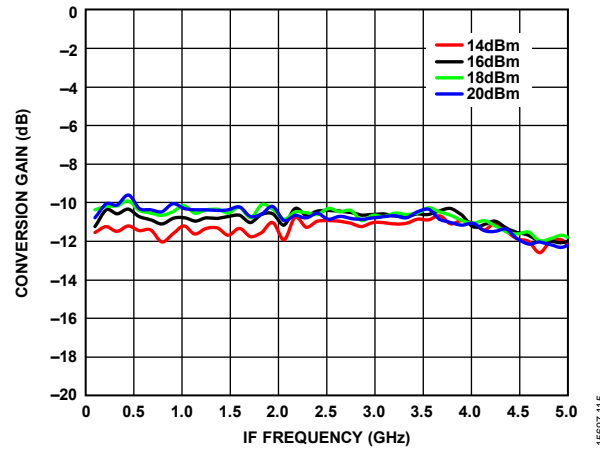

Figure 115. Conversion Gain vs. IF Frequency at Various LO Drives, LO Frequency = 32 GHz, T_A = 25°C

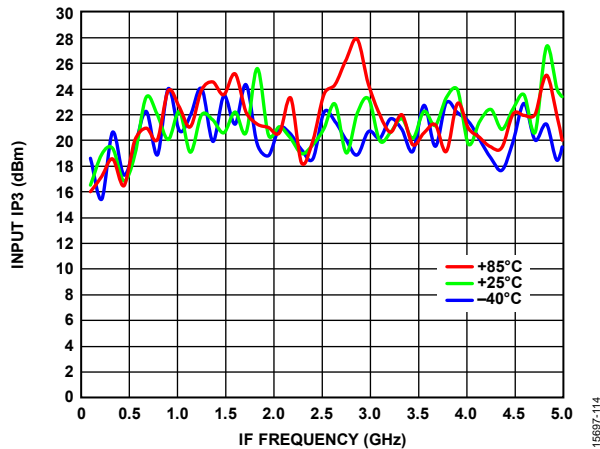

Figure 114. Input IP3 vs. IF Frequency at Various Temperatures, LO Drive = 18 dBm at 32 GHz

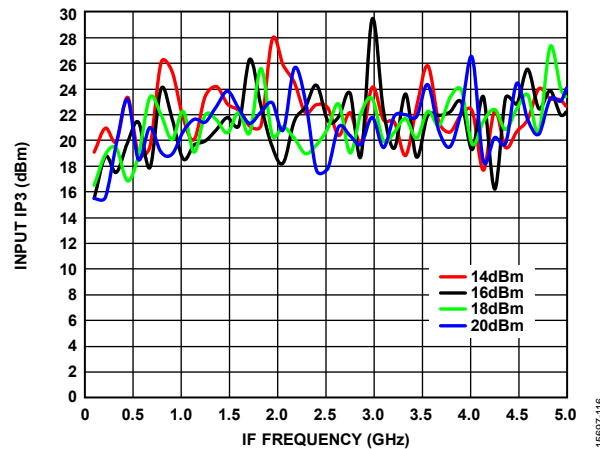

Figure 116. Input IP3 vs. IF Frequency at Various LO Drives, LO Frequency = 32 GHz, T_A = 25°C

AMPLITUDE AND PHASE IMBALANCE PERFORMANCE: DOWNCONVERTER, UPPER SIDEBAND (LOW-SIDE LO)

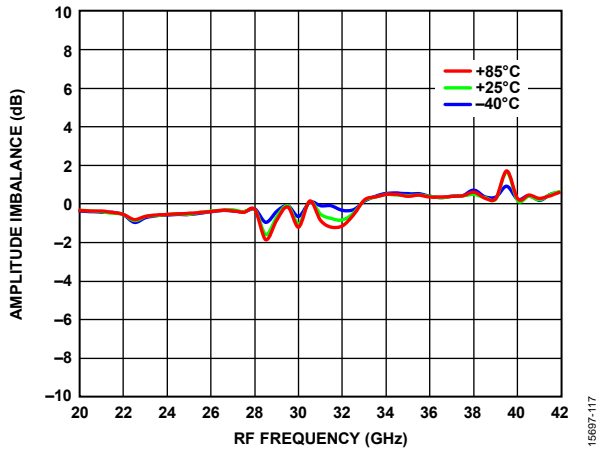

Figure 117. Amplitude Imbalance vs. RF Frequency at Various Temperatures, LO Drive = 18 dBm, IF = 100 MHz

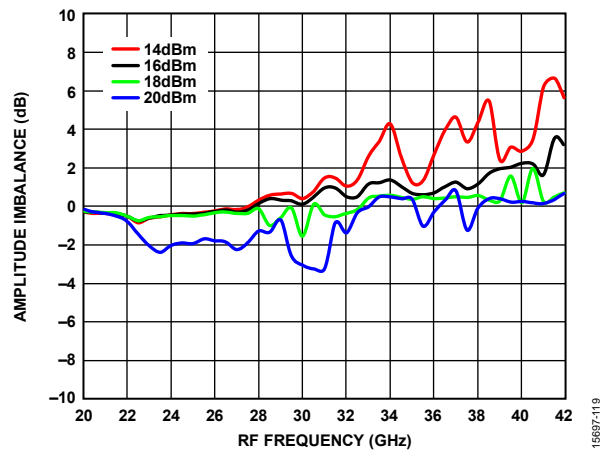

Figure 119. Amplitude Imbalance vs. RF Frequency at Various LO Drives, IF = 100 MHz, T_A = 25°C

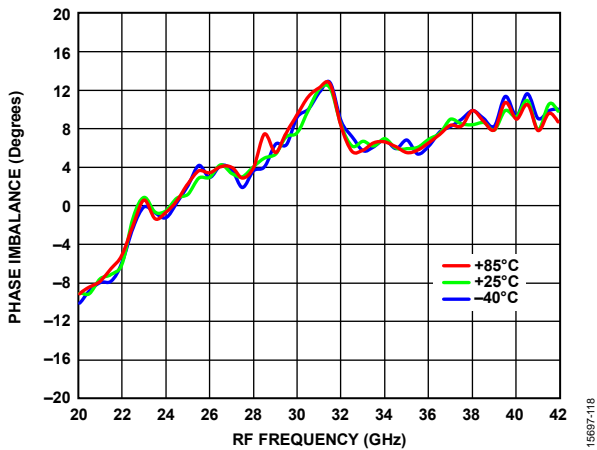

Figure 118. Phase Imbalance vs. RF Frequency at Various Temperatures, LO Drive = 18 dBm, IF = 100 MHz

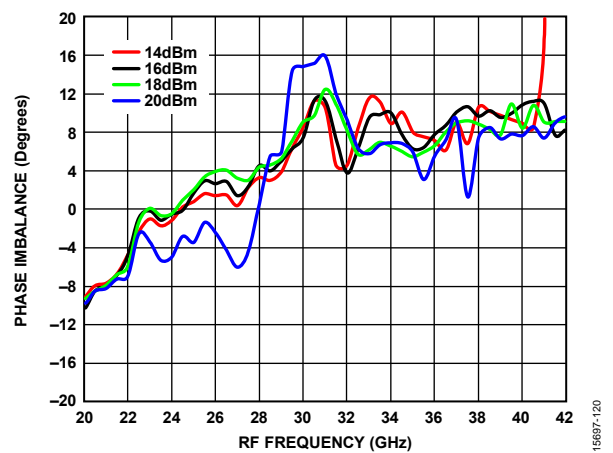

Figure 120. Phase Imbalance vs. RF Frequency at Various LO Drives, IF = 100 MHz, T_A = 25°C

SPURIOUS AND HARMONICS PERFORMANCE

Data was taken without an IF hybrid at the IFx ports. N/A means not applicable.

Downconverter $M \times N$ Spurious Outputs

Mixer spurious products are measured in dBc from the IF output power level, unless otherwise specified. Spur values are $(M \times RF) - (N \times LO)$.

IF = 100 MHz, RF = 20,000 MHz, LO = 19,900 MHz, RF power = -10 dBm, LO power = 18 dBm, and $T_A = 25^\circ\text{C}$.

| | | N x LO | | | | | |
|--------|---|--------|-----|-----|-----|-----|-----|
| | | 0 | 1 | 2 | 3 | 4 | 5 |
| M x RF | 0 | N/A | 10 | 37 | N/A | N/A | N/A |
| | 1 | 14 | 0 | 45 | 62 | N/A | N/A |
| | 2 | 66 | 76 | 66 | 74 | 66 | N/A |
| | 3 | N/A | 66 | 75 | 67 | 74 | 66 |
| | 4 | N/A | N/A | 66 | 74 | 88 | 76 |
| | 5 | N/A | N/A | N/A | 63 | 75 | 88 |

IF = 100 MHz, RF = 30,000 MHz, LO = 29,900 MHz, RF power = -10 dBm, LO power = 18 dBm, and $T_A = 25^\circ\text{C}$.

| | | N x LO | | | | | |
|--------|---|--------|-----|-----|-----|-----|-----|
| | | 0 | 1 | 2 | 3 | 4 | 5 |
| M x RF | 0 | N/A | 1 | N/A | N/A | N/A | N/A |
| | 1 | 19 | 0 | 49 | N/A | N/A | N/A |
| | 2 | N/A | 72 | 79 | 71 | N/A | N/A |
| | 3 | N/A | N/A | 70 | 83 | 72 | N/A |
| | 4 | N/A | N/A | N/A | 70 | 88 | 73 |
| | 5 | N/A | N/A | N/A | N/A | 69 | 89 |

IF = 100 MHz, RF = 40,000 MHz, LO = 39,900 MHz, RF power = -10 dBm, LO power = 18 dBm, and $T_A = 25^\circ\text{C}$.

| | | N x LO | | | | | |
|--------|---|--------|-----|-----|-----|-----|-----|
| | | 0 | 1 | 2 | 3 | 4 | 5 |
| M x RF | 0 | N/A | -4 | N/A | N/A | N/A | N/A |
| | 1 | +17 | N/A | N/A | N/A | N/A | N/A |
| | 2 | N/A | N/A | +56 | +61 | N/A | N/A |
| | 3 | N/A | N/A | +62 | +79 | +61 | N/A |
| | 4 | N/A | N/A | N/A | +62 | +81 | N/A |
| | 5 | N/A | N/A | N/A | N/A | +58 | +86 |

IF = 2500 MHz, RF = 20,000 MHz, LO = 17,500 MHz, RF power = -10 dBm, LO power = 18 dBm, and $T_A = 25^\circ\text{C}$.

| | | N x LO | | | | | |
|--------|---|--------|-----|-----|-----|-----|-----|
| | | 0 | 1 | 2 | 3 | 4 | 5 |
| M x RF | 0 | N/A | 12 | 32 | N/A | N/A | N/A |
| | 1 | 14 | 0 | 26 | 47 | 59 | N/A |
| | 2 | 64 | 73 | 72 | 63 | 71 | 60 |
| | 3 | N/A | 63 | 72 | 80 | 79 | 73 |
| | 4 | N/A | N/A | 64 | 73 | 77 | 80 |
| | 5 | N/A | N/A | N/A | 60 | 71 | 64 |

IF = 2500 MHz, RF = 30,000 MHz, LO = 27,500 MHz, RF power = -10 dBm, LO power = 18 dBm, and $T_A = 25^\circ\text{C}$.

| | | N x LO | | | | | |
|--------|---|--------|-----|-----|-----|-----|-----|
| | | 0 | 1 | 2 | 3 | 4 | 5 |
| M x RF | 0 | N/A | 8 | N/A | N/A | N/A | N/A |
| | 1 | 19 | 0 | 52 | N/A | N/A | N/A |
| | 2 | N/A | 69 | 66 | 70 | 60 | N/A |
| | 3 | N/A | N/A | 68 | 80 | 75 | 57 |
| | 4 | N/A | N/A | N/A | 67 | 76 | 76 |
| | 5 | N/A | N/A | N/A | N/A | 65 | 80 |

IF = 2500 MHz, RF = 40,000 MHz, LO = 37,500 MHz, RF power = -10 dBm, LO power = 18 dBm, and $T_A = 25^\circ\text{C}$.

| | | N x LO | | | | | |
|--------|---|--------|-----|-----|-----|-----|-----|
| | | 0 | 1 | 2 | 3 | 4 | 5 |
| M x RF | 0 | N/A | -8 | N/A | N/A | N/A | N/A |
| | 1 | +17 | 0 | +43 | N/A | N/A | N/A |
| | 2 | N/A | +59 | +59 | +66 | N/A | N/A |
| | 3 | N/A | N/A | +57 | +76 | +65 | N/A |
| | 4 | N/A | N/A | N/A | +55 | +77 | +66 |
| | 5 | N/A | N/A | N/A | N/A | +57 | +77 |

IF = 5000 MHz, RF = 20,000 MHz, LO = 15,000 MHz, RF power = -10 dBm, LO power = 18 dBm, and $T_A = 25^\circ\text{C}$.

| | | N x LO | | | | | |
|--------|---|--------|-----|-----|-----|-----|-----|
| | | 0 | 1 | 2 | 3 | 4 | 5 |
| M x RF | 0 | N/A | -4 | +26 | +30 | N/A | N/A |
| | 1 | +13 | 0 | +24 | +35 | +46 | N/A |
| | 2 | +45 | +35 | +24 | N/A | +13 | +53 |
| | 3 | N/A | +30 | +26 | -4 | N/A | -4 |
| | 4 | N/A | N/A | +54 | +53 | +13 | N/A |
| | 5 | N/A | N/A | N/A | N/A | +40 | +35 |

IF = 5000 MHz, RF = 30,000 MHz, LO = 25,000 MHz, RF power = -10 dBm, LO power = 18 dBm, and $T_A = 25^\circ\text{C}$.

| | | N x LO | | | | | |
|--------|---|--------|-----|-----|-----|-----|-----|
| | | 0 | 1 | 2 | 3 | 4 | 5 |
| M x RF | 0 | N/A | 6 | 34 | N/A | N/A | N/A |
| | 1 | 18 | 0 | 37 | 61 | N/A | N/A |
| | 2 | N/A | 63 | 72 | 73 | 65 | N/A |
| | 3 | N/A | N/A | 65 | 73 | 68 | 65 |
| | 4 | N/A | N/A | N/A | 61 | 37 | N/A |
| | 5 | N/A | N/A | N/A | NA | 34 | 6 |

IF = 5000 MHz, RF = 40,000 MHz, LO = 35,000 MHz, RF power = -10 dBm, LO power = 18 dBm, and T_A = 25°C.

| | | N × LO | | | | | |
|--------|---|--------|-----|-----|-----|-----|-----|
| | | 0 | 1 | 2 | 3 | 4 | 5 |
| M × RF | 0 | N/A | 4 | N/A | N/A | N/A | N/A |
| | 1 | 17 | 0 | 44 | N/A | N/A | N/A |
| | 2 | N/A | 57 | 65 | 69 | N/A | N/A |
| | 3 | N/A | N/A | 56 | 73 | 69 | N/A |
| | 4 | N/A | N/A | N/A | N/A | 72 | 74 |
| | 5 | N/A | N/A | N/A | N/A | N/A | 70 |

IF = 2500 MHz, RF = 20,000 MHz, LO = 22,500 MHz, RF power = -10 dBm, LO power = 18 dBm, and T_A = 25°C.

| | | N × LO | | | | | |
|--------|---|--------|-----|-----|-----|-----|-----|
| | | 0 | 1 | 2 | 3 | 4 | 5 |
| M × RF | 0 | N/A | 3 | 32 | N/A | N/A | N/A |
| | 1 | 15 | 0 | 41 | 59 | N/A | N/A |
| | 2 | 66 | 77 | 73 | 72 | 61 | N/A |
| | 3 | N/A | 64 | 78 | 77 | 72 | N/A |
| | 4 | N/A | N/A | 67 | 78 | 81 | 72 |
| | 5 | N/A | N/A | N/A | 70 | 81 | 80 |

IF = 100 MHz, RF = 20,000 MHz, LO = 20,100 MHz, RF power = -10 dBm, LO power = 18 dBm, and T_A = 25°C.

| | | N × LO | | | | | |
|--------|---|--------|-----|-----|-----|-----|-----|
| | | 0 | 1 | 2 | 3 | 4 | 5 |
| M × RF | 0 | N/A | 11 | 36 | N/A | N/A | N/A |
| | 1 | 14 | 0 | 53 | 63 | N/A | N/A |
| | 2 | 69 | 77 | 67 | 75 | 67 | N/A |
| | 3 | N/A | 66 | 77 | 67 | 76 | 66 |
| | 4 | N/A | N/A | 66 | 75 | 88 | 77 |
| | 5 | N/A | N/A | N/A | 65 | 76 | 89 |

IF = 2500 MHz, RF = 30,000 MHz, LO = 32,500 MHz, RF power = -10 dBm, LO power = 18 dBm, and T_A = 25°C.

| | | N × LO | | | | | |
|--------|---|--------|-----|-----|-----|-----|-----|
| | | 0 | 1 | 2 | 3 | 4 | 5 |
| M × RF | 0 | N/A | -2 | N/A | N/A | N/A | N/A |
| | 1 | +18 | 0 | +41 | N/A | N/A | +18 |
| | 2 | N/A | +71 | +63 | +64 | N/A | N/A |
| | 3 | N/A | N/A | +72 | +79 | +65 | N/A |
| | 4 | N/A | N/A | N/A | +73 | +79 | N/A |
| | 5 | N/A | N/A | N/A | N/A | +76 | N/A |

IF = 100 MHz, RF = 30,000 MHz, LO = 29,900 MHz, RF power = -10 dBm, LO power = 18 dBm, and T_A = 25°C.

| | | N × LO | | | | | |
|--------|---|--------|-----|-----|-----|-----|-----|
| | | 0 | 1 | 2 | 3 | 4 | 5 |
| M × RF | 0 | N/A | 2 | N/A | N/A | N/A | N/A |
| | 1 | 19 | 0 | 49 | N/A | N/A | N/A |
| | 2 | N/A | 73 | 71 | 71 | N/A | N/A |
| | 3 | N/A | N/A | 71 | 83 | 71 | N/A |
| | 4 | N/A | N/A | N/A | 72 | 90 | 73 |
| | 5 | N/A | N/A | N/A | N/A | 74 | 89 |

IF = 100 MHz, RF = 20,000 MHz, LO = 25,000 MHz, RF power = -10 dBm, LO power = 18 dBm, and T_A = 25°C.

| | | N × LO | | | | | |
|--------|---|--------|-----|----|-----|-----|-----|
| | | 0 | 1 | 2 | 3 | 4 | 5 |
| M × RF | 0 | N/A | 7 | 34 | N/A | N/A | N/A |
| | 1 | 15 | 0 | 64 | N/A | N/A | N/A |
| | 2 | 65 | 80 | 75 | 67 | N/A | N/A |
| | 3 | N/A | 67 | 77 | 78 | 67 | N/A |
| | 4 | N/A | N/A | 67 | N/A | 15 | 40 |
| | 5 | N/A | N/A | 40 | 7 | N/A | 7 |

IF = 100 MHz, RF = 40,000 MHz, LO = 39,900 MHz, RF power = -10 dBm, LO power = 18 dBm, and T_A = 25°C.

| | | N × LO | | | | | |
|--------|---|--------|-----|-----|-----|-----|-----|
| | | 0 | 1 | 2 | 3 | 4 | 5 |
| M × RF | 0 | N/A | -3 | N/A | N/A | N/A | N/A |
| | 1 | +17 | 0 | +46 | N/A | N/A | N/A |
| | 2 | N/A | +61 | +56 | +61 | N/A | N/A |
| | 3 | N/A | N/A | +61 | +83 | +61 | N/A |
| | 4 | N/A | N/A | N/A | +63 | +83 | +62 |
| | 5 | N/A | N/A | N/A | N/A | +64 | +85 |

IF = 2500 MHz, RF = 30,000 MHz, LO = 35,000 MHz, RF power = -10 dBm, LO power = 18 dBm, and T_A = 25°C.

| | | N × LO | | | | | |
|--------|---|--------|-----|-----|-----|-----|-----|
| | | 0 | 1 | 2 | 3 | 4 | 5 |
| M × RF | 0 | N/A | 5 | N/A | N/A | N/A | N/A |
| | 1 | 18 | 0 | 48 | N/A | N/A | N/A |
| | 2 | N/A | 71 | 76 | 60 | N/A | N/A |
| | 3 | N/A | N/A | 75 | 75 | 59 | N/A |
| | 4 | N/A | N/A | 58 | 76 | 74 | N/A |
| | 5 | N/A | N/A | N/A | 59 | 76 | 71 |

Upconverter M × N Spurious Outputs

Mixer spurious products are measured in dBc from the RF output power level, unless otherwise specified. Hybrid loss is not de-embedded.

IF = 100 MHz, RF = 20,000 MHz, LO = 19,900 MHz, IF power = -10 dBm, LO power = 18 dBm, and T_A = 25°C.

| | | N × LO | | | | | |
|--------|-----|--------|----|-----|-----|-----|-----|
| | | 0 | 1 | 2 | 3 | 4 | 5 |
| M × IF | -5 | 90 | 79 | 70 | N/A | N/A | N/A |
| | -4 | 92 | 78 | 70 | N/A | N/A | N/A |
| | -3 | 93 | 78 | 69 | N/A | N/A | N/A |
| | -2 | 91 | 67 | 69 | N/A | N/A | N/A |
| | -1 | 43 | 20 | 31 | N/A | N/A | N/A |
| | 0 | N/A | 7 | 24 | N/A | N/A | N/A |
| | +1 | 43 | 0 | 42 | N/A | N/A | N/A |
| | +2 | 93 | 60 | 69 | N/A | N/A | N/A |
| | +3 | 90 | 81 | 70 | N/A | N/A | N/A |
| | +4 | 92 | 79 | 71 | N/A | N/A | N/A |
| +5 | N/A | 81 | 71 | N/A | N/A | N/A | |

IF = 100 MHz, RF = 30,000 MHz, LO = 29,900 MHz, IF power = -10 dBm, LO power = 18 dBm, and T_A = 25°C.

| | | N × LO | | | | | |
|--------|-----|--------|-----|-----|-----|-----|-----|
| | | 0 | 1 | 2 | 3 | 4 | 5 |
| M × IF | -5 | 91 | 74 | N/A | N/A | N/A | N/A |
| | -4 | 91 | 75 | N/A | N/A | N/A | N/A |
| | -3 | 91 | 69 | N/A | N/A | N/A | N/A |
| | -2 | 92 | 69 | N/A | N/A | N/A | N/A |
| | -1 | 43 | 19 | N/A | N/A | N/A | N/A |
| | 0 | N/A | N/A | N/A | N/A | N/A | N/A |
| | +1 | 43 | 0 | N/A | N/A | N/A | N/A |
| | +2 | 91 | 58 | N/A | N/A | N/A | N/A |
| | +3 | 92 | 73 | N/A | N/A | N/A | N/A |
| | +4 | 91 | 74 | N/A | N/A | N/A | N/A |
| +5 | N/A | 72 | N/A | N/A | N/A | N/A | |

IF = 100 MHz, RF = 40,000 MHz, LO = 39,900 MHz, IF power = -10 dBm, LO power = 18 dBm, and T_A = 25°C.

| | | N × LO | | | | | |
|--------|-----|--------|-----|-----|-----|-----|-----|
| | | 0 | 1 | 2 | 3 | 4 | 5 |
| M × IF | -5 | +90 | +68 | N/A | N/A | N/A | N/A |
| | -4 | +89 | +66 | N/A | N/A | N/A | N/A |
| | -3 | +90 | +65 | N/A | N/A | N/A | N/A |
| | -2 | +65 | +60 | N/A | N/A | N/A | N/A |
| | -1 | +41 | +18 | N/A | N/A | N/A | N/A |
| | 0 | N/A | -8 | N/A | N/A | N/A | N/A |
| | +1 | +41 | N/A | N/A | N/A | N/A | N/A |
| | +2 | +90 | +58 | N/A | N/A | N/A | N/A |
| | +3 | +90 | +67 | N/A | N/A | N/A | N/A |
| | +4 | +90 | +66 | N/A | N/A | N/A | N/A |
| +5 | N/A | +67 | N/A | N/A | N/A | N/A | |

IF = 2500 MHz, RF = 20,000 MHz, LO = 17,500 MHz, IF power = -10 dBm, LO power = 18 dBm, and T_A = 25°C.

| | | N × LO | | | | | |
|--------|----|--------|----|-----|-----|-----|-----|
| | | 0 | 1 | 2 | 3 | 4 | 5 |
| M × IF | -5 | 81 | 81 | 75 | 67 | N/A | N/A |
| | -4 | 81 | 82 | 75 | 66 | N/A | N/A |
| | -3 | 81 | 83 | 75 | 64 | N/A | N/A |
| | -2 | 82 | 80 | 64 | 63 | N/A | N/A |
| | -1 | 17 | 23 | 22 | 38 | N/A | N/A |
| | 0 | N/A | 7 | 18 | N/A | N/A | N/A |
| | +1 | 17 | 0 | 31 | N/A | N/A | N/A |
| | +2 | 81 | 75 | 66 | N/A | N/A | N/A |
| | +3 | 82 | 75 | 66 | N/A | N/A | N/A |
| | +4 | 80 | 75 | 65 | N/A | N/A | N/A |
| +5 | 78 | 64 | 62 | N/A | N/A | N/A | |

IF = 2500 MHz, RF = 30,000 MHz, LO = 27,500 MHz, IF power = -10 dBm, LO power = 18 dBm, and T_A = 25°C.

| | | N × LO | | | | | |
|--------|----|--------|-----|-----|-----|-----|-----|
| | | 0 | 1 | 2 | 3 | 4 | 5 |
| M × IF | -5 | 79 | 77 | 65 | N/A | N/A | N/A |
| | -4 | 80 | 77 | 62 | N/A | N/A | N/A |
| | -3 | 81 | 74 | 61 | N/A | N/A | N/A |
| | -2 | 80 | 66 | 61 | N/A | N/A | N/A |
| | -1 | 14 | 16 | N/A | N/A | N/A | N/A |
| | 0 | N/A | N/A | N/A | N/A | N/A | N/A |
| | +1 | 14 | 0 | N/A | N/A | N/A | N/A |
| | +2 | 79 | 71 | N/A | N/A | N/A | N/A |
| | +3 | 77 | 66 | N/A | N/A | N/A | N/A |
| | +4 | 81 | 64 | N/A | N/A | N/A | N/A |
| +5 | 79 | 67 | N/A | N/A | N/A | N/A | |

IF = 2500 MHz, RF = 40,000 MHz, LO = 37,500 MHz, IF power = -10 dBm, LO power = 18 dBm, and T_A = 25°C.

| | | N × LO | | | | | |
|--------|-----|--------|-----|-----|-----|-----|-----|
| | | 0 | 1 | 2 | 3 | 4 | 5 |
| M × IF | -5 | +80 | +72 | N/A | N/A | N/A | N/A |
| | -4 | +79 | +71 | N/A | N/A | N/A | N/A |
| | -3 | +80 | +70 | N/A | N/A | N/A | N/A |
| | -2 | +78 | +65 | N/A | N/A | N/A | N/A |
| | -1 | +15 | +18 | N/A | N/A | N/A | N/A |
| | 0 | N/A | -4 | N/A | N/A | N/A | N/A |
| | +1 | +15 | 0 | N/A | N/A | N/A | N/A |
| | +2 | +80 | +65 | N/A | N/A | N/A | N/A |
| | +3 | +80 | +61 | N/A | N/A | N/A | N/A |
| | +4 | +76 | +60 | N/A | N/A | N/A | N/A |
| +5 | +77 | +59 | N/A | N/A | N/A | N/A | |

IF = 5000 MHz, RF = 20,000 MHz, LO = 15,000 MHz, IF power = -10 dBm, LO power = 18 dBm, and $T_A = 25^\circ\text{C}$.

| | | N × LO | | | | | |
|--------|----|--------|-----|-----|-----|-----|-----|
| | | 0 | 1 | 2 | 3 | 4 | 5 |
| M × IF | -5 | 21 | 32 | 12 | N/A | 29 | 45 |
| | -4 | N/A | 12 | 32 | 22 | 22 | N/A |
| | -3 | 7 | N/A | 7 | 7 | 15 | N/A |
| | -2 | 31 | 12 | N/A | 29 | 45 | N/A |
| | -1 | 12 | 32 | 22 | 22 | N/A | N/A |
| | 0 | N/A | 7 | 7 | 14 | N/A | N/A |
| | +1 | 12 | 0 | 29 | 45 | N/A | N/A |
| | +2 | 32 | 22 | 22 | N/A | N/A | N/A |
| | +3 | 7 | 7 | 14 | N/A | N/A | N/A |
| | +4 | N/A | 29 | 45 | N/A | N/A | N/A |
| +5 | 22 | 22 | N/A | N/A | N/A | N/A | |

IF = 5000 MHz, RF = 30,000 MHz, LO = 25,000 MHz, IF power = -10 dBm, LO power = 18 dBm, and $T_A = 25^\circ\text{C}$.

| | | N × LO | | | | | |
|--------|----|--------|-----|-----|-----|-----|-----|
| | | 0 | 1 | 2 | 3 | 4 | 5 |
| M × IF | -5 | 1 | N/A | 1 | 17 | | |
| | -4 | 13 | 9 | N/A | N/A | N/A | N/A |
| | -3 | 70 | 79 | 66 | N/A | N/A | N/A |
| | -2 | 80 | 70 | 64 | N/A | N/A | N/A |
| | -1 | 9 | 13 | 38 | N/A | N/A | N/A |
| | 0 | N/A | 1 | 18 | N/A | N/A | N/A |
| | +1 | 9 | 0 | N/A | N/A | N/A | N/A |
| | +2 | 78 | 64 | N/A | N/A | N/A | N/A |
| | +3 | 71 | 67 | N/A | N/A | N/A | N/A |
| | +4 | 13 | 36 | N/A | N/A | N/A | N/A |
| +5 | 1 | 18 | N/A | N/A | N/A | N/A | |

IF = 5000 MHz, RF = 40,000 MHz, LO = 35,000 MHz, IF power = -10 dBm, LO power = 18 dBm, and $T_A = 25^\circ\text{C}$.

| | | N × LO | | | | | |
|--------|-----|--------|-----|-----|-----|-----|-----|
| | | 0 | 1 | 2 | 3 | 4 | 5 |
| M × IF | -5 | +72 | +79 | +60 | +72 | N/A | N/A |
| | -4 | +74 | +77 | +60 | +74 | N/A | N/A |
| | -3 | +76 | +71 | N/A | N/A | N/A | N/A |
| | -2 | +55 | +72 | N/A | N/A | N/A | N/A |
| | -1 | +8 | +15 | N/A | N/A | N/A | N/A |
| | 0 | N/A | -2 | N/A | N/A | N/A | N/A |
| | +1 | +8 | 0 | +8 | N/A | N/A | N/A |
| | +2 | +76 | +58 | +76 | N/A | N/A | N/A |
| | +3 | +76 | +58 | +76 | N/A | N/A | N/A |
| | +4 | +76 | N/A | +76 | N/A | N/A | N/A |
| +5 | +71 | N/A | +71 | N/A | N/A | N/A | |

IF = 100 MHz, RF = 20,000 MHz, LO = 20,100 MHz, IF power = -10 dBm, LO power = 18 dBm, and $T_A = 25^\circ\text{C}$.

| | | N × LO | | | | | |
|--------|----|--------|----|-----|-----|-----|-----|
| | | 0 | 1 | 2 | 3 | 4 | 5 |
| M × IF | -5 | 92 | 80 | 69 | 92 | N/A | N/A |
| | -4 | 92 | 79 | 68 | 92 | N/A | N/A |
| | -3 | 92 | 80 | 71 | 92 | N/A | N/A |
| | -2 | 93 | 57 | 68 | N/A | N/A | N/A |
| | -1 | 43 | 0 | 38 | N/A | N/A | N/A |
| | 0 | N/A | 6 | 27 | N/A | N/A | N/A |
| | +1 | 43 | 21 | 31 | N/A | N/A | N/A |
| | +2 | 94 | 71 | 65 | N/A | N/A | N/A |
| | +3 | 94 | 68 | 69 | N/A | N/A | N/A |
| | +4 | 92 | 79 | 70 | N/A | N/A | N/A |
| +5 | 91 | 79 | 70 | N/A | N/A | N/A | |

IF = 100 MHz, RF = 30,000 MHz, LO = 30,100 MHz, IF power = -10 dBm, LO power = 18 dBm, and $T_A = 25^\circ\text{C}$.

| | | N × LO | | | | | |
|--------|----|--------|-----|-----|-----|-----|-----|
| | | 0 | 1 | 2 | 3 | 4 | 5 |
| M × IF | -5 | 92 | 73 | N/A | N/A | N/A | N/A |
| | -4 | 92 | 73 | N/A | N/A | N/A | N/A |
| | -3 | 90 | 72 | N/A | N/A | N/A | N/A |
| | -2 | 92 | 61 | N/A | N/A | N/A | N/A |
| | -1 | 43 | 0 | N/A | N/A | N/A | N/A |
| | 0 | N/A | 2 | N/A | N/A | N/A | N/A |
| | +1 | 43 | 19 | N/A | N/A | N/A | N/A |
| | +2 | 93 | 68 | N/A | N/A | N/A | N/A |
| | +3 | 93 | 73 | N/A | N/A | N/A | N/A |
| | +4 | 91 | 72 | N/A | N/A | N/A | N/A |
| +5 | 91 | 74 | N/A | N/A | N/A | N/A | |

IF = 100 MHz, RF = 40,000 MHz, LO = 40,100 MHz, IF power = -10 dBm, LO power = 18 dBm, and $T_A = 25^\circ\text{C}$.

| | | N × LO | | | | | |
|--------|-----|--------|-----|-----|-----|-----|-----|
| | | 0 | 1 | 2 | 3 | 4 | 5 |
| M × IF | -5 | +90 | +64 | N/A | N/A | N/A | N/A |
| | -4 | +90 | +66 | N/A | N/A | N/A | N/A |
| | -3 | +92 | +68 | N/A | N/A | N/A | N/A |
| | -2 | +91 | +53 | N/A | N/A | N/A | N/A |
| | -1 | +41 | 0 | N/A | N/A | N/A | N/A |
| | 0 | N/A | -8 | N/A | N/A | N/A | N/A |
| | +1 | +41 | +18 | N/A | N/A | N/A | N/A |
| | +2 | +65 | +64 | N/A | N/A | N/A | N/A |
| | +3 | +93 | +66 | N/A | N/A | N/A | N/A |
| | +4 | +91 | +67 | N/A | N/A | N/A | N/A |
| +5 | +90 | +67 | N/A | N/A | N/A | N/A | |

IF = 2500 MHz, RF = 20,000 MHz, LO = 22,500 MHz, IF power = -10 dBm, LO power = 18 dBm, and T_A = 25°C.

| | | N × LO | | | | | |
|--------|----|--------|-----|-----|-----|-----|-----|
| | | 0 | 1 | 2 | 3 | 4 | 5 |
| M × IF | -5 | 82 | 80 | 70 | N/A | N/A | N/A |
| | -4 | 81 | 82 | 67 | N/A | N/A | N/A |
| | -3 | 82 | 79 | 66 | N/A | N/A | N/A |
| | -2 | 81 | 79 | 63 | N/A | N/A | N/A |
| | -1 | 17 | 0 | 40 | N/A | N/A | N/A |
| | 0 | N/A | 5 | 21 | N/A | N/A | N/A |
| | +1 | 17 | 24 | 42 | N/A | N/A | N/A |
| | +2 | 82 | 74 | 63 | N/A | N/A | N/A |
| | +3 | 80 | 72 | N/A | N/A | N/A | N/A |
| | +4 | 81 | 73 | N/A | N/A | N/A | N/A |
| +5 | 79 | 68 | N/A | N/A | N/A | N/A | |

IF = 2500 MHz, RF = 30,000 MHz, LO = 32,500 MHz, IF power = -10 dBm, LO power = 18 dBm, and T_A = 25°C.

| | | N × LO | | | | | |
|--------|-----|--------|-----|-----|-----|-----|-----|
| | | 0 | 1 | 2 | 3 | 4 | 5 |
| M × IF | -5 | +81 | +77 | N/A | N/A | N/A | N/A |
| | -4 | +79 | +74 | N/A | N/A | N/A | N/A |
| | -3 | +79 | +72 | N/A | N/A | N/A | N/A |
| | -2 | +79 | +62 | N/A | N/A | N/A | N/A |
| | -1 | +15 | 0 | N/A | N/A | N/A | N/A |
| | 0 | N/A | -4 | N/A | N/A | N/A | N/A |
| | +1 | +15 | +19 | N/A | N/A | N/A | N/A |
| | +2 | +78 | +62 | N/A | N/A | N/A | N/A |
| | +3 | +75 | +66 | N/A | N/A | N/A | N/A |
| | +4 | +78 | +64 | N/A | N/A | N/A | N/A |
| +5 | +80 | +64 | N/A | N/A | N/A | N/A | |

IF = 5000 MHz, RF = 20,000 MHz, LO = 25,000 MHz, IF power = -10 dBm, LO power = 18 dBm, and T_A = 25°C.

| | | N × LO | | | | | |
|--------|----|--------|-----|-----|-----|-----|-----|
| | | 0 | 1 | 2 | 3 | 4 | 5 |
| M × IF | -5 | 1 | N/A | 1 | 18 | | |
| | -4 | N/A | 12 | 19 | N/A | N/A | N/A |
| | -3 | 71 | 76 | 68 | N/A | N/A | N/A |
| | -2 | 80 | 70 | 66 | N/A | N/A | N/A |
| | -1 | 12 | 0 | 42 | N/A | N/A | N/A |
| | 0 | N/A | 1 | 18 | N/A | N/A | N/A |
| | +1 | 12 | 18 | N/A | N/A | N/A | N/A |
| | +2 | 73 | 67 | N/A | N/A | N/A | N/A |
| | +3 | 71 | 66 | N/A | N/A | N/A | N/A |
| | +4 | N/A | 42 | N/A | N/A | N/A | N/A |
| +5 | 1 | 19 | N/A | N/A | N/A | N/A | |

IF = 5000 MHz, RF = 30,000 MHz, LO = 35,000 MHz, IF power = -10 dBm, LO power = 18 dBm, and T_A = 25°C.

| | | N × LO | | | | | |
|--------|-----|--------|-----|-----|-----|-----|-----|
| | | 0 | 1 | 2 | 3 | 4 | 5 |
| M × IF | -5 | +68 | +78 | +60 | N/A | N/A | N/A |
| | -4 | +74 | +77 | +59 | N/A | N/A | N/A |
| | -3 | +77 | +74 | N/A | N/A | N/A | N/A |
| | -2 | +74 | +70 | N/A | N/A | N/A | N/A |
| | -1 | +9 | 0 | N/A | N/A | N/A | N/A |
| | 0 | N/A | -6 | N/A | N/A | N/A | N/A |
| | +1 | +9 | +16 | N/A | N/A | N/A | N/A |
| | +2 | +53 | +58 | N/A | N/A | N/A | N/A |
| | +3 | +75 | +59 | N/A | N/A | N/A | N/A |
| | +4 | +73 | N/A | N/A | N/A | N/A | N/A |
| +5 | +70 | N/A | N/A | N/A | N/A | N/A | |

THEORY OF OPERATION

The HMC8192LG is a passive, wideband, I/Q MMIC mixer that can be used either as an image rejection mixer for receiver operations or as a single-sideband upconverter for transmitter operations. With an RF and LO range of 20 GHz to 42 GHz and an IF bandwidth of dc to 5 GHz, the HMC8192LG is ideal for applications requiring a wide frequency range, excellent RF performance, and a simple design with fewer components and a small PCB footprint. A single HMC8192LG can replace multiple narrow-band mixers in a design.

The inherent I/Q architecture of the HMC8192LG offers excellent image rejection, eliminating the need for expensive filtering for unwanted sidebands. The double balanced architecture of the mixer also provides excellent LO to RF isolation and LO to IF isolation, and reduces the effect of LO leakage to ensure signal integrity.

Because the HMC8192LG is a passive mixer, the HMC8192LG does not require any dc power sources. The HMC8192LG offers a lower noise figure compared to an active mixer, ensuring superior dynamic range for high performance and precision applications.

The HMC8192LG is fabricated on a GaAs MESFET process and uses Analog Devices mixer cells and a 90° hybrid. The HMC8192LG is available in a compact, 4.00 mm × 4.00 mm, 25-terminal LGA_CAV package and operates over a -40°C to +85°C temperature range. The evaluation board for the HMC8192LG, [EV1HMC8192LG](#), is also available on the Analog Devices website.

For both upconversion and downconversion, an external 90° hybrid is required. See the Applications Information section for details on interfacing with an external 90° hybrid.

APPLICATIONS INFORMATION

Figure 121 shows the typical application circuit for the HMC8192LG. To select the appropriate sideband, an external 90° hybrid is needed. For applications not requiring operation to dc, use an off-chip dc blocking capacitor. For applications that require the LO signal at the output to be suppressed, use a bias tee or RF feed as shown in Figure 121. Ensure that the source or sink current used for LO suppression is greater than 3 mA for each IFx port to prevent damage to the device. The common-mode voltage for each IFx port is 0 V.

To select the upper sideband when using the HMC8192LG as an upconverter, connect the IF1 pin to the 90° port of the hybrid and connect the IF2 pin to the 0° port of the hybrid. To select the lower sideband, connect the IF1 pin to the 0° port of the hybrid and the IF2 pin to the 90° port of the hybrid. The input is from the sum port of the hybrid, and the difference port is 50 Ω terminated.

To select the upper sideband (low-side LO) when using the HMC8192LG as a downconverter, connect the IF1 pin to the 0° port of the hybrid and connect the IF2 pin to the 90° port of the hybrid. To select the lower sideband (high-side LO), connect the IF1 pin to the 90° port of the hybrid and the IF2 pin to the 0° port of the hybrid. The output is from the sum port of the hybrid, and the difference port is 50 Ω terminated.

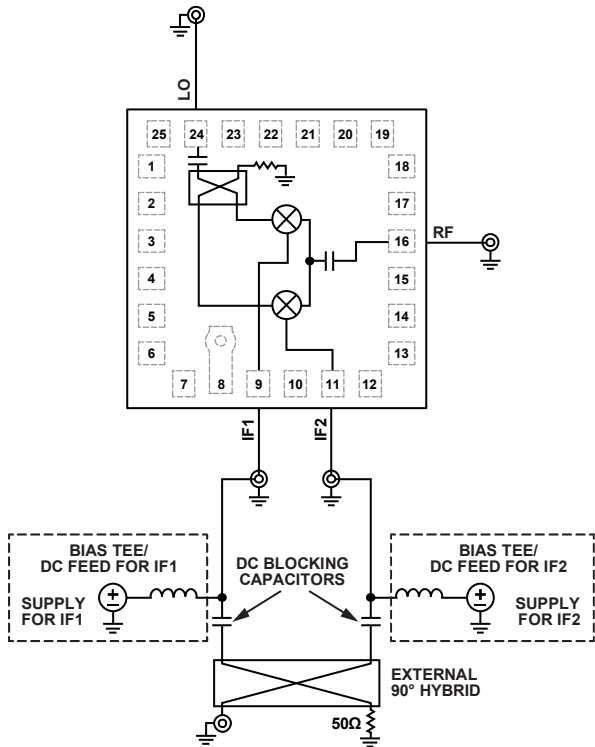

NOTES
1. DASHED SECTIONS ARE OPTIONAL AND MEANT FOR LO NULLING.

Figure 121. Typical Application Circuit

15697-121

LAYOUT

Solder the exposed pad on the underside of the HMC8192LG to a low thermal and electrical impedance ground plane. This pad is typically soldered to an exposed opening in the solder mask on the evaluation board. Connect these ground vias to all other ground layers on the evaluation board to maximize heat dissipation from the device package.

EVALUATION BOARD INFORMATION

The EV1HMC8192LG evaluation board PCB used in the application must use RF circuit design techniques. Signal lines must have a 50 Ω impedance and connect the package ground leads and exposed pad directly to the ground plane, similar to the setup shown in Figure 123. Use a sufficient number of via holes to connect the top and bottom ground planes.

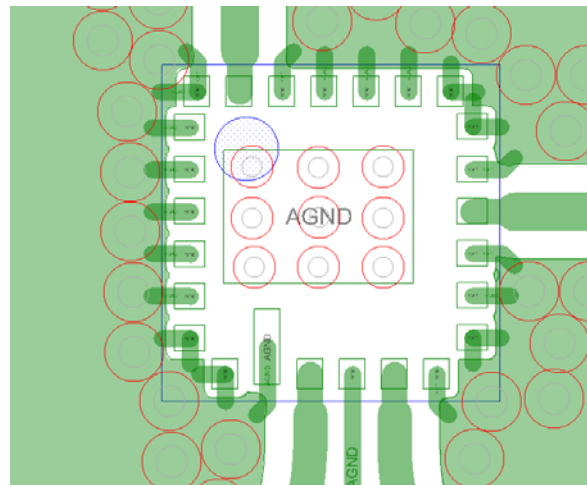

Figure 122. Evaluation Board Layout for the HMC8192LG

15697-122

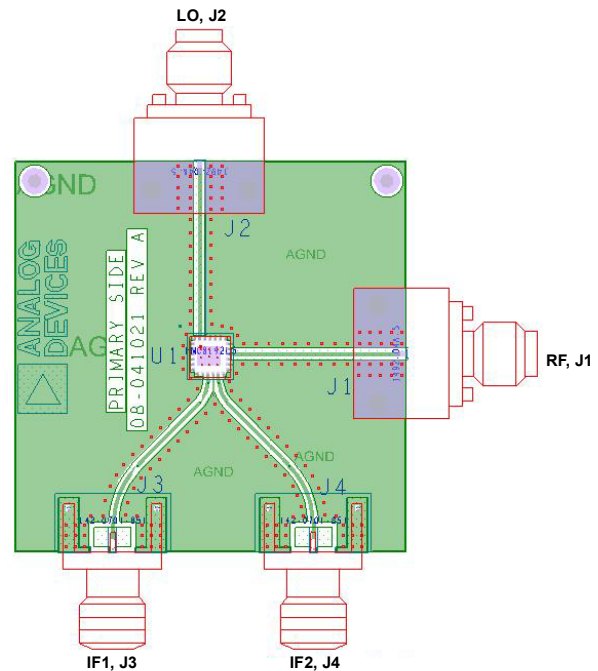

Figure 123. EV1HMC8192LG Evaluation Board PCB, Top Layer

15697-123

Table 6. Bill of Materials for the EV1HMC8192LG¹
Evaluation Board PCB

| Quantity | Reference Designator | Description | Manufacturer |
|----------|----------------------|---|---------------------|
| 1 | Not applicable | PCB, EV1HMC8192LG ² | Analog Devices |
| 2 | J1, J2 | PCB connector, end launch SMA edge mount | Southwest Microwave |
| 2 | J3, J4 | PCB connector, jack assembly, end launch, SMA | CINCH |
| 1 | U1 | Device under test, HMC8192LG | Analog Devices |

¹ Reference this number when ordering the evaluation board PCB.
² Circuit board material: RO4350B™ laminates.

PERFORMANCE AT LOWER IF FREQUENCIES

The HMC8192LG can operate at low IF frequencies approaching dc. Figure 124 shows the conversion gain and image rejection performance at lower IF frequencies for upconversion. Figure 125 shows the conversion gain and image rejection performance at lower IF frequencies for downconversion. This performance is typical and is not guaranteed.

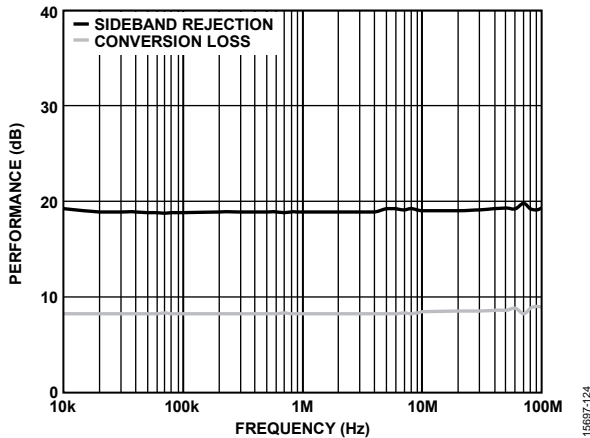

Figure 124. IF Bandwidth as Upconverter at Low IF Frequencies, LO = 25 GHz, 18 dBm, Upper Sideband

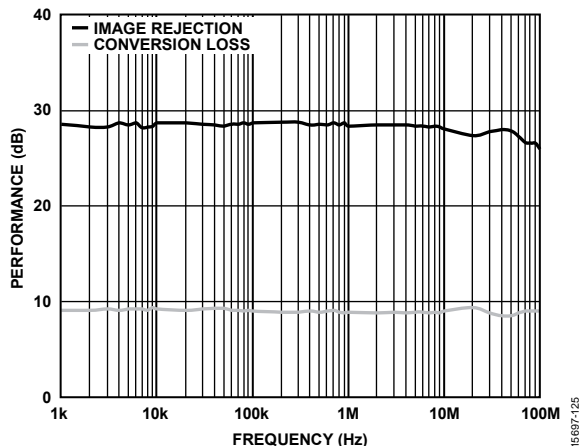

Figure 125. IF Bandwidth as Downconverter at Low IF Frequencies, LO = 25 GHz, 18 dBm, Upper Sideband

PERFORMANCE AT HIGHER IF FREQUENCIES

Figure 126 and Figure 127 show the IF performance above 5 GHz. The data for Figure 126 was taken as an upconverter configuration with a lower sideband at an LO frequency of 31 GHz and an LO power of 18 dBm. The data for Figure 127 was taken as a downconverter configuration with a lower sideband at an LO frequency of 31 GHz and an LO power of 18 dBm. This performance is typical and is not guaranteed.

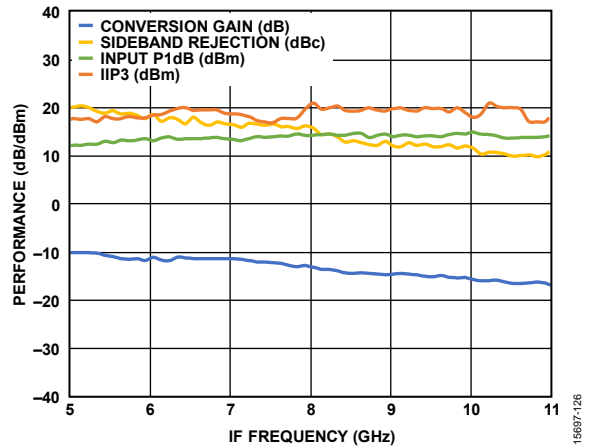

Figure 126. IF Bandwidth at IF Frequencies Above 5 GHz, Data Taken as Upconverter, Lower Sideband, LO = 31 GHz at 18 dBm, T_A = 25°C

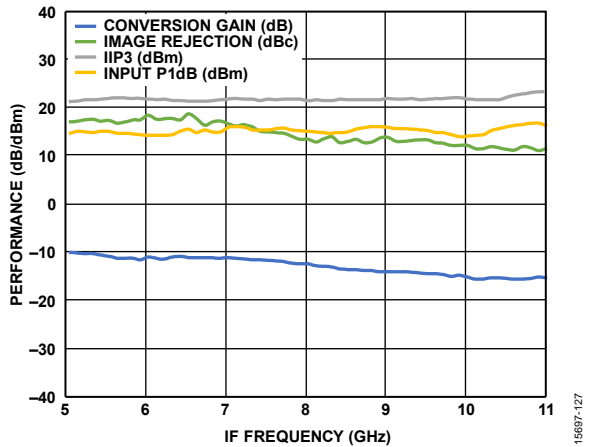
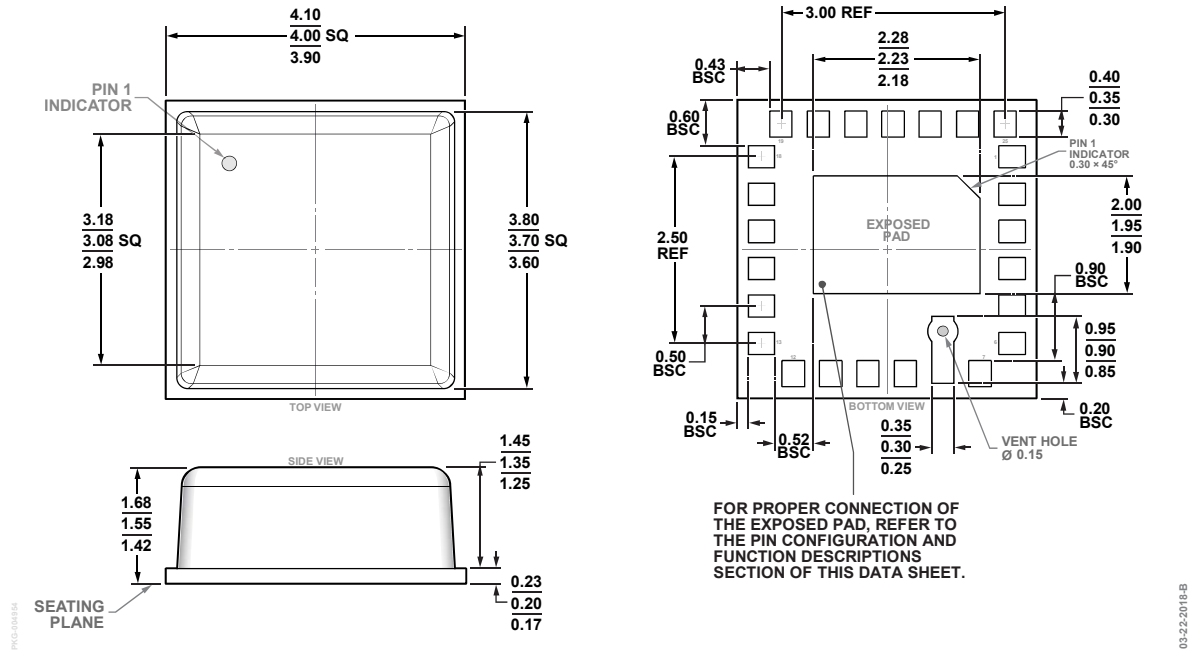

Figure 127. IF Bandwidth at IF Frequencies Above 5 GHz, Data Taken as Downconverter, Lower Sideband (High-Side LO), LO = 31 GHz at 18 dBm, T_A = 25°C

OUTLINE DIMENSIONS



FOR PROPER CONNECTION OF THE EXPOSED PAD, REFER TO THE PIN CONFIGURATION AND FUNCTION DESCRIPTIONS SECTION OF THIS DATA SHEET.

ORDERING GUIDE

| Model ¹ | Temperature Range | Package Description | MSL Rating ² | Package Option |
|--------------------|-------------------|-------------------------|-------------------------|----------------|
| HMC8192LG | -40°C to +85°C | 25-Terminal LGA_CAV | MSL3 | CE-25-1 |
| HMC8192LGTR | -40°C to +85°C | 25-Terminal LGA_CAV | MSL3 | CE-25-1 |
| EV1HMC8192LG | | Evaluation PCB Assembly | | |

¹ The HMC8192LG and the HMC8192LGTR are RoHS compliant parts.

² See the Absolute Maximum Ratings section.