

## GENERAL DESCRIPTION

The SP6686 is a current-regulated charge pump ideal for powering high brightness LEDs for camera flash applications.

The charge pump can be set to regulate two current levels for FLASH and TORCH modes. The SP6686 automatically switches modes between step-up and step-down ensuring that LED current does not depend on the forward voltage. A low current sense reference voltage (50mV) allows the use of small 0603 current sensing resistors.

The SP6686 is designed to operate from a single cell lithium-ion battery or fixed 3.3V or 5.0V power rails and is available in a RoHS compliant, "green"/halogen free space saving 10-pin 3mmx3mm DFN package

## APPLICATIONS

- **White LED Torch/Flash for Mobile Phones, DSCs and Camcorders**
- **Generic Lighting/Flash/Strobe Applications**
- **White LED Backlighting**

## FEATURES

- **Output Current up to 400mA**
- **Up to 94% Efficiency in Torch Mode**
- **Adjustable FLASH Mode**
- **x1 and x2 Automatic Modes for High Efficiency**
- **Minimum External Components: No Inductors**
- **2.4MHz High Frequency Operation**
- **1 $\mu$ A Shutdown Current**
- **Built-In Soft Start Limit Inrush Current**
- **Output Overvoltage Protection**
- **Over current/Temperature Protection**
- **10-pin 3mm x 3mm DFN Package**

## TYPICAL APPLICATION DIAGRAM

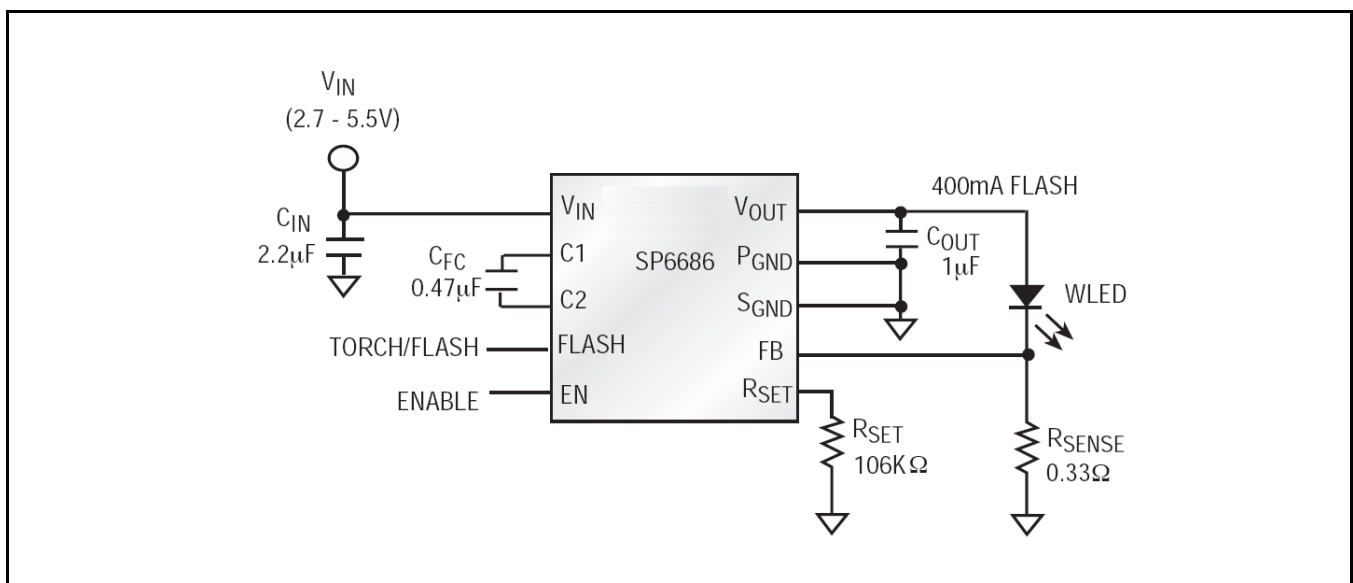

Fig. 1: SP6686 Application Diagram

**ABSOLUTE MAXIMUM RATINGS**

These are stress ratings only and functional operation of the device at these ratings or any other above those indicated in the operation sections of the specifications below is not implied. Exposure to absolute maximum rating conditions for extended periods of time may affect reliability.

$V_{IN}, V_{OUT}$  ..... -0.3V to 6.0V  
 Output Current Pulse (FLASH) ..... 500mA  
 Output Current Continuous (TORCH)..... 200mA  
 $V_{EN}$  ..... 0V to 7V  
 Storage Temperature ..... -65°C to 150°C  
 Lead Temperature (Soldering, 10 sec) ..... 260°C  
 ESD Rating EN pin (HBM - Human Body Model) ..... 1kV  
 ESD Rating All Other Pins (HBM) ..... 2kV

**OPERATING RATINGS**

Input Voltage Range  $V_{IN}$ .....2.7V to 5.5V  
 Operating Temperature Range..... -40°C to 85°C  
 Thermal Resistance  $\theta_{JA}$  .....57.1°C/W

**ELECTRICAL SPECIFICATIONS**

Specifications with standard type are for an Operating Junction Temperature of  $T_J = 25^\circ\text{C}$  only; limits applying over the full Operating Junction Temperature range are denoted by a “•”. Minimum and Maximum limits are guaranteed through test, design, or statistical correlation. Typical values represent the most likely parametric norm at  $T_J = 25^\circ\text{C}$ , and are provided for reference purposes only. Unless otherwise indicated,  $V_{IN} = V_{SHTDN} = 3.6\text{V}$ ,  $C_{IN} = 2.2\mu\text{F}$ ,  $C_{FC} = 0.47\mu\text{F}$ ,  $C_{OUT} = 1\mu\text{F}$ .  $T_A = -40^\circ\text{C}$  to  $85^\circ\text{C}$ .

Parameter	Min.	Typ.	Max.	Units	Conditions
Operating Input Voltage	2.7		5.5	V	•
Quiescent Current		0.5	3	mA	• $V_{IN} = 2.7 - 5.5\text{V}$ FLASH = 0V $I_{LOAD} = 100\mu\text{A}$
		2			FLASH = $V_{IN}$ , 2x Mode
Shutdown Current			1	$\mu\text{A}$	$V_{IN} = 5.5\text{V}, V_{EN} = 0\text{V}$
Oscillator Frequency		2.4		MHz	
Charge Pump Equivalent Resistance (x2 Mode)		5		$\Omega$	$V_{FB} = 0\text{V}, V_{IN} = 3.6\text{V}$
Charge Pump Equivalent Resistance (x1 Mode)		0.6	0.8	$\Omega$	$V_{IN} = 3.6\text{V}$
FB Reference Voltage	138	150	162	mV	• FLASH = $V_{IN}$ , $R_{SET} = 106\text{k}\Omega$
FB Reference Voltage	45	50	55	mV	• FLASH = GND
FB Pin Current			0.5	$\mu\text{A}$	$V_{FB} = 0.3\text{V}$
EN, Flash Logic Low			0.4	V	•
EN, Flash Logic High	1.3			V	•
EN, Flash Pin Current			0.5	$\mu\text{A}$	•
$V_{OUT}$ Turn-on Time		250	500	$\mu\text{s}$	• $V_{IN} = 3.6\text{V}$ , FB within 90% of regulation
Thermal Shutdown Temperature		145		$^\circ\text{C}$	

**BLOCK DIAGRAM**

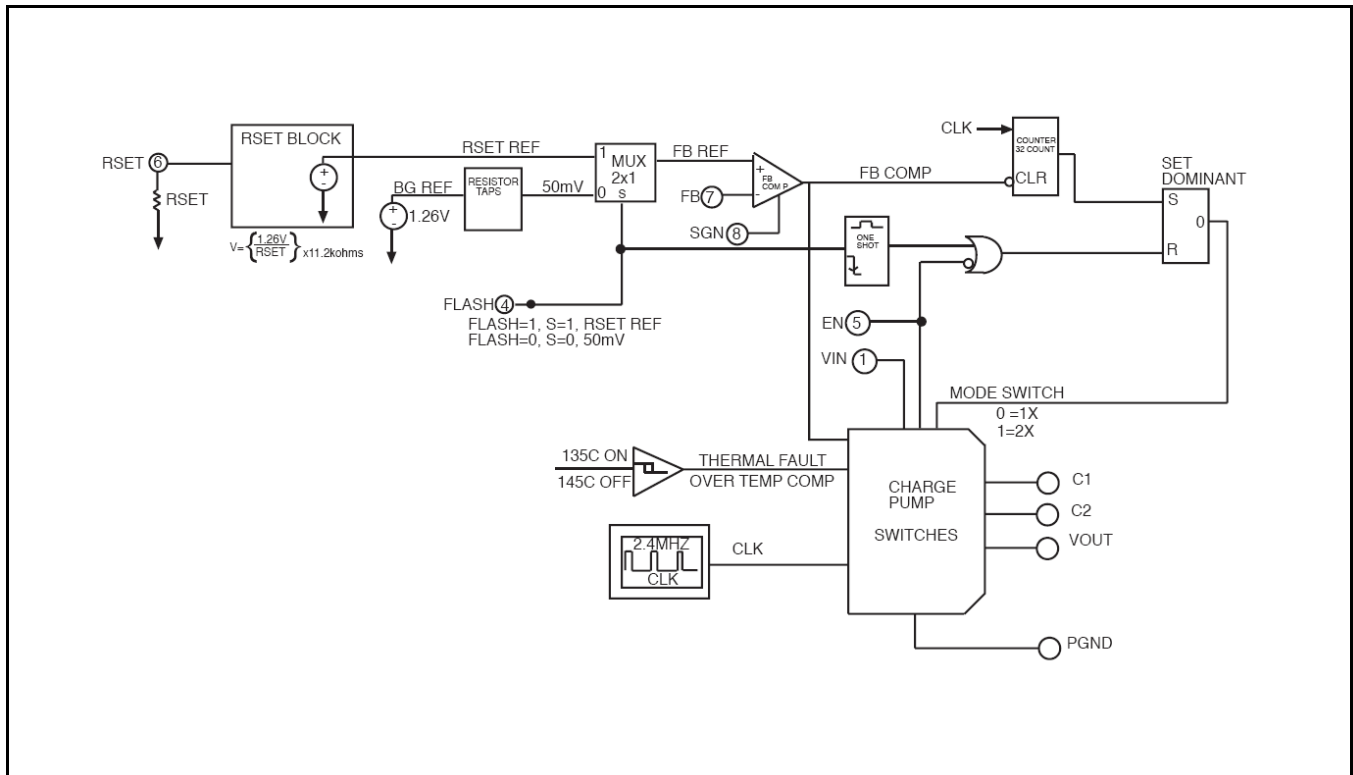

Fig. 2: SP6686 Block Diagram

**PIN ASSIGNMENT**

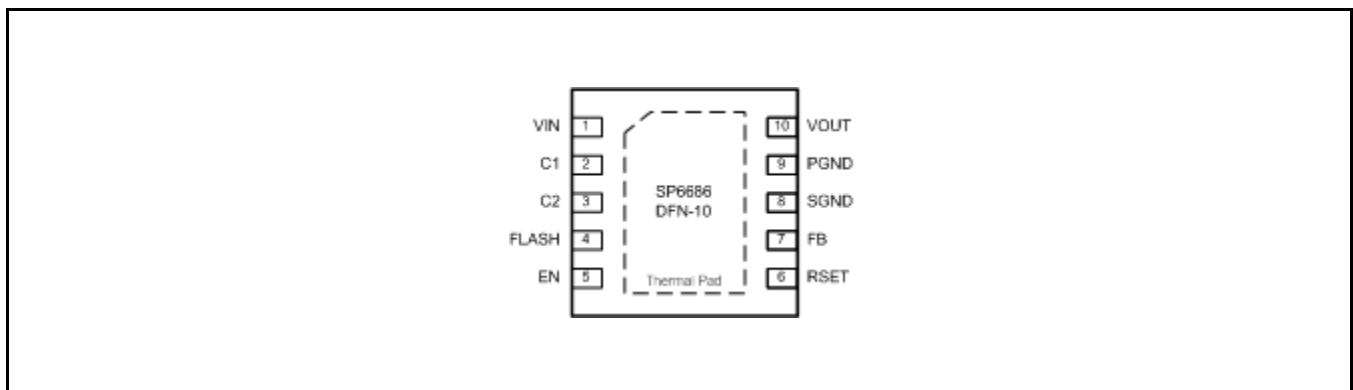

Fig. 3: SP6686 Pin Assignment

**PIN DESCRIPTION**

Name	Pin Number	Description
V <sub>IN</sub>	1	Input voltage for the charge pump. Decouple with 2.2μF ceramic capacitor close to the pins of the IC.
C1	2	Positive input for the external fly capacitor. Connect a ceramic 0.47μF capacitor close to the pins of the IC.
C2	3	Negative input for the external fly capacitor. Connect a ceramic 0.47μF capacitor close to the pins of the IC.
FLASH	4	Logic input to toggle between FLASH and TORCH mode. In TORCH Mode FB is regulated to the internal 50mV reference. In FLASH Mode FB reference voltage can be adjusted by changing the resistor from R <sub>SET</sub> pin to ground. Choose the external current sense Resistor (R <sub>SENSE</sub> ) based on desired current in TORCH Mode.
EN	5	Shutdown control input. Connect to V <sub>IN</sub> for normal operation, connect to ground for shutdown.
R <sub>SET</sub>	6	Connect a resistor from this pin to ground. When in FLASH Mode (FLASH = High) this resistor sets the current regulation point according to the following: $V_{FB} = (1.26V/R_{SET}) * 11.2K\Omega$
FB	7	Feedback input for the current control loop. Connect directly to the current sense resistor.
S <sub>GND</sub>	8	Internal ground pin. Control circuitry returns current to this pin.
P <sub>GND</sub>	9	Power ground pin. Fly capacitor current returns through this pin.
V <sub>OUT</sub>	10	Charge Pump Output Voltage. Decouple with an external capacitor. At least 1μF is recommended. Higher capacitor values reduce output ripple.

**ORDERING INFORMATION<sup>(1)</sup>**

Part Number	Temperature Range	Package	Packing Method	Lead free <sup>(2)</sup>
SP6686ER-L/TR	-40°C ≤ T <sub>A</sub> ≤ +85°C	DFN-10	Tape & Reel	Yes
SP6686EB	SP6686 Evaluation Board			

Notes:

1. Refer to [www.maxlinear.com/SP6686](http://www.maxlinear.com/SP6686) for most up-to-date Ordering Information.
2. Visit [www.maxlinear.com](http://www.maxlinear.com) for additional information on Environmental Rating.

**TYPICAL PERFORMANCE CHARACTERISTICS**

All data taken at  $V_{IN} = 3.6V$ ,  $T_A = 25^\circ C$ , unless otherwise specified - Schematic and BOM from Application Information section of this datasheet. D1 = AOT 2015HPW-1915B LED.

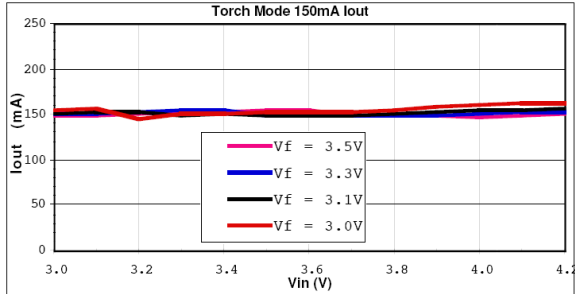

Fig. 4: Output Current vs Supply Voltage  
 $C_{IN}=2.2\mu F$ ,  $C_{FC}=0.47\mu F$ ,  $C_{OUT}=1\mu F$

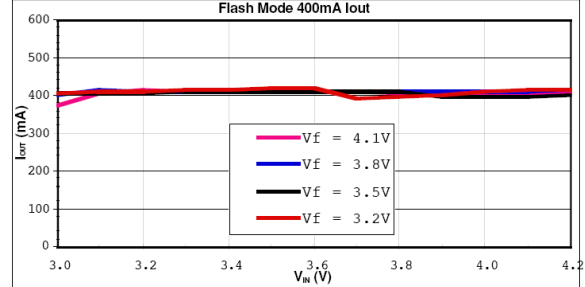

Fig. 5: Output Current vs Supply Voltage  
 $C_{IN}=2.2\mu F$ ,  $C_{FC}=0.47\mu F$ ,  $C_{OUT}=1\mu F$

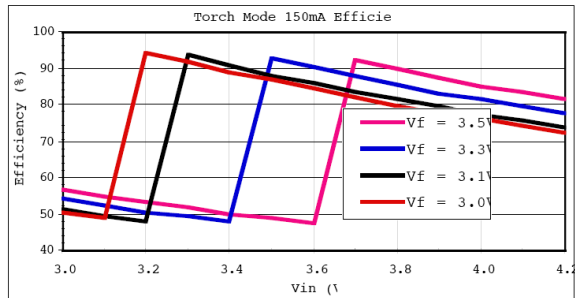

Fig. 6: Efficiency vs Supply Voltage  
 $C_{IN}=2.2\mu F$ ,  $C_{FC}=0.47\mu F$ ,  $C_{OUT}=1\mu F$

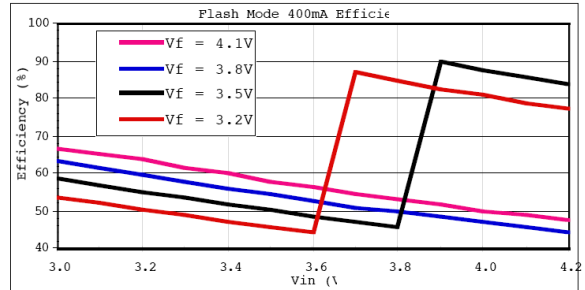

Fig. 7: Efficiency vs Supply Voltage  
 $C_{IN}=2.2\mu F$ ,  $C_{FC}=0.47\mu F$ ,  $C_{OUT}=1\mu F$

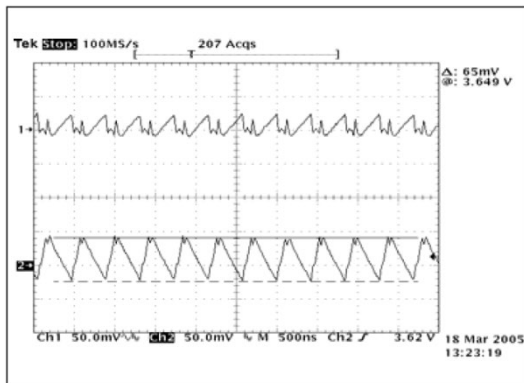

Fig. 8: Ripple 1x Flash 400mA, Ch1= $V_{IN}$ , Ch2= $V_{OUT}$   
 $V_{IN}=4.2V$ ,  $C_{IN}=4.7\mu F$ ,  $C_{FC}=0.47\mu F$ ,  $C_{OUT}=2.2\mu F$

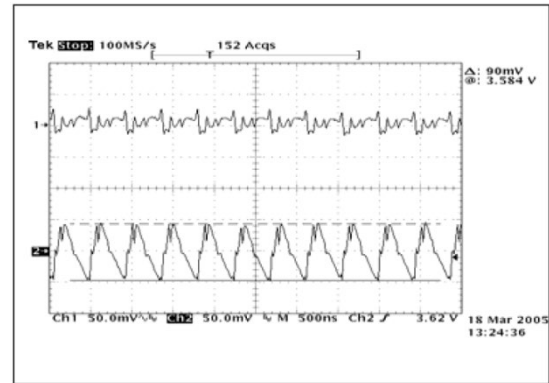

Fig. 9: Ripple 2x Flash 400mA, Ch1= $V_{IN}$ , Ch2= $V_{OUT}$   
 $V_{IN}=3.6V$ ,  $C_{IN}=4.7\mu F$ ,  $C_{FC}=0.47\mu F$ ,  $C_{OUT}=2.2\mu F$

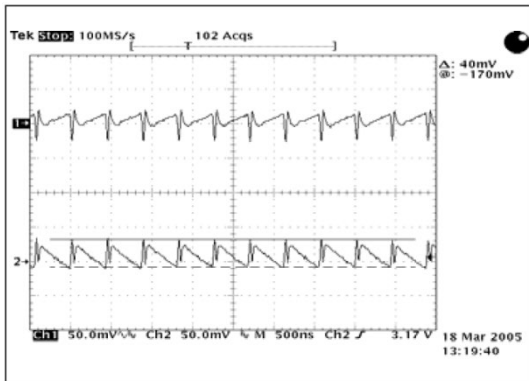

Fig. 10: Ripple 1x Torch 150mA, Ch1=V<sub>IN</sub>, Ch2=V<sub>OUT</sub>  
 V<sub>IN</sub>=4.2V, C<sub>IN</sub>=4.7μF, C<sub>FC</sub>=0.47μF, C<sub>OUT</sub>=2.2μF

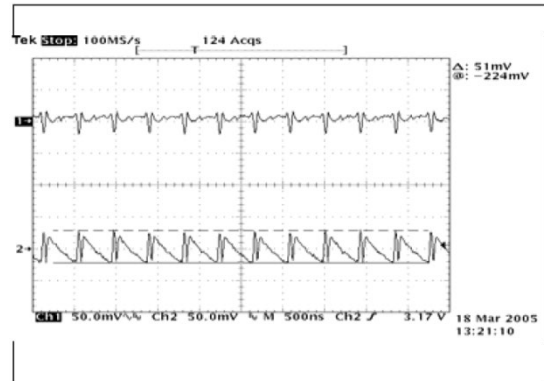

Fig. 11: Ripple 2x Torch 150mA, Ch1=V<sub>IN</sub>, Ch2=V<sub>OUT</sub>  
 V<sub>IN</sub>=3.0V, C<sub>IN</sub>=4.7μF, C<sub>FC</sub>=0.47μF, C<sub>OUT</sub>=2.2μF

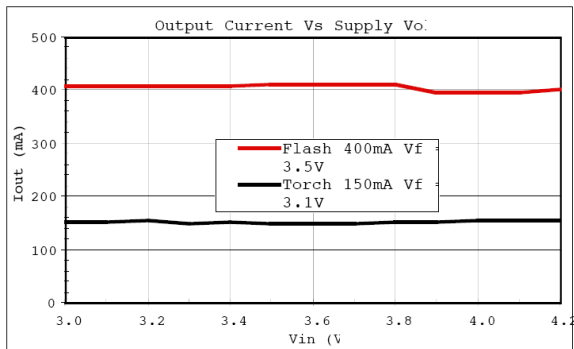

Fig. 12: Output Current vs Supply Voltage  
 D1=AOT2015HPW-1915 LED, R<sub>SENSE</sub>=0.3Ω  
 R<sub>SET</sub>=106kΩ, C<sub>IN</sub>=2.2μF, C<sub>FC</sub>=0.47μF, C<sub>OUT</sub>=1μF

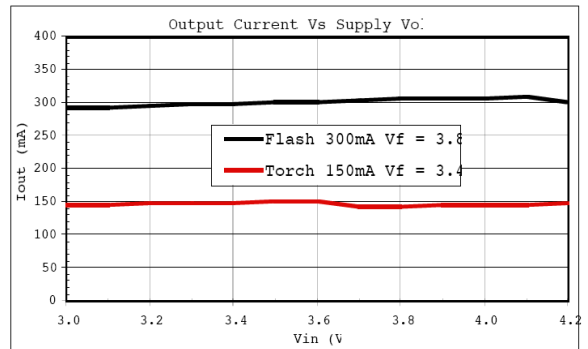

Fig. 13: Output Current vs Supply Voltage  
 D1=AOT3228HPW0303B LED, R<sub>SENSE</sub>=0.3Ω  
 R<sub>SET</sub>=140kΩ, C<sub>IN</sub>=2.2μF, C<sub>FC</sub>=0.47μF, C<sub>OUT</sub>=1μF

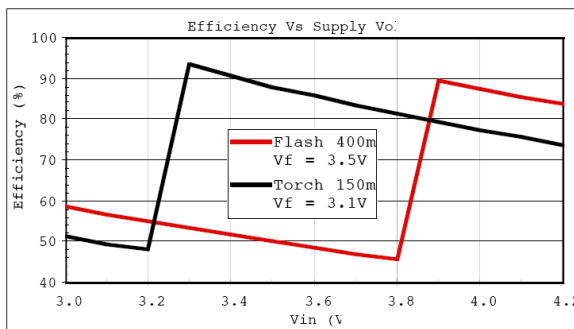

Fig. 14: Efficiency vs Supply Voltage  
 D1=AOT2015HPW-1915 LED, R<sub>SENSE</sub>=0.3Ω  
 R<sub>SET</sub>=106kΩ, C<sub>IN</sub>=2.2μF, C<sub>FC</sub>=0.47μF, C<sub>OUT</sub>=1μF

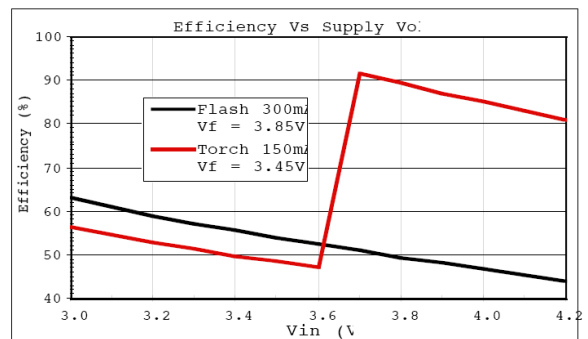

Fig. 15: Efficiency vs Supply Voltage  
 D1=AOT3228HPW0303B LED, R<sub>SENSE</sub>=0.3Ω  
 R<sub>SET</sub>=140kΩ, C<sub>IN</sub>=2.2μF, C<sub>FC</sub>=0.47μF, C<sub>OUT</sub>=1μF

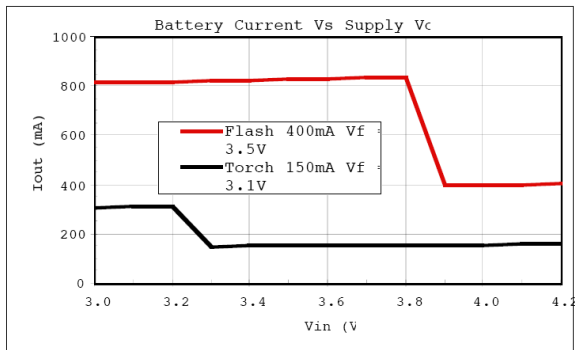

Fig. 16: Battery Current vs Supply Voltage  
 D1=AOT2015HPW-1915 LED,  $R_{SENSE}=0.3\Omega$   
 $R_{SET}=106k\Omega$ ,  $C_{IN}=2.2\mu F$ ,  $C_{FC}=0.47\mu F$ ,  $C_{OUT}=1\mu F$

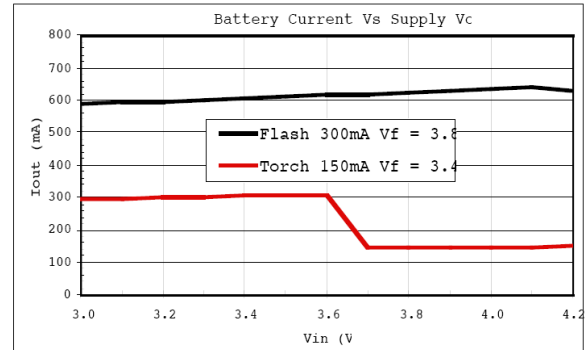

Fig. 17: Battery Current vs Supply Voltage  
 D1=AOT3228HPW0303B LED,  $R_{SENSE}=0.3\Omega$   
 $R_{SET}=140k\Omega$ ,  $C_{IN}=2.2\mu F$ ,  $C_{FC}=0.47\mu F$ ,  $C_{OUT}=1\mu F$

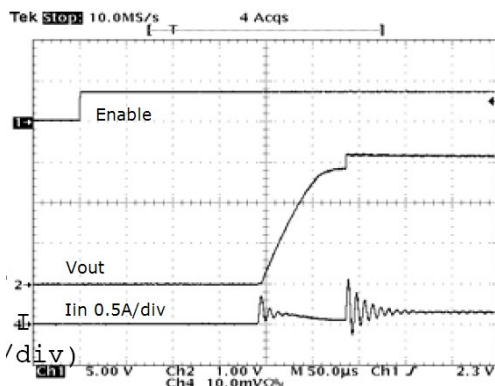

Fig. 18: Startup Torch  
 $V_{IN}=3.6V$ ,  $V_{OUT}=3.1V$ ,  $C_{IN}=4.7\mu F$ ,  $C_{FC}=0.47\mu F$ ,  $C_{OUT}=2.2\mu F$

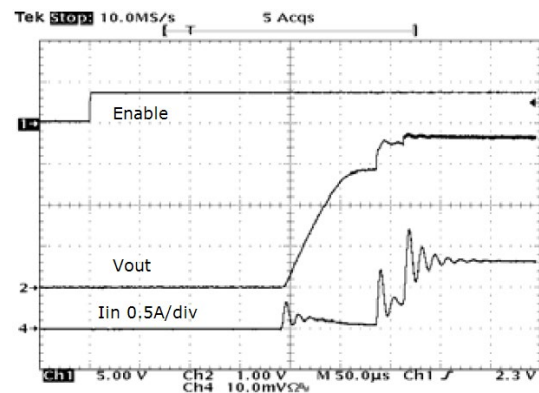

Fig. 19: Startup Flash  
 $V_{IN}=3.6V$ ,  $V_{OUT}=3.5V$ ,  $C_{IN}=4.7\mu F$ ,  $C_{FC}=0.47\mu F$ ,  $C_{OUT}=2.2\mu F$

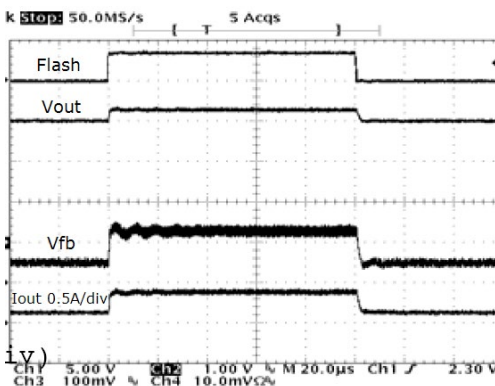

Fig. 20: Torch in 1x to Flash in 1x Mode  
 $V_{IN}=4.2V$ ,  $C_{IN}=4.7\mu F$ ,  $C_{FC}=0.47\mu F$ ,  $C_{OUT}=2.2\mu F$

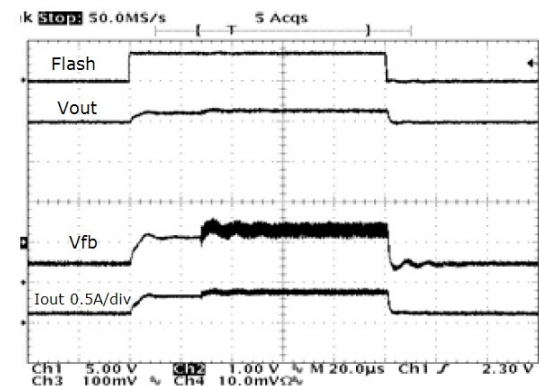

Fig. 21: Torch in 1x to Flash in 2x Mode  
 $V_{IN}=3.6V$ ,  $C_{IN}=4.7\mu F$ ,  $C_{FC}=0.47\mu F$ ,  $C_{OUT}=2.2\mu F$

## THEORY OF OPERATION

The SP6686 is a charge pump regulator designed for converting a Li-Ion battery voltage of 2.7V to 4.2V to drive a white LED used in digital still camera Flash and Torch applications. The SP6686 has two modes of operation which are pin selectable for either Flash or Torch. Flash mode is usually used with a pulse of about 200 to 300 milliseconds to generate a high intensity Flash. Torch can be used continuously at a lower output current than Flash and is often used for several seconds in a digital still camera "movie" mode.

The SP6686 also has two modes of operation to control the output current, the 1x mode and 2x mode. Operation begins after the enable pin EN receives a logic high, the bandgap reference wakes up after 200µsec, and then SP6686 goes through a soft-start mode designed to reduce inrush current. The SP6686 starts in the 1x mode, which acts like a linear regulator to control the output current by continuously monitoring the feedback pin FB. In 1x mode, if the SP6686 auto detects a dropout condition, which is when the FB pin is below the regulation point for more than 32 cycles of the internal clock, the SP6686 automatically switches to the 2x mode. The SP6686 remains in the 2x mode until one of four things happens:

- 1) The enable pin EN has been toggled
- 2) The Flash pin has changed from high to low
- 3)  $V_{IN}$  is cycled
- 4) A thermal fault occurs

The 2X mode is the charge pump mode where the output can be pumped as high as two times the input voltage, provided the output does not exceed the maximum voltage for the SP6686, which is internally limited to about 5.5V. In the 2x mode, as in the 1x mode, the output current is regulated by the voltage at the FB pin.

In the Torch mode, (Flash = GND) the Flash pin is set to logic low and the SP6686 FB pin regulates to 50mV output:

$$V_{FB} = 50mV \text{ (Torch Mode)}$$

When in Flash mode, (Flash =  $V_{IN}$ ), the FB regulation voltage is set by the resistor  $R_{SET}$  connected between the  $R_{SET}$  pin and SGND and the equation:

$$V_{FB} = \left( \frac{1.26V}{R_{SET}} \right) \times 11.2k\Omega \text{ (Flash Mode)}$$

Where 1.26V is the internal bandgap reference voltage and 11.2kΩ is an internal resistance used to scale the  $R_{SET}$  current. Typical values of  $R_{SET}$  are 40kΩ to 180kΩ for a range of  $V_{FB}$  = 300mV to 75mV in Flash mode.

The output current is then set in either Flash or Torch mode by the equation:

$$I_{OUT} = \frac{V_{FB}}{R_{SENSE}}$$

## OVER TEMPERATURE PROTECTION

When the temperature of the SP6686 rises above 145°C, the over temperature protection circuitry turns off the output switches to prevent damage to the device. If the temperature drops back down below 135°C, the part automatically recovers and executes a soft start cycle.

## OVER VOLTAGE PROTECTION

The SP6686 has over voltage protection. If the output voltage rises above the 5.5V threshold, the over voltage protection shuts off all of the output switches to prevent the output voltage from rising further. When the output decreases below 5.5V, the device resumes normal operation

## OVER CURRENT PROTECTION

The over current protection circuitry monitors the average current out of the  $V_{OUT}=50mV$  (Torch Mode) pin. If the average output current exceeds approximately 1Amp, then the over current protection circuitry shuts off the output switches to protect the chip.

## COMPONENT SELECTION

The SP6686 charge pump circuit requires 3 capacitors: 4.7µF input, 1µF output and



0.47μF fly capacitor are typically recommended. For the input capacitor, a larger value of 10μF will help reduce input voltage ripple for applications sensitive to ripple on the battery voltage. All the capacitors should be ceramic to obtain low ESR, which improves bypassing on the input and output and improves output voltage drive by reducing output resistance. X5R or X7R Ceramic capacitors are recommended for most applications. A selection of recommended capacitors is included in Table 1. The input and output capacitors should be located as close to the V<sub>IN</sub> and V<sub>OUT</sub> pins as possible to obtain best bypassing, and the returns should be connected directly to the PGND pin or to the thermal pad ground located under the SP6686. The fly capacitor should be located as close to the C1 and C2 pins as possible. The sense resistor R<sub>SENSE</sub> is determined by the value needed in the Torch mode for the desired output current by the equation:

$$R_{SENSE} = \frac{V_{FB}}{I_{OUT}}$$

Where V<sub>FB</sub>=50mV in torch mode.

Once the R<sub>SENSE</sub> resistor has been selected for Torch mode, the V<sub>FB</sub> voltage can be selected for Flash mode using the following equation:

$$V_{FB} = I_{OUT} \times R_{SENSE} \text{ (Flash Mode)}$$

Where I<sub>OUT</sub> is for Flash Mode

Next, the R<sub>SET</sub> resistor can be selected for Flash mode using the following equation:

$$R_{SET} = \left( \frac{1.26V}{V_{FB}} \right) \times 11.2k\Omega \text{ (Flash Mode)}$$

For an example of 150mA Torch mode and 400mA Flash mode, the values R<sub>SENSE</sub>=0.33Ω, V<sub>FB</sub>=135mV (Flash Mode), and R<sub>SET</sub>=106kΩ are calculated. The power obtained in the Flash mode would be:

$$P_{FLASH} = V_{FB} \times I_{OUT} = 133mV \times 400mA = 53mW$$

The typical 0603 surface mount resistor is rated at 1/10 Watt continuous power and 1/5 Watt pulsed power, more than enough for this application. For other applications, the PFLASH can be calculated from the resistor size selected. The R<sub>SENSE</sub> resistor is recommended to be size 0603 for most applications.

### EVALUATION BOARD LAYOUT

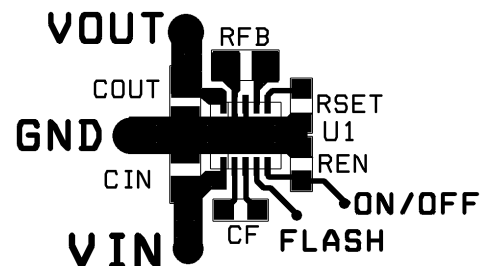

Manufacturer	Part Number	Value	Size/Type	ESR
TDK	C1005X5R0J474K	0.47uF/6.3V	0402/X5R/0.55mm	0.03
TDK	C1005X5R0J105K	1uF/6.3V	0402/X5R/0.55mm	0.03
TDK	C1608X5R0J225K	2.2uF/6.3V	0603/X5R/0.9mm	0.03
TDK	C1608X5R0J475K	4.7uF/6.3V	0603/X5R/0.9mm	0.02
Murata	GRM155R60J474KE19D	0.47uF/6.3V	0402/X5R/0.55mm	0.03
Murata	GRM155R60J105KE19D	1uF/6.3V	0402/X5R/0.55mm	0.03
Murata	GRM188R60J225KE19D	2.2uF/6.3V	0603/X5R/0.8mm	0.03
Murata	GRM188R60J475KE19D	4.7uF/6.3V	0603/X5R/0.8mm	0.02

Table 1: Recommended Capacitors

Part Reference	Value	Tolerance	Size
R <sub>SET</sub>	68K $\Omega$	5%	0402
R <sub>SET</sub>	75K $\Omega$	5%	0402
R <sub>SET</sub>	82K $\Omega$	5%	0402
R <sub>SET</sub>	91K $\Omega$	5%	0402
R <sub>SET</sub>	100K $\Omega$	5%	0402
R <sub>SET</sub>	110K $\Omega$	5%	0402
R <sub>SET</sub>	120K $\Omega$	5%	0402
R <sub>SET</sub>	130K $\Omega$	5%	0402
R <sub>SET</sub>	140K $\Omega$	5%	0402
R <sub>SET</sub>	150K $\Omega$	5%	0402
R <sub>SENSE</sub>	0.22 $\Omega$	5%	0603
R <sub>SENSE</sub>	0.27 $\Omega$	5%	0603
R <sub>SENSE</sub>	0.33 $\Omega$	5%	0603
R <sub>SENSE</sub>	0.39 $\Omega$	5%	0603
R <sub>SENSE</sub>	0.47 $\Omega$	5%	0603

Table 2: Resistor Value and Sizes

PACKAGE SPECIFICATION

10-PIN DFN

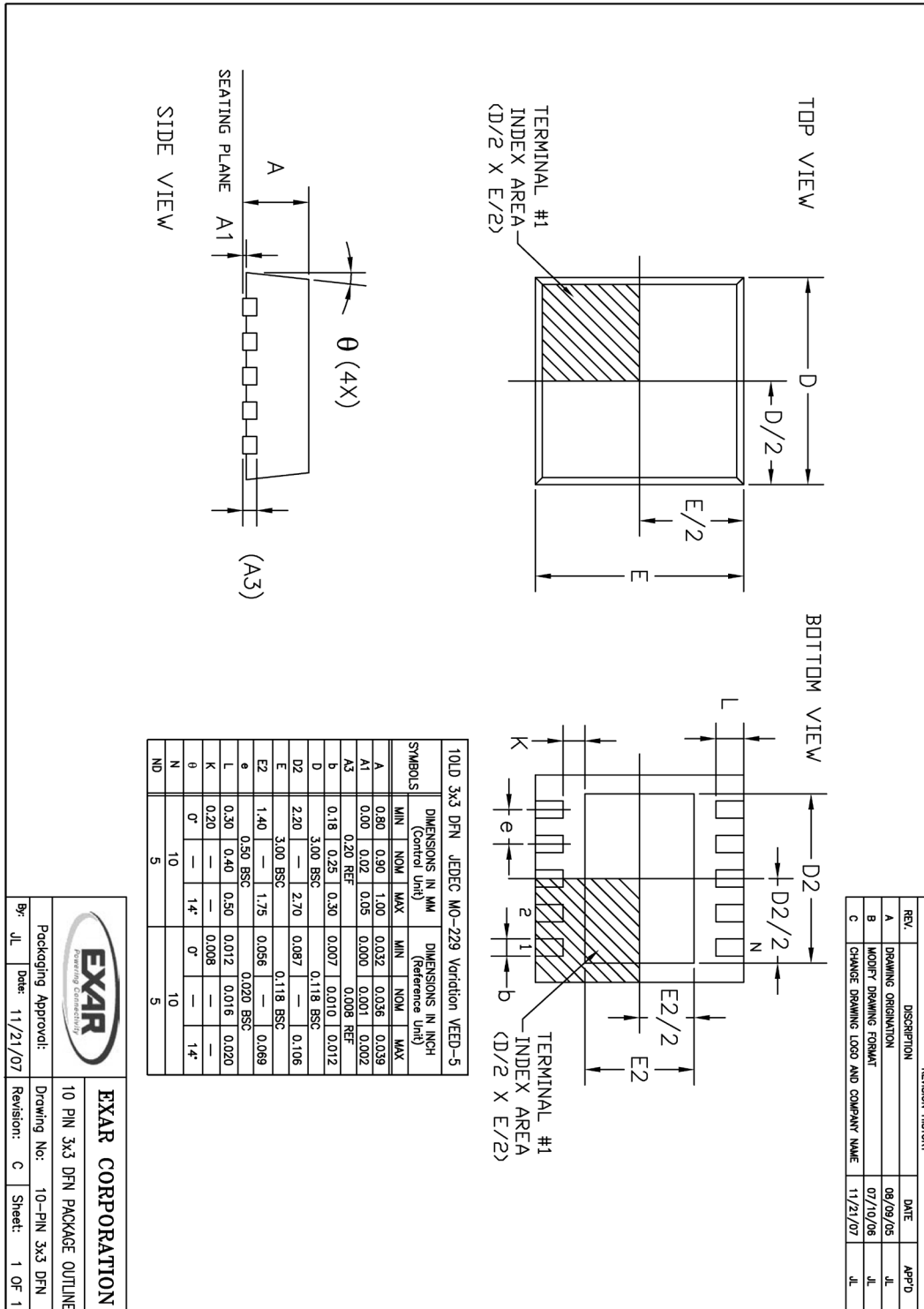

REVISION HISTORY			
REV.	DESCRIPTION	DATE	APP'D.
A	DRAWING ORIENTATION	09/09/05	JL
B	MODIFY DRAWING FORMAT	07/10/06	JL
C	CHANGE DRAWING LOGO AND COMPANY NAME	11/21/07	JL

**EXAR CORPORATION**

10 PIN 3x3 DFN PACKAGE OUTLINE

Packaging Approval: JL Date: 11/21/07

Drawing No: 10-PIN 3x3 DFN

Revision: C Sheet: 1 OF 1



**REVISION HISTORY**

Revision	Date	Description
2.0.0	08/04/2009	Reformat of datasheet. Added EN pin ESD information.
2.0.1	01/24/2020	Updated to MaxLinear logo. Updated Ordering Information.



**CORPORATE HEADQUARTERS:**

5966 La Place Court  
Suite 100  
Carlsbad, CA 92008  
Tel.: +1 (760) 692-0711  
Fax: +1 (760) 444-8598  
[www.maxlinear.com](http://www.maxlinear.com)

The content of this document is furnished for informational use only, is subject to change without notice, and should not be construed as a commitment by Maxlinear, Inc. Maxlinear, Inc. Assumes no responsibility or liability for any errors or inaccuracies that may appear in the informational content contained in this guide. Complying with all applicable copyright laws is the responsibility of the user. Without limiting the rights under copyright, no part of this document may be reproduced into, stored in, or introduced into a retrieval system, or transmitted in any form or by any means (electronic, mechanical, photocopying, recording, or otherwise), or for any purpose, without the express written permission of Maxlinear, Inc.

Maxlinear, Inc. Does not recommend the use of any of its products in life support applications where the failure or malfunction of the product can reasonably be expected to cause failure of the life support system or to significantly affect its safety or effectiveness. Products are not authorized for use in such applications unless Maxlinear, Inc. Receives, in writing, assurances to its satisfaction that: (a) the risk of injury or damage has been minimized; (b) the user assumes all such risks; (c) potential liability of Maxlinear, Inc. Is adequately protected under the circumstances.

Maxlinear, Inc. May have patents, patent applications, trademarks, copyrights, or other intellectual property rights covering subject matter in this document. Except as expressly provided in any written license agreement from Maxlinear, Inc., the furnishing of this document does not give you any license to these patents, trademarks, copyrights, or other intellectual property.

Maxlinear, the Maxlinear logo, and any Maxlinear trademarks, MxL, Full-Spectrum Capture, FSC, G.now, AirPHY and the Maxlinear logo are all on the products sold, are all trademarks of Maxlinear, Inc. or one of Maxlinear's subsidiaries in the U.S.A. and other countries. All rights reserved. Other company trademarks and product names appearing herein are the property of their respective owners.

© 2009 - 2020 Maxlinear, Inc. All rights reserved.