

SF2126E

**725.00 MHz
SAW Filter**

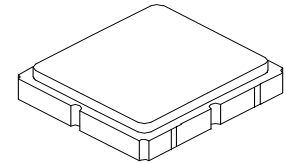

SM3030-8

- **Low-loss SAW Filter for Wimax Application**
- **3.0 x 3.0mm Surface Mount Case**
- **50Ω Input/Output Impedance**
- **Complies with Directive 2002/95/EC (RoHS)**
- **Mositure Sensitivity Level: 1**

Absolute Maximum Ratings

Rating	Value	Units
Input Power Level	+15	dBm
DC Voltage on any Non-ground Terminal	3	V
Operable Temperature Range	-45 to +105	°C
Specification Temperature Range	-40 to +95	°C
Storage Temperature Range in Tape and Reel	-40 to +85	°C
Suitable for Lead-free Soldering - Maximum Soldering Profile	260 °C for 30 s	

Electrical Characteristics

Characteristic	Sym	Notes	Min (-40 to 95°C)	Typ	Max (-30 to 85°C)	Max (-40 to 95°C)	Units
Nominal Center Frequency	f _C			725			MHz
Frequency Range			700			750	MHz
Insertion Loss	IL			2.6	3.0	4.0	dB
Amplitude Ripple, p-p, 700 to 750 MHz				1	1.5	1.8	
VSWR					2.2	2.5	
Attenuation Referenced to 0 dB:							
500 to 600 MHz			40				
601 to 650 MHz			30				
651 to 665 MHz			20				
780 to 824 MHz			15				
825 to 844 MHz			30				
845 to 960 MHz			40				
Source Impedance	Z _S			50			Ω
Load Impedance	Z _L			50			Ω

Case Style	SM3030-8 3.0 x 3.0 mm Nominal Footprint
Lid Symbolization, Y=year, WW=week, S=shift, dot=pin 1 indicator	648, <u>YWW</u> S

Electrical Connections

Connection	Terminals
Port 1	Input
Port 2	Output
	Ground
	All Others

Dot Indicates Pin 1

CAUTION: Electrostatic Sensitive Device. Observe precautions for handling.

NOTES:

1. The design, manufacturing process, and specifications of this device are subject to change.
2. US or International patents may apply.
3. RoHS compliant from the first date of manufacture.

Frequency Characteristics:

15 May 2007 07:31:11

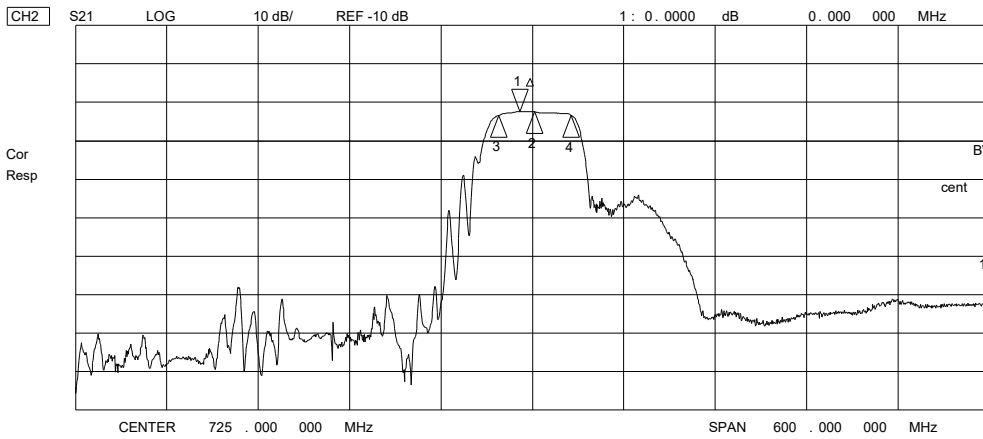
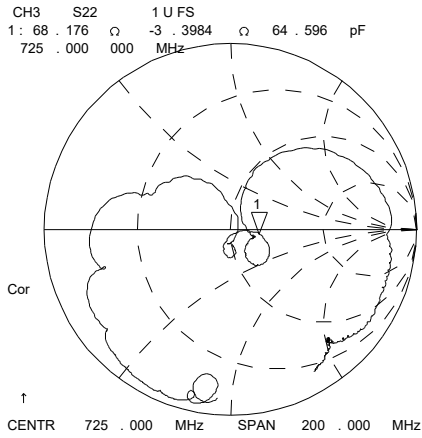
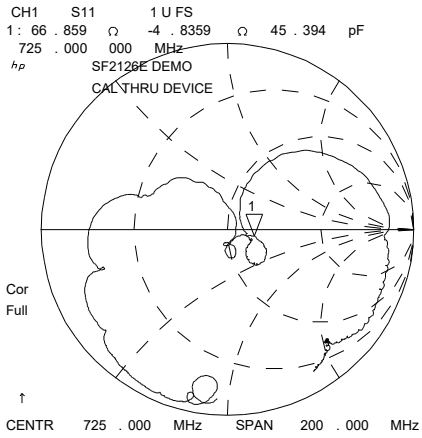

8-Terminal Ceramic Surface-Mount Case 3.0 X 3.0 mm Nominal Footprint

Case and PCB Footprint Dimensions

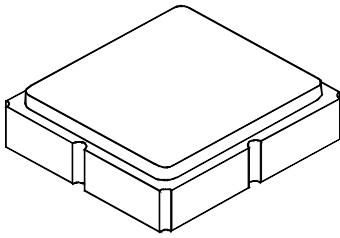

Dimension	mm			Inches		
	Min	Nom	Max	Min	Nom	Max
A	2.87	3.00	3.13	0.113	0.118	0.123
B	2.87	3.00	3.13	0.113	0.118	0.123
C	1.14	1.27	1.40	0.045	0.050	0.055
D	0.79	0.92	1.05	0.031	0.036	0.041
E	0.62	0.75	0.88	0.024	0.029	0.034
F	0.47	0.60	0.73	0.018	0.024	0.029
G	0.47	0.60	0.73	0.018	0.024	0.029
H	1.07	1.20	1.33	0.042	0.047	0.052
I		3.20			0.126	
J		0.90			0.035	
K		0.96			0.038	
L		0.82			0.032	
M		1.39			0.055	
N		0.23			0.009	
O		0.29			0.011	

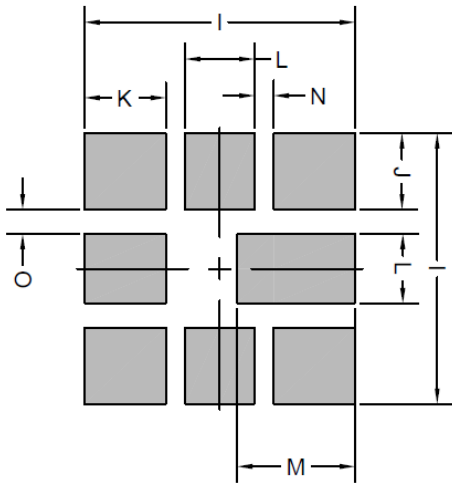

PCB Footprint Top View

Case Materials

Materials	
Solder Pad Plating	0.3 to 1.0 μm Gold over 1.27 to 8.89 μm Nickel
Lid Plating	2.0 to 3.0 μm Nickel
Body	Al_2O_3 Ceramic

TOP VIEW

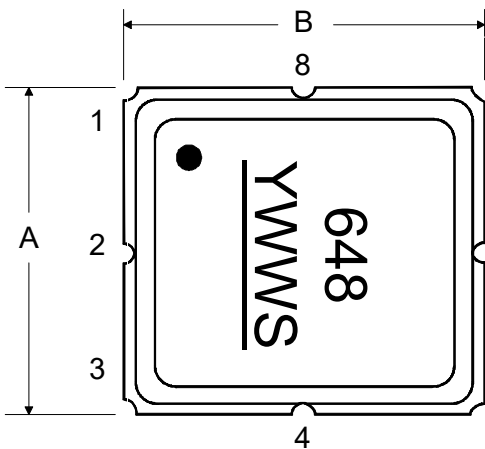

BOTTOM VIEW

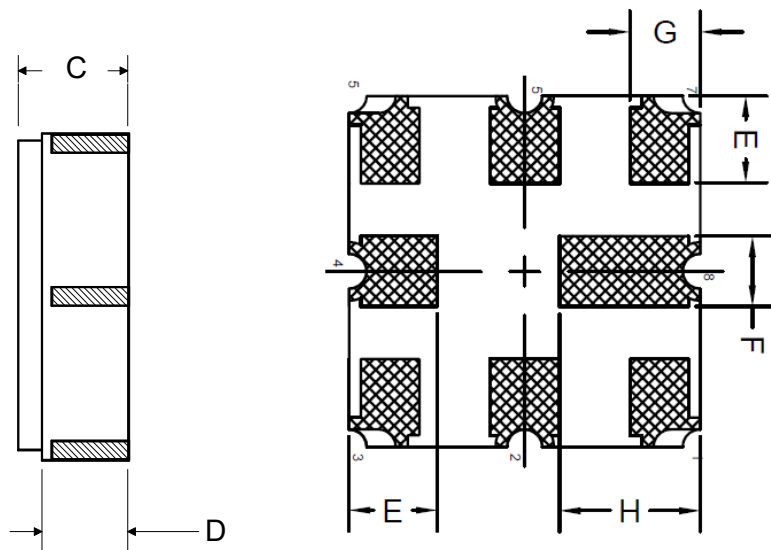

Tape and Reel Specifications

Tape and Reel Standard per ANSI/EIA-481

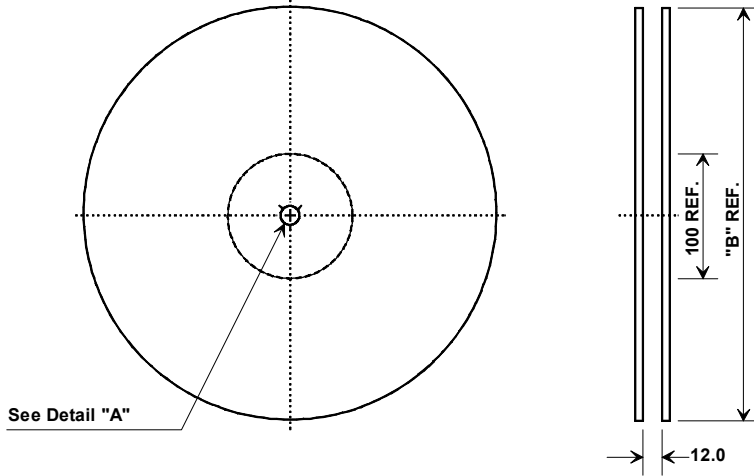

"B"		Quantity Per Reel
Inches	millimeters	
7	178	500
13	330	3000

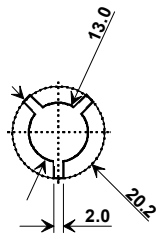

COMPONENT ORIENTATION and DIMENSIONS

Carrier Tape Dimensions	
Ao	3.35 mm
Bo	3.35 mm
Ko	1.40 mm
Pitch	8.0 mm
W	12.0 mm

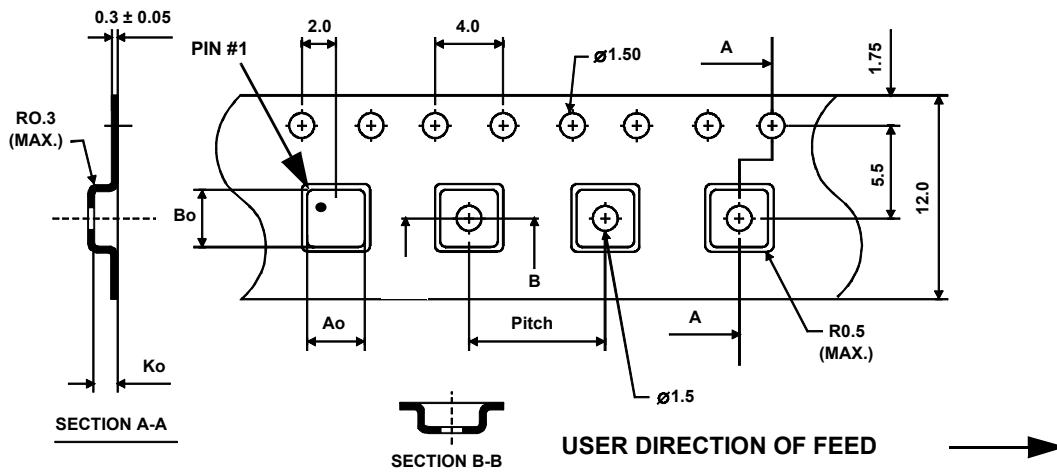

Recommended Reflow Profile

1. Preheating shall be fixed at 150~180°C for 60~90 seconds.
2. Ascending time to preheating temperature 150°C shall be 30 seconds min.
3. Heating shall be fixed at 220°C for 50~80 seconds and at 260°C+0/-5°C peak (10 seconds).
4. Time: 5 times maximum.

