

TMR2623

High Frequency Response Programmable TMR Linear Magnetic Sensor

Description

The TMR2623 is a tunneling magnetoresistance (TMR) linear sensor with a dedicated signal conditioning circuit built in. The integrated signal conditioning circuit of TMR2623 is able to calibrate zero-offset, gain, temperature coefficient of sensitivity (TCS) and temperature coefficient of zero offset (TCO) of the TMR bridge circuit, and outputs the conditioned voltage signals.

In addition to TMR's intrinsic advantages of high resolution, high signal-to-noise ratio, and low power consumption, TMR2623 series linear sensors also provide the following characteristics:

1. Fixed voltage output range in linear range
2. Excellent sensitivity consistency
3. Minimal zero drift
4. Low temperature coefficient of sensitivity
5. Low temperature coefficient of offset

This improvement greatly enhances the convenience of design and use of TMR linear sensor products.

TMR2623 is available in DFN6L (3mm×2mm×0.75mm) package with P/N of TMR2623D.



DFN6L

Features and Benefits

- Tunneling magnetoresistance (TMR) technology
- High frequency response: DC~2 MHz
- Large dynamic range: ± 500 Gs
- Wide range supply voltages: 3 V to 5.5 V
- Nonlinearity: 0.2%
- Programmable sensitivity and zero offset
- Programmable temperature compensation
- RoHS & Reach compliant

Applications

- Current sensor
- Linear position sensor
- Gaussmeter
- Encoder

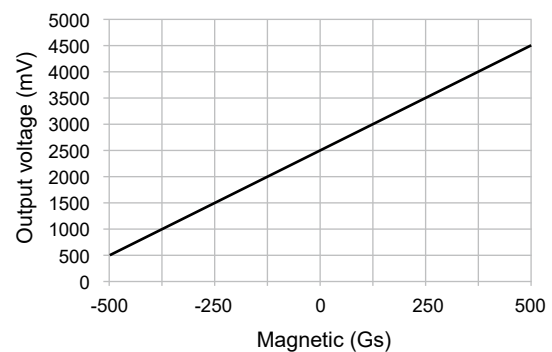

TMR2623D output transfer curve

Selection Guide

Part Number	Supply Voltage(V)	Zero Offset(V)	Reference Voltage(V)	Package	Packing Form
TMR2623D-P5	5	2.5	2.5	DFN6L	Tape & Reel
TMR2623D-P3	3	1.65	1.65	DFN6L	Tape & Reel

Catalogue

1. Functional Block Diagram.....	03
2. Pin Configuration.....	03
3. Sensing Direction.....	03
4. Absolute Maximum Ratings.....	04
5. Electrical Specifications.....	04
6. Typical Characteristics.....	05
7. Application Information.....	06
8. Dimensions.....	07

1. Functional Block Diagram

TMR2623 integrates a linear TMR magnetic sensor and a dedicated signal conditioning chip with a single-ended analog voltage output signal. The V_{OUT} pin can be reused as the OWI(One-Wire-Interface) protocol programming interface, to adjust zero-point, sensitivity, reference voltage V_{REF} and other parameters in a targeted manner.

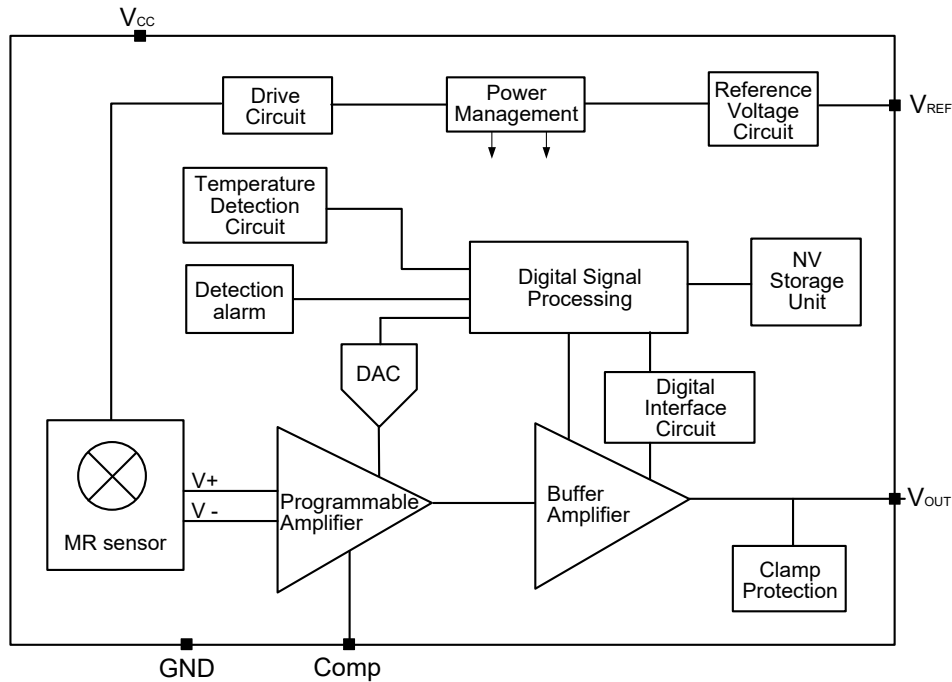

Figure 1. Block Diagram

2. Pin Configuration

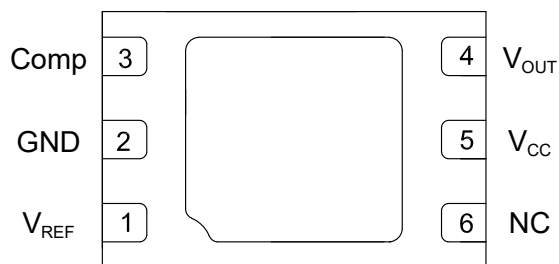

Figure 2. Pin Configuration (DFN6L)

Pin Number	Name	Function
1	V_{REF}	Reference voltage output
2	GND	Ground
3	Comp	Analog voltage
4	V_{OUT}	Analog output
5	V_{CC}	Power supply
6	NC	Not connected
	EP	Center Pad

3. Sensing Direction

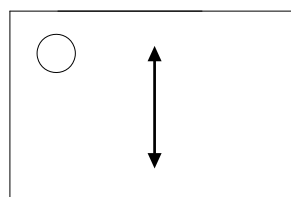

Figure 3. Sensing Direction

4. Absolute Maximum Ratings

Parameters	Symbol	Min.	Max.	Unit
Supply voltage	V_{CC}	3	5.5	V
Supply current	$I_{CC}^{1)}$	-	8	mA
Magnetic flux density	B	-	4000	Gs
ESD performance (HBM)	V_{ESD}	-	4	kV
Operating ambient temperature	T_A	-40	125	°C
Storage ambient temperature	T_{STG}	-50	150	°C

1) Supply current I refers to the current to operate after calibration.

5. Electrical Specifications

Parameter	Symbol	Condition	Min.	Typ.	Max.	Unit	Applicable Part Number
Supply voltage	V_{CC}	$T_A=25^\circ\text{C}$	3	5	5.5	V	TMR2623D-P5
			3	3.3	5.5	V	TMR2623D-P3
Supply current	I_{CC}	$V_{CC}=5\text{V}, T_A=25^\circ\text{C}$	-	5	8	mA	TMR2623D-P5
		$V_{CC}=3.3\text{V}, T_A=25^\circ\text{C}$	-	5	8	mA	TMR2623D-P3
Power-on time	T_{PO}	$T_A=25^\circ\text{C}$	-	40	-	ms	All parts
Magnetic range	H_{SAT}	$T_A=25^\circ\text{C}$	-500	-	500	Gs	
Sensitivity	$SEN^{2)}$	$V_{CC}=5\text{V}, T_A=25^\circ\text{C}$	2	-	100	mV/Gs	TMR2623D-P5
		$V_{CC}=3.3\text{V}, T_A=25^\circ\text{C}$	1	-	65	mV/Gs	TMR2623D-P3
Zero offset	V_{OFFSET}	$V_{CC}=5\text{V}, T_A=25^\circ\text{C}$	-	2.5	-	V	TMR2623D-P5
		$V_{CC}=3.3\text{V}, T_A=25^\circ\text{C}$	-	1.65	-	V	TMR2623D-P3
Reference voltage	V_{REF}	$V_{CC}=5\text{V}, T_A=25^\circ\text{C}$	-	2.5	-	V	TMR2623D-P5
		$V_{CC}=3.3\text{V}, T_A=25^\circ\text{C}$	-	1.65	-	V	TMR2623D-P3
		V_{CC}	-	$V_{CC}/2$	-	V	TMR2623D-P3
Hysteresis	HYS	$T_A=25^\circ\text{C}, +/-100\text{Gs}$	-	0.1	-	Gs	All parts
		$T_A=25^\circ\text{C}, +/-500\text{Gs}$	-	0.5	-	Gs	
Nonlinearity	NONL	$T_A=25^\circ\text{C}$	-	0.2	-	%FS	
Temperature coefficient of sensitivity	TCS ³⁾	-40°C to 125°C	-	-	100	PPM/°C	
Temperature coefficient of offset	TCO ⁴⁾	-40°C to 125°C	-	-	50	PPM/°C	
Response frequency	F	Minimum gain	DC~2MHz				

2) The typical value of sensitivity is programmable via OWI protocol.

3) The TCS is programmable through OWI protocol for multi-point temperature calibration to obtain better results.

4) The TCO is programmable through OWI protocol for multi-point temperature calibration to obtain better results.

6. Typical Characteristics

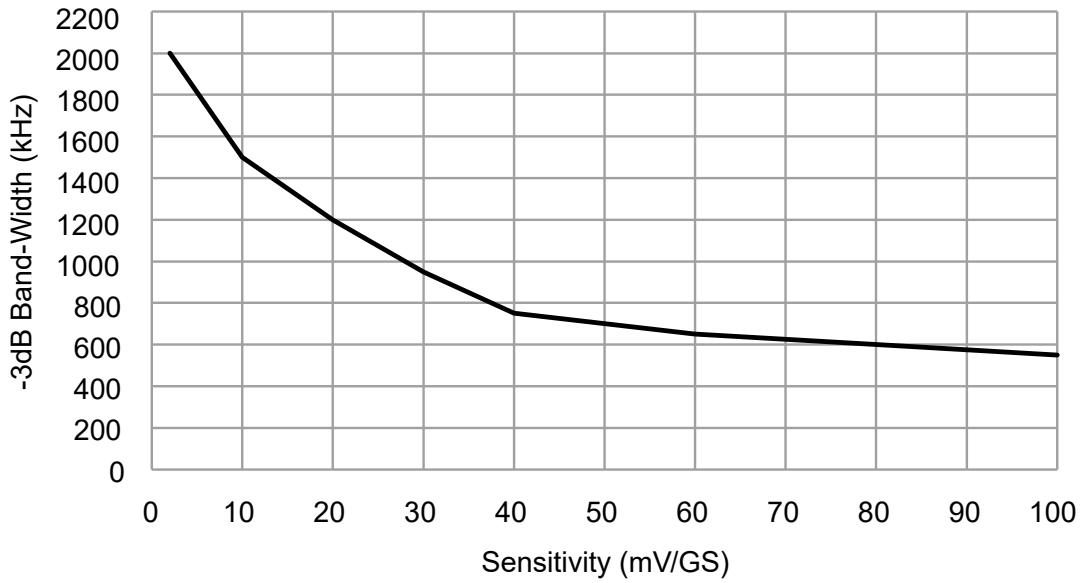
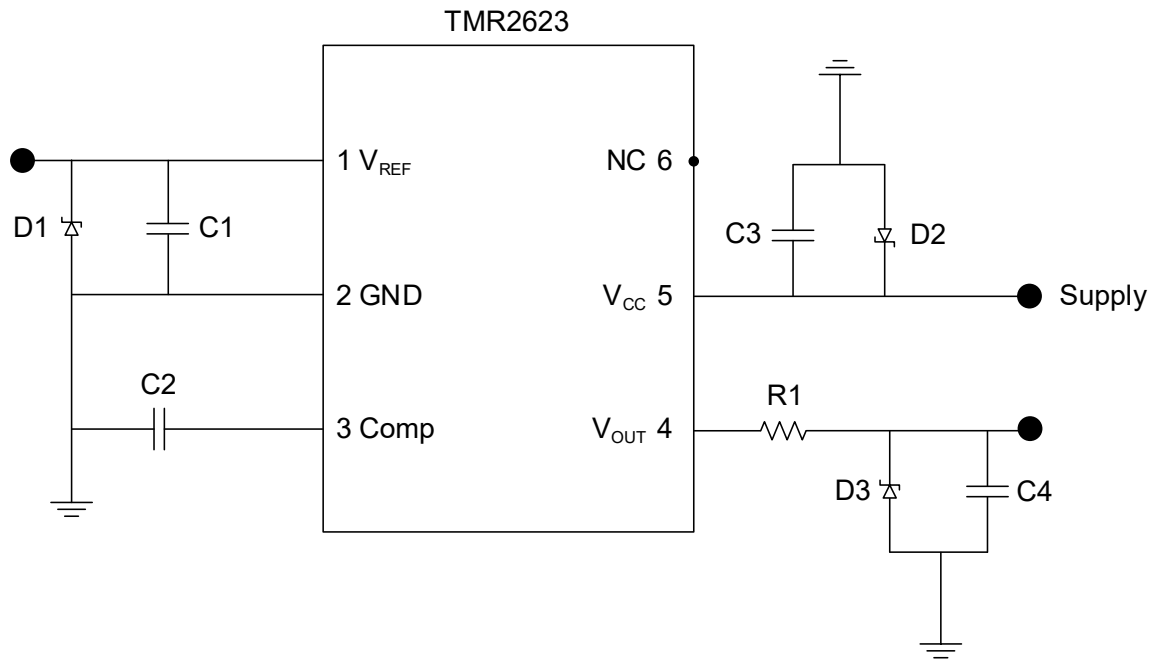

Figure 4. Sensitivity VS Band-width

7. Application Information



Device description in Figure 5:

R1		R1/C4: for output pin RC filtering
C1	20pF	Connects V_{REF} to GND for reference voltage filtering
C2	20pF	Connects Comp to GND for output voltage filtering
C3	0.1 μ F	Connects V_{CC} to GND for supply voltage filtering
C4		R1/C4: for output pin RC filtering
D1	ESD5341N_5V/NA	Dual lead bidirectional 5V transient voltage suppression devices for ESD/surge protection
D2	ESD5341N_5V/NA	Dual lead bidirectional 5V transient voltage suppression devices for ESD/surge protection
D3	ESD5341N_5V/NA	Dual lead bidirectional 5V transient voltage suppression devices for ESD/surge protection

Figure 5. Typical Application Circuit

Please contact MDT regional sales representative to obtain "Product Application Manual" for more information about TMR2623 product application, including programming methods (OWI programming instructions) for sensor sensitivity, temperature coefficient of sensitivity, zero offset, temperature coefficient of zero offset, nonlinearity, etc.

8. Dimensions

DFN6L Package

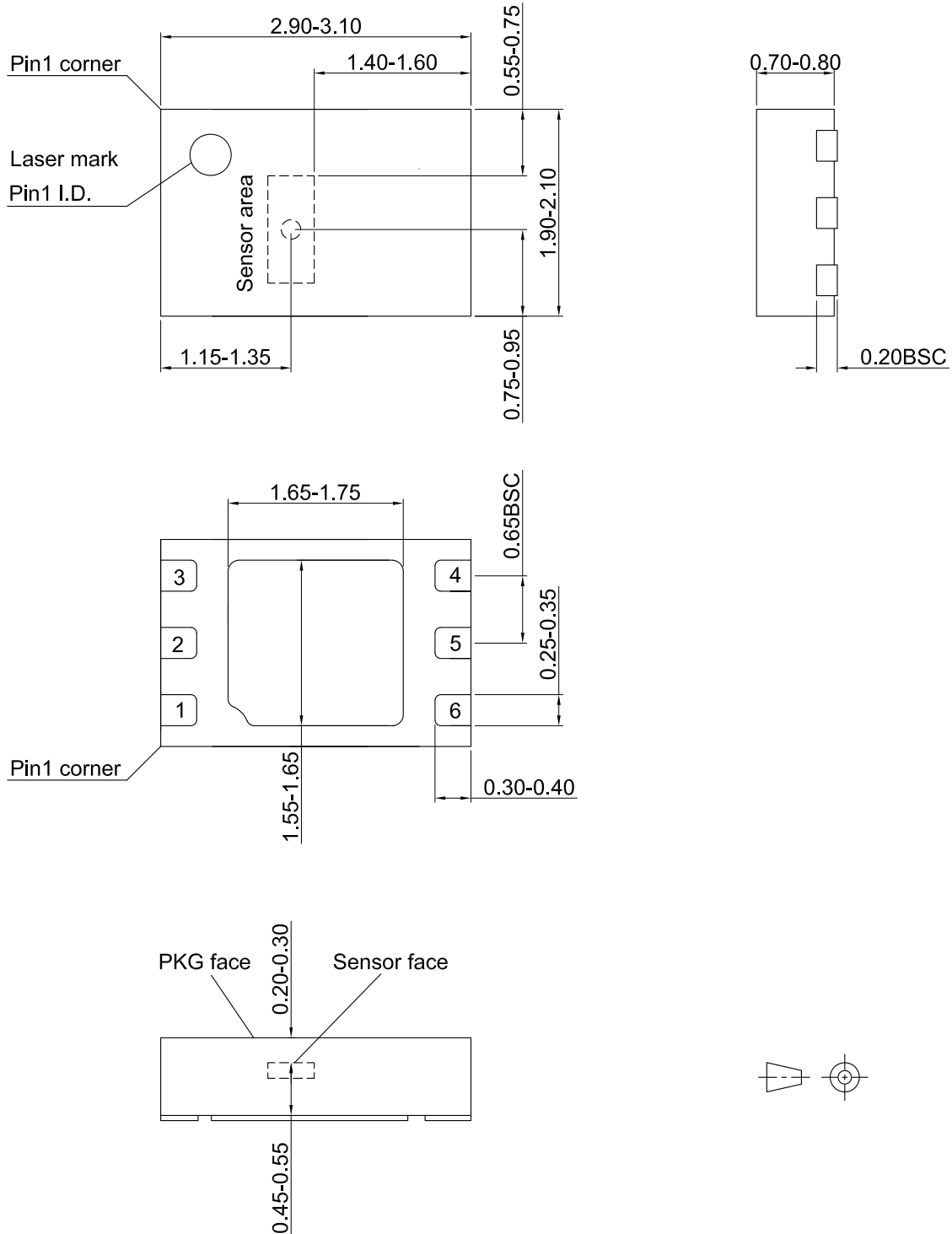

Figure 6. Package outline of DFN6L (unit: mm)

Copyright © 2022 by MultiDimension Technology Co., Ltd.

Information furnished herein by MultiDimension Technology Co., Ltd. (hereinafter MDT) is believed to be accurate and reliable. However, MDT disclaims any and all warranties and liabilities of any kind, with respect to any examples, hints or any performance or use of technical data as described herein and/or any information regarding the application of the product, including without limitation warranties of non-infringement of intellectual property rights of any third party. This document neither conveys nor implies any license under patent or other industrial or intellectual property rights. Customer or any third-party must further determine the suitability of the MDT products for its applications to avoid the applications default of customer or third-party. MDT accept no liability in this respect.

MDT does not assume any liabilities of any indirect, incidental, punitive, special or consequential damages (including without limitation of lost profits, lost savings, business interruption, costs related to the removal or replacement of any products or rework charges) whether or not such damages are based on tort (including negligence), warranty, breach of contract or any other legal theory. Notwithstanding any damages that customer might incur for any reason whatsoever, MDT's aggregate and cumulative liability towards customer for the products described herein shall be limited in accordance with the terms and conditions of commercial sale of MDT.

Absolute maximum ratings are the extreme limits the device will withstand without damage to the MDT product. However, the electrical and mechanical characteristics are not guaranteed as the maximum limits (above recommended operating conditions) are approached. MDT disclaims any and all warranties and liabilities of the MDT product will operate at absolute maximum ratings.

Specifications may change without notice.

Please download latest document from our official website www.dowaytech.com/en.

Recycling

The product(s) in this document need to be handed over to a qualified solid waste management services company for recycling in accordance with relevant regulations on waste classification after the end of the product(s) life.



No.2 Guangdong Road, Zhangjiagang Free Trade Zone, Jiangsu, China

Web: www.dowaytech.com/en E-mail: info@dowaytech.com

