

Electrode Holder PS-□S(R)/-31

CSM_PS-S(R)-31_DS_E_7_5

Separate Electrode Holders for Water Supply and Drainage Control in Buildings. Small, Lightweight Electrode Holders for Use as Built-in Components.

- The PS-□S(R) are separate Electrode Holders that allow the Electrodes to be withdrawn easily for inspection.
- The PS-□S(R) come in 3, 4, or 5 pole models for supply and drainage of tap water in buildings.
- PS-31 is a small and light-weight Electrode Holder that is suitable for installation in limited space and built-in components.



⚠ Refer to Safety Precautions for Electrodes and Electrode Holders.

Ordering Information

■ Electrode Holders

Application	Model
General applications for purified water	
For 3-pole electrode	PS-3S
For 3-pole electrode (2-wire)	PS-3SR
For 4-pole electrode	PS-4S
For 4-pole electrode (2-wire)	PS-4SR
For 5-pole electrode	PS-5S
For 5-pole electrode (2-wire)	PS-5SR
For small spaces (3-pole)	PS-31 (SUS304, 300 mm) PS-31 (SUS304, 1,000 mm)

■ Accessories (Order Separately)

Application	Model
Protective Cover (for PS-□S and BF-3/-5)	F03-11
Mounting Frame (for PS-□S)	F03-12
Mounting Frame for Installing in Concrete (for PS-□S(R))	F03-13
Dust-proof Rubber Cap (for PS-31)	F03-31

Specifications

Item	Model	PS-3S(R) (See note 1.)	PS-4S(R) (See note 1.)	PS-5S(R) (See note 1.)	PS-31 (See note 2.)
No. of Electrodes		3	4	5	3 (See note 3.)
Material		Resin (PBT = Polybutylene terephthalate)			
Insulation resistance		100 MΩ min.			
Operating temperature		-10 to 70°C (with no icing)			
Operating pressure		Atmospheric pressure			
Applications		Water supply and drainage control in buildings			Limited Mounting Space
Electrodes		Purchase F03-01 separately.			Single-piece construction

- Note:**
1. The Two-wire Electrode Holders (R models) have a built-in resistor of 6.8 kΩ. They should be used with the Two-wire 61F Controllers.
 2. Cut the electrodes to the desired length.
 3. PS-31 comes in a 3-pole model only.

■ PS-□S(R) Electrode Holder Accessories (Order Separately)

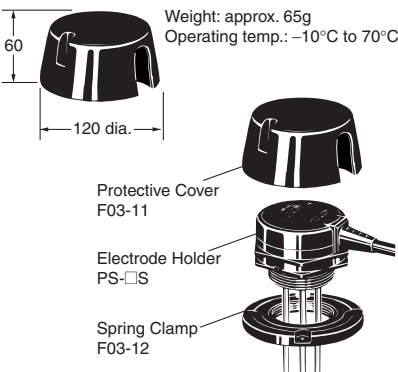
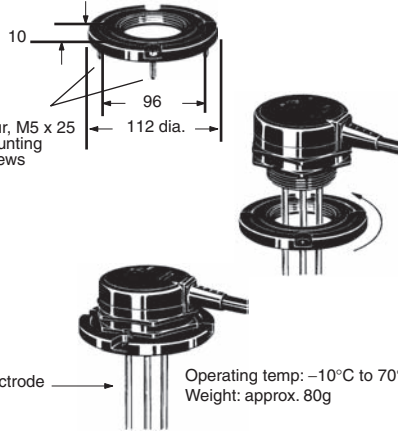
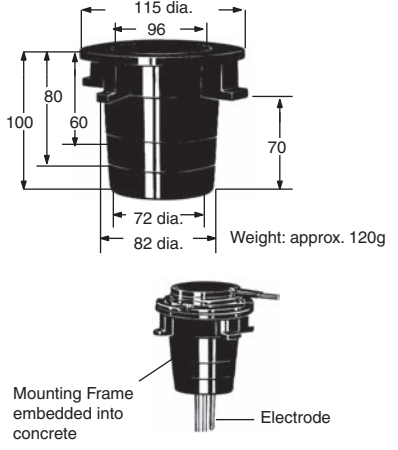
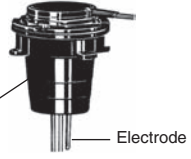
F03-11 Protective Cover	F03-12 Spring Clamp	F03-13 Mounting Frame for installing in concrete
<p>Use this Cover for PS-series Electrode Holders with Mounting Frames (upper one in the following illustration), This Cover can also be used when installing the BF-series Electrode Holders outdoors. This Cover is for protection from rain and wind. It is not waterproof.</p> <p>Applicable Electrode Holders: BF-3, BF-4, BF-5, PS-3S(R), PS-4S(R), PS-5S(R)</p>  <p>Weight: approx. 65g Operating temp.: -10°C to 70°C</p> <p>Protective Cover F03-11 Electrode Holder PS-□S Spring Clamp F03-12</p>	<p>Used to clamp an Electrode Holder with ease, as shown in the illustrations, when the Electrode Holder is applied to a tank without a coupling.</p> <p>Squeeze the mounting frame into the Holder as shown below.</p> <p>Applicable Electrode Holders: PS-3S(R), PS-4S(R), PS-5S</p>  <p>Four, M5 x 25 mounting screws</p> <p>Electrode</p> <p>Operating temp: -10°C to 70°C Weight: approx. 80g</p>	<p>Firmly secure the F03-12 Spring Clamp to the F03-13 Mounting Frame with M5 x 25 screws and embed it into the concrete production water tank. Cut the F03-13 to match the depth of the concrete.</p>  <p>Weight: approx. 120g</p>  <p>Mounting Frame embedded into concrete</p> <p>Electrode</p> <p>Commonly used with Mounting Frame</p>

Note: If the F03-11 and F03-12 are used together, the screws and bolts that are provided with the F03-11 cannot be used.

■ PS-31 Electrode Holder Accessories (Order Separately)

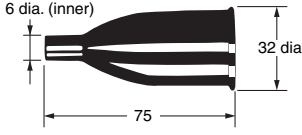
F03-31 Dust-proof Rubber Bushing
<p>Note: This Bushing is not waterproof.</p>  <p>Material: Silicon rubber</p>

■ Accessories Required for Connecting the PS-□S(R) and Electrodes (Order Separately)

Electrodes Shorter than 1 m

The following items are required for each pole.

- 1 × F03-01 Electrode
- 1 × F03-03 Lock Nut

The Electrode can be cut anywhere based on the control level.

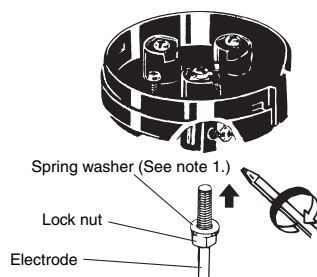

Electrode Longer than 1 m

The following items are required for every additional meter of electrode for each pole.

- 1 × F03-01 Electrode
- 1 × F03-02 Connecting Nut
- 2 × F03-03 Lock Nuts

Use F03-14 1P, 3P, and 5P Separators to prevent the electrodes from touching each another.

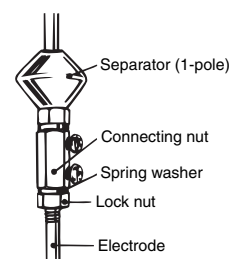

Note: 1. The spring washer comes with the lock nut.

2. Refer to F03-□ for details on Electrodes, Connecting Nuts, Lock Nuts, and Separators.

Mounting

■ PS-3S Electrode Holders

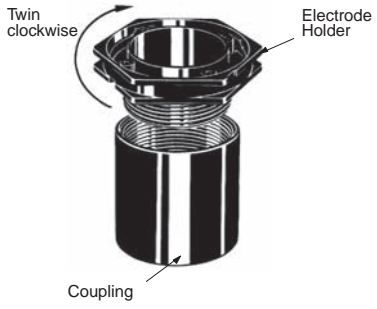
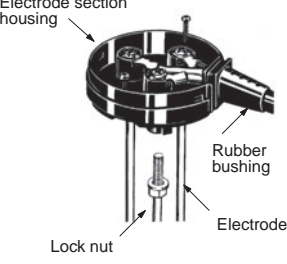
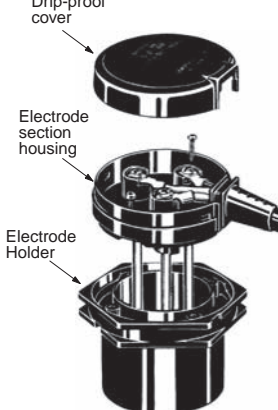
1. Mounting Electrode Holder	2. Attaching Electrode(s) to Electrode section	3. Inserting Electrode section into Electrode Holder
<ul style="list-style-type: none"> Screw the Electrode Holder into the coupling secured at the installation location. 	<ul style="list-style-type: none"> Insert each Electrode into the connecting nut, secure the Electrode with the clamp screws, and then tighten the lock nut. Connect the leads, inserted through the hole of the rubber bushing, into the respective terminals. 	<ul style="list-style-type: none"> Fit the Electrode section into the Electrode Holder and secure it with the two screws. Check the Electrode section for proper wiring, fit the rubber bushing in position, and then cover the Electrode Holder with the drip-proof cover.
 <p>Twin clockwise</p> <p>Electrode Holder</p> <p>Coupling</p>	 <p>Electrode section housing</p> <p>Lock nut</p> <p>Rubber bushing</p> <p>Electrode</p>	 <p>Drip-proof cover</p> <p>Electrode section housing</p> <p>Electrode Holder</p>

Note: 1. OMRON does not sell couplings.

2. Screw in the Electrode until it reaches the bottom of the nut. Insufficient insertion will cause a faulty connection.

Dimensions

Note: All units are in millimeters unless otherwise indicated.

Electrode Holders

PS-3S/-4S/-5S
PS-3SR/-4SR/-5SR
(see note)

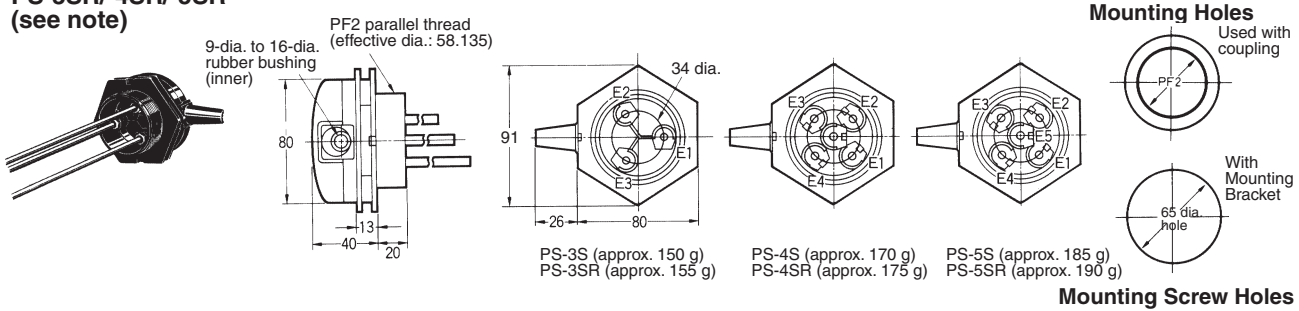

Note: The PS-3SR, PS-4SR, and PS-5SR have built-in resistor of 6.8 kΩ and used for the two-wire 61F models.

PS-31

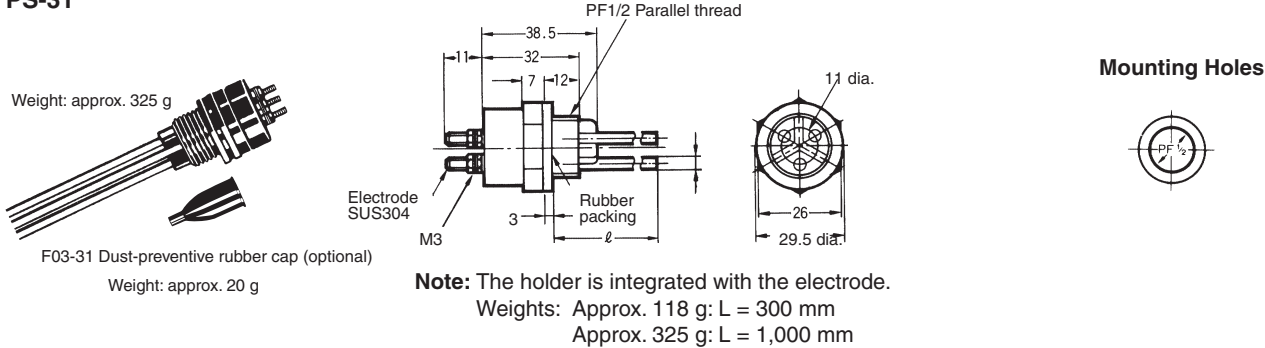

Safety Precautions

Refer to *Safety Precautions for All Level Controllers*.

ALL DIMENSIONS SHOWN ARE IN MILLIMETERS.
To convert millimeters into inches, multiply by 0.03937. To convert grams into ounces, multiply by 0.03527.

In the interest of product improvement, specifications are subject to change without notice.

Level Controller Installation

■ Attaching Electrodes to the Electrode Holder

Appearance

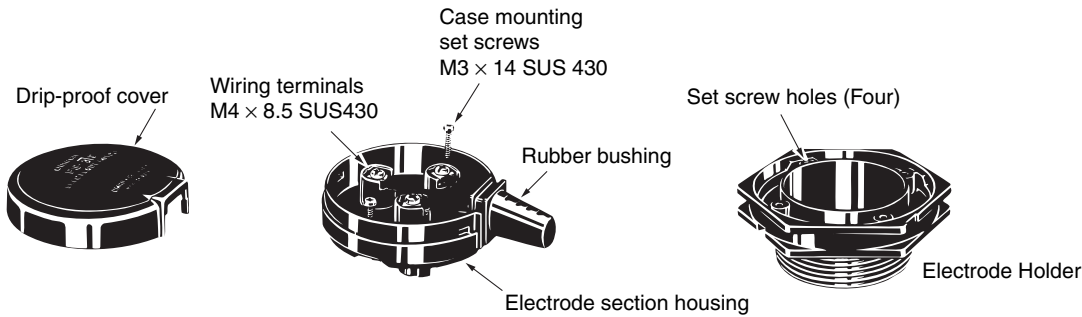

1. Removing the cover

1. Wedge a flat-blade screwdriver into the groove on either side of the rubber bushing and lever it off alternately. (The cover may break if you lever it too much on one side.)

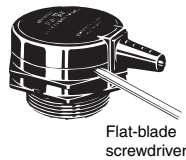

2. Undo the two set screws and lift off the electrode section.

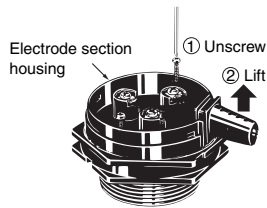

2. Mounting

1. Screw the Electrode Holder into the coupling (54 dia.) secured at the installation location.

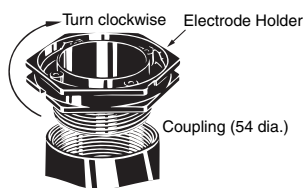

2. Screw in the electrodes until it cannot be turned any further, tighten the lock nut, and then secure them with the clamp screws (M3.5).

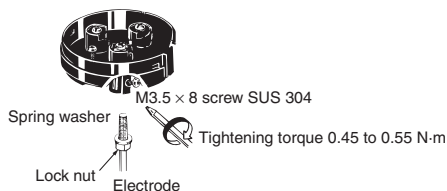

3. Attach the electrode section to the Electrode Holder.

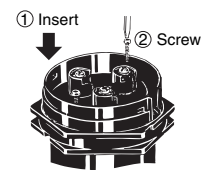

(Secure with the two case mounting screws. Tightening torque 0.7 N·m)

4. The rubber bushing can be cut with a utility knife if the hole size requires adjustment to fit the cables.



5. Connect the leads to the respective terminals. (Fit the rubber bushing in position as shown in the diagram below.)

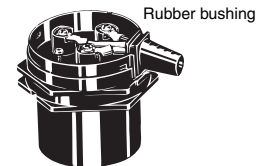

6. Put the claw at the back of the cover into the hole at the back of the electrode section housing and push it close until you hear a click.



■ Installing an Electrode Holder on a Tank

Note: Electrode Holders should always be installed from above the tank.

Method 1

Fabricate screw threads of the same size as PF2 in the tank.

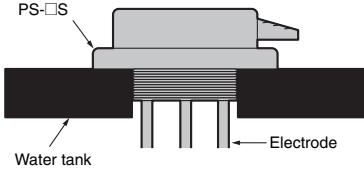

Method 2

Use a commercially available coupling (PF2 parallel thread (effective dia.: 58.135) JIS B0202).

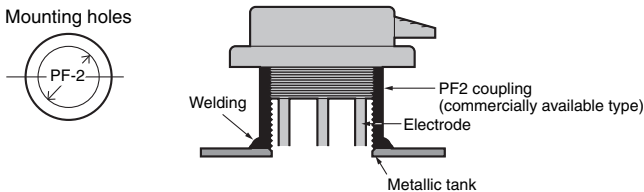

Method 3

Drill a hole (65 dia.) in the tank and insert the Electrode Holder. Use an F03-12 Frame (sold separately) as a nut from below and secure in place.

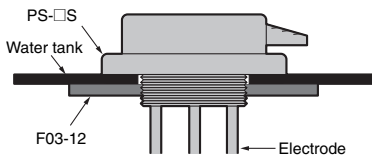

Method 4

Use the F03-12 Frame (sold separately) as a flange.

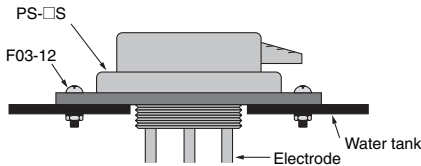

1. Drill a hole in the tank.
2. Attach the Frame over the hole. (Tighten the four F03-12 mounting screws.)

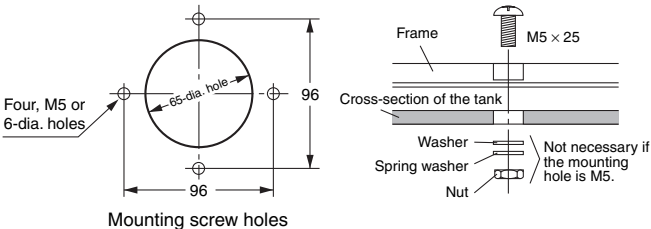

Method 5

Use F03-12 and F03-13 Frames (both sold separately) together and embed them in the concrete.

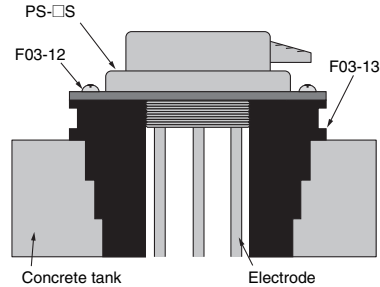

■ Mounting the F03-11 Protective Cover (Sold Separately)

The protective cover can only be used for methods 4 and 5 described in the previous section.

PS-□S(R) Series

Attach the F03-12 Frame to the bottom of the PS-series Electrode Holder. (See diagram below.)

Next, place the F03-11 Protective Cover on top of the Electrode Holder and press on it until it clicks into place.

Note: The cap screw attached to the protective cover is not required for mounting.

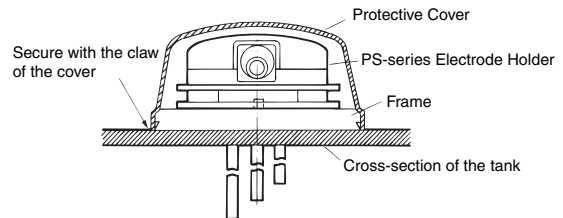

BF-series Electrode Holder (Applicable to BF-3(R), -5(R))

Remove the two mounting screws (M5 × 25) of the BF-series Electrode Holder and attach the two cap screws (M5 × 25) provided with the F03-11 Protective Cover.

Next, put the Protective Cover over the top of the BF-series Electrode Holder, and then tighten the two enclosed screws (M3 × 20 with washers). See diagram below.

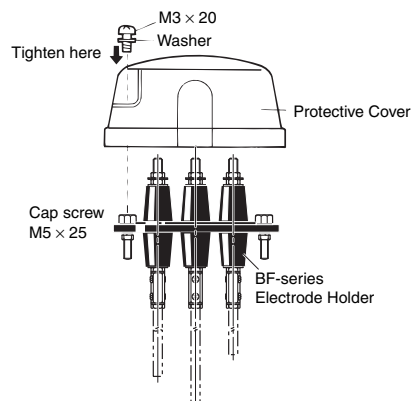

Note: The Protective Cover cannot be mounted on the BF-1.

Terms and Conditions Agreement

Read and understand this catalog.

Please read and understand this catalog before purchasing the products. Please consult your OMRON representative if you have any questions or comments.

Warranties.

(a) Exclusive Warranty. Omron's exclusive warranty is that the Products will be free from defects in materials and workmanship for a period of twelve months from the date of sale by Omron (or such other period expressed in writing by Omron). Omron disclaims all other warranties, express or implied.

(b) Limitations. OMRON MAKES NO WARRANTY OR REPRESENTATION, EXPRESS OR IMPLIED, ABOUT NON-INFRINGEMENT, MERCHANTABILITY OR FITNESS FOR A PARTICULAR PURPOSE OF THE PRODUCTS. BUYER ACKNOWLEDGES THAT IT ALONE HAS DETERMINED THAT THE PRODUCTS WILL SUITABLY MEET THE REQUIREMENTS OF THEIR INTENDED USE.

Omron further disclaims all warranties and responsibility of any type for claims or expenses based on infringement by the Products or otherwise of any intellectual property right. (c) Buyer Remedy. Omron's sole obligation hereunder shall be, at Omron's election, to (i) replace (in the form originally shipped with Buyer responsible for labor charges for removal or replacement thereof) the non-complying Product, (ii) repair the non-complying Product, or (iii) repay or credit Buyer an amount equal to the purchase price of the non-complying Product; provided that in no event shall Omron be responsible for warranty, repair, indemnity or any other claims or expenses regarding the Products unless Omron's analysis confirms that the Products were properly handled, stored, installed and maintained and not subject to contamination, abuse, misuse or inappropriate modification. Return of any Products by Buyer must be approved in writing by Omron before shipment. Omron Companies shall not be liable for the suitability or unsuitability or the results from the use of Products in combination with any electrical or electronic components, circuits, system assemblies or any other materials or substances or environments. Any advice, recommendations or information given orally or in writing, are not to be construed as an amendment or addition to the above warranty.

See <http://www.omron.com/global/> or contact your Omron representative for published information.

Limitation on Liability: Etc.

OMRON COMPANIES SHALL NOT BE LIABLE FOR SPECIAL, INDIRECT, INCIDENTAL, OR CONSEQUENTIAL DAMAGES, LOSS OF PROFITS OR PRODUCTION OR COMMERCIAL LOSS IN ANY WAY CONNECTED WITH THE PRODUCTS, WHETHER SUCH CLAIM IS BASED IN CONTRACT, WARRANTY, NEGLIGENCE OR STRICT LIABILITY.

Further, in no event shall liability of Omron Companies exceed the individual price of the Product on which liability is asserted.

Suitability of Use.

Omron Companies shall not be responsible for conformity with any standards, codes or regulations which apply to the combination of the Product in the Buyer's application or use of the Product. At Buyer's request, Omron will provide applicable third party certification documents identifying ratings and limitations of use which apply to the Product. This information by itself is not sufficient for a complete determination of the suitability of the Product in combination with the end product, machine, system, or other application or use. Buyer shall be solely responsible for determining appropriateness of the particular Product with respect to Buyer's application, product or system. Buyer shall take application responsibility in all cases.

NEVER USE THE PRODUCT FOR AN APPLICATION INVOLVING SERIOUS RISK TO LIFE OR PROPERTY OR IN LARGE QUANTITIES WITHOUT ENSURING THAT THE SYSTEM AS A WHOLE HAS BEEN DESIGNED TO ADDRESS THE RISKS, AND THAT THE OMRON PRODUCT(S) IS PROPERLY RATED AND INSTALLED FOR THE INTENDED USE WITHIN THE OVERALL EQUIPMENT OR SYSTEM.

Programmable Products.

Omron Companies shall not be responsible for the user's programming of a programmable Product, or any consequence thereof.

Performance Data.

Data presented in Omron Company websites, catalogs and other materials is provided as a guide for the user in determining suitability and does not constitute a warranty. It may represent the result of Omron's test conditions, and the user must correlate it to actual application requirements. Actual performance is subject to the Omron's Warranty and Limitations of Liability.

Change in Specifications.

Product specifications and accessories may be changed at any time based on improvements and other reasons. It is our practice to change part numbers when published ratings or features are changed, or when significant construction changes are made. However, some specifications of the Product may be changed without any notice. When in doubt, special part numbers may be assigned to fix or establish key specifications for your application. Please consult with your Omron's representative at any time to confirm actual specifications of purchased Product.

Errors and Omissions.

Information presented by Omron Companies has been checked and is believed to be accurate; however, no responsibility is assumed for clerical, typographical or proofreading errors or omissions.

2022.11

In the interest of product improvement, specifications are subject to change without notice.

OMRON Corporation
Industrial Automation Company

<http://www.ia.omron.com/>

(c)Copyright OMRON Corporation 2022 All Right Reserved.