

## Distance-settable Photoelectric Sensor E3AS-L Series

### Background suppression sensor for enhanced detection low-reflectivity objects



- Equipped with Omron's proprietary light emitting element for stable detection of low-reflective workpieces
  - Teaching method allows anyone to set optimal threshold values
  - Manufactured using Omron's proprietary laser sealing method (IP67/IP69K/IP67G \*)
  - Antifouling coating prevents contamination on the sensing surface
  - IO-Link reduced time required for startups and changeovers
- \* Only for sensor units.



Refer to *Safety Precautions* on page 8.

For the most recent information on models that have been certified for safety standards, refer to your Omron website.

## Ordering Information

### Sensors [Refer to *Dimensions* on page 9.]

Red light

Connection method	Sensing distance (white paper)	Model			
		Output	NPN output	PNP output	PNP output
		IO-Link baud rate	---	COM2 (38.4 kbps)	COM3 (230.4 kbps)
Pre-wired (2 m) <sup>1</sup>			E3AS-L200MN 2M	E3AS-L200MD 2M	E3AS-L200MT 2M
M8 Connector			E3AS-L200MN M3	E3AS-L200MD M3	E3AS-L200MT M3
M8 Pre-wired Connector			E3AS-L200MN-M3J 0.3M	E3AS-L200MD-M3J 0.3M	E3AS-L200MT-M3J 0.3M
M12 Pre-wired Connector <sup>2</sup>			E3AS-L200MN-M1TJ 0.3M	E3AS-L200MD-M1TJ 0.3M	E3AS-L200MT-M1TJ 0.3M
Pre-wired (2 m) <sup>1</sup>			E3AS-L80MN 2M	E3AS-L80MD 2M	E3AS-L80MT 2M
M8 Connector			E3AS-L80MN M3	E3AS-L80MD M3	E3AS-L80MT M3
M8 Pre-wired Connector			E3AS-L80MN-M3J 0.3M	E3AS-L80MD-M3J 0.3M	E3AS-L80MT-M3J 0.3M
M12 Pre-wired Connector <sup>2</sup>			E3AS-L80MN-M1TJ 0.3M	E3AS-L80MD-M1TJ 0.3M	E3AS-L80MT-M1TJ 0.3M

1. Models with 5-m cable length are also available with "5M" suffix. (Example: E3AS-L200MN 5M)
2. The Pre-wired Connector (M12) is Smartclick Connector.

## E3AS-L Series



### Accessories (Sold Separately)

#### Sensor I/O Connectors (Sockets on One Cable End)

(Models for Connectors / Pre-wired Connectors)



A Sensor I/O Connector is not provided with the Sensor. Order separately as needed.

#### Round Water-resistant Connectors XS3F-M8 series

Appearance	Cable specification	Cable diameter (mm)	No. of cable cores (Poles)	Cable connection direction	Cable length (m)	Sensor I/O Connector model number
M8 Connector Straight type  Right-angle type 	PVC cable	5 dia.	4	Straight	2	XS3F-M8PVC4S2M
					5	XS3F-M8PVC4S5M
				Right-angle	2	XS3F-M8PVC4A2M
					5	XS3F-M8PVC4A5M

- Note:** 1. The XS3W (Socket and Plug on Cable Ends) is also available. Refer to *XS3W-M8/XS3F-M8 Series Datasheet* (Cat. No. G140).  
 2. The connectors will not rotate after they are connected.  
 3. The cable is fixed at an angle of 180° from the sensor emitter/receiver surface.







#### Round Water-resistant Connectors XS5 series

Appearance	Cable specification	Cable diameter (mm)	Cable connection direction	Cable length (m)	Sensor I/O Connector model number
M12 Smartclick Connector Straight type  Right-angle type 	PVC robot cable	6 dia.	Straight	2	XS5F-D421-D80-F
				5	XS5F-D421-G80-F
			Right-angle	2	XS5F-D422-D80-F
				5	XS5F-D422-G80-F

- Note:** 1. The XS5W (Socket and Plug on Cable Ends) is also available. Refer to *XS5* on your Omron website for details.  
 2. The connectors will not rotate after they are connected.  
 3. The cable is fixed at an angle of 180° from the sensor emitter/receiver surface.

## Mounting Brackets [Refer to *Dimensions* on page 10.]

A Mounting Bracket is not enclosed with the Sensor. Order separately as needed.

Appearance	Model (material)	Applicable Sensor E3AS series			
		Pre-wired	M8 Pre-wired Connector	M12 Pre-wired Smartclick Connector	M8 Connector
<b>L-shaped Mounting Bracket</b> 	E39-L201 (SUS304)	Yes	Yes	Yes	---
<b>Horizontal Protective Cover Bracket</b> 	E39-L202 (SUS304)	Yes	Yes	Yes	---
<b>Rear Mounting Bracket</b> 	E39-L203 (SUS304)	Yes	Yes	Yes	Yes <sup>2</sup>
<b>Robust Mounting Bracket</b> 	E39-L204 (SUS304)	Yes	Yes	Yes	---
<b>L-shaped Mounting Bracket</b> 	E39-L211 (SUS304)	--- <sup>1</sup>	--- <sup>1</sup>	--- <sup>1</sup>	Yes <sup>3</sup>
<b>Horizontal Protective Cover Bracket</b> 	E39-L212 (SUS304)	--- <sup>1</sup>	--- <sup>1</sup>	--- <sup>1</sup>	Yes <sup>3</sup>
<b>Robust Mounting Bracket</b> 	E39-L214 (SUS304)	--- <sup>1</sup>	--- <sup>1</sup>	--- <sup>1</sup>	Yes <sup>3</sup>

1. Can be used for Pre-wired models, M8 Pre-wired Connector models, and M12 Pre-wired Smartclick Connector models. However, confirm the bracket shape in advance.
2. Confirm the installation environment and bracket shape of the Sensor I/O Connector to be connected.
3. Use an L-shaped Sensor I/O Connector. Straight types cannot be installed.

# E3AS-L Series

## Ratings and Specifications

Item	Sensing method		Distance-settable	
	Model	NPN output	E3AS-L200MN	E3AS-L80MN
		PNP output/ COM2	E3AS-L200MD	E3AS-L80MD
	PNP output/ COM3	E3AS-L200MT	E3AS-L80MT	
Sensing distance		10 mm to the set distance (White paper or black paper 100 × 100 mm)		
Setting range		40 to 200 mm (White paper or black paper 100 × 100 mm)	20 to 80 mm (White paper or black paper 100 × 100 mm)	
Spot diameter (reference value)		25 × 25 mm at distance of 200 mm		4 mm dia. (at distance of 80 mm)
Differential travel		10% max. of set distance		White paper: 2% max. of set distance Black paper: 5% max. of set distance
Reflectivity characteristic (black/white error)		10% max. of set distance		5% max. of set distance
Light source (wavelength)		Red LED (624 nm)		Red LED (650 nm)
Power supply voltage		10 to 30 VDC (including 10% ripple (p-p)), Class2		
Current consumption		35 mA max.		
Input/output	Control output		Load power supply voltage: 30 VDC max., Class2. Load current: 100 mA max. (Residual voltage: Load current of less than 10 mA: 1 V max. Load current of 10 to 100 mA: 2 V max.) Open-collector output (NPN/PNP output depending on model)	
	NPN	OUTPUT 1: NO (Normally open), OUTPUT 2: NC (Normally closed)		
	PNP/COM2 PNP/COM3	OUTPUT 1: NO (Normally open)/COM□, OUTPUT 2: NC (Normally closed)		
Protection circuits		Power supply reverse polarity protection, Output short-circuit protection, and Output reverse polarity protection		
Response time		Operate or reset: 1 ms max.		
Distance setting		Teaching method/IO-Link communications		
Ambient illumination (Receiver side)		Incandescent lamp: 3,000 lx max., Sunlight: 10,000 lx max.		
Ambient temperature range		Operating: -25 to 55°C, Storage: -40 to 70°C (with no icing or condensation)		
Ambient humidity range		Operating: 35% to 85%, Storage: 35% to 95% (with no condensation)		
Insulation resistance		20 MΩ min. at 500 VDC		
Dielectric strength		1,000 VAC, 50/60 Hz for 1 min		
Vibration resistance		10 to 55 Hz with a 1.5-mm double amplitude for 2 hours each in X, Y, and Z directions		
Shock resistance		500 m/s <sup>2</sup> for 3 times each in X, Y, and Z directions		
Degree of protection		IP67 (IEC60529) and IP67G <sup>1</sup> (JIS C 0920 Annex 1), IP69K (ISO20653)		
Indicators		Operation indicator (orange), Stability & Communication indicator (green <sup>2</sup> )		
Connection method		Pre-wired (standard cable length: 2 m), M8 Connector, M8 Pre-wired Connector (standard cable length: 0.3m), M12 Pre-wired Smartclick Connector (standard cable length: 0.3m)		
Weight (packed state/ Sensor only)	Pre-wired (2 m)		Approx. 135 g/approx. 90 g	
	M8 Connector		Approx. 75 g/approx. 30 g	
	M8 Pre-wired Connector (0.3 m)		Approx. 85 g/approx. 40 g	
	M12 Pre-wired Smartclick Connector (0.3m)		Approx. 95 g/approx. 50 g	
Materials	Case		Stainless steel (SUS316L)	
	Lens		Methacrylate resin (PMMA)	
	Display		Polyamide 11 (PA11)	
Main IO-Link functions		Operation mode switching between NO and NC, execution of teaching (2-point teaching, Background teaching), setup of the threshold, timer function of the control output and timer time selecting, Restore Factory Settings, Key Lock (Unlock, Lock, Lock (No Button))		
IO-Link Communication specifications	IO-Link specification		Ver. 1.1	
	Baud rate		COM2 (38.4 kbps), COM3 (230.4 kbps)	
	Data length		PD size: 1 byte, OD size: 1 byte (M-sequence type: TYPE_2_1)	
	Minimum cycle time		COM2: 3.5 ms, COM3: 1.2 ms	
Accessories		Instruction manual, compliance sheet and index list (attached for IO-Link type only), Note: Mounting Brackets must be ordered separately.		

- The IP67G is the degree of protection which is defined according to the JIS (Japanese Industrial Standards).  
The IP67 indicates the same level of protection as defined by the IEC, and the G indicates that a device has resistance to oil.
- IO-Link Communication mode: blinking

# Engineering Data (Reference Value)

## Operating Range

**E3AS-L200**

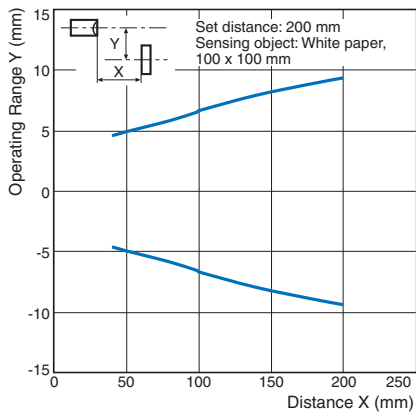

**E3AS-L80**

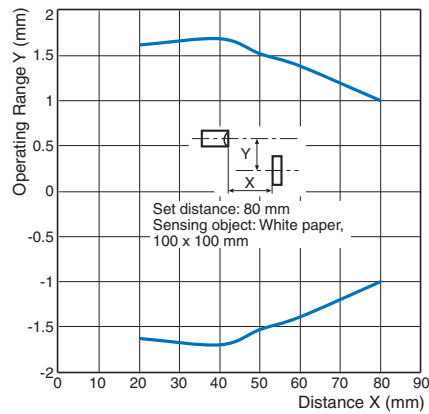

## Spot Diameter vs. Sensing Distance

**E3AS-L200**

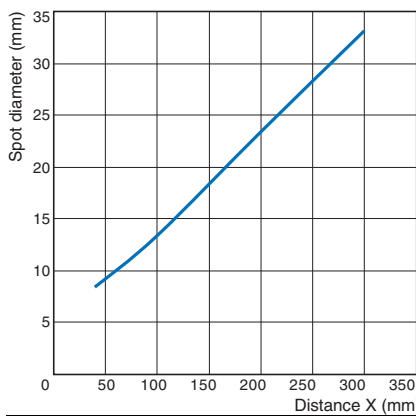

**E3AS-L80**

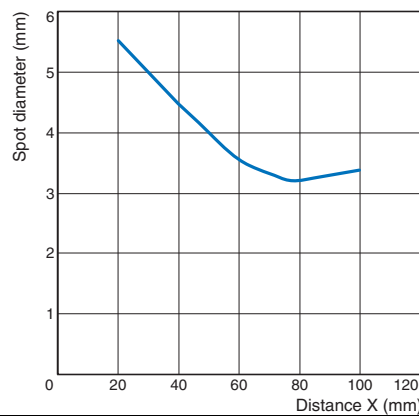

## Close-range Characteristics

**E3AS-L200**

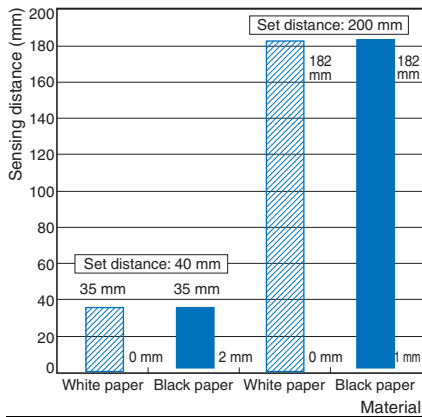

**E3AS-L80**

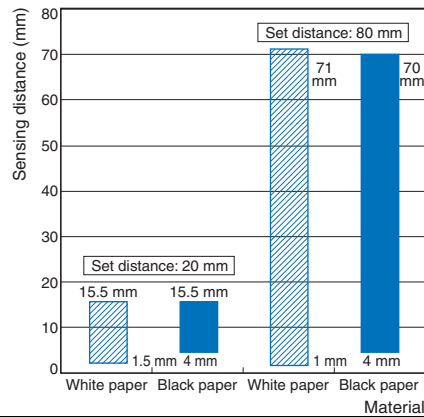

## Differential distance for each sensing object Vs. Distance

**E3AS-L200**

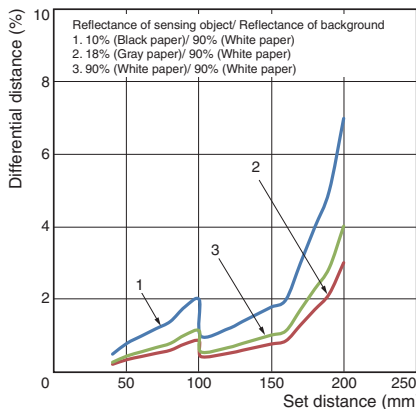

**E3AS-L80**

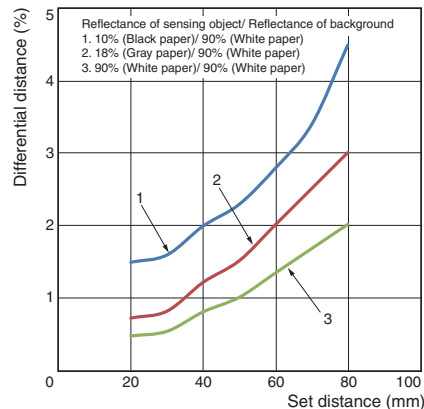

## Sensing Object Angle Characteristics

### E3AS-L200

#### Vertical

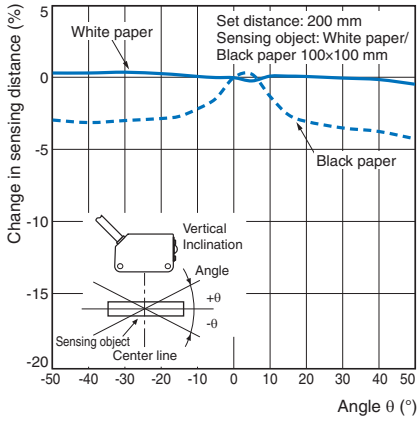

#### Horizontal

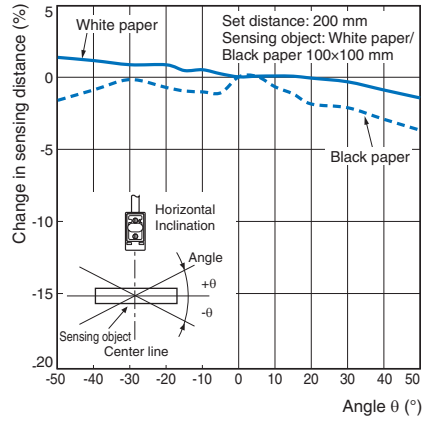

### E3AS-L80

#### Vertical

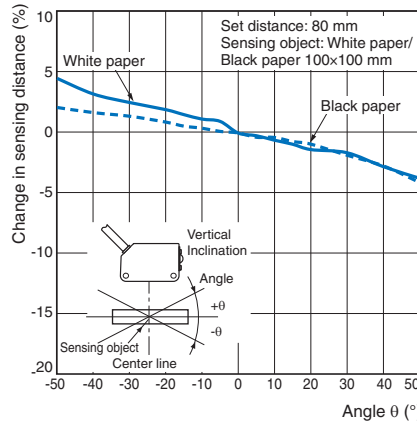

#### Horizontal

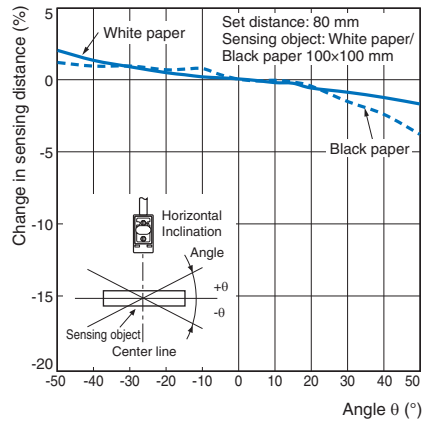

## Sensing Distance vs. Sensing Object Material

### E3AS-L200

(Set Distance of 200 mm using White Paper)

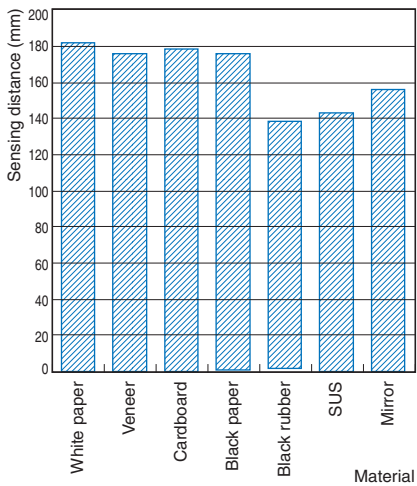

### E3AS-L80

(Set Distance of 80 mm using White Paper)

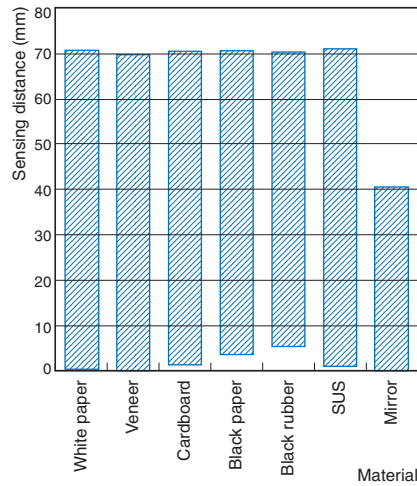

# I/O Circuit Diagrams/ Timing Charts

## NPN Output

Model	Timing chart	Output circuit
E3AS-L□N	<p>Stability&amp;Communication indicator (green) <sup>1</sup></p> <p>Operation indicator (orange)</p> <p>Control output 1</p> <p>Control output 2 <sup>2</sup></p>	<p>Connector Pin Arrangement</p> <p>M12 Pre-wired Smartclick Connector</p> <p>M8 Connector, M8 Pre-wired Connector</p>

1. Turns off when there is insufficient margin for incident light. In that case, place the workpiece closer to ensure sufficient receiving light intensity.
2. The initial value of control output 2 is reverse of control output 1.

## PNP Output

Model	Output circuit	
	Standard I/O mode (SIO mode) <sup>1</sup>	IO-Link Communication mode (COM mode) <sup>2</sup>
E3AS-L□D E3AS-L□T	<p>Connector Pin Arrangement</p> <p>M12 Pre-wired Smartclick Connector</p> <p>M8 Connector, M8 Pre-wired Connector</p>	<p>IO-Link Master Unit</p> <p>Connector Pin Arrangement</p> <p>M12 Pre-wired Smartclick Connector</p> <p>M8 Connector, M8 Pre-wired Connector</p>

1. Standard I/O mode is used as PNP ON/OFF output.
2. IO-Link Communication mode is used for communications with the IO-Link Master. C/Q performs IO-Link communications. Sensor output DO performs ON/OFF output.

Output mode	Timing charts	
		Threshold
Standard I/O mode (SIO mode)	Stability&Communication indicator (green) <sup>1</sup>	ON OFF
	Operation indicator (orange)	ON OFF
	Control output 1 <sup>3</sup>	ON OFF
	Control output 2 <sup>2</sup>	ON OFF
IO-Link Communication mode (COM mode)	Stability&Communication indicator (green)	Flashing (1 second cycle)
	Operation indicator (orange)	ON OFF
	Communication output	1 0
	Control output 2 <sup>2</sup>	ON OFF

1. Turns off when there is insufficient margin for incident light. In that case, place the workpiece closer to ensure sufficient receiving light intensity.
2. The initial value of control output 2 is reverse of control output 1.
3. The timer function of the control output 2 can be set up by the IO-Link communications. (It is able to select ON delay, OFF delay, or one-shot function and select a timer time of 1 to 9,999 ms (T).)

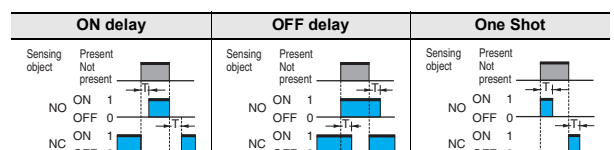

Please contact your Omron sales representative regarding the IO-Link setup file (IODD file).

**Note:** Shown above are the factory settings. Refer to the index list for the default settings at time of shipment from factory. PNP/COM output logic can be reversed by IO-Link communication. The operation indicator (orange) lights up when control output 1 is ON or communication output is 1.

## Nomenclature

E3AS-L200  
E3AS-L80

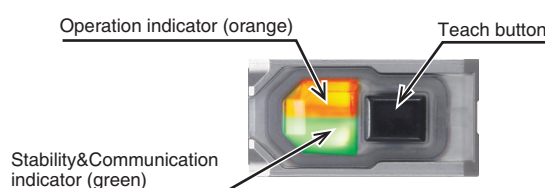



Note: The indicators work differently depending on sensor status.



## Safety Precautions

Be sure to read the precautions for all models in the website at: <http://www.ia.omron.com/>.

### Warning Indications

 <b>WARNING</b>	<b>Warning level</b> Indicates a potentially hazardous situation which, if not avoided, will result in minor or moderate injury, or may result in serious injury or death. Additionally there may be significant property damage.
 <b>CAUTION</b>	<b>Caution level</b> Indicates a potentially hazardous situation which, if not avoided, may result in minor or moderate injury or in property damage.
<b>Precautions for Safe Use</b>	Supplementary comments on what to do or avoid doing, to use the product safely.
<b>Precautions for Correct Use</b>	Supplementary comments on what to do or avoid doing, to prevent failure to operate, malfunction or undesirable effect on product performance.

### Meaning of Product Safety Symbols

	<b>General prohibition</b> Indicates the instructions of unspecified prohibited action
	<b>Caution, fire</b> Indicates the possibility of fires under specific conditions
	<b>General Caution</b> Indicates unspecified general alert
	<b>Caution, explosion</b> Indicates the possibility of explosion under specific conditions

### **WARNING**

This product is not designed or rated for ensuring safety of persons either directly or indirectly. Do not use it for such purpose.



Do not use the product with voltage in excess of the rated voltage. Excess voltage may result in malfunction or fire.



### **CAUTION**

Its component may be damaged and/or degree of protection may be degraded. Please do not apply high pressure water intensively at one place during cleaning.



Never use the product with an AC power supply. Otherwise, explosion may result.



### Precautions for Safe Use

The following precautions must be observed to ensure safe operation.

- (1) Do not reverse the power supply connection or connect to an AC current.
- (2) Do not short the load.
- (3) Be sure that before making supply the supply voltage is less than the maximum rated supply voltage (30 VDC).
- (4) Do not use the product in environments subject to flammable or explosive gases.
- (5) Do not use the product under a chemical or an oil environment without prior evaluation.
- (6) Do not attempt to modify the product.

### Precautions for Correct Use

- (1) Do not hit the product using a hammer for installation.
- (2) The product must be installed with the specified torque or less. For M8 connector, the proper tightening torque is from 0.3 to 0.4 N·m. For M12 connector, the proper tightening torque is from 0.39 to 0.49 N·m. In case of M12 smartclick connector, manually tighten the connector.
- (3) Do not use the product in any atmosphere or environment that exceeds the ratings.
- (4) Output pulses may occur when the power supply is turned OFF. We recommend that you turn OFF the power supply to the load or load line first.
- (5) Use an extension cable less than 100 m long for Standard I/O mode and less than 20 m for IO-Link Communication mode.
- (6) Do not pull on the cable with excessive strength.
- (7) Please wait for at least 100 ms after turning on the product's power until it is available for use.
- (8) Though this is type IP67, do not use in the water, rain or outdoors.
- (9) If the Sensor wiring is placed in the same conduits or ducts as high-voltage or high-power lines, inductive noise may cause malfunction or damage. Wire the cables separately or use a shielded cable.
- (10) Do not use the product in locations subject to direct sunlight.
- (11) Do not use the product where humidity is high and dew condensation may occur.
- (12) Do not use the product where corrosive gases may exist.
- (13) If high-pressure washing water and so on hits the teach button, it might lead to malfunctioning. So, consider use of the key lock function.
- (14) Do not apply high-pressure washing water directly to the sensor's light emitting / receiving surface from a short distance. As the antifouling feature may be impaired, keep a sufficient distance from the light emitting / receiving surface.
- (15) Do not use the product at a location subject to shock or vibration.
- (16) To use a commercially available switching regulator, FG (frame ground) must be grounded.
- (17) Do not use organic solvents (e.g. paint thinner and alcohol) for cleaning. Otherwise optical properties and protective structure may deteriorate.
- (18) Be sure to check the influence caused by surrounding environments such as background objects and LED lighting before using the product.
- (19)  Please dispose in accordance with applicable regulations.



## Dimensions

### Sensors

#### Pre-wired Models/Pre-wired Connector Models

E3AS-L200□ (-M1TJ/-M3J)

E3AS-L80□ (-M1TJ/-M3J)

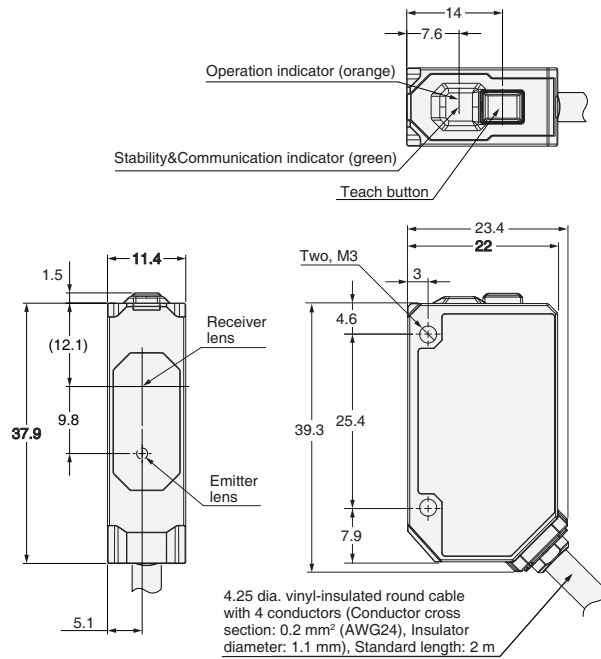

#### M12 Pre-wired Smartclick Connector type E3AS-L200□-M1TJ/E3AS-L80□-M1TJ

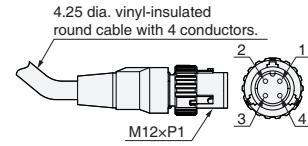

#### M8 Pre-wired connector type E3AS-L200□-M3J/E3AS-L80□-M3J

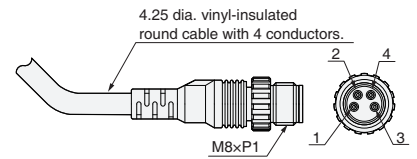

#### Minimum bending radius/unbendable length of cord

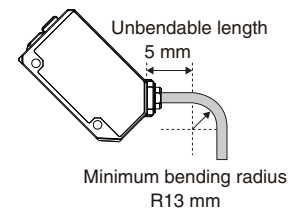

#### Connector Models

E3AS-L200□ M3

E3AS-L80□ M3

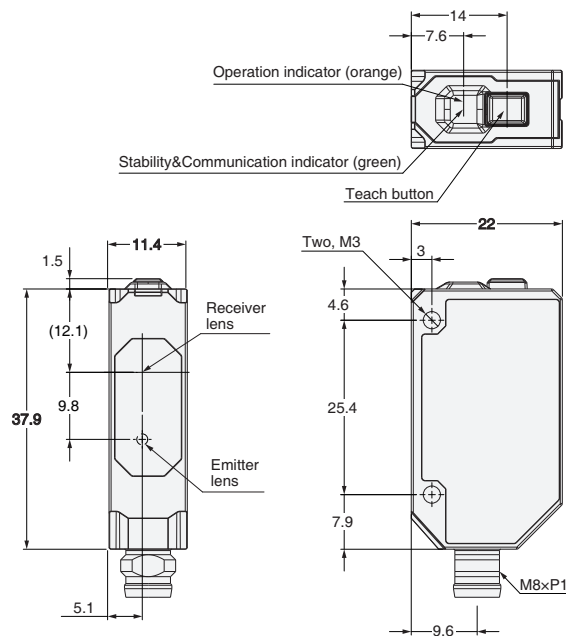

# E3AS-L Series

## Accessories (Sold Separately)

### Mounting Brackets

#### E39-L201

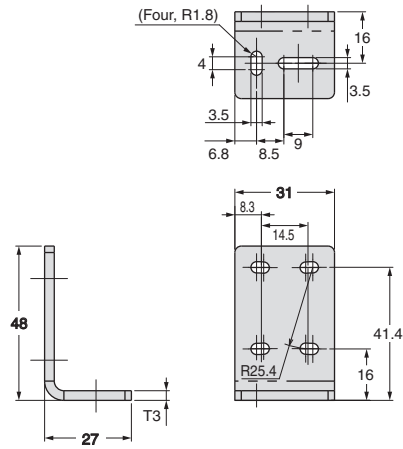

Photoelectric Sensor  
Accessory are installed  
(Example of E3AS-L200□)

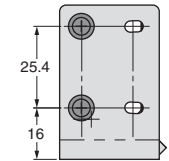
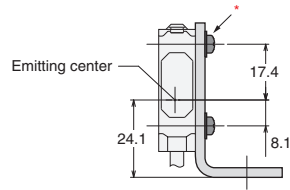
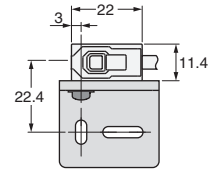

Material: Stainless steel (SUS304)

\* Accessories  
2-M3-L12 Cross Recessed Pan Head Screws (Attached to SW+JIS W)

#### E39-L202

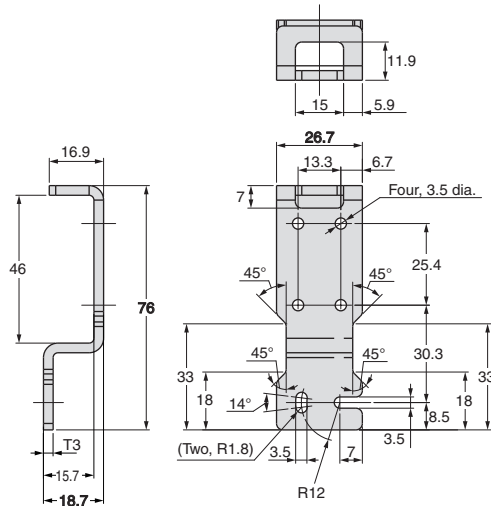

Photoelectric Sensor  
Accessory are installed  
(Example of E3AS-L200□)

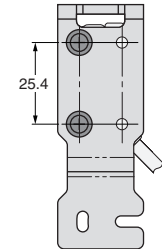
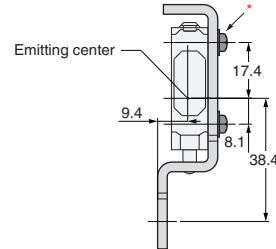
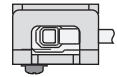

Material: Stainless steel (SUS304)

\* Accessories  
2-M3-L12 Cross Recessed Pan Head Screws (Attached to SW+JIS W)

#### E39-L203

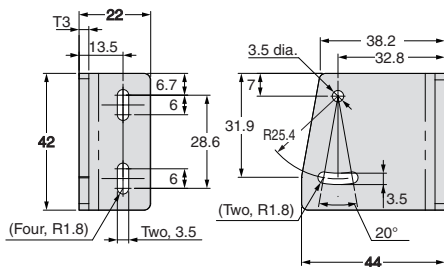

Photoelectric Sensor  
Accessory are installed  
(Example of E3AS-L200□)

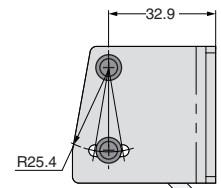
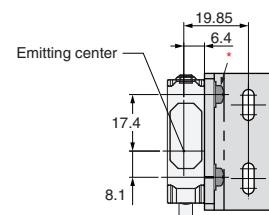

Material: Stainless steel (SUS304)

\* Accessories  
2-M3-L12 Cross Recessed Pan Head Screws (Attached to SW+JIS W)

E39-L204

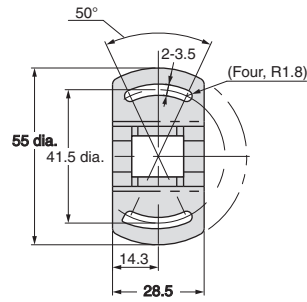

Photoelectric Sensor  
Accessory are installed  
(Example of E3AS-L200□)

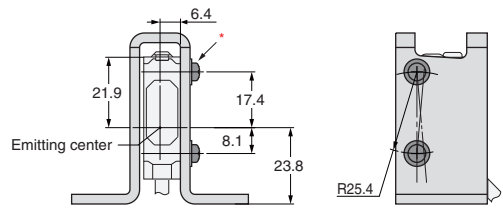
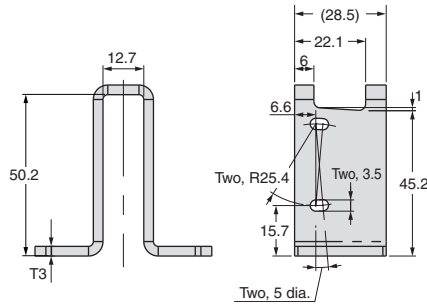
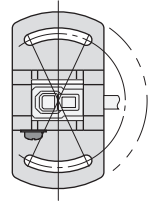

Material: Stainless steel (SUS304)

\* Accessories

2-M3-L12 Cross Recessed Pan Head Screws (Attached to SW+JIS W)

E39-L211

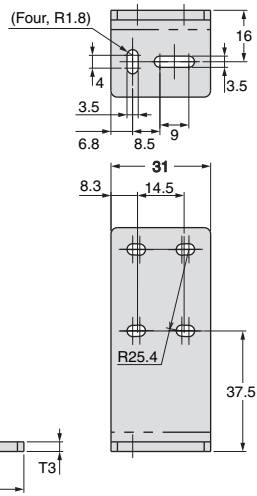

Photoelectric Sensor  
Accessory are installed  
(Example of E3AS-L200□)

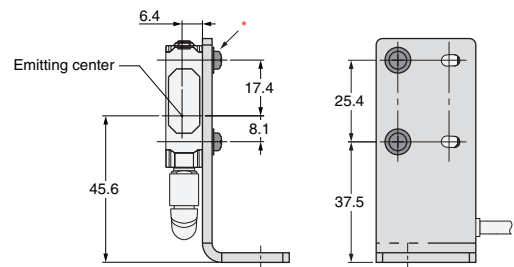
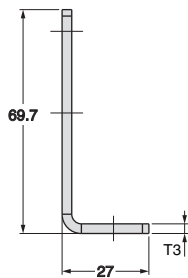
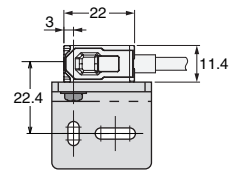

Material: Stainless steel (SUS304)

\* Accessories

2-M3-L12 Cross Recessed Pan Head Screws (Attached to SW+JIS W)

# E3AS-L Series

## E39-L212

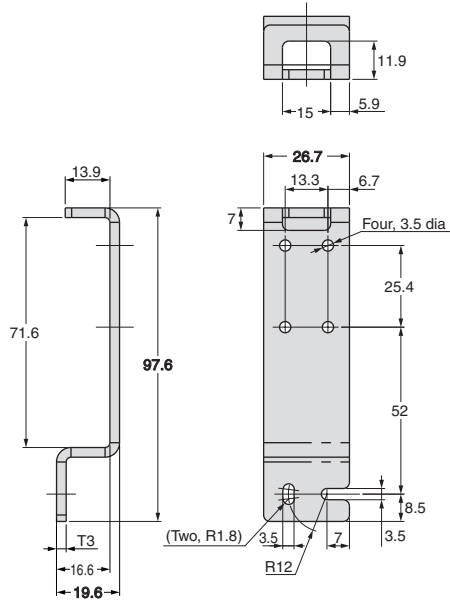

Photoelectric Sensor  
Accessory are installed  
(Example of E3AS-L200□)

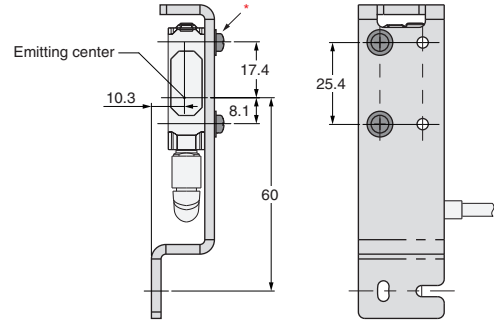
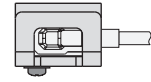

Material: Stainless steel (SUS304)

\* Accessories  
2-M3-L12 Cross Recessed Pan Head Screws (Attached to SW+JIS W)

## E39-L214

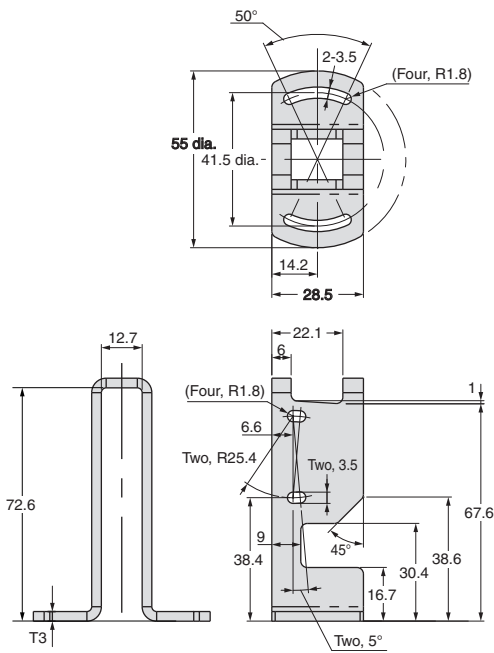

Photoelectric Sensor  
Accessory are installed  
(Example of E3AS-L200□)

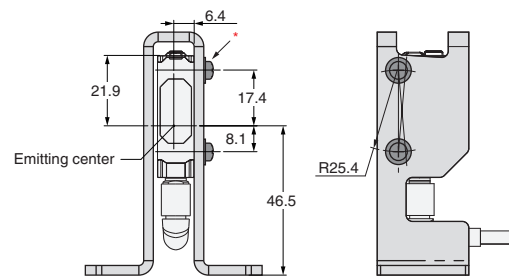
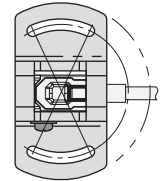

Material: Stainless steel (SUS304)

\* Accessories  
2-M3-L12 Cross Recessed Pan Head Screws (Attached to SW+JIS W)

**OMRON AUTOMATION AMERICAS HEADQUARTERS** • Chicago, IL USA • 847.843.7900 • 800.556.6766 • automation.omron.com

**OMRON CANADA, INC. • HEAD OFFICE**

Toronto, ON, Canada • 416.286.6465 • 866.986.6766 • automation.omron.com

**OMRON ELECTRONICS DE MEXICO • HEAD OFFICE**

Ciudad de México • 52.55.5901.4300 • 01.800.386.6766 • mela@omron.com

**OMRON ELECTRONICS DE MEXICO • SALES OFFICE**

San Pedro Garza García, N.L. • 81.12.53.7392 • 01.800.386.6766 • mela@omron.com

**OMRON ELECTRONICS DE MEXICO • SALES OFFICE**

Eugenio Garza Sada, León, Gto • 01.800.386.6766 • mela@omron.com

**OMRON ELETRÔNICA DO BRASIL LTDA • HEAD OFFICE**

São Paulo, SP, Brasil • 55.11.2101.6300 • www.omron.com.br

**OMRON ARGENTINA • SALES OFFICE**

Buenos Aires, Argentina • +54.11.4521.8630 • +54.11.4523.8483  
mela@omron.com

**OTHER OMRON LATIN AMERICA SALES**

+54.11.4521.8630 • +54.11.4523.8483 • mela@omron.com

*Authorized Distributor:*

**Controllers & I/O**

- Machine Automation Controllers (MAC) • Motion Controllers
- Programmable Logic Controllers (PLC) • Temperature Controllers • Remote I/O

**Robotics**

- Industrial Robots • Mobile Robots

**Operator Interfaces**

- Human Machine Interface (HMI)

**Motion & Drives**

- Machine Automation Controllers (MAC) • Motion Controllers • Servo Systems
- Frequency Inverters

**Vision, Measurement & Identification**

- Vision Sensors & Systems • Measurement Sensors • Auto Identification Systems

**Sensing**

- Photoelectric Sensors • Fiber-Optic Sensors • Proximity Sensors
- Rotary Encoders • Ultrasonic Sensors

**Safety**

- Safety Light Curtains • Safety Laser Scanners • Programmable Safety Systems
- Safety Mats and Edges • Safety Door Switches • Emergency Stop Devices
- Safety Switches & Operator Controls • Safety Monitoring/Force-guided Relays

**Control Components**

- Power Supplies • Timers • Counters • Programmable Relays
- Digital Panel Meters • Monitoring Products

**Switches & Relays**

- Limit Switches • Pushbutton Switches • Electromechanical Relays
- Solid State Relays

**Software**

- Programming & Configuration • Runtime