

XLamp® XP-G3 LEDs

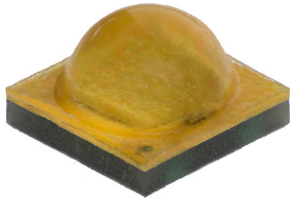

XP-G3 White

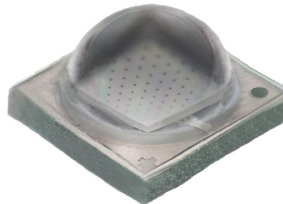

XP-G3 Royal Blue

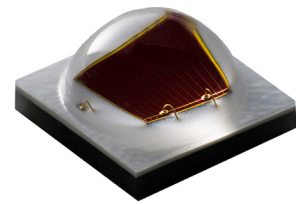

XP-G3 Photo Red

PRODUCT DESCRIPTION

XLamp® XP-G3 LEDs are optimized for directional, high-lumen lighting applications where efficacy and optical control are critical, such as roadway, portable and horticulture. The compact and proven 3.45-mm XP platform has an excellent ecosystem of optics and system solutions available, enabling lighting manufacturers to simplify their design process and shorten time-to-market.

XP-G3 LEDs are available in Royal Blue and two different White and Photo Red versions: Standard & S Line. The White Standard version delivers best-in-class TM-21 lifetimes and color stability over time. The S Line versions of White and Photo Red deliver improved efficiency, best-in-class sulfur resistance and better system-level reliability through switching and dimming cycles. With these S Line versions, Cree LED delivers high-power LED technology that is optimized for both general and horticulture lighting applications where sensors and switching are becoming common.

In this document, the terms White and Photo Red denote the white or photo red XP-G3 LED without regard to its Standard or S Line features. The terms Standard and S Line are used when necessary to differentiate the performance of the Standard XP-G3 LED from the XP-G3 LED with the S Line option.

FEATURES

- Available in no CRI minimum white, 70-, 80- and 90-CRI white, royal blue & photo red
- Broadcast color option at 5700 K
- ANSI-compatible chromaticity bins
- 3-step and 5-step options
- White binned at 85 °C, royal blue & photo red binned at 25 °C
- Maximum drive current: white, royal blue: 2000 mA, photo red: 1500 mA
- Low thermal resistance: white: 3 °C/W, royal blue: 2 °C/W, photo red (Standard): 2.5 °C/W, photo red (S Line): 1 °C/W
- Wide viewing angle: 125°–130°
- Unlimited floor life at ≤ 30 °C/85% RH
- Reflow solderable - JEDEC J-STD-020C
- Electrically neutral thermal path
- RoHS and REACH compliant
- UL® recognized component (E349212)



Cree LED / 4400 Silicon Drive / Durham, NC 27703 USA / +1.919.313.5330 / www.cree-led.com

TABLE OF CONTENTS

Characteristics 3

Order Codes Suggested for New Designs - White (Standard) 4

Order Codes Suggested for New Designs - White (S Line) 10

Flux Characteristics - Color (Standard) 12

Flux Characteristics - Color (S Line) 12

Flux Characteristics - Broadcast Order Codes and Bins..... 13

Relative Spectral Power Distribution - White (Standard) 14

Relative Spectral Power Distribution - White (S Line) 14

Relative Spectral Power Distribution - Color 15

Relative Flux vs. Junction Temperature - White (Standard) 15

Relative Flux vs. Junction Temperature - White (S Line) 16

Relative Flux vs. Junction Temperature - Color..... 16

Electrical Characteristics - White (Standard) 17

Electrical Characteristics - White (S Line) 17

Electrical Characteristics - Color..... 18

Relative Luminous Flux vs. Current - White (Standard) 18

Relative Luminous Flux vs. Current - White (S Line) 19

Relative Radiant Flux vs. Current - Color 19

Relative Chromaticity vs. Current and Temperature 20

Typical Spatial Distribution - White (Standard) 21

Typical Spatial Distribution - White (S Line) 21

Typical Spatial Distribution - Color..... 22

Thermal Design 23

Performance Groups - Luminous Flux..... 24

Performance Groups - Radiant Flux..... 25

Performance Groups - Peak Wavelength..... 26

Performance Groups - Forward Voltage..... 26

Performance Groups - Chromaticity 27

Standard Cool White Kits Plotted on ANSI Standard Chromaticity Regions..... 31

Standard Warm and Neutral White Kits Plotted on ANSI Standard Chromaticity Regions 32

EasyWhite® White Kits Plotted on ANSI Standard Chromaticity Regions 33

Standard Chromaticity Kits 34

Bin and Order Code Formats 35

Reflow Soldering Characteristics..... 36

Notes 37

Mechanical Dimensions 39

Tape and Reel..... 40

Packaging..... 41

Appendix - Order Codes Not For New Designs 42

CHARACTERISTICS

Characteristics	Unit	Minimum	Typical	Maximum
Thermal resistance, junction to solder point - white	°C/W		3	
Thermal resistance, junction to solder point - royal blue	°C/W		2	
Thermal resistance, junction to solder point - photo red (Standard)	°C/W		2.5	
Thermal resistance, junction to solder point - photo red (S Line)	°C/W		1	
Viewing angle (FWHM) - white	degrees		125	
Viewing angle (FWHM) - royal blue	degrees		130	
Viewing angle (FWHM) - photo red	degrees		125	
Temperature coefficient of voltage	mV/°C		-1.6	
ESD withstand voltage (HBM per Mil-Std-883D)			Class 3A	
DC forward current - white, royal blue	mA			2000
DC forward current - photo red	mA			1500
Reverse voltage	V			1
Forward voltage (@ 350 mA, 85 °C) - white	V		2.70	2.90
Forward voltage (@ 350 mA, 25 °C) - royal blue	V		2.79	3.0
Forward voltage (@ 350 mA, 25 °C) - photo red (Standard)	V		1.99	2.2
Forward voltage (@ 350 mA, 25 °C) - photo red (S Line)	V		1.95	2.2
Forward voltage (@ 700 mA, 85 °C) - white	V		2.80	
Forward voltage (@ 700 mA, 25 °C) - royal blue	V		2.90	
Forward voltage (@ 700 mA, 25 °C) - photo red (Standard)	V		2.18	
Forward voltage (@ 700 mA, 25 °C) - photo red (S Line)	V		2.13	
Forward voltage (@ 1000 mA, 85 °C) - white	V		2.87	
Forward voltage (@ 1000 mA, 25 °C) - royal blue	V		2.99	
Forward voltage (@ 1000 mA, 25 °C) - photo red (Standard)	V		2.36	
Forward voltage (@ 1000 mA, 25 °C) - photo red (S Line)	V		2.26	
Forward voltage (@ 1500 mA, 85 °C) - white	V		2.97	
Forward voltage (@ 1500 mA, 25 °C) - royal blue	V		3.11	
Forward voltage (@ 1500 mA, 25 °C) - photo red (Standard)	V		2.65	
Forward voltage (@ 1500 mA, 25 °C) - photo red (S Line)	V		2.46	
Forward voltage (@ 2000 mA, 85 °C) - white	V		3.06	
Forward voltage (@ 2000 mA, 25 °C) - royal blue	V		3.20	
LED junction temperature	°C			150

ORDER CODES SUGGESTED FOR NEW DESIGNS - WHITE (STANDARD) - T_j = 85 °C

The following table provides order codes for XLamp XP-G3 White (Standard) LEDs. For a complete description of the order code nomenclature, please see the Bin and Order Code Formats section (page 36). For definitions of the chromaticity kits, please see the Standard Chromaticity Kits section (page 35).

Chromaticity		Minimum Luminous Flux (lm) @ 350 mA			Order Codes			
Kit	CCT	Code	Flux (lm) @ 85 °C	Flux (lm) @ 25 °C*	70 CRI Typical	70 CRI Minimum	80 CRI Minimum	90 CRI Minimum
DT	7000 K	S6	180	196		XPGDWT-B1-0000-00NDT		
		S5	172	187	XPGDWT-01-0000-00MDT	XPGDWT-B1-0000-00MDT		
		S4	164	179	XPGDWT-01-0000-00LDT	XPGDWT-B1-0000-00LDT	XPGDWT-H1-0000-00LDT	
		S3	156	170	XPGDWT-01-0000-00KDT	XPGDWT-B1-0000-00KDT	XPGDWT-H1-0000-00KDT	
		S2	148	161	XPGDWT-01-0000-00JDT			
CB	6500 K	S4	164	179			XPGDWT-H1-0000-00LCB	
		S3	156	170			XPGDWT-H1-0000-00KCB	
E0	>6500 K	S5	172	187	XPGDWT-01-0000-00ME0	XPGDWT-B1-0000-00ME0		
		S4	164	179	XPGDWT-01-0000-00LE0	XPGDWT-B1-0000-00LE0		
		S3	156	170		XPGDWT-B1-0000-00KE0	XPGDWT-H1-0000-00KE0	
E1	6500 K	S5	172	187	XPGDWT-01-0000-00ME1	XPGDWT-B1-0000-00ME1		
		S4	164	179	XPGDWT-01-0000-00LE1	XPGDWT-B1-0000-00LE1	XPGDWT-H1-0000-00LE1	
		S3	156	170		XPGDWT-B1-0000-00KE1	XPGDWT-H1-0000-00KE1	
DV	6000 K	S6	180	196		XPGDWT-B1-0000-00NDV		
		S5	172	187	XPGDWT-01-0000-00MDV	XPGDWT-B1-0000-00MDV		
		S4	164	179	XPGDWT-01-0000-00LDV	XPGDWT-B1-0000-00LDV	XPGDWT-H1-0000-00LDV	
		S3	156	170		XPGDWT-B1-0000-00KDV	XPGDWT-H1-0000-00KDV	
		S2	148	161				XPGDWT-U1-0000-00JDV
		R5	139	152				XPGDWT-U1-0000-00HDV
		R4	130	142				XPGDWT-U1-0000-00GDV
50	6000 K	S5	172	187	XPGDWT-01-0000-00M50	XPGDWT-B1-0000-00M50		
		S4	164	179	XPGDWT-01-0000-00L50	XPGDWT-B1-0000-00L50	XPGDWT-H1-0000-00L50	
		S3	156	170		XPGDWT-B1-0000-00K50	XPGDWT-H1-0000-00K50	
		S2	148	161				XPGDWT-U1-0000-00J50
		R5	139	152				XPGDWT-U1-0000-00H50
		R4	130	142				XPGDWT-U1-0000-00G50

Notes

- Cree LED maintains a tolerance of ±7% on flux and power measurements, ±0.005 on chromaticity (CCx, CCy) measurements and a tolerance of ±2 on CRI measurements. See the Measurements section (page 38).
- XLamp XP-G3 LED order codes specify only a minimum flux bin and not a maximum. Cree LED may ship reels in flux bins higher than the minimum specified by the order code without advance notice. Shipments will always adhere to the chromaticity bin restrictions specified by the order code.
- * Flux values @ 25 °C are calculated and for reference only.

ORDER CODES SUGGESTED FOR NEW DESIGNS - WHITE (STANDARD) - T_j = 85 °C (CONTINUED)

Chromaticity		Minimum Luminous Flux (lm) @ 350 mA			Order Codes			
Kit	CCT	Code	Flux (lm) @ 85 °C	Flux (lm) @ 25 °C*	70 CRI Typical	70 CRI Minimum	80 CRI Minimum	90 CRI Minimum
E2	5700 K	S6	180	196	XPGDWT-01-0000-00NE2	XPGDWT-B1-0000-00NE2		
		S5	172	187	XPGDWT-01-0000-00ME2	XPGDWT-B1-0000-00ME2		
		S4	164	179	XPGDWT-01-0000-00LE2	XPGDWT-B1-0000-00LE2	XPGDWT-H1-0000-00LE2	
		S3	156	170		XPGDWT-B1-0000-00KE2	XPGDWT-H1-0000-00KE2	
		S2	148	161				XPGDWT-U1-0000-00JE2
		R5	139	152				XPGDWT-U1-0000-00HE2
		R4	130	142				XPGDWT-U1-0000-00GE2
2E	5700 K	S6	180	196		XPGDWT-B1-0000-00N2E		
		S5	172	187		XPGDWT-B1-0000-00M2E		
		S4	164	179		XPGDWT-B1-0000-00L2E	XPGDWT-H1-0000-00L2E	
		S3	156	170		XPGDWT-B1-0000-00K2E	XPGDWT-H1-0000-00K2E	
		S2	148	161				XPGDWT-U1-0000-00J2E
		R5	139	152				XPGDWT-U1-0000-00H2E
		R4	130	142				XPGDWT-U1-0000-00G2E
3E	5000 K	S6	180	196		XPGDWT-B1-0000-00N3E		
		S5	172	187		XPGDWT-B1-0000-00M3E		
		S4	164	179		XPGDWT-B1-0000-00L3E	XPGDWT-H1-0000-00L3E	
		S3	156	170		XPGDWT-B1-0000-00K3E	XPGDWT-H1-0000-00K3E	
		S2	148	161				XPGDWT-U1-0000-00J3E
		R5	139	152				XPGDWT-U1-0000-00H3E
		R4	130	142				XPGDWT-U1-0000-00G4E
E3	5000 K	S6	180	196	XPGDWT-01-0000-00NE3	XPGDWT-B1-0000-00NE3		
		S5	172	187	XPGDWT-01-0000-00ME3	XPGDWT-B1-0000-00ME3		
		S4	164	179	XPGDWT-01-0000-00LE3	XPGDWT-B1-0000-00LE3	XPGDWT-H1-0000-00LE3	
		S3	156	170			XPGDWT-H1-0000-00KE3	
		S2	148	161				XPGDWT-U1-0000-00JE3
		R5	139	152				XPGDWT-U1-0000-00HE3
		R4	130	142				XPGDWT-U1-0000-00GE3

Notes

- Cree LED maintains a tolerance of ±7% on flux and power measurements, ±0.005 on chromaticity (CCx, CCy) measurements and a tolerance of ±2 on CRI measurements. See the Measurements section (page 38).
- XLamp XP-G3 LED order codes specify only a minimum flux bin and not a maximum. Cree LED may ship reels in flux bins higher than the minimum specified by the order code without advance notice. Shipments will always adhere to the chromaticity bin restrictions specified by the order code.
- * Flux values @ 25 °C are calculated and for reference only.

ORDER CODES SUGGESTED FOR NEW DESIGNS - WHITE (STANDARD) - T_j = 85 °C (CONTINUED)

Chromaticity		Minimum Luminous Flux (lm) @ 350 mA			Order Codes			
Kit	CCT	Code	Flux (lm) @ 85 °C	Flux (lm) @ 25 °C*	70 CRI Typical	70 CRI Minimum	80 CRI Minimum	90 CRI Minimum
F4	4750 K	S6	180	196	XPGDWT-01-0000-00NF4	XPGDWT-B1-0000-00NF4		
		S5	172	187	XPGDWT-01-0000-00MF4	XPGDWT-B1-0000-00MF4		
		S4	164	179	XPGDWT-01-0000-00LF4	XPGDWT-B1-0000-00LF4	XPGDWT-H1-0000-00LF4	
		S3	156	170			XPGDWT-H1-0000-00KF4	
		S2	148	161			XPGDWT-H1-0000-00JF4	XPGDWT-U1-0000-00JF4
		R5	139	152				XPGDWT-U1-0000-00HF4
		R4	130	142				XPGDWT-U1-0000-00GF4
4E	4500 K	S6	180	196		XPGDWT-B1-0000-00N4E		
		S5	172	187		XPGDWT-B1-0000-00M4E		
		S4	164	179		XPGDWT-B1-0000-00L4E	XPGDWT-H1-0000-00L4E	
		S3	156	170			XPGDWT-H1-0000-00K4E	
		S2	148	161			XPGDWT-H1-0000-00J4E	XPGDWT-U1-0000-00J4E
		R5	139	152				XPGDWT-U1-0000-00H4E
		R4	130	142				XPGDWT-U1-0000-00G4E
E4	4500 K	S6	180	196	XPGDWT-01-0000-00NE4	XPGDWT-B1-0000-00NE4		
		S5	172	187	XPGDWT-01-0000-00ME4	XPGDWT-B1-0000-00ME4		
		S4	164	179	XPGDWT-01-0000-00LE4	XPGDWT-B1-0000-00LE4	XPGDWT-H1-0000-00LE4	
		S3	156	170			XPGDWT-H1-0000-00KE4	
		S2	148	161			XPGDWT-H1-0000-00JE4	XPGDWT-U1-0000-00JE4
		R5	139	152				XPGDWT-U1-0000-00HE4
		R4	130	142				XPGDWT-U1-0000-00GE4
F5	4200 K	S6	180	196		XPGDWT-B1-0000-00NF5		
		S5	172	187	XPGDWT-01-0000-00MF5	XPGDWT-B1-0000-00MF5		
		S4	164	179	XPGDWT-01-0000-00LF5	XPGDWT-B1-0000-00LF5	XPGDWT-H1-0000-00LF5	
		S3	156	170		XPGDWT-B1-0000-00KF5	XPGDWT-H1-0000-00KF5	
		S2	148	161			XPGDWT-H1-0000-00JF5	XPGDWT-U1-0000-00JF5
		R5	139	152				XPGDWT-U1-0000-00HF5
		R4	130	142				XPGDWT-U1-0000-00GF5

Notes

- Cree LED maintains a tolerance of ±7% on flux and power measurements, ±0.005 on chromaticity (CCx, CCy) measurements and a tolerance of ±2 on CRI measurements. See the Measurements section (page 38).
- XLamp XP-G3 LED order codes specify only a minimum flux bin and not a maximum. Cree LED may ship reels in flux bins higher than the minimum specified by the order code without advance notice. Shipments will always adhere to the chromaticity bin restrictions specified by the order code.
- * Flux values @ 25 °C are calculated and for reference only.

ORDER CODES SUGGESTED FOR NEW DESIGNS - WHITE (STANDARD) - T_j = 85 °C (CONTINUED)

Chromaticity		Minimum Luminous Flux (lm) @ 350 mA			Order Codes			
Kit	CCT	Code	Flux (lm) @ 85 °C	Flux (lm) @ 25 °C*	70 CRI Typical	70 CRI Minimum	80 CRI Minimum	90 CRI Minimum
5E	4000 K	S6	180	196		XPGDWT-B1-0000-00N5E		
		S5	172	187		XPGDWT-B1-0000-00M5E		
		S4	164	179		XPGDWT-B1-0000-00L5E	XPGDWT-H1-0000-00L5E	
		S3	156	170		XPGDWT-B1-0000-00K5E	XPGDWT-H1-0000-00K5E	
		S2	148	161			XPGDWT-H1-0000-00J5E	XPGDWT-U1-0000-00J5E
		R5	139	152				XPGDWT-U1-0000-00H5E
		R4	130	142				XPGDWT-U1-0000-00G5E
E5	4000 K	S6	180	196		XPGDWT-B1-0000-00NE5		
		S5	172	187	XPGDWT-01-0000-00ME5	XPGDWT-B1-0000-00ME5		
		S4	164	179	XPGDWT-01-0000-00LE5	XPGDWT-B1-0000-00LE5	XPGDWT-H1-0000-00LE5	
		S3	156	170		XPGDWT-B1-0000-00KE5	XPGDWT-H1-0000-00KE5	
		S2	148	161			XPGDWT-H1-0000-00JE5	XPGDWT-U1-0000-00JE5
		R5	139	152				XPGDWT-U1-0000-00HE5
		R4	130	142				XPGDWT-U1-0000-00GE5
F6	3700 K	S5	172	187		XPGDWT-B1-0000-00MF6		
		S4	164	179	XPGDWT-01-0000-00LF6	XPGDWT-B1-0000-00LF6		
		S3	156	170	XPGDWT-01-0000-00KF6	XPGDWT-B1-0000-00KF6	XPGDWT-H1-0000-00KF6	
		S2	148	161			XPGDWT-H1-0000-00JF6	
		R5	139	152			XPGDWT-H1-0000-00HF6	XPGDWT-U1-0000-00HF6
		R4	130	142				XPGDWT-U1-0000-00GF6
6E	3500 K	S5	172	187		XPGDWT-B1-0000-00M6E		
		S4	164	179		XPGDWT-B1-0000-00L6E		
		S3	156	170		XPGDWT-B1-0000-00K6E	XPGDWT-H1-0000-00K6E	
		S2	148	161			XPGDWT-H1-0000-00J6E	
		R5	139	152			XPGDWT-H1-0000-00H6E	XPGDWT-U1-0000-00H6E
		R4	130	142				XPGDWT-U1-0000-00G6E
6G	3500 K	R5	139	152				XPGDWT-U1-0000-00H6G
		R4	130	142				XPGDWT-U1-0000-00G6G

Notes

- Cree LED maintains a tolerance of ±7% on flux and power measurements, ±0.005 on chromaticity (CCx, CCy) measurements and a tolerance of ±2 on CRI measurements. See the Measurements section (page 38).
- XLamp XP-G3 LED order codes specify only a minimum flux bin and not a maximum. Cree LED may ship reels in flux bins higher than the minimum specified by the order code without advance notice. Shipments will always adhere to the chromaticity bin restrictions specified by the order code.
- * Flux values @ 25 °C are calculated and for reference only.

ORDER CODES SUGGESTED FOR NEW DESIGNS - WHITE (STANDARD) - T_J = 85 °C (CONTINUED)

Chromaticity		Minimum Luminous Flux (lm) @ 350 mA			Order Codes			
Kit	CCT	Code	Flux (lm) @ 85 °C	Flux (lm) @ 25 °C*	70 CRI Typical	70 CRI Minimum	80 CRI Minimum	90 CRI Minimum
E6	3500 K	S5	172	187		XPGDWT-B1-0000-00ME6		
		S4	164	179	XPGDWT-01-0000-00LE6	XPGDWT-B1-0000-00LE6		
		S3	156	170	XPGDWT-01-0000-00KE6	XPGDWT-B1-0000-00KE6	XPGDWT-H1-0000-00KE6	
		S2	148	161			XPGDWT-H1-0000-00JE6	
		R5	139	152			XPGDWT-H1-0000-00HE6	XPGDWT-U1-0000-00HE6
		R4	130	142				XPGDWT-U1-0000-00GE6
F7	3200 K	S5	172	187		XPGDWT-B1-0000-00MF7		
		S4	164	179	XPGDWT-01-0000-00LF7	XPGDWT-B1-0000-00LF7		
		S3	156	170	XPGDWT-01-0000-00KF7	XPGDWT-B1-0000-00KF7	XPGDWT-H1-0000-00KF7	
		S2	148	161	XPGDWT-01-0000-00JF7	XPGDWT-B1-0000-00JF7	XPGDWT-H1-0000-00JF7	
		R5	139	152			XPGDWT-H1-0000-00HF7	
		R4	130	142				XPGDWT-U1-0000-00GF7
		R3	122	133				XPGDWT-U1-0000-00FF7
7E	3000 K	S5	172	187		XPGDWT-B1-0000-00M7E		
		S4	164	179		XPGDWT-B1-0000-00L7E		
		S3	156	170		XPGDWT-B1-0000-00K7E	XPGDWT-H1-0000-00K7E	
		S2	148	161		XPGDWT-B1-0000-00J7E	XPGDWT-H1-0000-00J7E	
		R5	139	152			XPGDWT-H1-0000-00H7E	
		R4	130	142				XPGDWT-U1-0000-00G7E
		R3	122	133				XPGDWT-U1-0000-00F7E
7G	3000 K	R4	130	142				XPGDWT-U1-0000-00G7G
		R3	122	133				XPGDWT-U1-0000-00F7G
E7	3000 K	S5	172	187		XPGDWT-B1-0000-00ME7		
		S4	164	179	XPGDWT-01-0000-00LE7	XPGDWT-B1-0000-00LE7		
		S3	156	170	XPGDWT-01-0000-00KE7	XPGDWT-B1-0000-00KE7	XPGDWT-H1-0000-00KE7	
		S2	148	161	XPGDWT-01-0000-00JE7	XPGDWT-B1-0000-00JE7	XPGDWT-H1-0000-00JE7	
		R5	139	152			XPGDWT-H1-0000-00HE7	
		R4	130	142				XPGDWT-U1-0000-00GE7
		R3	122	133				XPGDWT-U1-0000-00FE7

Notes

- Cree LED maintains a tolerance of ±7% on flux and power measurements, ±0.005 on chromaticity (CCx, CCy) measurements and a tolerance of ±2 on CRI measurements. See the Measurements section (page 38).
- XLamp XP-G3 LED order codes specify only a minimum flux bin and not a maximum. Cree LED may ship reels in flux bins higher than the minimum specified by the order code without advance notice. Shipments will always adhere to the chromaticity bin restrictions specified by the order code.
- * Flux values @ 25 °C are calculated and for reference only.

ORDER CODES SUGGESTED FOR NEW DESIGNS - WHITE (STANDARD) - T_J = 85 °C (CONTINUED)

Chromaticity		Minimum Luminous Flux (lm) @ 350 mA			Order Codes			
Kit	CCT	Code	Flux (lm) @ 85 °C	Flux (lm) @ 25 °C*	70 CRI Typical	70 CRI Minimum	80 CRI Minimum	90 CRI Minimum
F8	2850 K	S2	148	161			XPGDWT-H1-0000-00JF8	
		R5	139	152			XPGDWT-H1-0000-00HF8	
		R4	130	142			XPGDWT-H1-0000-00GF8	
		R3	122	133				XPGDWT-U1-0000-00FF8
		R2	114	124				XPGDWT-U1-0000-00EF8
8E	2700 K	S4	164	179		XPGDWT-B1-0000-00L8E		
		S3	156	170		XPGDWT-B1-0000-00K8E		
		S2	148	161		XPGDWT-B1-0000-00J8E	XPGDWT-H1-0000-00J8E	
		R5	139	152			XPGDWT-H1-0000-00H8E	
		R4	130	142			XPGDWT-H1-0000-00G8E	
		R3	122	133				XPGDWT-U1-0000-00F8E
		R2	114	124				XPGDWT-U1-0000-00E8E
8G	2700 K	R3	122	133				XPGDWT-U1-0000-00F8G
		R2	114	124				XPGDWT-U1-0000-00E8G
E8	2700 K	S4	164	179		XPGDWT-B1-0000-00LE8		
		S3	156	170		XPGDWT-B1-0000-00KE8		
		S2	148	161		XPGDWT-B1-0000-00JE8	XPGDWT-H1-0000-00JE8	
		R5	139	152			XPGDWT-H1-0000-00HE8	
		R4	130	142			XPGDWT-H1-0000-00GE8	
		R3	122	133				XPGDWT-U1-0000-00FE8
		R2	114	124				XPGDWT-U1-0000-00EE8
EA	2200 K	R5	139	152		XPGDWT-B1-0000-00HEA		
		R4	130	142		XPGDWT-B1-0000-00GEA		
BE	1800 K	R3	122	133	XPGDWT-01-0000-00FBE			
		R2	114	124	XPGDWT-01-0000-00EBE			

Notes

- Cree LED maintains a tolerance of ±7% on flux and power measurements, ±0.005 on chromaticity (CCx, CCy) measurements and a tolerance of ±2 on CRI measurements. See the Measurements section (page 38).
- XLamp XP-G3 LED order codes specify only a minimum flux bin and not a maximum. Cree LED may ship reels in flux bins higher than the minimum specified by the order code without advance notice. Shipments will always adhere to the chromaticity bin restrictions specified by the order code.
- * Flux values @ 25 °C are calculated and for reference only.

ORDER CODES SUGGESTED FOR NEW DESIGNS - WHITE (S LINE) - T_J = 85 °C

The following table provides order codes for XLamp XP-G3 White (S Line) LEDs. For a complete description of the order code nomenclature, please see the Bin and Order Code Formats section (page 36). For definitions of the chromaticity kits, please see the Standard Chromaticity Kits section (page 35).

Chromaticity		Minimum Luminous Flux (lm) @ 350 mA			Order Codes
Kit	CCT	Code	Flux (lm) @ 85 °C	Flux (lm) @ 25 °C*	70 CRI Minimum
E1	6500 K	S6	180	196	XPGDWT-BS-0000-00NE1
		S5	172	187	XPGDWT-BS-0000-00ME1
		S4	164	179	XPGDWT-BS-0000-00LE1
DV	6000 K	S6	180	196	XPGDWT-BS-0000-00NDV
		S5	172	187	XPGDWT-BS-0000-00MDV
		S4	164	179	XPGDWT-BS-0000-00LDV
50	6000 K	S6	180	196	XPGDWT-BS-0000-00N50
		S5	172	187	XPGDWT-BS-0000-00M50
		S4	164	179	XPGDWT-BS-0000-00L50
E2	5700 K	S7	188	205	XPGDWT-BS-0000-00PE2
		S6	180	196	XPGDWT-BS-0000-00NE2
		S5	172	187	XPGDWT-BS-0000-00ME2
		S4	164	179	XPGDWT-BS-0000-00LE2
2E	5700 K	S7	188	205	XPGDWT-BS-0000-00P2E
		S6	180	196	XPGDWT-BS-0000-00N2E
		S5	172	187	XPGDWT-BS-0000-00M2E
		S4	164	179	XPGDWT-BS-0000-00L2E
3E	5000 K	S7	188	205	XPGDWT-BS-0000-00P3E
		S6	180	196	XPGDWT-BS-0000-00N3E
		S5	172	187	XPGDWT-BS-0000-00M3E
		S4	164	179	XPGDWT-BS-0000-00L3E
E3	5000 K	S7	188	205	XPGDWT-BS-0000-00PE3
		S6	180	196	XPGDWT-BS-0000-00NE3
		S5	172	187	XPGDWT-BS-0000-00ME3
		S4	164	179	XPGDWT-BS-0000-00LE3

Notes

- Cree LED maintains a tolerance of ±7% on flux and power measurements, ±0.005 on chromaticity (CCx, CCy) measurements and a tolerance of ±2 on CRI measurements. See the Measurements section (page 38).
- XLamp XP-G3 LED order codes specify only a minimum flux bin and not a maximum. Cree LED may ship reels in flux bins higher than the minimum specified by the order code without advance notice. Shipments will always adhere to the chromaticity bin restrictions specified by the order code.
- * Flux values @ 25 °C are calculated and for reference only.

ORDER CODES SUGGESTED FOR NEW DESIGNS - WHITE (S LINE) - T_J = 85 °C (CONTINUED)

Chromaticity		Minimum Luminous Flux (lm) @ 350 mA			Order Codes
Kit	CCT	Code	Flux (lm) @ 85 °C	Flux (lm) @ 25 °C*	70 CRI Minimum
4E	4500 K	S6	180	196	XPGDWT-BS-0000-00N4E
		S5	172	187	XPGDWT-BS-0000-00M4E
		S4	164	179	XPGDWT-BS-0000-00L4E
E4	4500 K	S6	180	196	XPGDWT-BS-0000-00NE4
		S5	172	187	XPGDWT-BS-0000-00ME4
		S4	164	179	XPGDWT-BS-0000-00LE4
5E	4000 K	S7	188	205	XPGDWT-BS-0000-00P5E
		S6	180	196	XPGDWT-BS-0000-00N5E
		S5	172	187	XPGDWT-BS-0000-00M5E
		S4	164	179	XPGDWT-BS-0000-00L5E
E5	4000 K	S7	188	205	XPGDWT-BS-0000-00PE5
		S6	180	196	XPGDWT-BS-0000-00NE5
		S5	172	187	XPGDWT-BS-0000-00ME5
		S4	164	179	XPGDWT-BS-0000-00LE5
6E	3500 K	S5	172	187	XPGDWT-BS-0000-00M6E
		S4	164	179	XPGDWT-BS-0000-00L6E
E6	3500 K	S5	172	187	XPGDWT-BS-0000-00ME6
		S4	164	179	XPGDWT-BS-0000-00LE6
F7	3200K	S5	172	187	XPGDWT-BS-0000-00MF7
		S4	164	179	XPGDWT-BS-0000-00LF7
7E	3000 K	S5	172	187	XPGDWT-BS-0000-00M7E
		S4	164	te	XPGDWT-BS-0000-00L7E
E7	3000 K	S5	172	187	XPGDWT-BS-0000-00ME7
		S4	164	179	XPGDWT-BS-0000-00LE7

Notes

- Cree LED maintains a tolerance of ±7% on flux and power measurements, ±0.005 on chromaticity (CCx, CCy) measurements and a tolerance of ±2 on CRI measurements. See the Measurements section (page 38).
- XLamp XP-G3 LED order codes specify only a minimum flux bin and not a maximum. Cree LED may ship reels in flux bins higher than the minimum specified by the order code without advance notice. Shipments will always adhere to the chromaticity bin restrictions specified by the order code.
- * Flux values @ 25 °C are calculated and for reference only.

FLUX CHARACTERISTICS - COLOR (STANDARD) - T_J = 25 °C

The following table provides the order code for XLamp XP-G3 color (Standard) LEDs. For a complete description of the order code nomenclature, please see the Bin and Order Code Formats section (page 36).

Color	PWL Kit Code	Peak Wavelength Range				Typical Dominant Wavelength (nm) @ 350 mA, T _J =25 °C	Minimum Radiant Flux (mW) @ 350 mA,		Calculated Minimum PPF (μmol/s) @ 350 mA, 25 °C	Order Code
		Minimum		Maximum			Code	Flux (mW) @25 °C		
		Group	PWL (nm)	Group	PWL (nm)					
Royal Blue	01	H26	440	H47	455	451	E4	635	2.41	XPGDRY-L1-0000-00401
							F2	680	2.58	XPGDRY-L1-0000-00501
							F4	730	2.77	XPGDRY-L1-0000-00601

Color	PWL Kit Code	Peak Wavelength Range				Typical Dominant Wavelength (nm) @ 350 mA, T _J =25 °C	Minimum Radiant Flux (mW) @ 350 mA,		Calculated Minimum PPF (μmol/s) @ 350 mA, 25 °C	Order Code
		Minimum		Maximum			Code	Flux (mW) @25 °C		
		Group	PWL (nm)	Group	PWL (nm)					
Photo Red (Standard)	01	P2	650	P5	670	645	31	475	2.58	XPGDPR-L1-0000-00E01
		P2	650	P5	670		32	500	2.72	XPGDPR-L1-0000-00F01

FLUX CHARACTERISTICS - COLOR (S LINE) - T_J = 25 °C

The following table provides the order code for XLamp XP-G3 color (S Line) LEDs. For a complete description of the order code nomenclature, please see the Bin and Order Code Formats section (page 36)

Color	PWL Kit Code	Peak Wavelength Range				Typical Dominant Wavelength (nm) @ 350 mA, T _J =25 °C	Minimum Radiant Flux (mW) @ 350 mA,		Calculated Minimum PPF (μmol/s) @ 350 mA, 25 °C	Order Code
		Minimum		Maximum			Code	Flux (mW) @25 °C		
		Group	PWL (nm)	Group	PWL (nm)					
Photo Red (S Line)	01	P2	650	P5	670	645	32	500	2.72	XPGDPR-LS-0000-00F01
		P2	650	P5	670		33	525	2.85	XPGDPR-LS-0000-00G01

Notes

- Cree LED maintains a tolerance of ±7% on flux and power measurements, ±0.005 on chromaticity (CCx, CCy) measurements and a tolerance of ±2 on CRI measurements. See the Measurements section (page 38).
- XLamp XP-G3 LED order codes specify only a minimum flux bin and not a maximum. Cree LED may ship reels in flux bins higher than the minimum specified by the order code without advance notice. Shipments will always adhere to the chromaticity bin restrictions specified by the order code.
- Dominant wavelengths are calculated based on peak wavelength specifications and are for reference only.
- Calculated Photosynthetic Photon Flux (PPF) values are for reference only.

FLUX CHARACTERISTICS - BROADCAST ORDER CODES AND BINS ($T_j = 85\text{ °C}$)

The following table provides order codes for XLamp XP-G3 Broadcast LEDs. For a complete description of the order code nomenclature, please see the Bin and Order Code Formats section (page 36). For definitions of the chromaticity kits, please see the Standard Chromaticity Kits section (page 35).

Chromaticity		Minimum Luminous Flux (lm) @ 350 mA			Order Codes	
Kit	CCT	Flux Bin	Flux (lm) @ 85 °C	Flux (lm) @ 25 °C*	90 CRI Minimum 90 TLCI Minimum	95 CRI Minimum 95 TLCI Minimum
E2	5700 K	R5	139	152	XPGDWT-U1-B001-A0HE2	XPGDWT-Z1-B001-A0GE2
		R4	130	142		

Notes

- Cree LED maintains a tolerance of $\pm 7\%$ on flux and power measurements, ± 0.005 on chromaticity (CCx, CCy) measurements and a tolerance of ± 2 on CRI measurements. See the Measurements section (page 38).
- XLamp XP-G3 LED order codes specify only a minimum flux bin and not a maximum. Cree LED may ship reels in flux bins higher than the minimum specified by the order code without advance notice. Shipments will always adhere to the chromaticity bin restrictions specified by the order code.
- * Flux values @ 25 °C are calculated and for reference only.

RELATIVE SPECTRAL POWER DISTRIBUTION - WHITE (STANDARD)

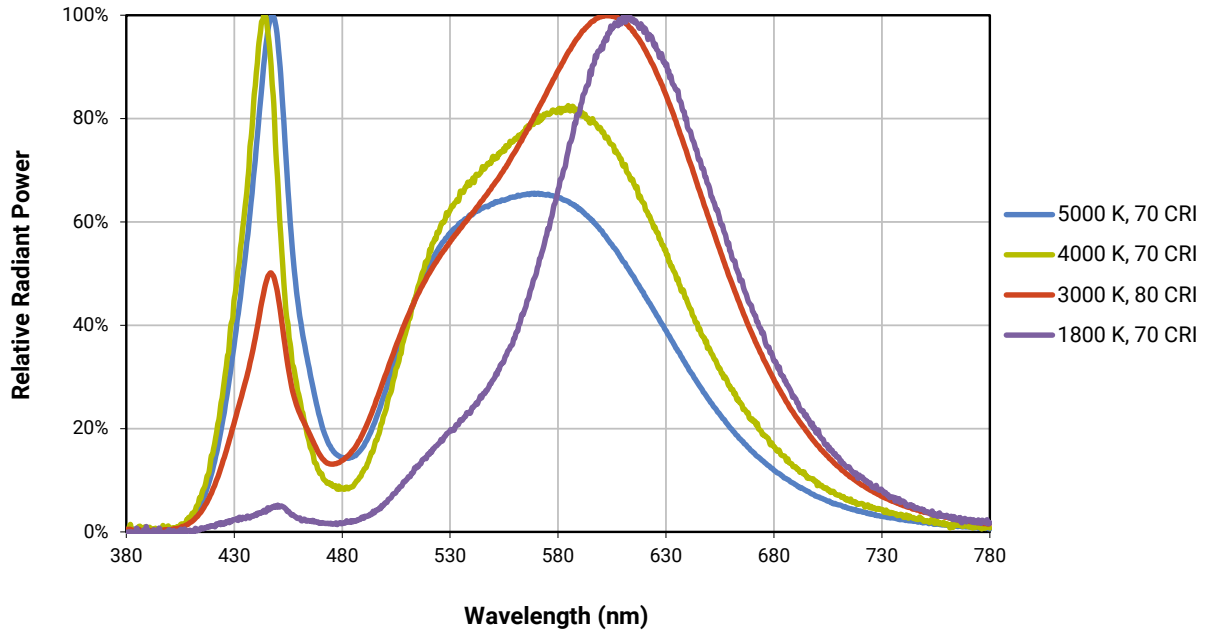

RELATIVE SPECTRAL POWER DISTRIBUTION - WHITE (S LINE)

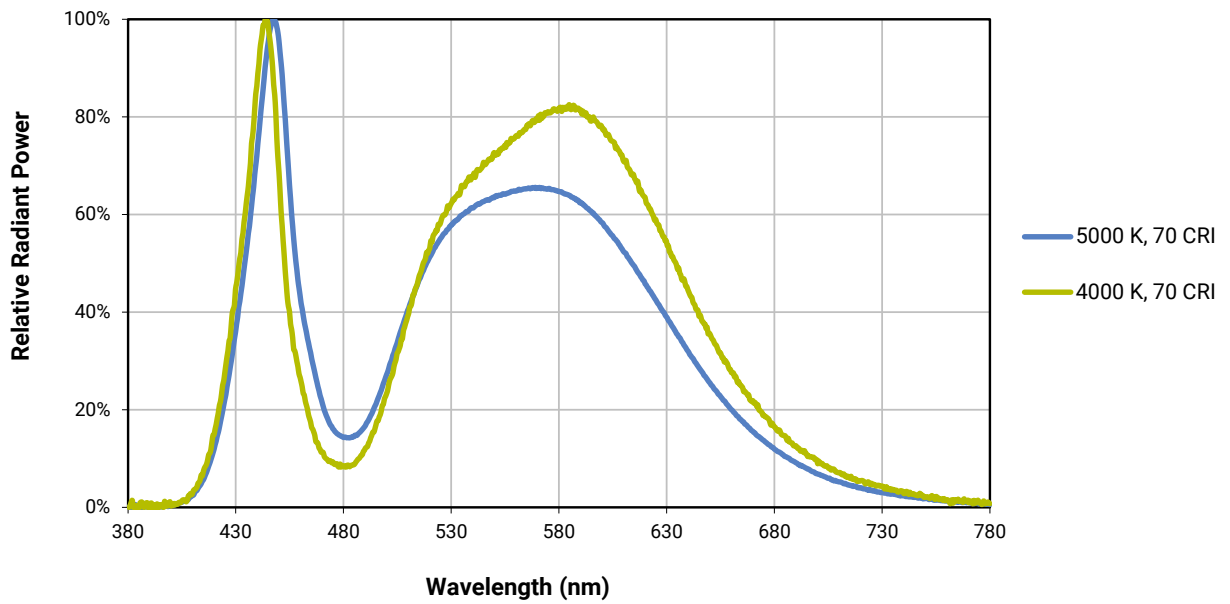

RELATIVE SPECTRAL POWER DISTRIBUTION - COLOR

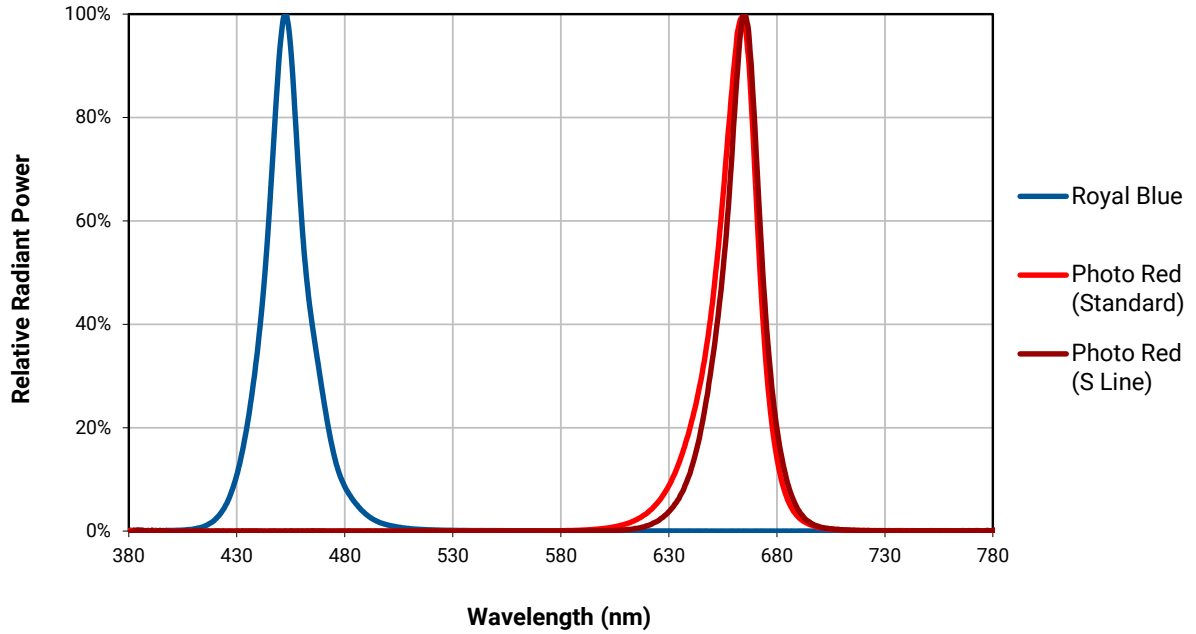

RELATIVE FLUX VS. JUNCTION TEMPERATURE - WHITE (STANDARD) - $I_f = 350 \text{ mA}$

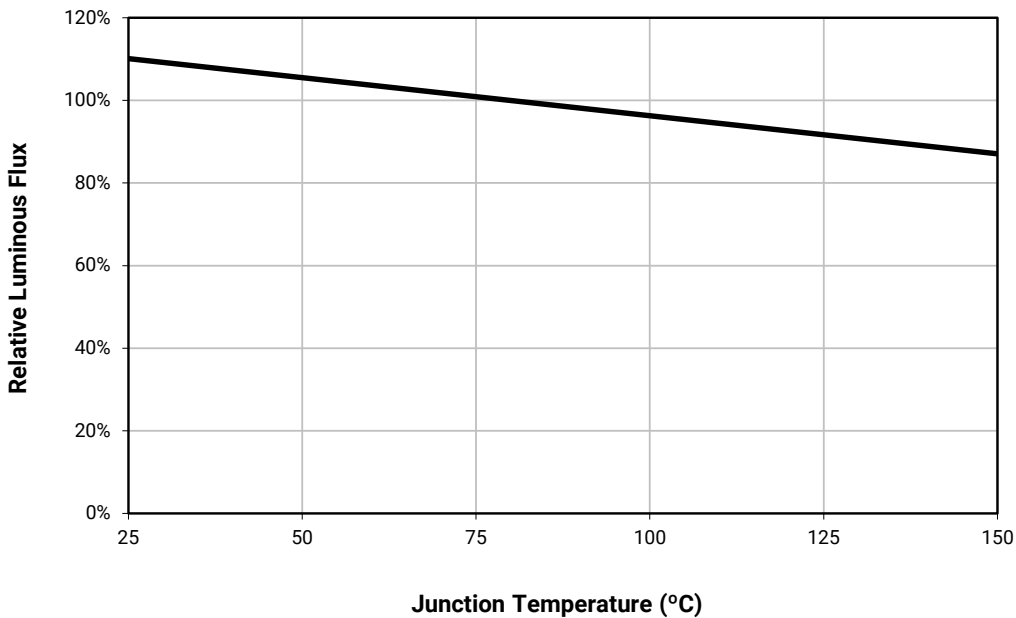

RELATIVE FLUX VS. JUNCTION TEMPERATURE - WHITE (S LINE) - $I_F = 350 \text{ mA}$

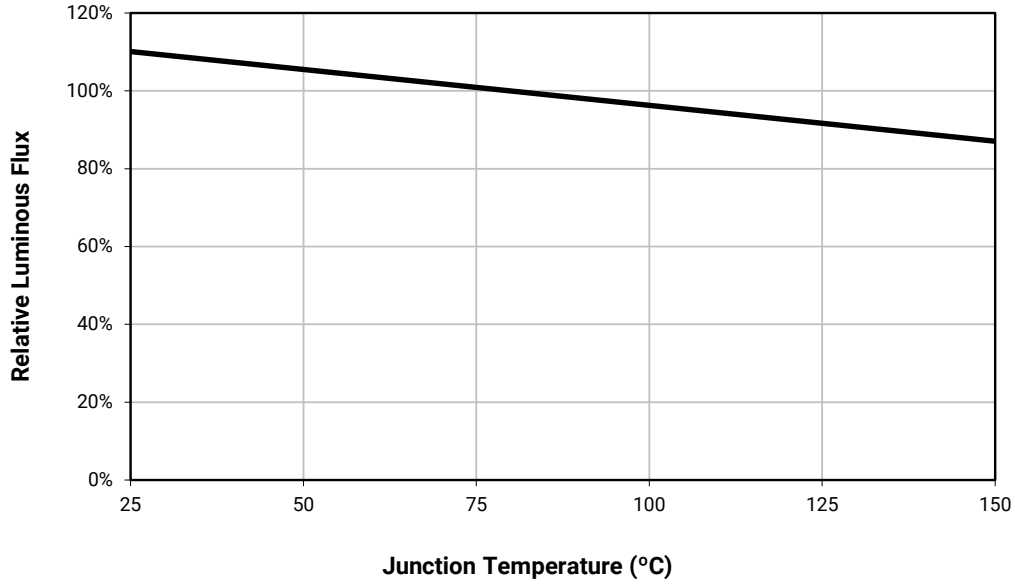

RELATIVE FLUX VS. JUNCTION TEMPERATURE - COLOR - $I_F = 350 \text{ mA}$

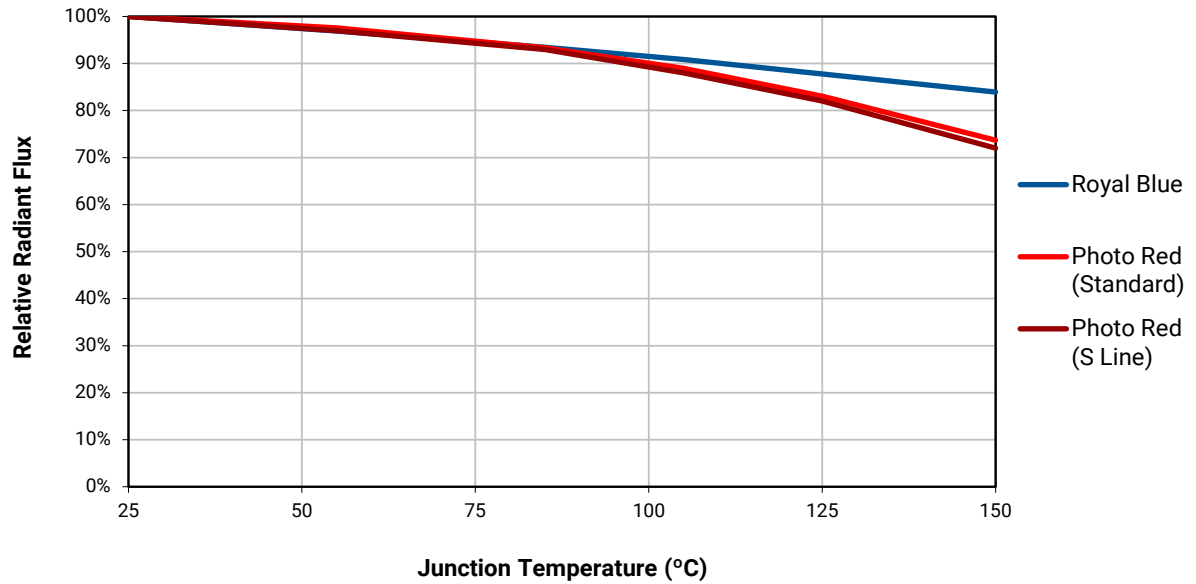

ELECTRICAL CHARACTERISTICS - WHITE (STANDARD) - $T_j = 85\text{ }^\circ\text{C}$

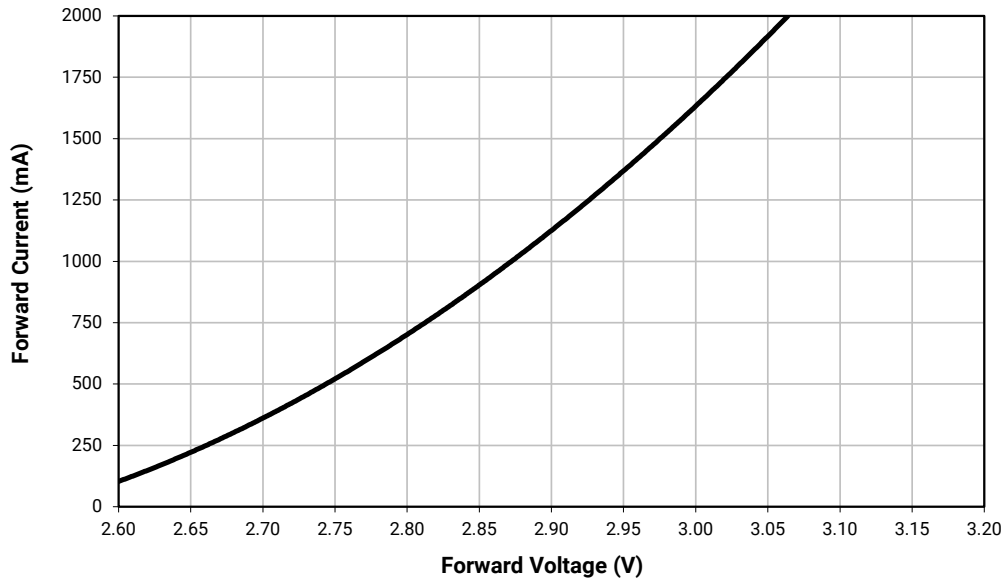

ELECTRICAL CHARACTERISTICS - WHITE (S LINE) - $T_j = 85\text{ }^\circ\text{C}$

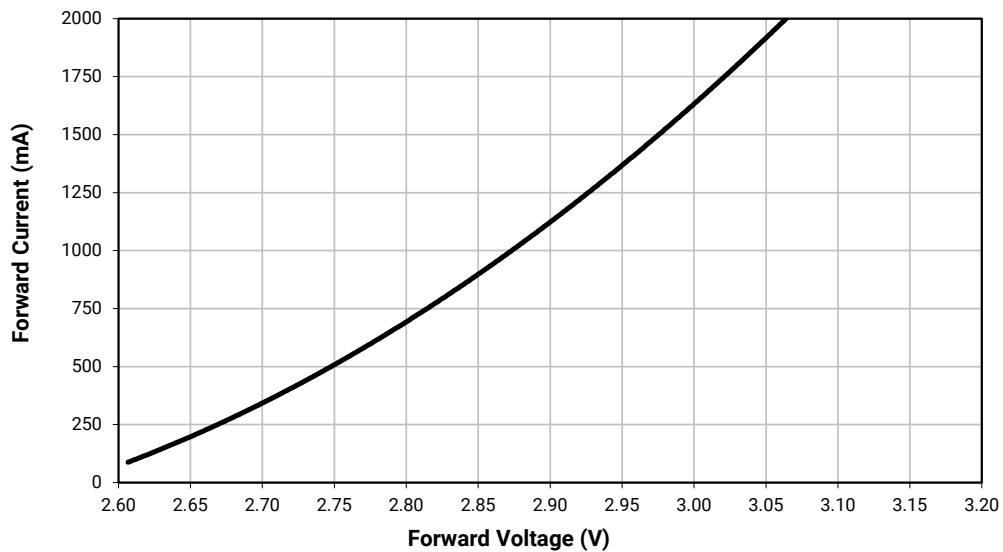

ELECTRICAL CHARACTERISTICS - COLOR ($T_j = 25\text{ }^\circ\text{C}$)

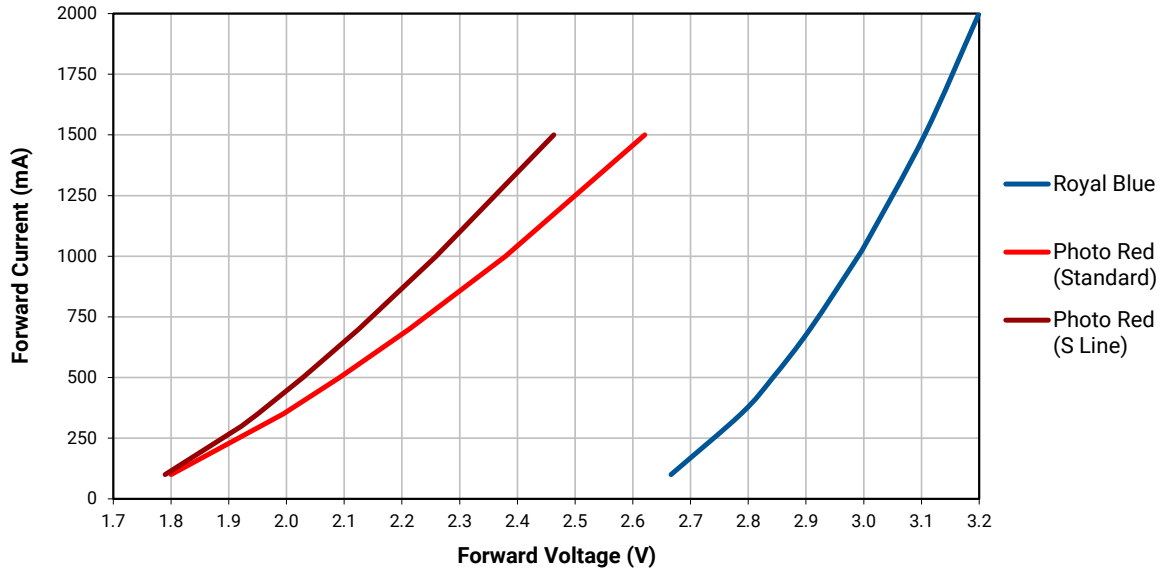

RELATIVE LUMINOUS FLUX VS. CURRENT - WHITE (STANDARD) - $T_j = 85\text{ }^\circ\text{C}$

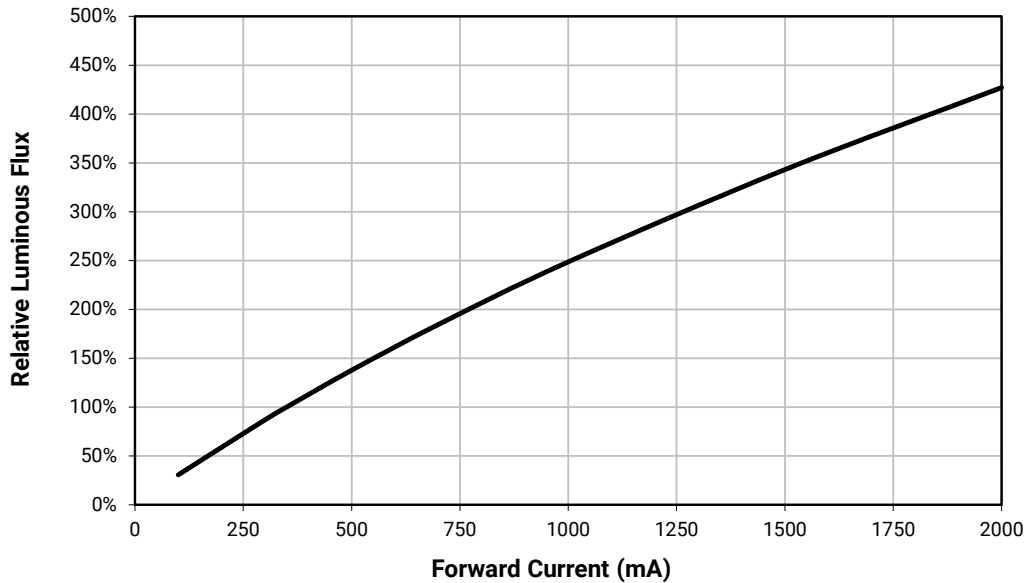

RELATIVE LUMINOUS FLUX VS. CURRENT - WHITE (S LINE) - $T_j = 85\text{ }^\circ\text{C}$

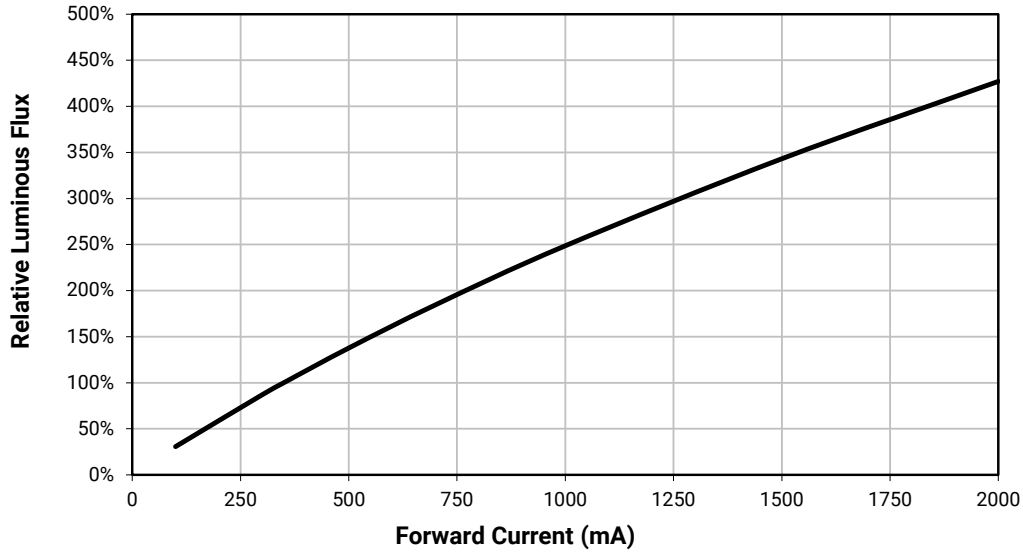

RELATIVE RADIANT FLUX VS. CURRENT - COLOR ($T_j = 25\text{ }^\circ\text{C}$)

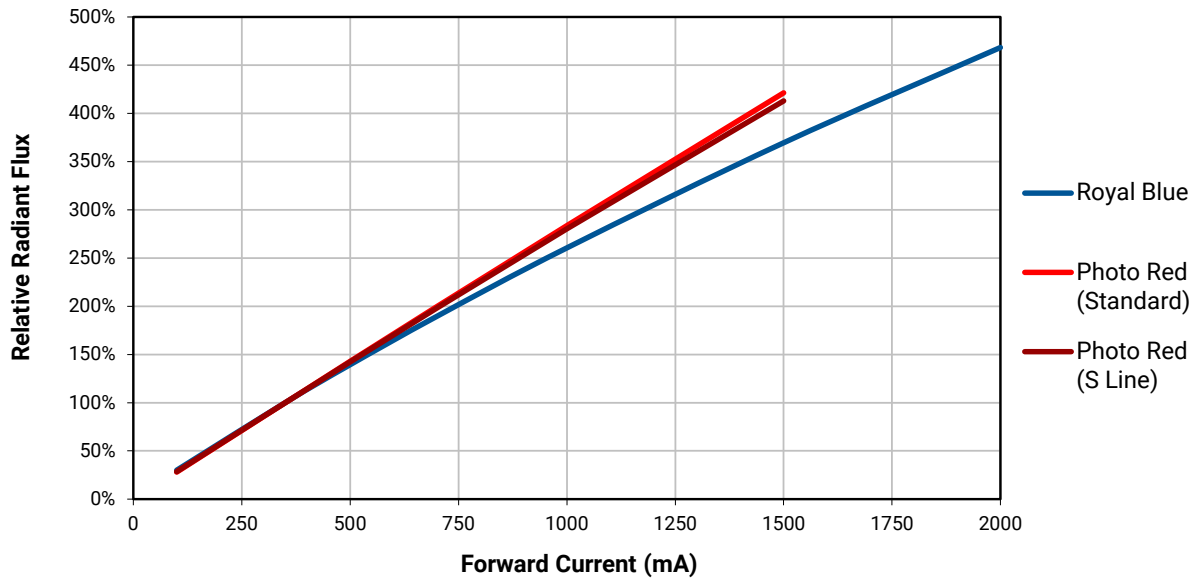

RELATIVE CHROMATICITY VS. CURRENT AND TEMPERATURE

Data shown is representative of typical XP-G3 70 CRI performance.

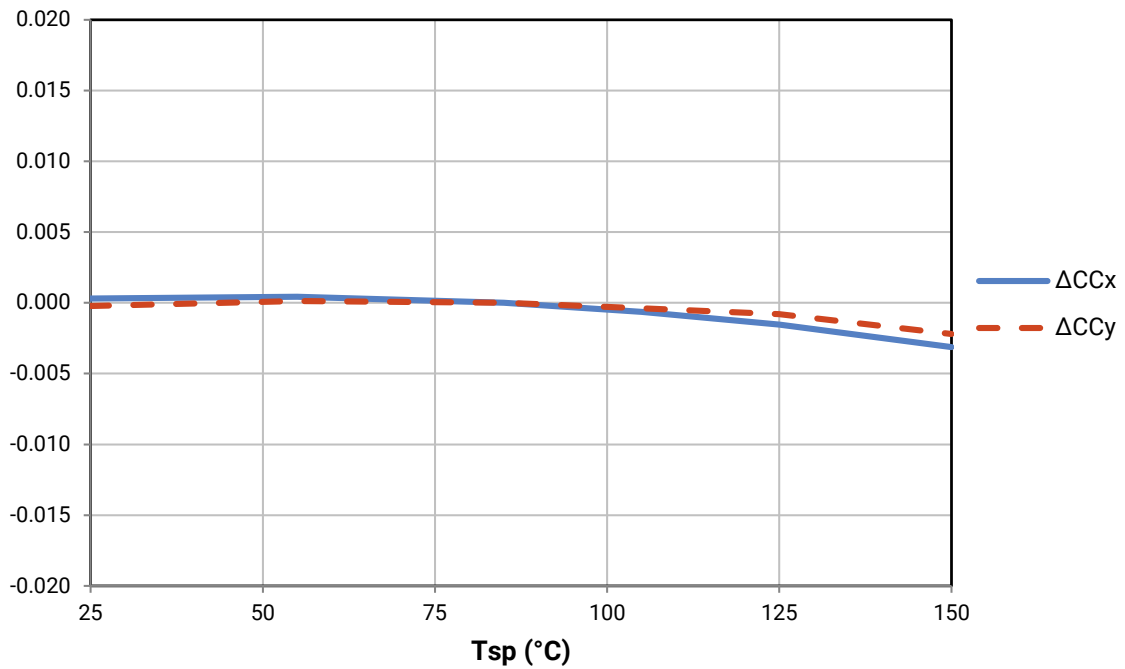
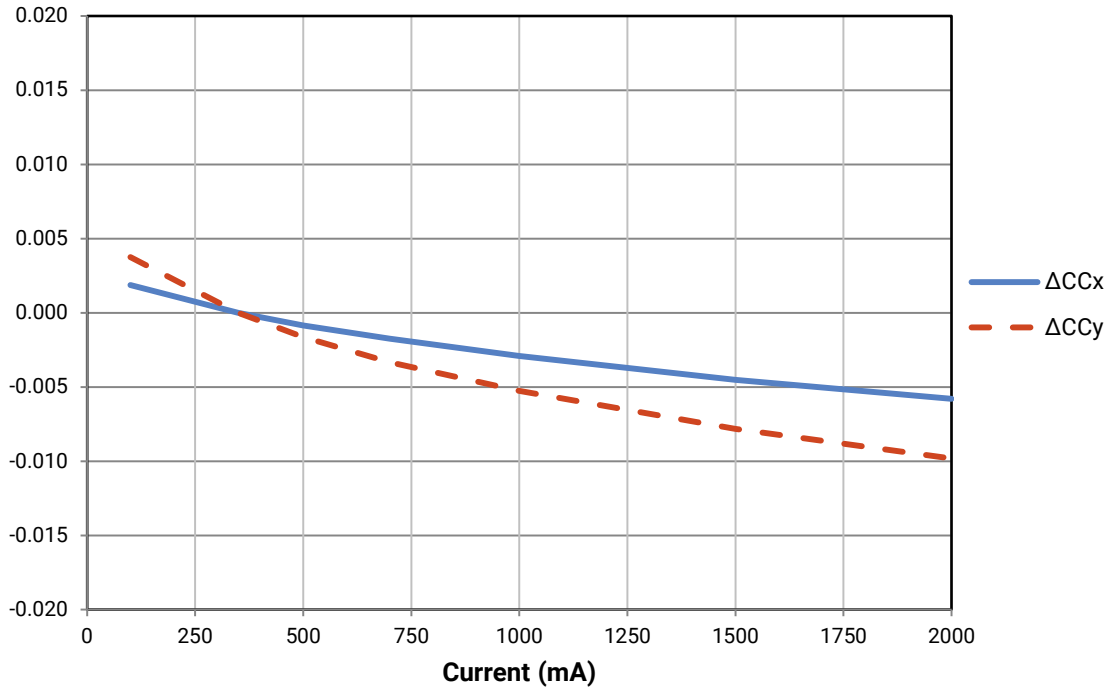

TYPICAL SPATIAL DISTRIBUTION - WHITE (STANDARD)

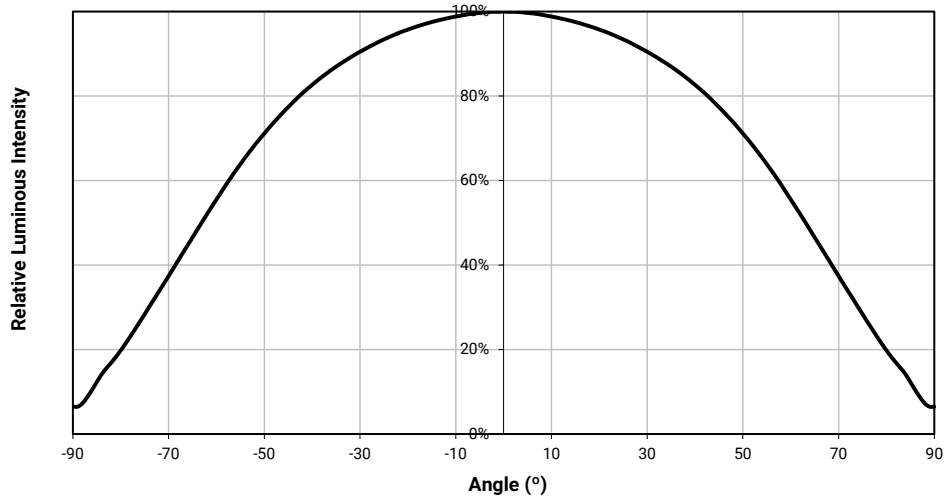

TYPICAL SPATIAL DISTRIBUTION - WHITE (S LINE)

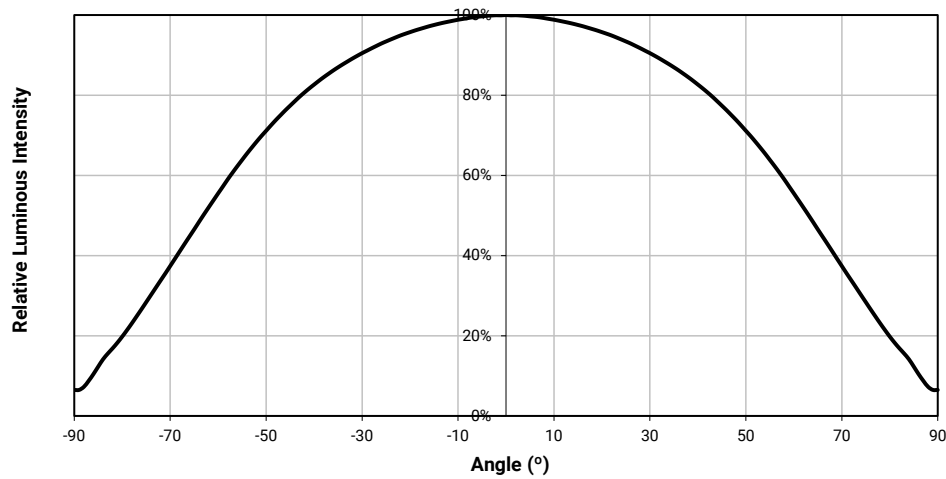

TYPICAL SPATIAL DISTRIBUTION - COLOR

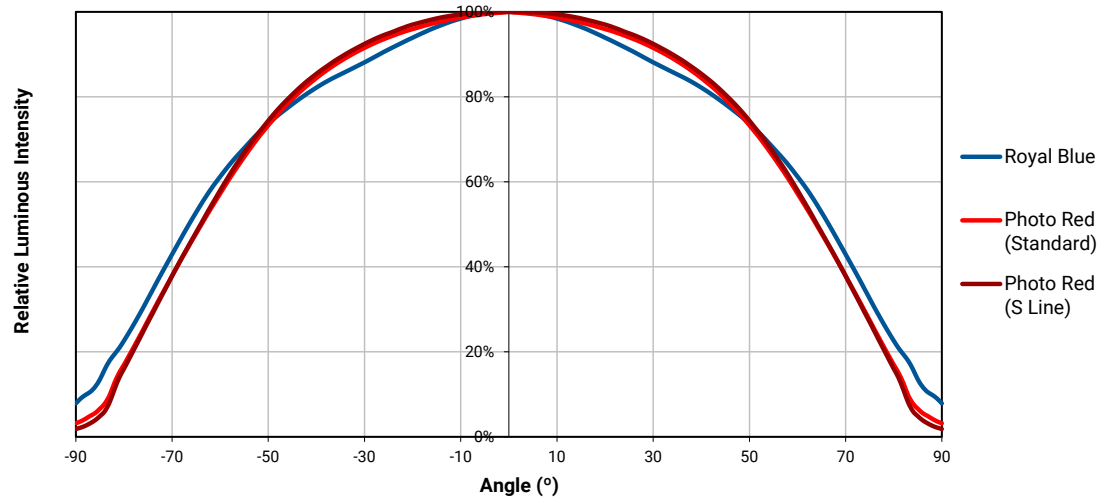

THERMAL DESIGN

The maximum forward current is determined by the thermal resistance between the LED junction and ambient. It is crucial for the end product to be designed in a manner that minimizes the thermal resistance from the solder point to ambient in order to optimize lamp life and optical characteristics.

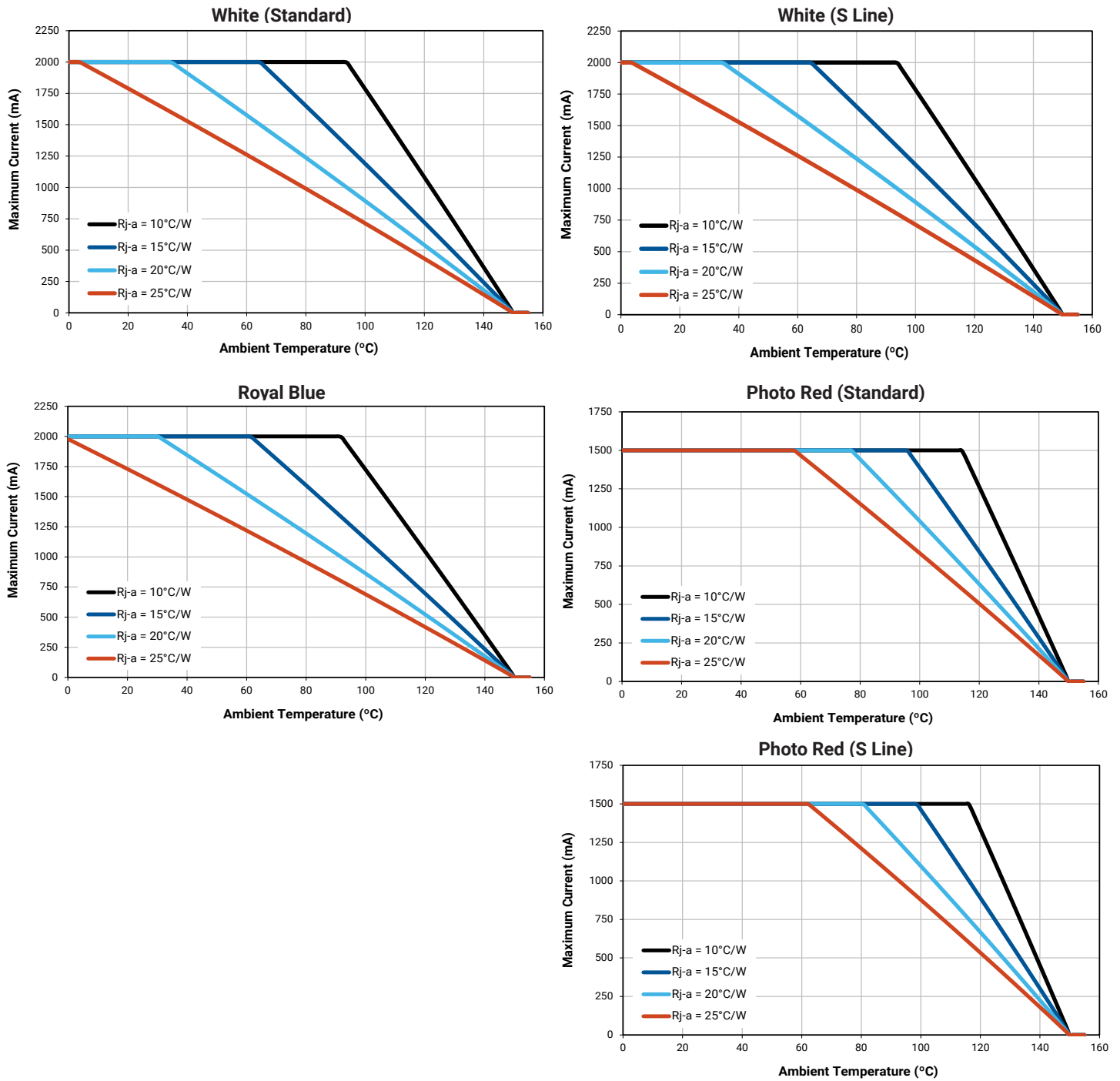

PERFORMANCE GROUPS - LUMINOUS FLUX

XLamp XP-G3 White LEDs are tested for luminous flux and placed into one of the following luminous-flux groups.

Group Code	Minimum Luminous Flux (lm) @ 350 mA	Maximum Luminous Flux (lm) @ 350 mA
Q4	100	107
Q5	107	114
R2	114	122
R3	122	130
R4	130	139
R5	139	148
S2	148	156
S3	156	164
S4	164	172
S5	172	180
S6	180	188
S7	188	196
S8	196	204

PERFORMANCE GROUPS - RADIANT FLUX ($T_j = 25\text{ }^\circ\text{C}$)

XLamp XP-G3 Royal Blue LEDs are tested for radiant flux and placed into one of the following bins.

Group Code	Minimum Radiant Flux (mW)	Maximum Radiant Flux (mW)	Calculated PPF ($\mu\text{mol/s}$)	
			Minimum	Maximum
E4	635	680	2.41	2.58
F2	680	730	2.58	2.77
F4	730	780	2.77	2.96

XLamp XP-G3 Photo Red (Standard) LEDs are tested for radiant flux and placed into one of the following bins.

Group Code	Minimum Radiant Flux (mW)	Maximum Radiant Flux (mW)	Calculated PPF ($\mu\text{mol/s}$)	
			Minimum	Maximum
31	475	500	2.58	2.72
32	500	525	2.72	2.85

XLamp XP-G3 Photo Red (S Line) LEDs are tested for radiant flux and placed into one of the following bins.

Group Code	Minimum Radiant Flux (mW)	Maximum Radiant Flux (mW)	Calculated PPF ($\mu\text{mol/s}$)	
			Minimum	Maximum
32	500	525	2.72	2.85
33	525	550	2.85	2.99

Note

- Calculated PPF values are for reference only.

PERFORMANCE GROUPS - PEAK WAVELENGTH ($T_j = 25\text{ }^\circ\text{C}$)

XLamp XP-G3 Royal Blue LEDs are tested for peak wavelength and sorted into one of the PWL bins defined below.

Group Code	Minimum Peak Wavelength (nm)	Maximum Peak Wavelength (nm)	Typical Dominant Wavelength (nm)
H26	440.0	442.5	446.5
H27	442.5	445.0	449.0
H36	445.0	447.5	451.5
H37	447.5	450.0	454.0
H46	450.0	452.5	456.5
H47	452.5	455.0	459.0

XLamp XP-G3 Photo Red LEDs are tested for peak wavelength and sorted into one of the PWL bins defined below.

Group Code	Minimum Peak Wavelength (nm)	Maximum Peak Wavelength (nm)	Typical Dominant Wavelength (nm)
P2	650	655	638
P3	655	660	643
P4	660	665	647
P5	665	670	652

Note

- Typical dominant wavelength values are calculated and for reference only.

PERFORMANCE GROUPS - FORWARD VOLTAGE

XLamp XP-G3 Photo Red LEDs are tested for forward voltage and sorted into one of the forward voltage bins defined below.

Forward Voltage Group	Minimum Forward Voltage (V) @ 350 mA	Maximum Forward Voltage (V) @ 350 mA
W	1.8	1.9
X	1.9	2.0
Y	2.0	2.1
Z	2.1	2.2

PERFORMANCE GROUPS - CHROMATICITY

Region	x	y	Region	x	y	Region	x	y	Region	x	y
0A	0.2950	0.2970	0B	0.2920	0.3060	0C	0.2984	0.3133	0D	0.2984	0.3133
	0.2920	0.3060		0.2895	0.3135		0.2962	0.3220		0.3048	0.3207
	0.2984	0.3133		0.2962	0.3220		0.3028	0.3304		0.3068	0.3113
	0.3009	0.3042		0.2984	0.3133		0.3048	0.3207		0.3009	0.3042
0R	0.2980	0.2880	0S	0.2895	0.3135	0T	0.2962	0.3220	0U	0.3037	0.2937
	0.2950	0.2970		0.2870	0.3210		0.2937	0.3312		0.3009	0.3042
	0.3009	0.3042		0.2937	0.3312		0.3005	0.3415		0.3068	0.3113
	0.3037	0.2937		0.2962	0.3220		0.3028	0.3304		0.3093	0.2993
1A	0.3048	0.3207	1B	0.3028	0.3304	1C	0.3115	0.3391	1D	0.3130	0.3290
	0.3130	0.3290		0.3115	0.3391		0.3205	0.3481		0.3213	0.3373
	0.3144	0.3186		0.3130	0.3290		0.3213	0.3373		0.3221	0.3261
	0.3068	0.3113		0.3048	0.3207		0.3130	0.3290		0.3144	0.3186
1R	0.3068	0.3113	1S	0.3005	0.3415	1T	0.3099	0.3509	1U	0.3144	0.3186
	0.3144	0.3186		0.3099	0.3509		0.3196	0.3602		0.3221	0.3261
	0.3161	0.3059		0.3115	0.3391		0.3205	0.3481		0.3231	0.3120
	0.3093	0.2993		0.3028	0.3304		0.3115	0.3391		0.3161	0.3059
2A	0.3215	0.3350	2B	0.3207	0.3462	2C	0.3290	0.3538	2D	0.3290	0.3417
	0.3290	0.3417		0.3290	0.3538		0.3376	0.3616		0.3371	0.3490
	0.3290	0.3300		0.3290	0.3417		0.3371	0.3490		0.3366	0.3369
	0.3222	0.3243		0.3215	0.3350		0.3290	0.3417		0.3290	0.3300
2R	0.3222	0.3243	2S	0.3196	0.3602	2T	0.3290	0.3690	2U	0.3290	0.3300
	0.3290	0.3300		0.3290	0.3690		0.3381	0.3762		0.3366	0.3369
	0.3290	0.3180		0.3290	0.3538		0.3376	0.3616		0.3361	0.3245
	0.3231	0.3120		0.3207	0.3462		0.3290	0.3538		0.3290	0.3180
3A	0.3371	0.3490	3B	0.3376	0.3616	3C	0.3463	0.3687	3D	0.3451	0.3554
	0.3451	0.3554		0.3463	0.3687		0.3551	0.3760		0.3533	0.3620
	0.3440	0.3427		0.3451	0.3554		0.3533	0.3620		0.3515	0.3487
	0.3366	0.3369		0.3371	0.3490		0.3451	0.3554		0.3440	0.3427
3R	0.3366	0.3369	3S	0.3381	0.3762						
	0.3440	0.3428		0.3480	0.3840						
	0.3429	0.3307		0.3463	0.3687						
	0.3361	0.3245		0.3376	0.3616						
4A	0.3530	0.3597	4B	0.3548	0.3736	4C	0.3641	0.3804	4D	0.3615	0.3659
	0.3615	0.3659		0.3641	0.3804		0.3736	0.3874		0.3702	0.3722
	0.3590	0.3521		0.3615	0.3659		0.3702	0.3722		0.3670	0.3578
	0.3512	0.3465		0.3530	0.3597		0.3615	0.3659		0.3590	0.3521

PERFORMANCE GROUPS - CHROMATICITY (CONTINUED)

Region	x	y	Region	x	y	Region	x	y	Region	x	y
5A1	0.3670	0.3578	5A2	0.3686	0.3649	5A3	0.3744	0.3685	5A4	0.3726	0.3612
	0.3686	0.3649		0.3702	0.3722		0.3763	0.3760		0.3744	0.3685
	0.3744	0.3685		0.3763	0.3760		0.3825	0.3798		0.3804	0.3721
	0.3726	0.3612		0.3744	0.3685		0.3804	0.3721		0.3783	0.3646
5B1	0.3702	0.3722	5B2	0.3719	0.3797	5B3	0.3782	0.3837	5B4	0.3763	0.3760
	0.3719	0.3797		0.3736	0.3874		0.3802	0.3916		0.3782	0.3837
	0.3782	0.3837		0.3802	0.3916		0.3869	0.3958		0.3847	0.3877
	0.3763	0.3760		0.3782	0.3837		0.3847	0.3877		0.3825	0.3798
5C1	0.3825	0.3798	5C2	0.3847	0.3877	5C3	0.3912	0.3917	5C4	0.3887	0.3836
	0.3847	0.3877		0.3869	0.3958		0.3937	0.4001		0.3912	0.3917
	0.3912	0.3917		0.3937	0.4001		0.4006	0.4044		0.3978	0.3958
	0.3887	0.3836		0.3912	0.3917		0.3978	0.3958		0.3950	0.3875
5D1	0.3783	0.3646	5D2	0.3804	0.3721	5D3	0.3863	0.3758	5D4	0.3840	0.3681
	0.3804	0.3721		0.3825	0.3798		0.3887	0.3836		0.3863	0.3758
	0.3863	0.3758		0.3887	0.3836		0.3950	0.3875		0.3924	0.3794
	0.3840	0.3681		0.3863	0.3758		0.3924	0.3794		0.3898	0.3716
6A1	0.3889	0.3690	6A2	0.3915	0.3768	6A3	0.3981	0.3800	6A4	0.3953	0.3720
	0.3915	0.3768		0.3941	0.3848		0.4010	0.3882		0.3981	0.3800
	0.3981	0.3800		0.4010	0.3882		0.4080	0.3916		0.4048	0.3832
	0.3953	0.3720		0.3981	0.3800		0.4048	0.3832		0.4017	0.3751
6B1	0.3941	0.3848	6B2	0.3968	0.3930	6B3	0.4040	0.3966	6B4	0.4010	0.3882
	0.3968	0.3930		0.3996	0.4015		0.4071	0.4052		0.4040	0.3966
	0.4040	0.3966		0.4071	0.4052		0.4146	0.4089		0.4113	0.4001
	0.4010	0.3882		0.4040	0.3966		0.4113	0.4001		0.4080	0.3916
6C1	0.4080	0.3916	6C2	0.4113	0.4001	6C3	0.4186	0.4037	6C4	0.4150	0.3950
	0.4113	0.4001		0.4146	0.4089		0.4222	0.4127		0.4186	0.4037
	0.4186	0.4037		0.4222	0.4127		0.4299	0.4165		0.4259	0.4073
	0.4150	0.3950		0.4186	0.4037		0.4259	0.4073		0.4221	0.3984
6D1	0.4017	0.3751	6D2	0.4048	0.3832	6D3	0.4116	0.3865	6D4	0.4082	0.3782
	0.4048	0.3832		0.4080	0.3916		0.4150	0.3950		0.4116	0.3865
	0.4116	0.3865		0.4150	0.3950		0.4221	0.3984		0.4183	0.3898
	0.4082	0.3782		0.4116	0.3865		0.4183	0.3898		0.4147	0.3814
7A1	0.4147	0.3814	7A2	0.4183	0.3898	7A3	0.4242	0.3919	7A4	0.4203	0.3833
	0.4183	0.3898		0.4221	0.3984		0.4281	0.4006		0.4242	0.3919
	0.4242	0.3919		0.4281	0.4006		0.4342	0.4028		0.4300	0.3939
	0.4203	0.3833		0.4242	0.3919		0.4300	0.3939		0.4259	0.3853

PERFORMANCE GROUPS - CHROMATICITY (CONTINUED)

Region	x	y	Region	x	y	Region	x	y	Region	x	y
7B1	0.4221	0.3984	7B2	0.4259	0.4073	7B3	0.4322	0.4096	7B4	0.4281	0.4006
	0.4259	0.4073		0.4299	0.4165		0.4364	0.4188		0.4322	0.4096
	0.4322	0.4096		0.4364	0.4188		0.4430	0.4212		0.4385	0.4119
	0.4281	0.4006		0.4322	0.4096		0.4385	0.4119		0.4342	0.4028
7C1	0.4342	0.4028	7C2	0.4385	0.4119	7C3	0.4449	0.4141	7C4	0.4403	0.4049
	0.4385	0.4119		0.4430	0.4212		0.4496	0.4236		0.4449	0.4141
	0.4449	0.4141		0.4496	0.4236		0.4562	0.4260		0.4513	0.4164
	0.4403	0.4049		0.4449	0.4141		0.4513	0.4164		0.4465	0.4071
7D1	0.4259	0.3853	7D2	0.4300	0.3939	7D3	0.4359	0.3960	7D4	0.4316	0.3873
	0.4300	0.3939		0.4342	0.4028		0.4403	0.4049		0.4359	0.3960
	0.4359	0.3960		0.4403	0.4049		0.4465	0.4071		0.4418	0.3981
	0.4316	0.3873		0.4359	0.3960		0.4418	0.3981		0.4373	0.3893
8A1	0.4373	0.3893	8A2	0.4418	0.3981	8A3	0.4475	0.3994	8A4	0.4428	0.3906
	0.4418	0.3981		0.4465	0.4071		0.4523	0.4085		0.4475	0.3994
	0.4475	0.3994		0.4523	0.4085		0.4582	0.4099		0.4532	0.4008
	0.4428	0.3906		0.4475	0.3994		0.4532	0.4008		0.4483	0.3919
8B1	0.4465	0.4071	8B2	0.4513	0.4164	8B3	0.4573	0.4178	8B4	0.4523	0.4085
	0.4513	0.4164		0.4562	0.4260		0.4624	0.4274		0.4573	0.4178
	0.4573	0.4178		0.4624	0.4274		0.4687	0.4289		0.4634	0.4193
	0.4523	0.4085		0.4573	0.4178		0.4634	0.4193		0.4582	0.4099
8C1	0.4582	0.4099	8C2	0.4634	0.4193	8C3	0.4695	0.4207	8C4	0.4641	0.4112
	0.4634	0.4193		0.4687	0.4289		0.4750	0.4304		0.4695	0.4207
	0.4695	0.4207		0.4750	0.4304		0.4813	0.4319		0.4756	0.4221
	0.4641	0.4112		0.4695	0.4207		0.4756	0.4221		0.4700	0.4126
8D1	0.4483	0.3919	8D2	0.4532	0.4008	8D3	0.4589	0.4021	8D4	0.4538	0.3931
	0.4532	0.4008		0.4582	0.4099		0.4641	0.4112		0.4589	0.4021
	0.4589	0.4021		0.4641	0.4112		0.4700	0.4126		0.4646	0.4034
	0.4538	0.3931		0.4589	0.4021		0.4646	0.4034		0.4593	0.3944
AA1	0.4822	0.3973	AA2	0.4884	0.4067	AA3	0.4942	0.4066	AA4	0.4879	0.3972
	0.4884	0.4067		0.4946	0.4162		0.5006	0.4160		0.4942	0.4066
	0.4942	0.4066		0.5006	0.4160		0.5066	0.4158		0.5001	0.4064
	0.4879	0.3972		0.4942	0.4066		0.5001	0.4064		0.4936	0.3970
AB1	0.4946	0.4162	AB2	0.5008	0.4256	AB3	0.5069	0.4254	AB4	0.5006	0.4160
	0.5008	0.4256		0.5070	0.4350		0.5133	0.4348		0.5069	0.4254
	0.5069	0.4254		0.5133	0.4348		0.5196	0.4346		0.5131	0.4252
	0.5006	0.4160		0.5069	0.4254		0.5131	0.4252		0.5066	0.4158

PERFORMANCE GROUPS - CHROMATICITY (CONTINUED)

Region	x	y	Region	x	y	Region	x	y	Region	x	y
AC1	0.5066	0.4158	AC2	0.5131	0.4252	AC3	0.5192	0.4250	AC4	0.5126	0.4156
	0.5131	0.4252		0.5196	0.4346		0.5258	0.4343		0.5192	0.4250
	0.5192	0.4250		0.5258	0.4343		0.5321	0.4341		0.5253	0.4248
	0.5126	0.4156		0.5192	0.4250		0.5253	0.4248		0.5186	0.4154
AD1	0.4936	0.3970	AD2	0.5001	0.4064	AD3	0.5059	0.4062	AD4	0.4993	0.3969
	0.5001	0.4064		0.5066	0.4158		0.5126	0.4156		0.5059	0.4062
	0.5059	0.4062		0.5126	0.4156		0.5186	0.4154		0.5118	0.4061
	0.4993	0.3969		0.5059	0.4062		0.5118	0.4061		0.5050	0.3967

XLamp XP-G3 White LEDs are tested for chromaticity and placed into one of the regions defined by the following bounding coordinates.

EasyWhite Color Temperatures – 3-Step Ellipse						
Bin Code	CCT	Center Point		Major Axis	Minor Axis	Rotation Angle (°)
		x	y	a	b	
6G	3500 K	0.4073	0.3917	0.00927	0.00414	53.2
7G	3000 K	0.4338	0.4030	0.00834	0.00408	53.2
8G	2700 K	0.4577	0.4099	0.00834	0.00420	48.5

EasyWhite Color Temperatures – 5-Step Ellipse						
Bin Code	CCT	Center Point		Major Axis	Minor Axis	Rotation Angle (°)
		x	y	a	b	
2E	5700 K	0.3287	0.3417	0.01230	0.00600	72.0
3E	5000 K	0.3447	0.3553	0.01400	0.00520	65.0
4E	4500 K	0.3611	0.3658	0.01420	0.00550	61.5
5E	4000 K	0.3818	0.3797	0.01565	0.00670	53.7
6E	3500 K	0.4073	0.3917	0.01545	0.00690	54.0
7E	3000 K	0.4338	0.4030	0.01390	0.00680	53.2
8E	2700 K	0.4577	0.4099	0.01350	0.00700	48.5
BE	1800 K	0.5492	0.4082	0.00683	0.01546	-40.0

STANDARD COOL WHITE KITS PLOTTED ON ANSI STANDARD CHROMATICITY REGIONS

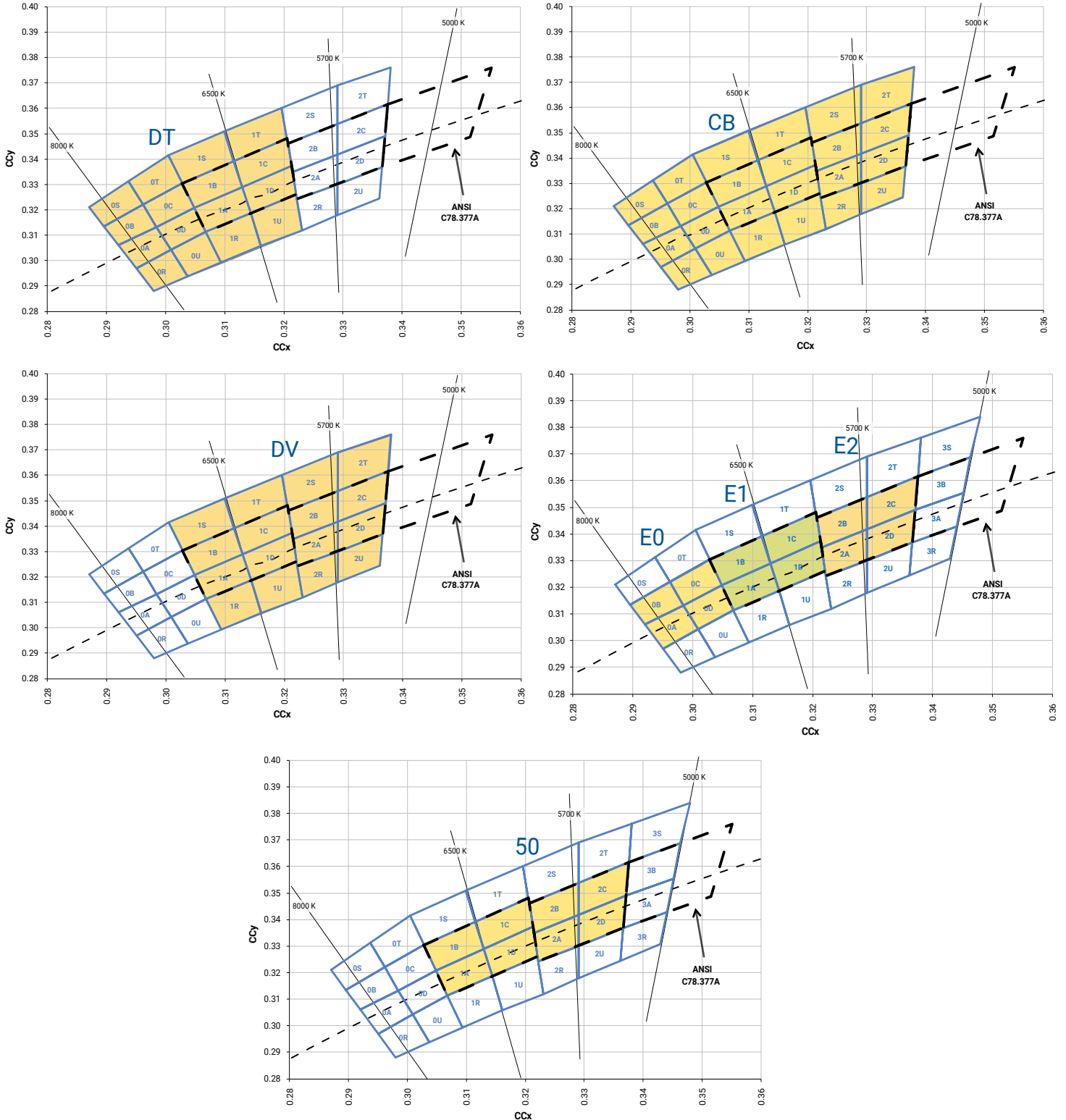

STANDARD WARM AND NEUTRAL WHITE KITS PLOTTED ON ANSI STANDARD CHROMATICITY REGIONS

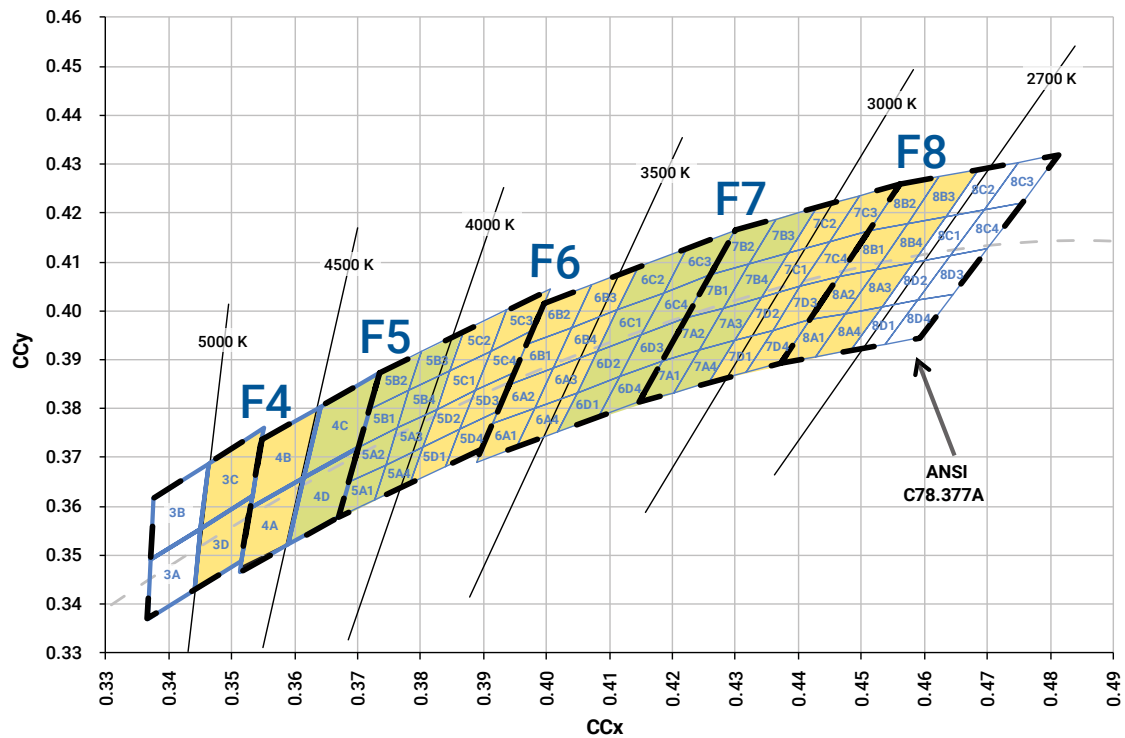
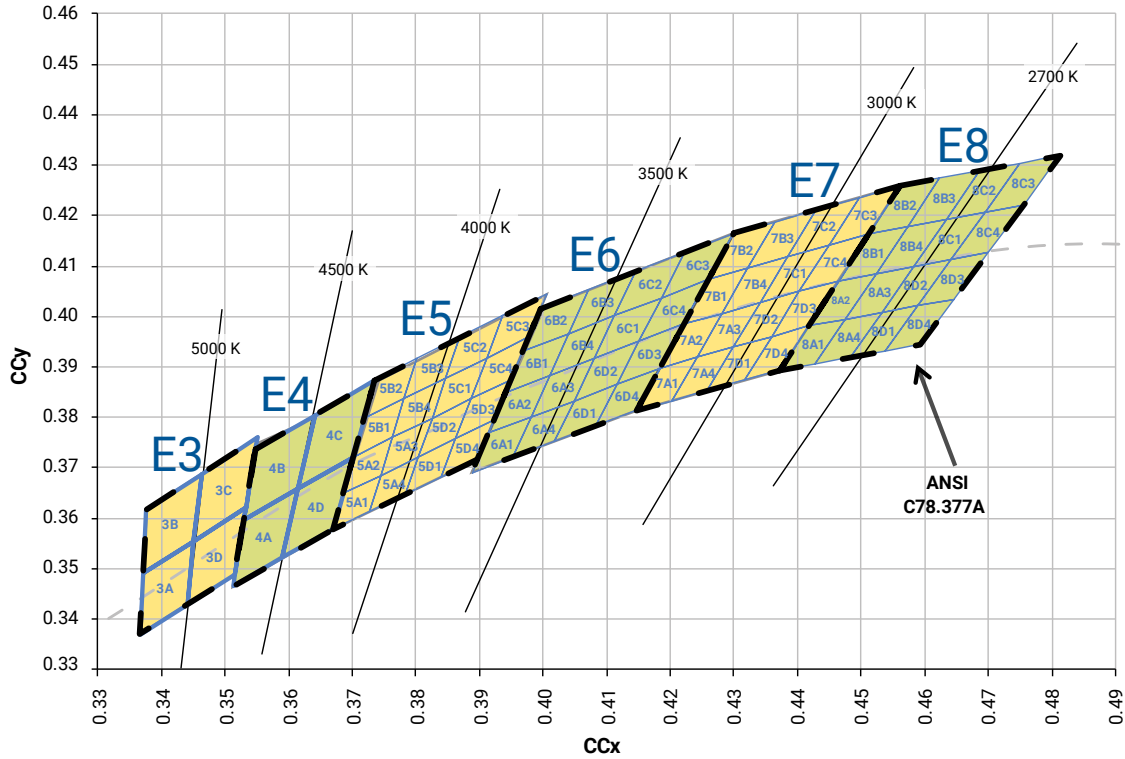

STANDARD WARM AND NEUTRAL WHITE KITS PLOTTED ON ANSI STANDARD CHROMATICITY REGIONS - CONTINUED

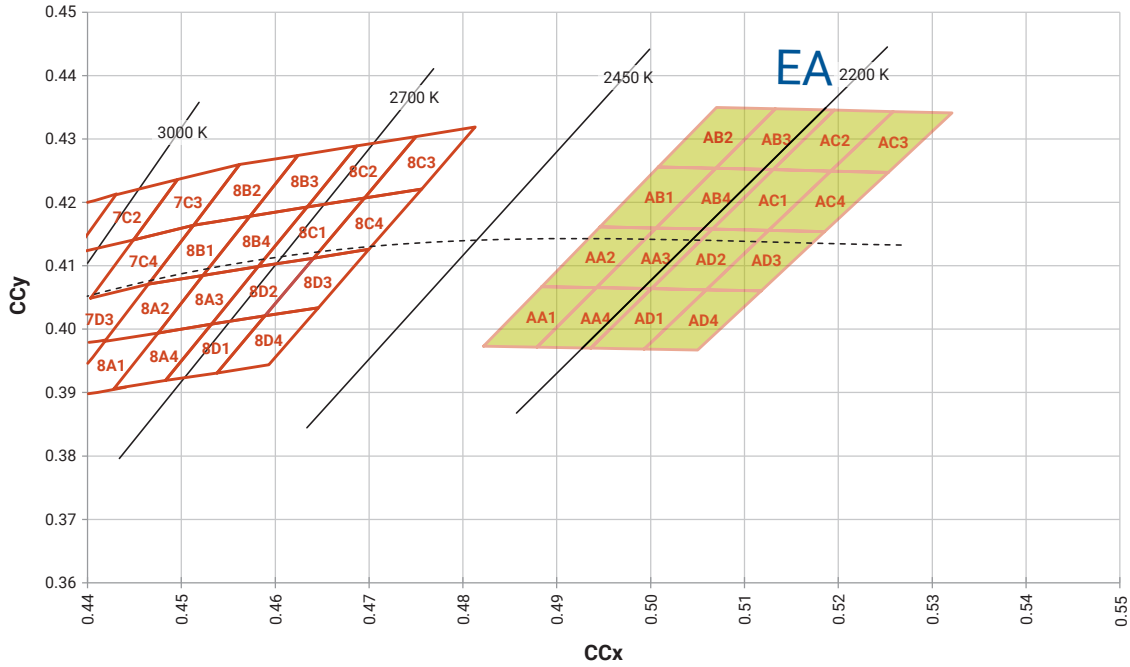

EASYWHITE® WHITE KITS PLOTTED ON ANSI STANDARD CHROMATICITY REGIONS

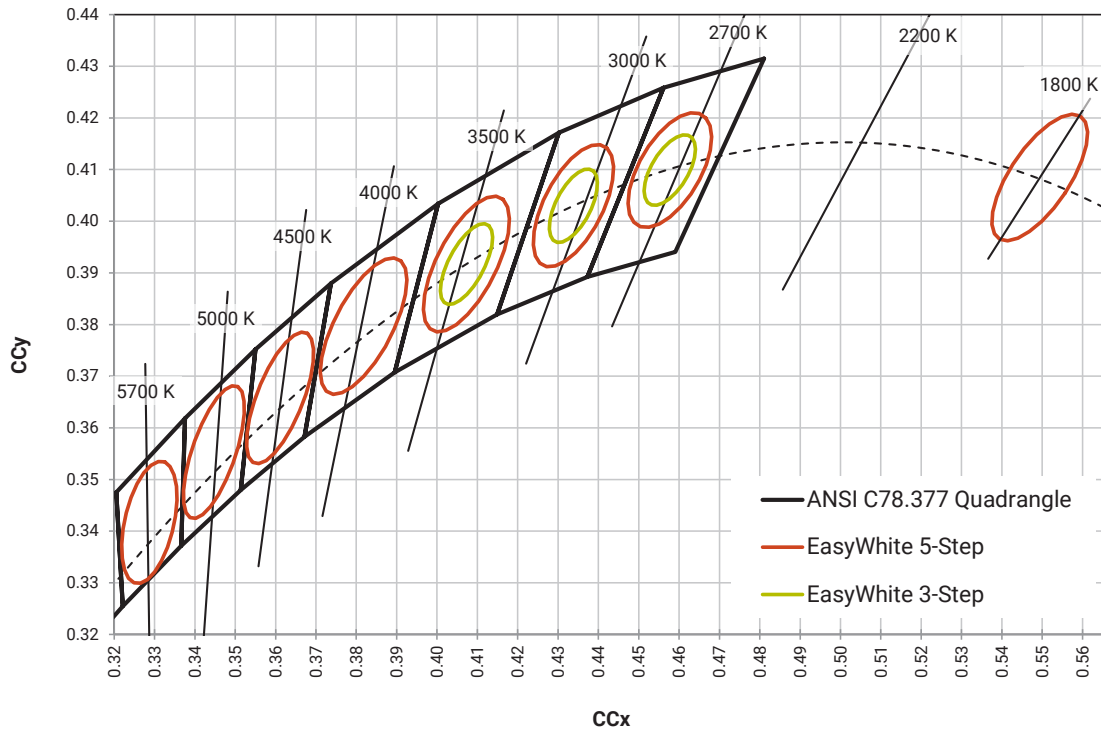

STANDARD CHROMATICITY KITS

The following table provides the chromaticity bins associated with chromaticity kits.

Color	CCT	Kit	Chromaticity Bins
Cool White	7000 K	DT	0A, 0B, 0C, 0D, 0R, 0S, 0T, 0U, 1A, 1B, 1C, 1D, 1R, 1S, 1T, 1U
	6500 K	CB	0A, 0B, 0C, 0D, 0R, 0S, 0T, 0U, 1A, 1B, 1C, 1D, 1R, 1S, 1T, 1U, 2A, 2B, 2C, 2D, 2R, 2S, 2T, 2U
	>6500 K	E0	0A, 0B, 0C, 0D
	6500 K	E1	1A, 1B, 1C, 1D
	6000 K	DV	1A, 1B, 1C, 1D, 1R, 1S, 1T, 1U, 2A, 2B, 2C, 2D, 2R, 2S, 2T, 2U
	6200 K	50	1A, 1B, 1C, 1D, 2A, 2B, 2C, 2D
	5700 K	E2	2A, 2B, 2C, 2D
	5700 K	2E	57E
Neutral White	5000 K	3E	50E
	5000 K	E3	3A, 3B, 3C, 3D
	4750 K	F4	3C, 3D, 4A, 4B
	4500 K	4E	45E
	4500 K	E4	4A, 4B, 4C, 4D
	4250 K	F5	4C, 4D, 5A1, 5A2, 5A3, 5A4, 5B1, 5B2, 5B3, 5B4
	4000 K	5E	40E
	4000 K	E5	5A1, 5A2, 5A3, 5A4, 5B1, 5B2, 5B3, 5B4, 5C1, 5C2, 5C3, 5C4, 5D1, 5D2, 5D3, 5D4
Warm White	3750 K	F6	5C1, 5C2, 5C3, 5C4, 5D1, 5D2, 5D3, 5D4, 6A1, 6A2, 6A3, 6A4, 6B1, 6B2, 6B3, 6B4
	3500 K	6E	35E, 35G
	3500 K	6G	35G
	3500 K	E6	6A1, 6A2, 6A3, 6A4, 6B1, 6B2, 6B3, 6B4, 6C1, 6C2, 6C3, 6C4, 6D1, 6D2, 6D3, 6D4
	3250 K	F7	6C1, 6C2, 6C3, 6C4, 6D1, 6D2, 6D3, 6D4, 7A1, 7A2, 7A3, 7A4, 7B1, 7B2, 7B3, 7B4
	3000 K	7E	30E, 30G
	3000 K	7G	30G
	3000 K	E7	7A1, 7A2, 7A3, 7A4, 7B1, 7B2, 7B3, 7B4, 7C1, 7C2, 7C3, 7C4, 7D1, 7D2, 7D3, 7D4
	2850 K	F8	7C1, 7C2, 7C3, 7C4, 7D1, 7D2, 7D3, 7D4, 8A1, 8A2, 8A3, 8A4, 8B1, 8B2, 8B3, 8B4
	2700 K	8E	27E, 27G
	2700 K	8G	27G
	2700 K	E8	8A1, 8A2, 8A3, 8A4, 8B1, 8B2, 8B3, 8B4, 8C1, 8C2, 8C3, 8C4, 8D1, 8D2, 8D3, 8D4
	2200 K	EA	AA1, AA2, AA3, AA4, AB1, AB2, AB3, AB4, AC1, AC2, AC3, AC4, AD1, AD2, AD3, AD4
	1800 K	BE	18E

BIN AND ORDER CODE FORMATS

XP-G3 bin codes and order codes are configured in the following manner:

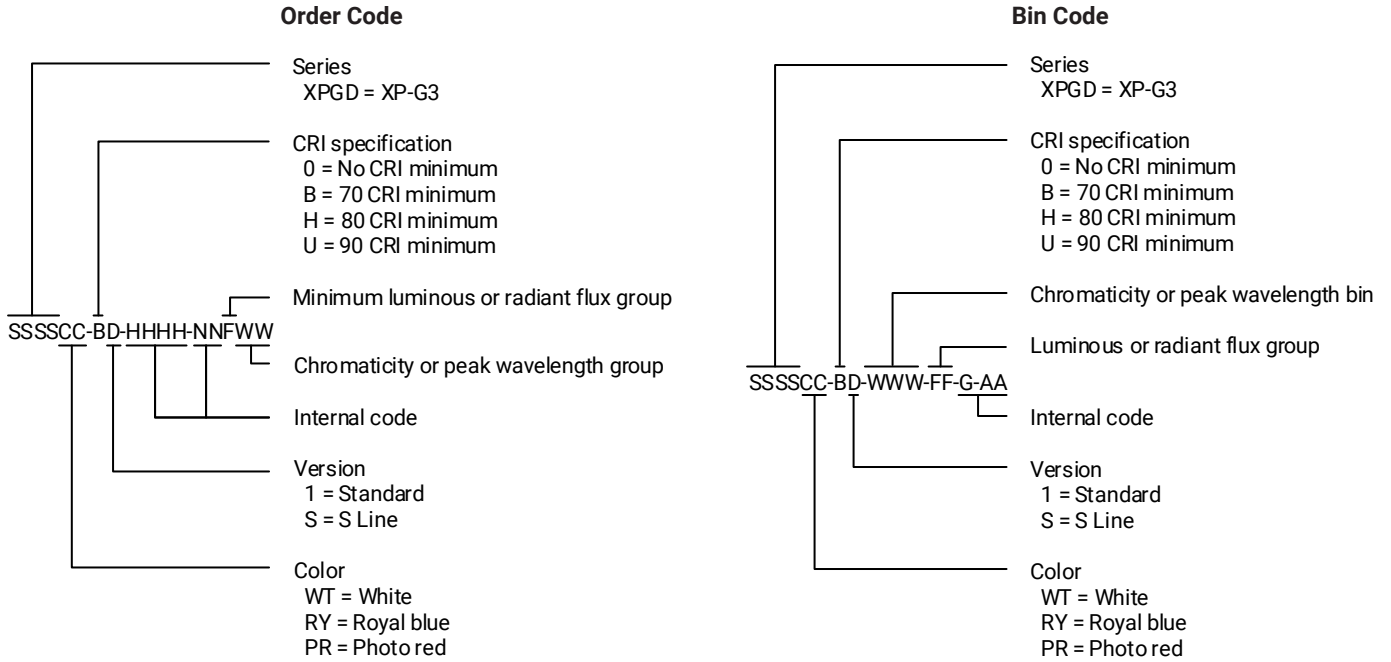

REFLOW SOLDERING CHARACTERISTICS

In testing, Cree LED has found XLamp XP-G3 LEDs to be compatible with JEDEC J-STD-020C, with the exception of the peak temperature requirements listed in the table below. As a general guideline, Cree LED recommends that users follow the recommended soldering profile provided by the manufacturer of the solder paste used, and therefore it is the lamp or luminaire manufacturer’s responsibility to determine applicable soldering requirements.

Note that this general guideline may not apply to all PCB designs and configurations of reflow soldering equipment.

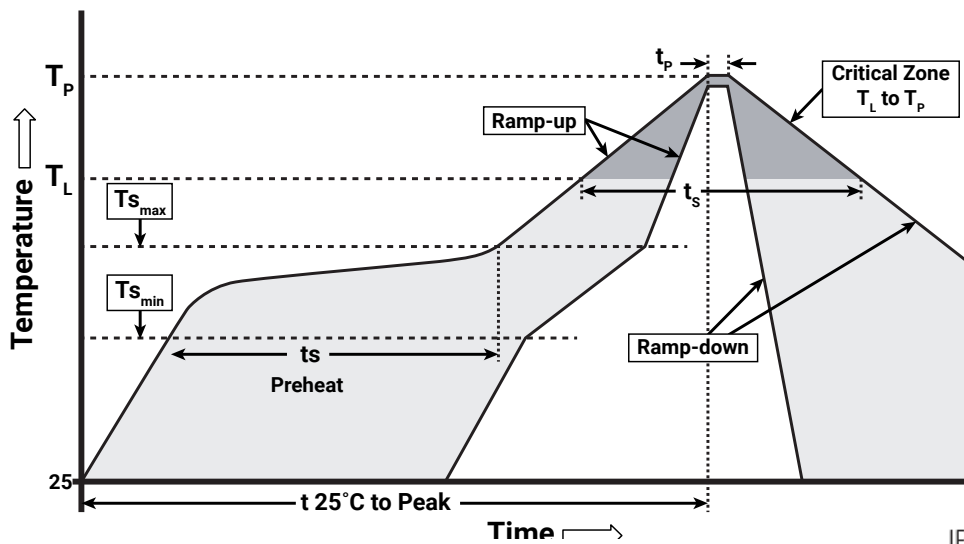

IPC/JEDEC J-STD-020C

Profile Feature	Lead-Free Solder
Average Ramp-Up Rate ($T_{s_{max}}$ to T_p)	1.2 °C/second
Preheat: Temperature Min ($T_{s_{min}}$)	120 °C
Preheat: Temperature Max ($T_{s_{max}}$)	170 °C
Preheat: Time ($t_{s_{min}}$ to $t_{s_{max}}$)	65-150 seconds
Time Maintained Above: Temperature (T_L)	217 °C
Time Maintained Above: Time (t_L)	45-90 seconds
Peak/Classification Temperature (T_p)	235 - 245 °C
Time Within 5 °C of Actual Peak Temperature (t_p)	20-40 seconds
Ramp-Down Rate	1 - 6 °C/second
Time 25 °C to Peak Temperature	4 minutes max.

Note: All temperatures refer to topside of the package, measured on the package body surface.

NOTES

Measurements

The luminous flux, radiant power, chromaticity, forward voltage and CRI measurements in this document are binning specifications only and solely represent product measurements as of the date of shipment. These measurements will change over time based on a number of factors that are not within Cree LED's control and are not intended or provided as operational specifications for the products. Calculated values are provided for informational purposes only and are not intended or provided as specifications.

Pre-Release Qualification Testing

Please read the [LED Reliability Overview](#) for details of the qualification process Cree LED applies to ensure long-term reliability for XLamp LEDs and details of Cree LED's pre-release qualification testing for XLamp LEDs. Cree LED did not perform Room Temperature Operating Life (RTOL) testing on the XP-G3 LED.

Lumen Maintenance

Cree LED now uses standardized IES LM-80-08 and TM-21-11 methods for collecting long-term data and extrapolating LED lumen maintenance. For information on the specific LM-80 data sets available for this LED, refer to the public [LM-80 results document](#).

Please read the [Long-Term Lumen Maintenance application note](#) for more details on Cree LED's lumen maintenance testing and forecasting. Please read the [Thermal Management application note](#) for details on how thermal design, ambient temperature, and drive current affect the LED junction temperature.

Moisture Sensitivity

Cree LED recommends keeping XLamp LEDs in the provided, resealable moisture-barrier packaging (MBP) until immediately prior to soldering. Unopened MBPs that contain XLamp LEDs do not need special storage for moisture sensitivity.

Once the MBP is opened, XLamp XP-G3 LEDs may be stored as MSL 1 per JEDEC J-STD-033, meaning they have unlimited floor life in conditions of ≤ 30 °C/85% relative humidity (RH). Regardless of the storage condition, Cree LED recommends sealing any unsoldered LEDs in the original MBP.

RoHS Compliance

The levels of RoHS restricted materials in this product are below the maximum concentration values (also referred to as the threshold limits) permitted for such substances, or are used in an exempted application, in accordance with EU Directive 2011/65/EC (RoHS2), as implemented January 2, 2013. RoHS Declarations for this product can be obtained from your Cree LED representative or from the [Product Ecology](#) section of the Cree LED website.

REACH Compliance

REACH substances of very high concern (SVHCs) information is available for this product. Since the European Chemical Agency (ECHA) has published notice of their intent to frequently revise the SVHC listing for the foreseeable future, please contact a Cree LED representative to insure you get the most up-to-date REACH Declaration. REACH banned substance information (REACH Article 67) is also available upon request.

NOTES - CONTINUED

UL® Recognized Component

This product meets the requirements to be considered a UL Recognized Component with Level 4 enclosure consideration. The LED package or a portion thereof has been investigated as a fire and electrical enclosure per ANSI/UL 8750.

Vision Advisory

WARNING: Do not look at an exposed lamp in operation. Eye injury can result. For more information about LEDs and eye safety, please refer to the [LED Eye Safety application note](#).

MECHANICAL DIMENSIONS (T_A = 25 °C)

Thermal vias, if present, are not shown on these drawings.

All measurements are ±.13 mm unless otherwise indicated.

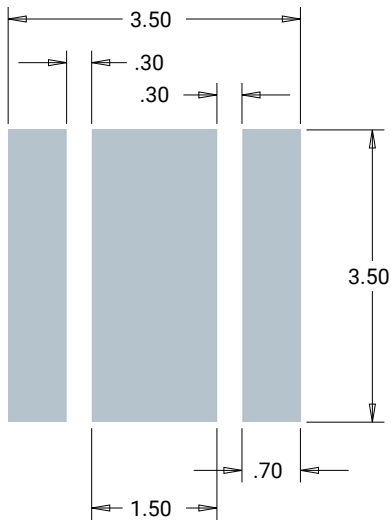
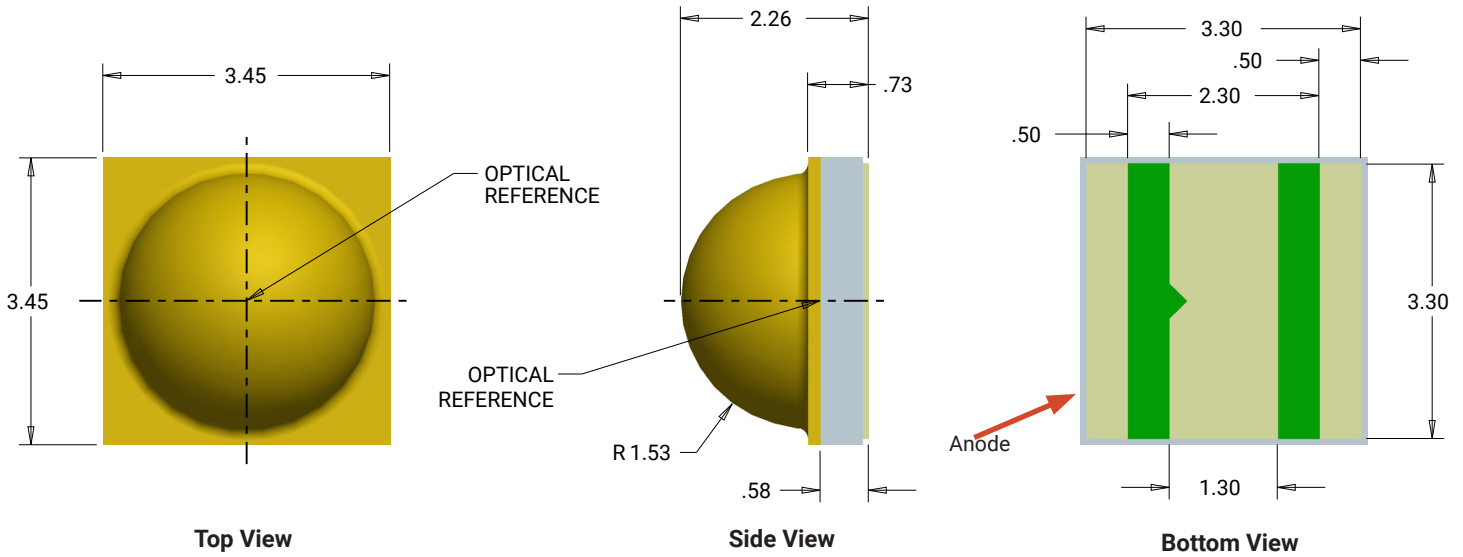

Recommended Copper Layout

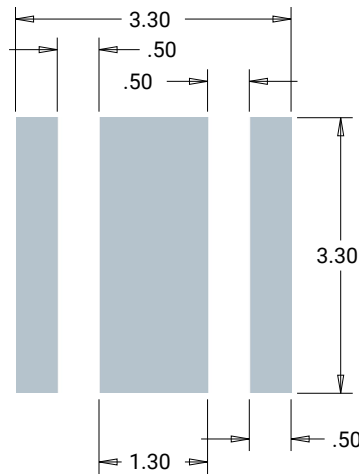

**Recommended Solder Pad
(Solder Mask Pattern)**

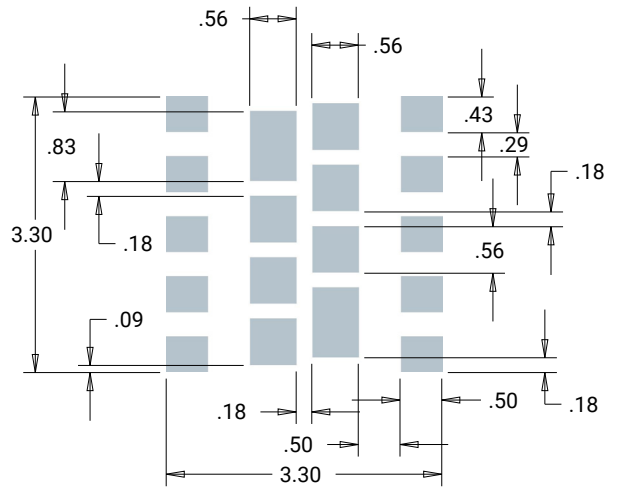

Recommended Stencil Openings*

Notes:

- Cree LED recommends using thermal pad kickouts to maximize component thermal performance.
- Cree LED recommends using white solder mask material to minimize system optical loss.
- * This stencil has been tested and optimized for the avoidance of voiding when using ALPHA® LUMET® P30 Maxrel solder paste. For other solder pastes, a "window pane" design for the thermal pad stencil may result in a lower voiding percentage. Contact your local Cree LED Field Applications Engineer for consultation regarding your specific application.

TAPE AND REEL

All Cree LED carrier tapes conform to EIA-481D, Automated Component Handling Systems Standard.

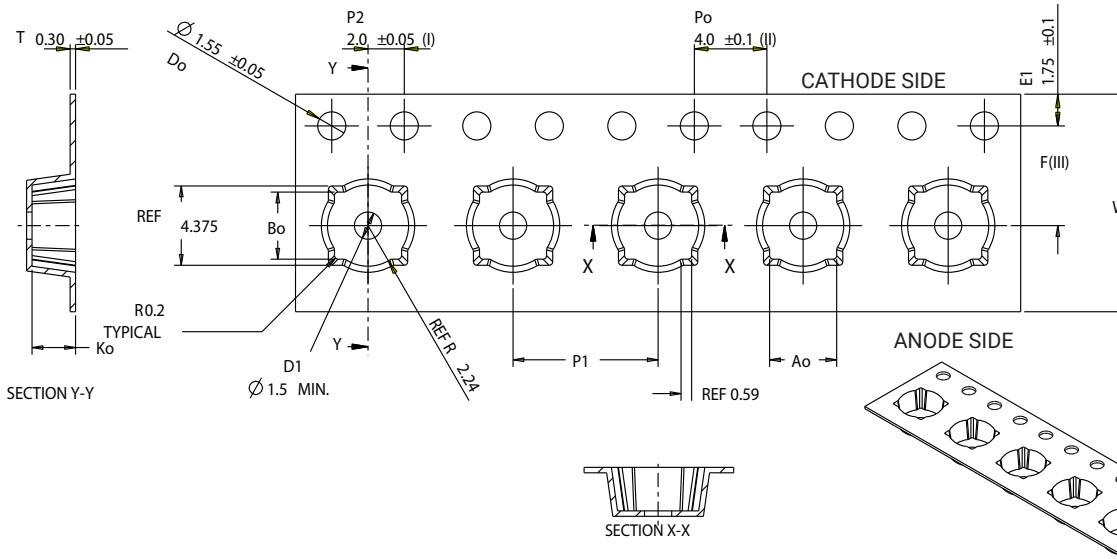

All dimensions in mm.

Ao	3.70	+/- 0.1
Bo	3.70	+/- 0.1
Ko	2.40	+0.0/-0.1
F	5.50	+/- 0.05
P 1	8.00	+/- 0.1
W	12.00	+0.3/-0.1

- (I) Measured from centerline of sprocket hole to centerline of pocket.
- (II) Cumulative tolerance of 10 sprocket holes is ± 0.20.
- (III) Measured from centerline of sprocket hole to centerline of pocket.
- (IV) Other material available.

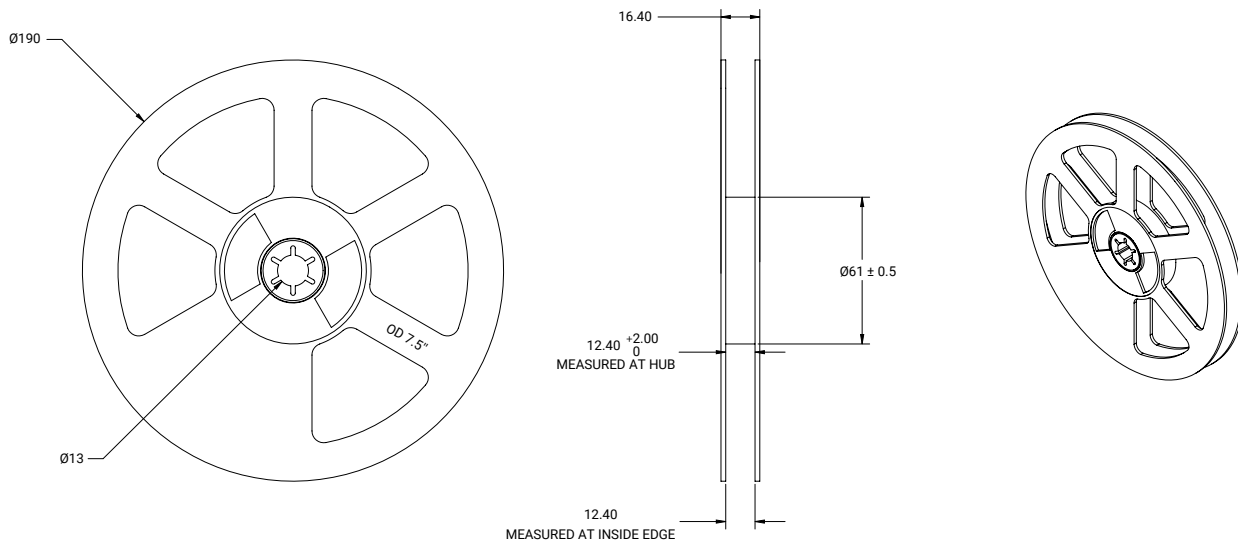
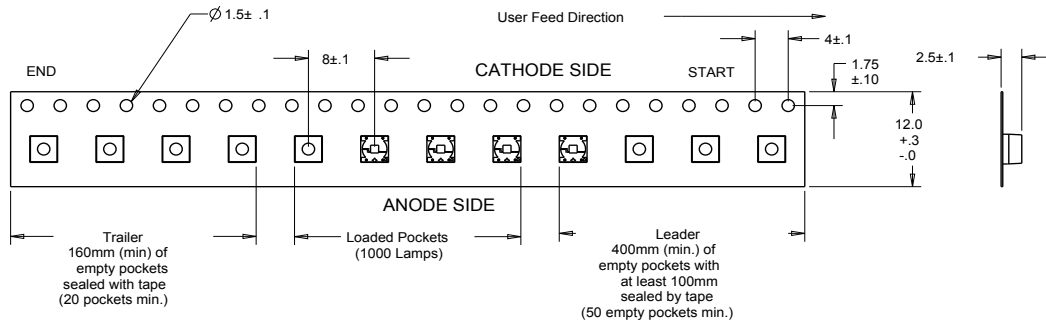

PACKAGING

Unpackaged Reel

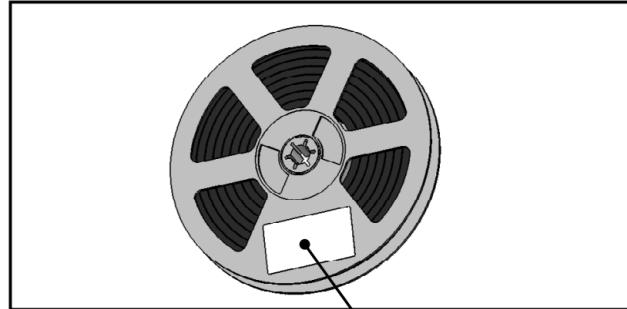

Label with Cree LED Bin Code, Quantity, Reel ID

Packaged Reel

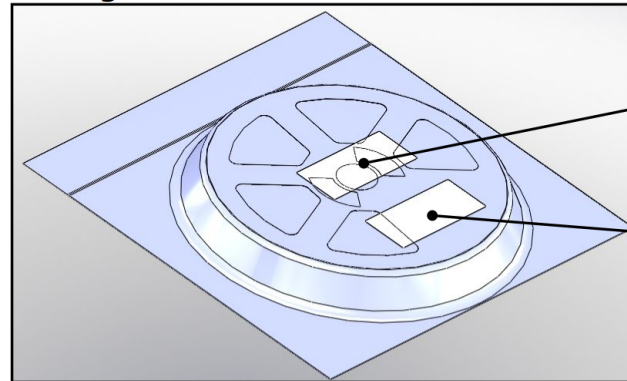

Label with Cree LED Order Code, Quantity, Reel ID, PO#

Label with Cree LED Bin Code, Quantity, Reel ID

Boxed Reel

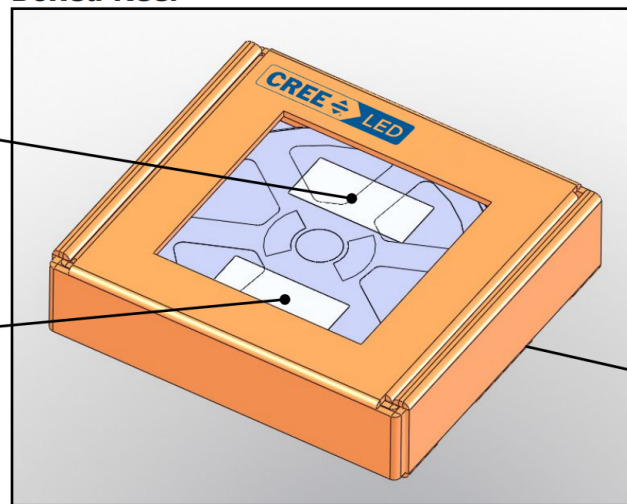

Label with Cree LED Order Code, Quantity, Reel ID, PO#

Label with Cree LED Bin Code, Quantity, Reel ID

Patent Label (on bottom of box)

APPENDIX - ORDER CODES NOT FOR NEW DESIGNS

The following order codes are active and valid order codes, but higher performance options are also available. Please see page 4 - page 9 for order codes of XLamp XP-G3 White (Standard) LEDs that could serve as alternatives for the order codes set forth below.

Chromaticity		Minimum Luminous Flux (lm) @ 350 mA			Order Codes			
Kit	CCT	Code	Flux (lm) @ 85 °C	Flux (lm) @ 25 °C*	70 CRI Typical	70 CRI Minimum	80 CRI Minimum	90 CRI Minimum
DT	7000 K	S2	148	161		XPGDWT-B1-0000-00JDT	XPGDWT-H1-0000-00JDT	
		R5	139	152			XPGDWT-H1-0000-00HDT	
CB	6500 K	S2	148	161			XPGDWT-H1-0000-00JCB	
		R5	139	152			XPGDWT-H1-0000-00HCB	
E0	>6500 K	S3	156	170	XPGDWT-01-0000-00KE0			
		S2	148	161	XPGDWT-01-0000-00JE0	XPGDWT-B1-0000-00JE0	XPGDWT-H1-0000-00JE0	
		R5	139	152			XPGDWT-H1-0000-00HE0	
E1	6500 K	S3	156	170	XPGDWT-01-0000-00KE1			
		S2	148	161	XPGDWT-01-0000-00JE1	XPGDWT-B1-0000-00JE1	XPGDWT-H1-0000-00JE1	
		R5	139	152			XPGDWT-H1-0000-00HE1	
DV	6000 K	S3	156	170	XPGDWT-01-0000-00KDV			
		S2	148	161	XPGDWT-01-0000-00JDV	XPGDWT-B1-0000-00JDV	XPGDWT-H1-0000-00JDV	
		R5	139	152			XPGDWT-H1-0000-00HDV	
		R4	130	142				
		R3	122	133				XPGDWT-U1-0000-00FDV
		R2	114	124				XPGDWT-U1-0000-00EDV
50	6000 K	S3	156	170	XPGDWT-01-0000-00K50			
		S2	148	161	XPGDWT-01-0000-00J50	XPGDWT-B1-0000-00J50	XPGDWT-H1-0000-00J50	
		R5	139	152			XPGDWT-H1-0000-00H50	
		R4	130	142				
		R3	122	133				XPGDWT-U1-0000-00F50
		R2	114	124				XPGDWT-U1-0000-00E50

Notes

- Cree LED maintains a tolerance of ±7% on flux and power measurements, ±0.005 on chromaticity (CCx, CCy) measurements and a tolerance of ±2 on CRI measurements. See the Measurements section (page 38).
- XLamp XP-G3 LED order codes specify only a minimum flux bin and not a maximum. Cree LED may ship reels in flux bins higher than the minimum specified by the order code without advance notice. Shipments will always adhere to the chromaticity bin restrictions specified by the order code.
- * Flux values @ 25 °C are calculated and for reference only.

APPENDIX - ORDER CODES NOT FOR NEW DESIGNS - CONTINUED

Chromaticity		Minimum Luminous Flux (lm) @ 350 mA			Order Codes			
Kit	CCT	Code	Flux (lm) @ 85 °C	Flux (lm) @ 25 °C*	70 CRI Typical	70 CRI Minimum	80 CRI Minimum	90 CRI Minimum
E2	5700 K	S3	156	170	XPGDWT-01-0000-00KE2			
		S2	148	161	XPGDWT-01-0000-00JE2	XPGDWT-B1-0000-00JE2	XPGDWT-H1-0000-00JE2	
		R5	139	152			XPGDWT-H1-0000-00HE2	
		R4	130	142				
		R3	122	133				XPGDWT-U1-0000-00FE2
		R2	114	124				XPGDWT-U1-0000-00EE2
2E	5700 K	S2	148	161		XPGDWT-B1-0000-00JE2	XPGDWT-H1-0000-00JE2	
		R5	139	152			XPGDWT-H1-0000-00HE2	
		R4	130	142				
		R3	122	133				XPGDWT-U1-0000-00FE2
		R2	114	124				XPGDWT-U1-0000-00EE2
3E	5000 K	S2	148	161		XPGDWT-B1-0000-00JE3	XPGDWT-H1-0000-00JE3	
		R5	139	152			XPGDWT-H1-0000-00HE3	
		R4	130	142				
		R3	122	133				XPGDWT-U1-0000-00FE3
		R2	114	124				XPGDWT-U1-0000-00EE3
E3	5000 K	S3	156	170	XPGDWT-01-0000-00KE3	XPGDWT-B1-0000-00KE3		
		S2	148	161	XPGDWT-01-0000-00JE3	XPGDWT-B1-0000-00JE3	XPGDWT-H1-0000-00JE3	
		R5	139	152			XPGDWT-H1-0000-00HE3	
		R4	130	142				
		R3	122	133				XPGDWT-U1-0000-00FE3
		R2	114	124				XPGDWT-U1-0000-00EE3
F4	4750K	S3	156	170	XPGDWT-01-0000-00KF4	XPGDWT-B1-0000-00KF4		
		S2	148	161	XPGDWT-01-0000-00JF4	XPGDWT-B1-0000-00JF4		
		R5	139	152		XPGDWT-B1-0000-00HF4	XPGDWT-H1-0000-00HF4	
		R4	130	142			XPGDWT-H1-0000-00GF4	
		R3	122	133				XPGDWT-U1-0000-00FF4
		R2	114	124				XPGDWT-U1-0000-00EF4

Notes

- Cree LED maintains a tolerance of ±7% on flux and power measurements, ±0.005 on chromaticity (CCx, CCy) measurements and a tolerance of ±2 on CRI measurements. See the Measurements section (page 38).
- XLamp XP-G3 LED order codes specify only a minimum flux bin and not a maximum. Cree LED may ship reels in flux bins higher than the minimum specified by the order code without advance notice. Shipments will always adhere to the chromaticity bin restrictions specified by the order code.
- * Flux values @ 25 °C are calculated and for reference only.

APPENDIX - ORDER CODES NOT FOR NEW DESIGNS - CONTINUED

Chromaticity		Minimum Luminous Flux (lm) @ 350 mA			Order Codes			
Kit	CCT	Code	Flux (lm) @ 85 °C	Flux (lm) @ 25 °C*	70 CRI Typical	70 CRI Minimum	80 CRI Minimum	90 CRI Minimum
4E	4500 K	S3	156	170		XPGDWT-B1-0000-00K4E		
		S2	148	161		XPGDWT-B1-0000-00J4E		
		R5	139	152			XPGDWT-H1-0000-00H4E	
		R4	130	142			XPGDWT-H1-0000-00G4E	
		R3	122	133				XPGDWT-U1-0000-00F4E
		R2	114	124				XPGDWT-U1-0000-00E4E
		Q5	107	117				XPGDWT-U1-0000-00D4E
E4	4500 K	S3	156	170	XPGDWT-01-0000-00KE4	XPGDWT-B1-0000-00KE4		
		S2	148	161	XPGDWT-01-0000-00JE4	XPGDWT-B1-0000-00JE4		
		R5	139	152		XPGDWT-B1-0000-00HE4	XPGDWT-H1-0000-00HE4	
		R4	130	142			XPGDWT-H1-0000-00GE4	
		R3	122	133				XPGDWT-U1-0000-00FE4
		R2	114	124				XPGDWT-U1-0000-00EE4
		Q5	107	117				XPGDWT-U1-0000-00DE4
F5	4200 K	S3	156	170	XPGDWT-01-0000-00KF5			
		S2	148	161	XPGDWT-01-0000-00JF5	XPGDWT-B1-0000-00JF5		
		R5	139	152		XPGDWT-B1-0000-00HF5	XPGDWT-H1-0000-00HF5	
		R4	130	142			XPGDWT-H1-0000-00GF5	
		R3	122	133				XPGDWT-U1-0000-00FF5
		R2	114	124				XPGDWT-U1-0000-00EF5
		Q5	107	117				XPGDWT-U1-0000-00DF5
5E	4000 K	S2	148	161		XPGDWT-B1-0000-00J5E		
		R5	139	152			XPGDWT-H1-0000-00H5E	
		R4	130	142			XPGDWT-H1-0000-00G5E	
		R3	122	133				XPGDWT-U1-0000-00F5E
		R2	114	124				XPGDWT-U1-0000-00E5E
		Q5	107	117				XPGDWT-U1-0000-00D5E

Notes

- Cree LED maintains a tolerance of ±7% on flux and power measurements, ±0.005 on chromaticity (CCx, CCy) measurements and a tolerance of ±2 on CRI measurements. See the Measurements section (page 38).
- XLamp XP-G3 LED order codes specify only a minimum flux bin and not a maximum. Cree LED may ship reels in flux bins higher than the minimum specified by the order code without advance notice. Shipments will always adhere to the chromaticity bin restrictions specified by the order code.
- * Flux values @ 25 °C are calculated and for reference only.

APPENDIX - ORDER CODES NOT FOR NEW DESIGNS - CONTINUED

Chromaticity		Minimum Luminous Flux (lm) @ 350 mA			Order Codes			
Kit	CCT	Code	Flux (lm) @ 85 °C	Flux (lm) @ 25 °C*	70 CRI Typical	70 CRI Minimum	80 CRI Minimum	90 CRI Minimum
E5	4000 K	S3	156	170	XPGDWT-01-0000-00KE5			
		S2	148	161	XPGDWT-01-0000-00JE5	XPGDWT-B1-0000-00JE5		
		R5	139	152		XPGDWT-B1-0000-00HE5	XPGDWT-H1-0000-00HE5	
		R4	130	142			XPGDWT-H1-0000-00GE5	
		R3	122	133				XPGDWT-U1-0000-00FE5
		R2	114	124				XPGDWT-U1-0000-00EE5
		Q5	107	117				XPGDWT-U1-0000-00DE5
F6	3700 K	S2	148	161	XPGDWT-01-0000-00JF6	XPGDWT-B1-0000-00JF6		
		R5	139	152	XPGDWT-01-0000-00HF6	XPGDWT-B1-0000-00HF6		
		R4	130	142			XPGDWT-H1-0000-00GF6	
		R3	122	133				
		R2	114	124				XPGDWT-U1-0000-00EF6
		Q5	107	117				XPGDWT-U1-0000-00DF6
		Q4	100	109				XPGDWT-U1-0000-00CF6
6E	3500 K	S2	148	161		XPGDWT-B1-0000-00JE6		
		R5	139	152		XPGDWT-B1-0000-00HE6		
		R4	130	142			XPGDWT-H1-0000-00GE6	
		R3	122	133				
		R2	114	124				XPGDWT-U1-0000-00E6E
		Q5	107	117				XPGDWT-U1-0000-00D6E
		Q4	100	109				XPGDWT-U1-0000-00C6E
6G	3500 K	R2	114	124				XPGDWT-U1-0000-00E6G
		Q5	107	117				XPGDWT-U1-0000-00D6G
		Q4	100	109				XPGDWT-U1-0000-00C6G

Notes

- Cree LED maintains a tolerance of ±7% on flux and power measurements, ±0.005 on chromaticity (CCx, CCy) measurements and a tolerance of ±2 on CRI measurements. See the Measurements section (page 38).
- XLamp XP-G3 LED order codes specify only a minimum flux bin and not a maximum. Cree LED may ship reels in flux bins higher than the minimum specified by the order code without advance notice. Shipments will always adhere to the chromaticity bin restrictions specified by the order code.
- * Flux values @ 25 °C are calculated and for reference only.

APPENDIX - ORDER CODES NOT FOR NEW DESIGNS - CONTINUED

Chromaticity		Minimum Luminous Flux (lm) @ 350 mA			Order Codes			
Kit	CCT	Code	Flux (lm) @ 85 °C	Flux (lm) @ 25 °C*	70 CRI Typical	70 CRI Minimum	80 CRI Minimum	90 CRI Minimum
E6	3500 K	S2	148	161	XPGDWT-01-0000-00JE6	XPGDWT-B1-0000-00JE6		
		R5	139	152	XPGDWT-01-0000-00HE6	XPGDWT-B1-0000-00HE6		
		R4	130	142			XPGDWT-H1-0000-00GE6	
		R3	122	133				
		R2	114	124				XPGDWT-U1-0000-00EE6
		Q5	107	117				XPGDWT-U1-0000-00DE6
		Q4	100	109				XPGDWT-U1-0000-00CE6
F7	3200 K	R5	139	152	XPGDWT-01-0000-00HF7	XPGDWT-B1-0000-00HF7		
		R4	130	142			XPGDWT-H1-0000-00GF7	
		R3	122	133				
		R2	114	124				XPGDWT-U1-0000-00EF7
		Q5	107	117				XPGDWT-U1-0000-00DF7
		Q4	100	109				XPGDWT-U1-0000-00CF7
7E	3000 K	R5	139	152		XPGDWT-B1-0000-00H7E		
		R4	130	142			XPGDWT-H1-0000-00G7E	
		R3	122	133				
		R2	114	124				XPGDWT-U1-0000-00E7E
		Q5	107	117				XPGDWT-U1-0000-00D7E
		Q4	100	109				XPGDWT-U1-0000-00C7E
7G	3000 K	R2	114	124				XPGDWT-U1-0000-00E7G
		Q5	107	117				XPGDWT-U1-0000-00D7G
		Q4	100	109				XPGDWT-U1-0000-00C7G
E7	3000 K	R5	139	152	XPGDWT-01-0000-00HE7	XPGDWT-B1-0000-00HE7		
		R4	130	142			XPGDWT-H1-0000-00GE7	
		R3	122	133				
		R2	114	124				XPGDWT-U1-0000-00EE7
		Q5	107	117				XPGDWT-U1-0000-00DE7
		Q4	100	109				XPGDWT-U1-0000-00CE7

Notes

- Cree LED maintains a tolerance of ±7% on flux and power measurements, ±0.005 on chromaticity (CCx, CCy) measurements and a tolerance of ±2 on CRI measurements. See the Measurements section (page 38).
- XLamp XP-G3 LED order codes specify only a minimum flux bin and not a maximum. Cree LED may ship reels in flux bins higher than the minimum specified by the order code without advance notice. Shipments will always adhere to the chromaticity bin restrictions specified by the order code.
- * Flux values @ 25 °C are calculated and for reference only.

APPENDIX - ORDER CODES NOT FOR NEW DESIGNS - CONTINUED

Chromaticity		Minimum Luminous Flux (lm) @ 350 mA			Order Codes			
Kit	CCT	Code	Flux (lm) @ 85 °C	Flux (lm) @ 25 °C*	70 CRI Typical	70 CRI Minimum	80 CRI Minimum	90 CRI Minimum
F8	2850 K	R3	122	133			XPGDWT-H1-0000-00FF8	
		R2	114	124				
		Q5	107	117				XPGDWT-U1-0000-00DF8
		Q4	100	109				XPGDWT-U1-0000-00CF8
8E	2700 K	R3	122	133			XPGDWT-H1-0000-00F8E	
		R2	114	124				
		Q5	107	117				XPGDWT-U1-0000-00D8E
		Q4	100	109				XPGDWT-U1-0000-00C8E
8G	2700 K	Q5	107	117				XPGDWT-U1-0000-00D8G
		Q4	100	109				XPGDWT-U1-0000-00C8G
E8	2700 K	R3	122	133			XPGDWT-H1-0000-00FE8	
		R2	114	124				
		Q5	107	117				XPGDWT-U1-0000-00DE8
		Q4	100	109				XPGDWT-U1-0000-00CE8
EA	2200 K	R3	122	133		XPGDWT-B1-0000-00FEA		
		R2	114	124		XPGDWT-B1-0000-00EEA		

Notes

- Cree LED maintains a tolerance of ±7% on flux and power measurements, ±0.005 on chromaticity (CCx, CCy) measurements and a tolerance of ±2 on CRI measurements. See the Measurements section (page 38).
- XLamp XP-G3 LED order codes specify only a minimum flux bin and not a maximum. Cree LED may ship reels in flux bins higher than the minimum specified by the order code without advance notice. Shipments will always adhere to the chromaticity bin restrictions specified by the order code.
- * Flux values @ 25 °C are calculated and for reference only.

APPENDIX - ORDER CODES NOT FOR NEW DESIGNS - CONTINUED

The following order codes are active and valid order codes, but higher performance options are also available. Please see page 10 - page 11 for order codes of XLamp XP-G3 White (S Line) LEDs that could serve as alternatives for the order codes set forth below.

Chromaticity		Minimum Luminous Flux (lm) @ 350 mA			Order Codes
Kit	CCT	Code	Flux (lm) @ 85 °C	Flux (lm) @ 25 °C*	70 CRI Minimum
E1	6500 K	S3	156	170	XPGDWT-BS-0000-00KE1
DV	6000 K	S3	156	170	XPGDWT-BS-0000-00KDV
50	6000 K	S3	156	170	XPGDWT-BS-0000-00K50
E2	5700 K	S3	156	170	XPGDWT-BS-0000-00KE2
2E	5700 K	S3	156	170	XPGDWT-BS-0000-00K2E
3E	5000 K	S3	156	170	XPGDWT-BS-0000-00K3E
E3	5000 K	S3	156	170	XPGDWT-BS-0000-00KE3
4E	4500K	S3	156	170	XPGDWT-BS-0000-00K4E
E4	4500 K	S3	156	170	XPGDWT-BS-0000-00KE4
5E	4000 K	S3	156	170	XPGDWT-BS-0000-00K5E
E5	4000 K	S3	156	170	XPGDWT-BS-0000-00KE5
6E	3500 K	S3	156	170	XPGDWT-BS-0000-00K6E
		S2	148	161	XPGDWT-BS-0000-00J6E
E6	3500 K	S3	156	170	XPGDWT-BS-0000-00KE6
		S2	148	161	XPGDWT-BS-0000-00JE6
F7	3200K	S3	156	170	XPGDWT-BS-0000-00KF7
		S2	148	161	XPGDWT-BS-0000-00JF7
7E	3000 K	S3	156	170	XPGDWT-BS-0000-00K7E
		S2	148	161	XPGDWT-BS-0000-00J7E
E7	3000 K	S3	156	170	XPGDWT-BS-0000-00KE7
		S2	148	161	XPGDWT-BS-0000-00JE7

Notes

- Cree LED maintains a tolerance of ±7% on flux and power measurements, ±0.005 on chromaticity (CCx, CCy) measurements and a tolerance of ±2 on CRI measurements. See the Measurements section (page 38).
- XLamp XP-G3 LED order codes specify only a minimum flux bin and not a maximum. Cree LED may ship reels in flux bins higher than the minimum specified by the order code without advance notice. Shipments will always adhere to the chromaticity bin restrictions specified by the order code.
- * Flux values @ 25 °C are calculated and for reference only.