

ADS54J64 Evaluation Module

The ADS54J64EVM device is an evaluation board used to evaluate the ADS54J64 Integrated Receiver from TI. This user's guide is intended to guide users through setting up and evaluating the ADC for the best performance.

Contents

1	Overview	3
	1.1 Required Hardware	3
	1.2 Required Software	3
	1.3 Evaluation Board Feature Identification Summary	4
	1.4 References	4
2	Quick Start Guide	4
	2.1 Software Installation	4
	2.2 Hardware Setup Procedure	5
	2.3 Software Setup Procedure.....	6
	2.4 Quick Start Troubleshooting.....	9
3	Optimizing Evaluation Results	10
	3.1 ADS54J64 Operating Mode.....	10
	3.2 LMK04828 Clocking Configuration.....	11
	3.3 Using an External Clock.....	11
	3.4 Using a Coherent Input Source Frequency	12
	3.5 HSDC Pro Settings.....	13
4	Software Description	14
	4.1 ADS54J64 GUI	14
	4.2 Low Level View	15
5	EVM Hardware Modifications from Default	16
Appendix A		17

List of Figures

1	EVM Feature Locations	4
2	Quick Start Test Setup.....	5
3	HSDC Pro GUI Main Panel.....	7
4	HSDC Pro Sampling Rate and Additional Device Parameters	7
5	Data Capture Results From Quick Start Procedure.....	8
6	Test Setup Using an External Device Clock Source	12
7	ADS54J64 GUI	14
8	Low Level View Tab	15

List of Tables

1	Quick Start Performance Measurements	8
2	Troubleshooting Tips	9
3	HSDC Pro ADC Output Data Rate	10
4	LK04828 Macro States Provided in Configuration GUI	11
5	HSDC Pro Options for Optimal Analysis Results	13
6	ADS54J64 GUI Tab Descriptions	14

7	Low Level View Controls	15
8	Jumper and Button Descriptions and Default Settings	17
9	Connector Descriptions.....	18
10	LED Descriptions	19

Trademarks

HP is a registered trademark of Hewlett Packard.

Microsoft, Windows are registered trademarks of Microsoft Corporation.

Rohde & Schwarz is a registered trademark of Rohde & Schwarz.

All other trademarks are the property of their respective owners.

1 Overview

This evaluation board includes the following important features:

- Transformer-coupled signal input network, allows a single-ended signal source to the EVM
- LMK04828, a system clock generator, generates the FPGA reference clock for the high-speed serial interface
- Default transformer-coupled clock input network, tests the receiver performance with a very low-noise clock
- High-speed serial data output over a standard FMC connector
- Device registers programming through a USB connector and FTDI USB-to-SPI bus translator

The ADS54J64EVM device is designed to work seamlessly with the TSW14J56EVM device, the JESD204B data-capture card from TI, and the *High-Speed Data Converter Pro* (HSDCPro) software tool. The ADS54J64EVM device is also compatible with many of the development kits from leading FPGA vendors that contain an FMC connector.

1.1 Required Hardware

The EVM evaluation kit includes the following equipment:

- ADS54J64EVM evaluation board (EVM)
- Mini-USB cable

The EVM evaluation kit *does not* include the following list of equipment, but these items are required for evaluation of this product, to achieve the best performance.

- 5-V DC power supply
- TSW14J56EVM data capture board, 5-V power supply, and mini-USB cable
- Computer running Microsoft® Windows® 8, Windows 7, or Windows XP operating system
- Two low-noise signal generators
 - Recommendations: RF generator, > 17 dBm, < –40 dBc harmonics, < 500 fs jitter 20 kHz – 20 MHz, and 10 MHz to 2 GHz frequency range
 - Examples: TSW2170EVM, HP® HP8644B, and Rohde & Schwarz® SMA100A
- Bandpass filter for analog input (between 50 MHz to 500 MHz).
 - Recommendations: bandpass filter, ≥ 60 dB harmonic attenuation, ≤ 5% bandwidth, > 18-dBm power, and < 5-dB insertion loss
 - Examples: Trilithic 5VH-series Tunable BPF, K&L BT-series Tunable BPF, TTE KC6, or KC7-series Fixed BPF
- Bandpass filter for clock input (various frequencies)
 - Recommendations: bandpass filter, ≥ 60 dB harmonic attenuation, ≤ 5% bandwidth, > 18-dBm power, < 5-dB insertion loss
 - Examples: Trilithic 5VH-series Tunable BPF, K&L BT-series Tunable BPF, TTE KC6 or KC7-series Fixed BPF
- Signal path cables, SMA or BNC with BNC-to-SMA adapters
- 6-dB, 50-Ω attenuator

1.2 Required Software

The following software is required and available online.

- To operate the ADS54J64EVM device: ADS58J64EVM GUI Installer ([sbac161.zip](#))
 - To operate the TSW14J56EVM device: [High Speed Data Converter Pro](#) software
- See [Section 1.4](#) for the software links.

1.3 Evaluation Board Feature Identification Summary

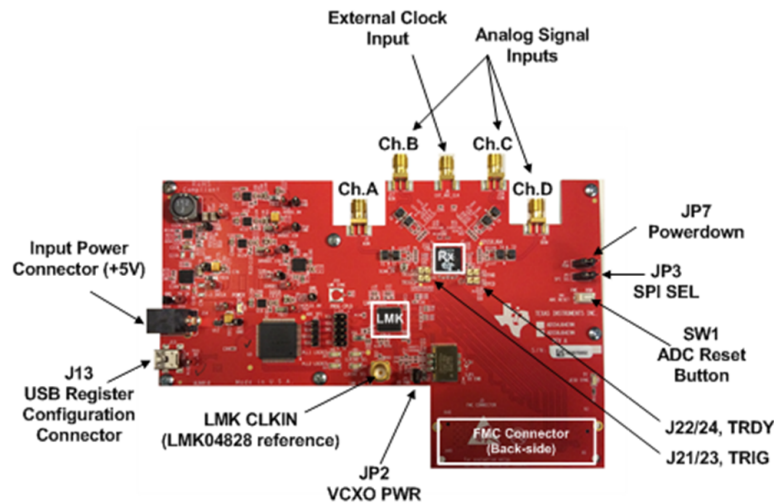

Figure 1. EVM Feature Locations

1.4 References

- [ADS58J64EVM GUI software, schematics, layout, BOM](#)
- ADS54J64 data sheet ([SBAS841](#))
- LMK04828 data sheet ([SNAS703](#))
- TSW14J56EVM user's guide ([SLWU086](#))
- High-Speed Data Converter Pro user's guide ([SLWU087](#))
- [High Speed Data Converter Pro](#) software
- ADS58J64EVM GUI Installer ([sbac161.zip](#))

2 Quick Start Guide

This section guides users through the EVM test procedure for obtaining a valid data capture from the ADS54J64EVM device, using the TSW14J56EVM capture card. This step is the starting point for all evaluations.

2.1 Software Installation

The proper software must be installed before beginning the evaluation. See [Section 1.2](#) for a list of the required software. [Section 1.4](#) of this document contains links to the required software on the TI website.

NOTE: The software must be installed before connecting the ADS54J64EVM and TSW14J56EVM devices to the computer for the first time.

2.1.1 ADS58J64 GUI Installation

The ADS54J64 GUI is used to control the devices on both the ADS58J64EVM and ADS54J64EVM. The GUI must be used to properly configure the devices on the EVM.

1. Download the GUI from [ti.com](#)
2. Extract the files from the zip file
3. Run `setup_ADS58J64EVM.exe` and follow the installation prompts

2.1.2 High-Speed Data Converter Pro GUI Installation

High-Speed Data Converter Pro (HSDC Pro) is used to control the TSW14J56EVM and analyze the captured data. Please see the HSDC Pro user's guide for more information.

1. Download HSDC Pro from the TI website. [Section 1.2](#) contains the link to find the software on the TI website.
2. Extract the files from the zip file.
3. Run setup.exe and follow the installation prompts.

2.2 Hardware Setup Procedure

Figure 2 shows a typical test setup using the ADS54J64EVM and TSW14J56EVM REV D devices. This test setup is used for the quick start procedure. The rest of this section describes the hardware setup steps.

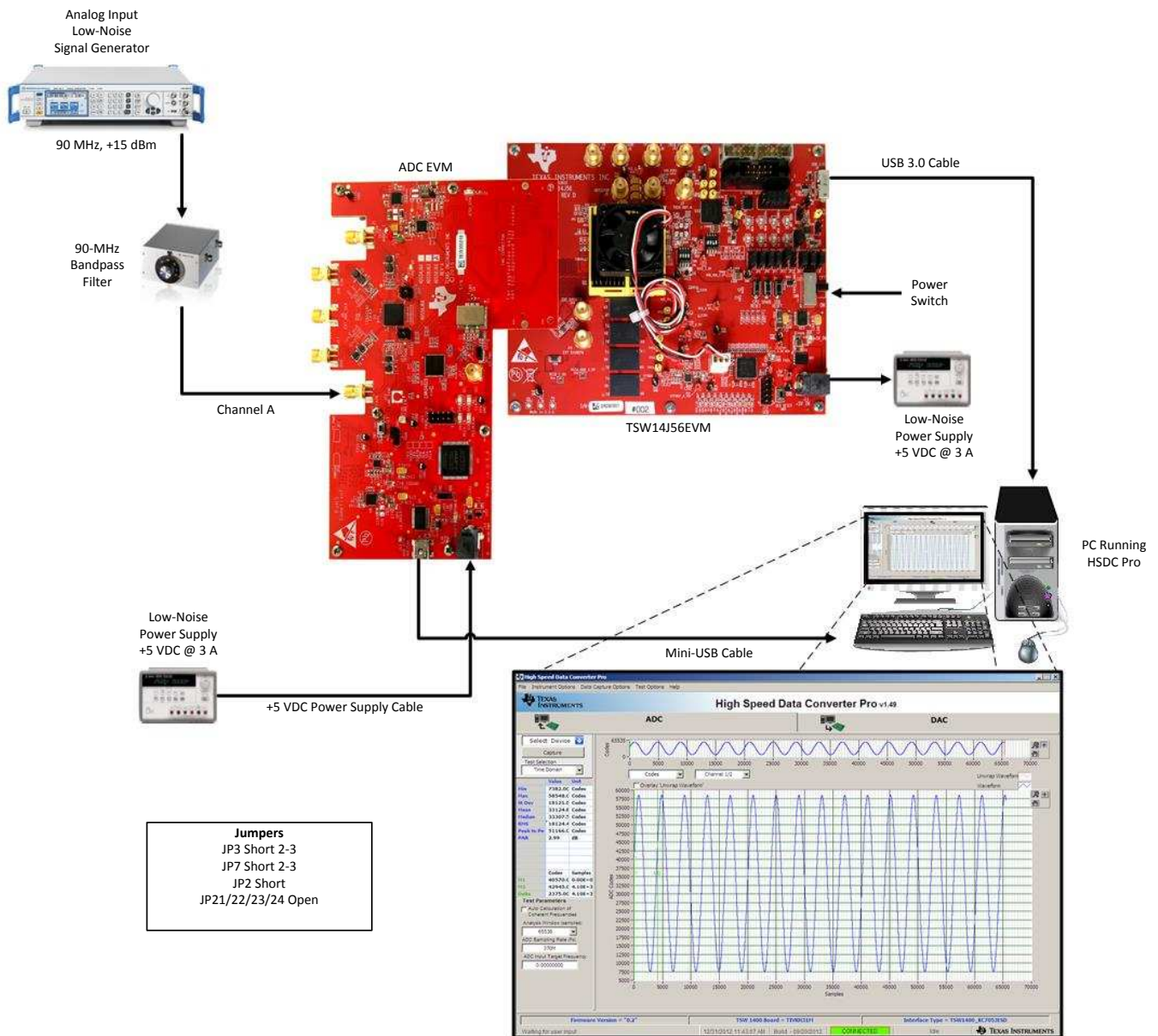

Figure 2. Quick Start Test Setup

2.2.1 TSW14J56EVM Setup

Set up the TSW14J56EVM device by following these instructions:

1. Connect the ADS54J64EVM device to the TSW14J56EVM device using the FMC connectors.
2. Connect the included 5-V power supply to connector J11 (5-V IN) of the TSW14J56EVM device.
3. Connect the included mini-USB cable to the USB connector (J9) of the TSW14J56EVM device.
4. Move the power switch (SW6) of the TSW14J56EVM device to the *on* position.

2.2.2 ADS54J64EVM Setup

Set up the ADS54J64EVM device by following these instructions:

1. Connect the included 5-V power supply to the PWR IN (J14) connector.
2. Verify that JP7 and JP3 are shorted at positions 2 – 3.
3. Verify that JP2 is shorted.
4. Connect the included mini-USB cable to the USB connector (J13).
5. Set the clock input signal generator for 61.44 MHz and 10 dBm.
6. Connect the *Clock Signal* generator to the LMK_CLK_IN (J12) connector.
7. Place the bandpass filter between the signal generator and the connector, to remove noise from the signal.
8. Set the analog input signal generator for 90 MHz and 13 dBm.
9. Connect the 6-dB attenuator to the DIN (J1) input.
10. Connect the *Analog Input Signal* generator to the 6-dB attenuator.
11. Place the bandpass filter between the analog signal generator and the attenuator input, to remove noise and harmonics from the signal generator.
12. Turn on all signal generators.

2.3 Software Setup Procedure

The software can be opened and configured once the hardware is properly set up.

2.3.1 ADS54J64 GUI Configuration

Set up the ADS54J64EVM GUI by following these instructions:

1. Open the ADS54J64EVM GUI from the Start Menu → All Programs → Texas Instruments → ADS54J64 EVM.
2. After the GUI starts, verify that the green USB Status indicator in the top right corner of the GUI is illuminated.
3. From the INTRO tab, press the *Configure LMK04828* button labeled as "Fclk=983.04MHz". To quickly evaluate device performance and check EVM functionality, the ADS54J64 EVM GUI has two sampling rate options to choose from, 983.04 MHz and 737.28 MHz.
4. Press the *ADC_RESET (SW1)* button on the ADS54J64EVM device.
5. Press the *Configure ADS54J64* button labeled as "983.04MHz Nyquist 1".
6. Press the Disable LMK04828 SYSREF to ADC button.

2.3.2 HSDC Pro GUI Configuration

Set up the HSDC Pro GUI by following these instructions.

1. Open High Speed Data Converter Pro from the Start Menu → All Programs → Texas Instruments → High Speed Data Converter Pro. **Figure 3** shows the GUI main page.

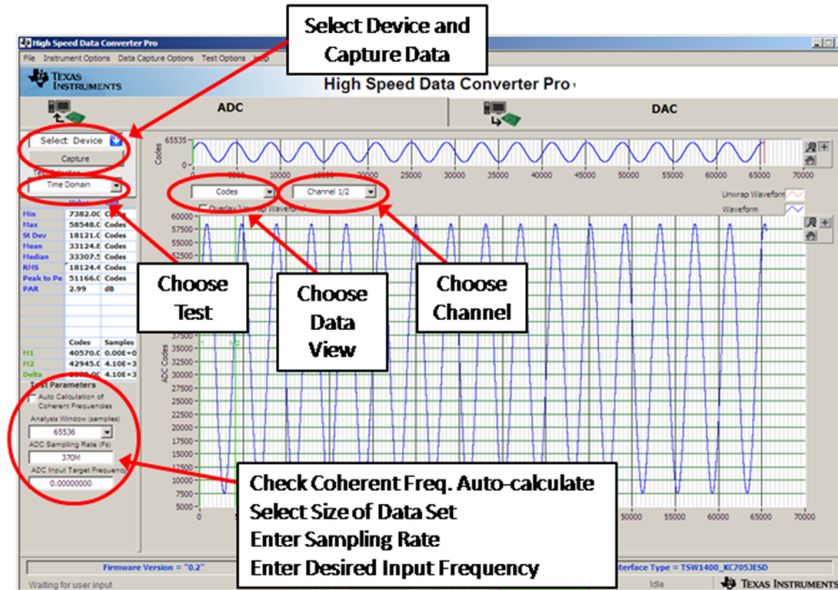

Figure 3. HSDC Pro GUI Main Panel

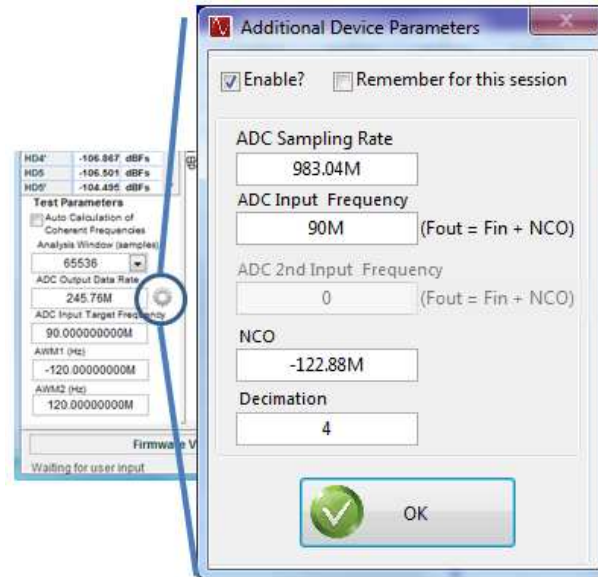

Figure 4. HSDC Pro Sampling Rate and Additional Device Parameters

2. When prompted to select the capture board, select the TSW14J56, whose serial number corresponds to the serial number on the TSW14J56EVM, and click OK.
3. Select the ADC tab at the top of the GUI.
4. Use the Select ADC drop-down menu in the top-left corner to select *ADS54J64_LMF_4841_mode01*.
5. When prompted to update the firmware for the ADC, click the Yes button, and wait for the firmware to download to the TSW14J56.

6. Press the *Additional Device Parameters* symbol next to the ADC Output Data Rate (see [Figure 4](#)), and enter the following values, then press OK:
 - Check the *Enable* box.
 - ADC Sampling Rate = 983.04M
 - ADC Input Frequency = 90M
 - NCO = -122.88M
 - Decimation = 4
7. Press the CPU_RESET button on the TSW14J56EVM device.
8. Click the *Instrument Options* menu at the top of HSDC Pro, and select *Reset Board*.
9. Click *Capture* in HSDC Pro to capture data from the ADC.
10. In HSDC Pro, change the *Test Selection* to *Single Tone*.
11. Also in HSDC Pro, change the spectrum analysis from *Real FFT* to *Complex FFT*.
12. From the *Test Options* file menu, enable the *Analysis Window Markers*.
13. Set the value of the *Analysis Window Markers* in the lower left corner of the HSDC Pro window:
 - AWM1 = -120M
 - AWM2 = 120M
14. The results from the captured data of Channel = 1 should resemble [Figure 5](#), and the performance should be similar to [Table 1](#). If this result was not achieved, then see [Section 2.4](#) of this document.

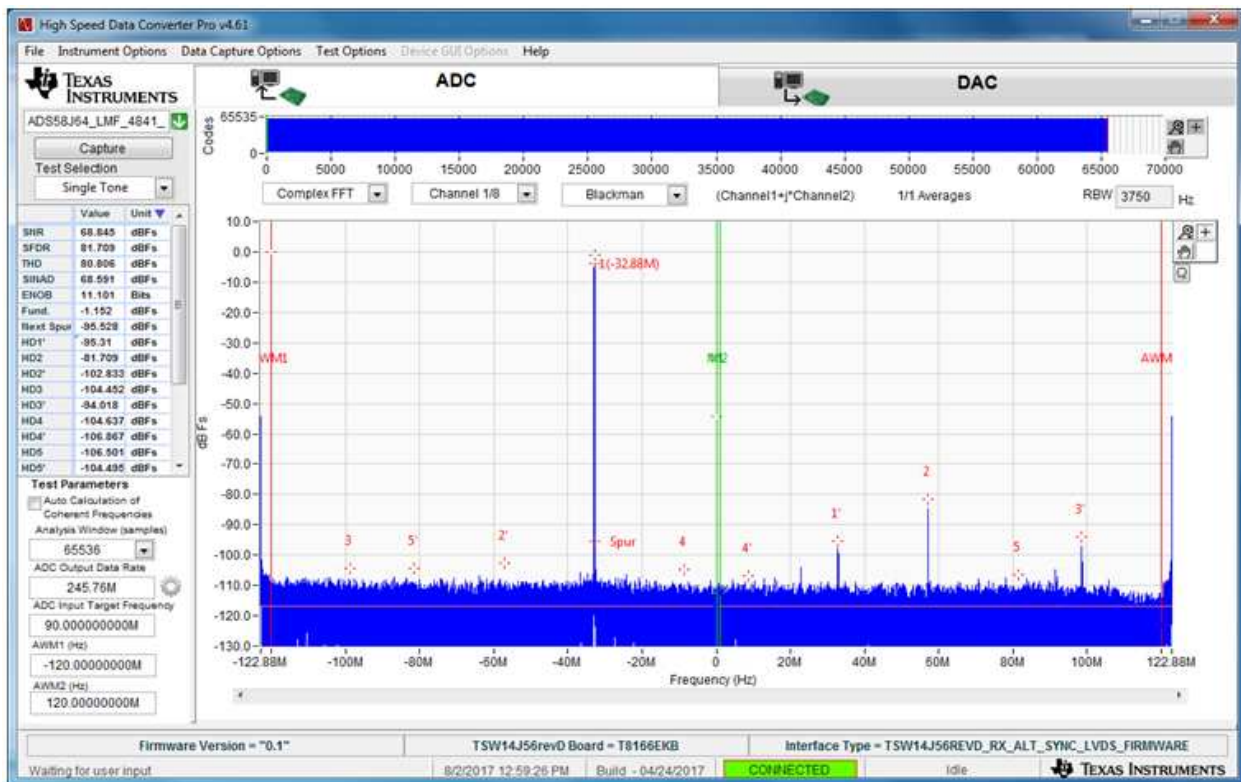

Figure 5. Data Capture Results From Quick Start Procedure

Table 1. Quick Start Performance Measurements

Result	Measured Value	Units
SNR	> 67	dBFS
SFDR	> 80	dBFS

2.4 Quick Start Troubleshooting

Table 2 lists tips which can be used to assist with problems that may have occurred during the quick start procedure.

Table 2. Troubleshooting Tips

Issue	Troubleshooting Tips
General problems	Verify the test setup shown in Figure 2 , and repeat the setup procedure as described in this document.
	Check power supplies to the EVM and TSW14J56EVM. Verify that the power switches are in the ON position.
	Check signal and clock connections to the EVM.
	Check that all boards are properly connected together.
	Try pressing the CPU_RESET button on the TSW14J56EVM.
	Try power-cycling the external power supply to the EVM and reprogram the LMK and ADC devices.
TSW14J56 LEDs are incorrect: D1, D5 – N/A D2, D4 – Flashing D3, D6, D7 – OFF D8, D28 – ON	Verify the settings of the configuration switches on the TSW14J56EVM.
	Verify that the EVM configuration GUI is communicating with the USB, and that the configuration procedure was followed.
	LEDs not flashing – reprogram the LMK device.
	Try pressing the CPU_RESET button on the TSW14J56EVM.
	Try capturing data in HSDC Pro to force an LED status update.
Device GUI is not working properly.	Verify that the USB cable is plugged into the EVM and the PC.
	Check the Device Manager of the computer, and verify that a <i>USB Serial Device</i> is recognized when the EVM is connected to the PC.
	Verify that the green <i>USB Status</i> LED light in the top-right corner of the GUI is lit. If the LED is not lit, press the Reconnect FTDI button.
	Try restarting the configuration GUI.
	Check default jumper connections as shown in Appendix A .
HSDC Pro Software is not capturing good data or analysis results are incorrect.	Verify that the TSW14J56EVM is properly connected to the PC with a mini-USB cable, and that the board serial number is properly identified by the HSDC Pro software.
	Check that the proper ADC device is selected. In default conditions, <i>ADS54J64_LMF_4841_mode01</i> must be selected.
	Check that the analysis parameters are properly configured.
HSDC Pro Software gives a time-out error when capturing data.	Try to reprogram the LMK device and reset the JESD204 Link.
	Verify that the ADC sampling rate is correct in the HSDC Pro software.
Sub-optimal measured performance	Try pressing the Calibrate ADC button on the INTRO tab, to repeat the configuration GUI procedure for programming the EVM
	Check that the spectral analysis parameters are properly configured.
	Verify that bandpass filters are used in the clock and input signal paths, and that low-noise signal sources are used.

3 Optimizing Evaluation Results

This section is meant to assist users in optimizing performance during evaluation of the product.

3.1 ADS54J64 Operating Mode

The ADS54J64 device may operate in eight different modes: Mode 0 through Mode 8 (excluding Mode 5). Each mode may require a different device selection in HSDC Pro, device configuration script in the ADS54J64 EVM GUI, and different sampling rate setup in HSDC Pro to operate correctly.

Table 3 shows the HSDC Pro sampling rate setup. The desired mode is selected from the ADS54J64EVM GUI → Mode tab in the configuration GUI.

Table 3. HSDC Pro ADC Output Data Rate

ADS54J64 Operating Mode	ADS54J64 Device Clock Frequency	HSDC Pro ADC Sampling Rate	Decimation	NCO
Mode 0	983.04 MHz	491.52M	2	-122.88M
	737.28 MHz	368.64M	2	-92.16M
Mode 1	983.04 MHz	491.52M	2	Depends on programmed NCO word
	737.28 MHz	368.64M	2	Depends on programmed NCO word
Mode 2	983.04 MHz	491.52M	2	0
	737.28 MHz	368.64M	2	0
Mode 3	983.04 MHz	491.52M	1	Depends on programmed NCO word
	737.28 MHz	368.64M	1	Depends on programmed NCO word
Mode 4	983.04 MHz	491.52M	2	Depends on programmed NCO word
	737.28 MHz	368.64M	2	Depends on programmed NCO word
Mode 6	Not yet supported.			
Mode 7 ⁽¹⁾	983.04 MHz	491.52M	2	Depends on programmed NCO word
	737.28 MHz	368.64M	2	Depends on programmed NCO word
Mode 8	983.04 MHz	491.52M	1	0
	737.28 MHz	368.64M	1	0
Mode 9	983.04 MHz	983.04M	1	0
	737.28 MHz	737.28M	1	0

⁽¹⁾ The ADC Sampling Rate used in HSDC Pro for Mode 7 depends on the .ini file used. The example shown here applies to selecting 'ADS54J64_LMF_4421_mode7' which strips the buffered 0s from the data stream.

For operating in a mode other than Mode 0, follow the default start-up procedure, and then perform the following:

1. From the ADS54J64 Mode tab in the configuration GUI, select the desired mode.
2. When selecting the device in HSDC Pro (), choose the device and enter the ADC Output Data Rate as reported by the configuration GUI on the ADS54J64 Mode tab.

Based on the sampling rate and mode of operation, adjust *ADC Output Rate Additional Device Parameters* to correctly label the harmonics. An example is shown in Figure 4 for Mode 0.

3.2 LMK04828 Clocking Configuration

The sampling clock provided to the ADS54J64 device is generated by the LMK04828 device in the default EVM hardware configuration. Configuration scripts are provided with the Configuration GUI to set up the LMK04828 device in two different states, as shown in [Table 4](#).

The states use the full PLL1 + PLL2 operation and use the onboard VCXO (Y1) for PLL1. If it is required to operate the LMK04828 device in clock distribution mode, the onboard VCXO must be disabled by removing the shorting jumper at JP2.

Table 4. LK04828 Macro States Provided in Configuration GUI

Macro State Script	LMK04828 Mode	ADS54J64 Device Clock Frequency	Clock Frequency Required at LMK_CLK_IN (J12)	Configuration GUI Shortcut	JP2
LMK04828_config2_737M.cfg	PLL1 + PLL2	737.26 MHz	61.44 MHz	Button on INTRO tab	Short
LMK04828_config2_983M.cfg	PLL1 + PLL2	983.04 MHz	61.44 MHz	Button on INTRO tab	Short
LMK04828_config1.cfg	Clock distribution	Equal to frequency at LMK_CLK_IN	Flexible	Not available	Open

3.3 Using an External Clock

The LMK04828 device provides a very low-noise device clock, but the noise performance may not be as good as a premium bench RF signal generator, so the measured noise performance of the ADS54J64 device can be optimized by using an external signal generator as a clock source.

To provide the ADS54J64 device with an external clock (through EXT_ADC_CLK, J6 on the EVM), the following hardware changes must be performed on the EVM:

- Remove C47 and C48
- Place R35 and R39 with 0.1- μ F 0402 capacitors.

The external clock is provided to the EVM through the J6 SMA connector at the full device clock rate (983.04 or 737.26 MHz), and amplitude of 6 dBm. This signal path must be filtered to reduce the broadband noise and remove any nonharmonic spurs. Narrow-band filters are recommended to remove as much noise as possible. If a signal generator output is used directly without filtering, significant degradation in SNR results.

A signal with the same frequency must also be provided to the LMK_CLK_IN J12 SMA connector with an amplitude of 6 dBm. If these signals are provided from different signal generators, the frequencies of the signals provided to J6 and J12 must be frequency locked together. Alternatively, a power splitter may be used to divide the signal from a single clock generator. When using an external clock, the LMK04828 device must be configured using the *LMK04828_config1.cfg* macro.

Figure 6 shows the test setup using an external device clock source.

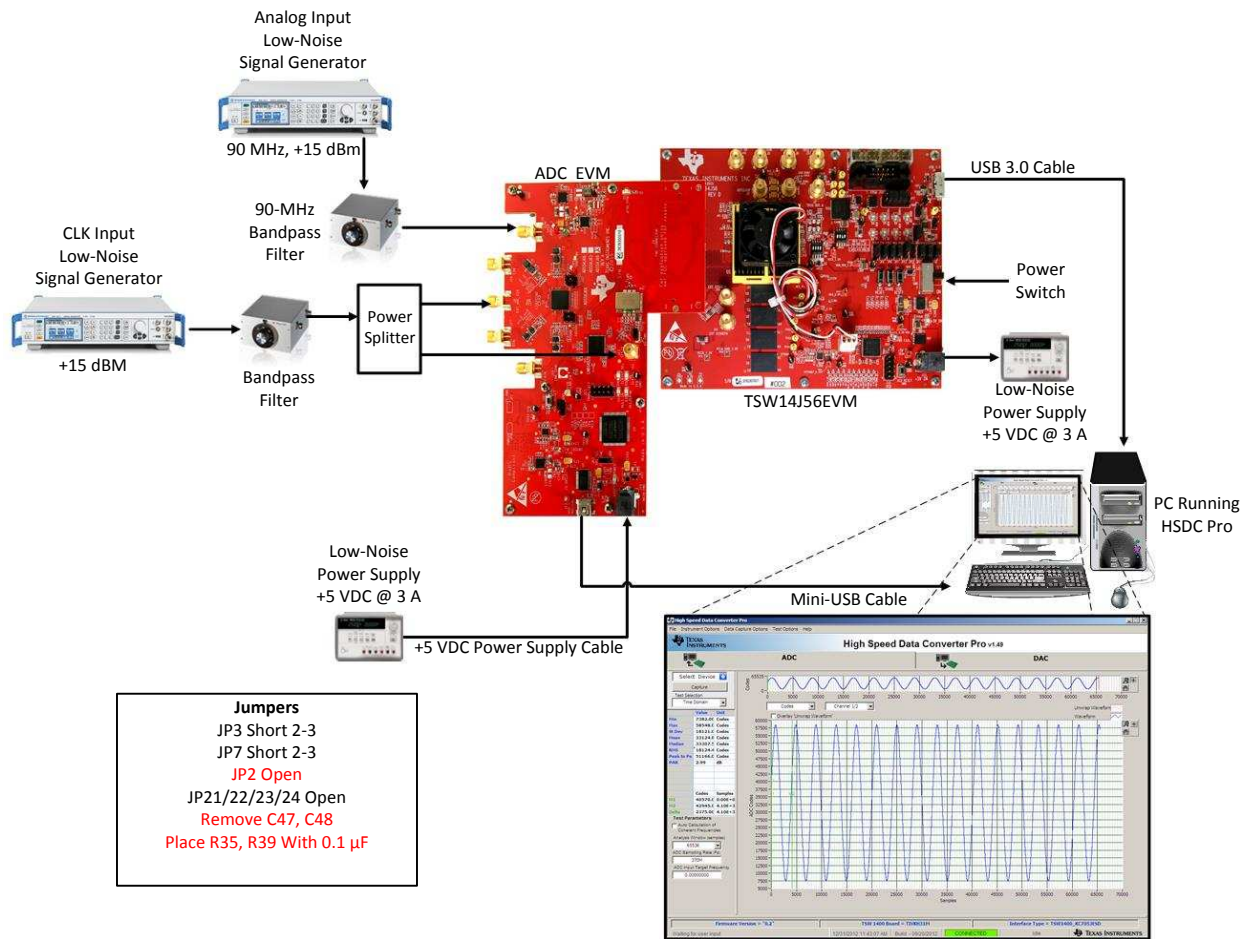

Figure 6. Test Setup Using an External Device Clock Source

3.4 Using a Coherent Input Source Frequency

A rectangular window function can be applied to the captured data when the sample rate and the input frequency are set precisely to capture an integer number of cycles of the input frequency (sometimes called coherent frequency). Coherent input and sampling frequencies may yield better SNR results. The clock and analog inputs must be frequency locked (such as through 10-MHz references) to achieve coherency.

3.5 HSDC Pro Settings

Table 5 lists the HSDC Pro options which can help improve the performance measurements.

Table 5. HSDC Pro Options for Optimal Analysis Results

HSDC Pro Feature	Description
Analysis window (samples)	Selects the number of samples to include in the selected test analysis. Collect more data to improve frequency resolution of FFT analysis.
Data windowing function	Select the desired windowing function applied to the data for FFT analysis. Select 'Blackman' when sampling a non-coherent input signal or 'Rectangle' when sampling a coherent input signal.
Test options → notch frequency bins	Select bins to be removed from the spectrum and back-filled with the average noise level. May also customize which Harmonics/Spurs are considered in SNR and THD calculations and select the method for calculating spur power.
Test options → analysis window markers	Enable markers to narrow the Single-Tone FFT test analysis to a specific bandwidth.
Data capture options → capture options	Configure the number of contiguous samples per capture (capture depth). May also enable Continuous Capture and FFT Averaging.

4 Software Description

4.1 ADS54J64 GUI

Figure 7 shows the front page of the ADS54J64 GUI as it appears upon opening the GUI.

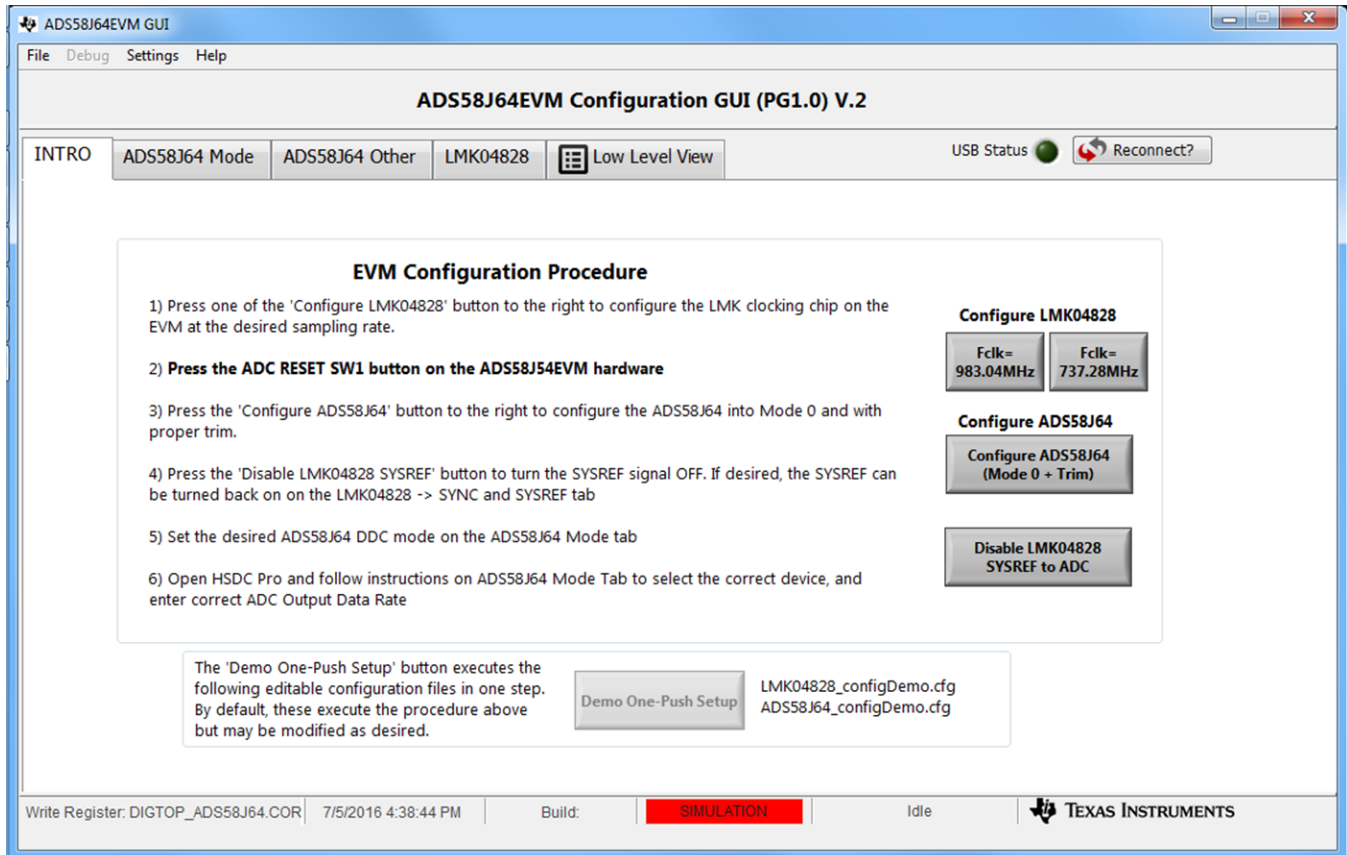

Figure 7. ADS54J64 GUI

Table 6 lists descriptions for each of the tabs of the GUI.

Table 6. ADS54J64 GUI Tab Descriptions

Tab	Description
INTRO	Quick configuration of the devices on the EVM for evaluation
ADS54J64 Mode	Provides DDC Mode control for the ADS54J64
ADS54J64 Other	Provides additional functionality controls for the ADS54J64
LMK04828	Provides controls for the LMK04828 features that can be used to customize evaluation or set up more advanced clocking schemes.
Low Level View	Allows write and read access to all device registers and bits. Also allows loading and saving of configuration files. The device configurations can be saved from this tab for use in the user's system.

4.2 Low Level View

Figure 8 shows the Low Level View tab, which allows users to configure the ADS54J64 ADC at the register bit and field levels.

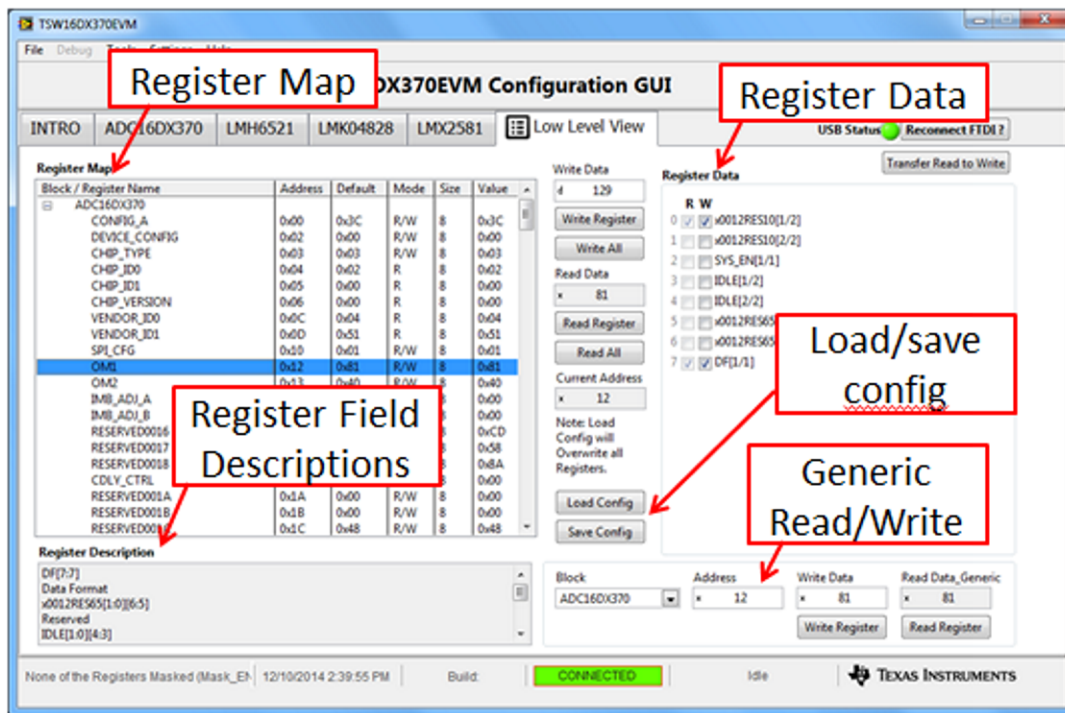

Figure 8. Low Level View Tab

At any time, the controls described in Table 7 can be used to configure or read from the device.

Table 7. Low Level View Controls

Control	Description
Register Map	Displays the devices on the EVM, registers for those devices, and the states of the registers. <ul style="list-style-type: none"> Selecting a register field allows bit manipulation in the Register Data section. The Value column shows the value of the register at the time the GUI was last updated due to a read or write event.
Write Register button	Write to the register highlighted in the Register Map with the value in the Write Data field. This button must be clicked after changing bits in the register data section.
Write All button	Update all registers shown in the Register Map with the values shown in the Register Map summary.
Read Register button	Read from the register highlighted in the Register Map and display the results in the Value column.
Read All button	Read from all registers in the Register Map and display current state of hardware. Also updates the controls in the other tabs.
Load Config button	Load a Configuration File from the disk and write the registers in the file.
Save Config button	Save a Configuration File to the disk that contains the current register configuration.
Register Data Cluster	Manipulate individual accessible bits of the register highlighted in the Register Map.
Generic Read Register and Write Register buttons	Perform a generic read or write command to the device shown in the Block drop-down box using the Address and Write Data information

5 EVM Hardware Modifications from Default

The following hardware changes are required for proper operation of the ADS54J64EVM Rev.A default PCB, built and assembled with PG1.0 ADS54J64 silicon:

1. Replace C72/73 with 75- Ω 0402 resistors
2. Place R105/106 with 150- Ω 0402 resistors

A.1 Jumper, Header, and Button Descriptions

Table 8 lists the EVM jumpers and buttons, as well as the default settings for the jumpers. If there are issues, use Table 8 to reset the EVM in the default configuration.

Table 8. Jumper and Button Descriptions and Default Settings

Jumper	Description	Default Setting
JP7	Rx Global Power-Down	Short 2 – 3
	Short 1 – 2: Force as logic HIGH (power down)	
	Short 2 – 3: Force as logic LOW (normal operation)	
	NOTE: Open is not a valid state for this jumper.	
JP3	SPI Select, CPLD	Short 2 – 3
	Short 1 – 2: Reserved. Do not use this state.	
	Short 2 – 3: Default state	
	NOTE: Open is not a valid state for this jumper.	
JP2	VCXO Power	Short
	Short: Supplies 3.3 V to Y1 VCXO	
	Open: Disconnects power from Y1 VCXO	
TRIGAB	External trigger for Burst Mode, channels A and B	Open
	Pin 1: Trigger signal, 1.8-V logic	
	Pin 2: Ground	
	Open: Trigger function not used	
TRIGCD	External trigger input for Burst Mode, channels C and D	Open
	Pin 1: Trigger signal, 1.8-V logic	
	Pin 2: Ground	
	Open: Trigger function not used	
TRDYAB	Trigger Ready output for Burst Mode, channel A and B	Open
	Pin 1: Trigger ready signal, 1.8-V logic	
	Pin 2: Ground	
TRDYCD	Trigger Ready output for Burst Mode, channel C and D	Open
	Pin 1: Trigger ready signal, 1.8-V logic	
	Pin 2: Ground	
SW1	ADC Reset	N/A
	Press to reset ADC and its registers.	
J15	ADS54J64 SPI Monitoring Header, ADC SPI	OPEN
	Pin1: SCK	
	Pin2: SEN	
	Pin3: SDIO	
	Pin4: SDO	

Table 8. Jumper and Button Descriptions and Default Settings (continued)

Jumper	Description	Default Setting
J14	JTAG Programming Header for CPLD, U3	OPEN
	Pin1: TCK	
	Pin3: TDO	
	Pin4: +1.8 V	
	Pin5: TMS	
	Pin9: TDI	
	Pin2, Pin10: GND	

A.2 Connector Descriptions

Table 9 lists the EVM connectors and their function.

Table 9. Connector Descriptions

Connector	Description
AIN (J1)	Receiver (ADS54J64) analog input, channel A
BIN (J7)	Receiver (ADS54J64) analog input, channel B
CIN (J8)	Receiver (ADS54J64) analog input, channel C
DIN (J5)	Receiver (ADS54J64) analog input, channel D
EXT_ADC_CLK (J6)	Receiver (ADS54J64) external clock input
LMK_CLK_IN (J12)	LMK04828 reference clock input
J13	USB3 mini connector for device configuration
J14	5-V power connector

A.3 LED Descriptions

Table 10 lists the EVM LEDs.

Table 10. LED Descriptions

LED	Description
PWR (D2)	Indicates status of input power
	OFF: Power is <i>not</i> provided at J14
	ON: Power <i>is</i> provided at J14
CLKIN0 SEL (D4)	Not functional
CLKIN1 SEL (D5)	Not functional
PLL1 LOCKED (D6)	LMK04828 lock detect, PLL1
	OFF: PLL is <i>not</i> locked
	ON: PLL <i>is</i> locked
PLL2 LOCKED (D3)	LMK04828 Lock Detect, PLL2
	OFF: PLL is <i>not</i> locked
	ON: PLL <i>is</i> locked
JESD_SYNC (D7)	Not functional. Always dimly lit.

STANDARD TERMS FOR EVALUATION MODULES

1. *Delivery:* TI delivers TI evaluation boards, kits, or modules, including any accompanying demonstration software, components, and/or documentation which may be provided together or separately (collectively, an "EVM" or "EVMs") to the User ("User") in accordance with the terms set forth herein. User's acceptance of the EVM is expressly subject to the following terms.
 - 1.1 EVMs are intended solely for product or software developers for use in a research and development setting to facilitate feasibility evaluation, experimentation, or scientific analysis of TI semiconductor products. EVMs have no direct function and are not finished products. EVMs shall not be directly or indirectly assembled as a part or subassembly in any finished product. For clarification, any software or software tools provided with the EVM ("Software") shall not be subject to the terms and conditions set forth herein but rather shall be subject to the applicable terms that accompany such Software
 - 1.2 EVMs are not intended for consumer or household use. EVMs may not be sold, sublicensed, leased, rented, loaned, assigned, or otherwise distributed for commercial purposes by Users, in whole or in part, or used in any finished product or production system.
2. *Limited Warranty and Related Remedies/Disclaimers:*
 - 2.1 These terms do not apply to Software. The warranty, if any, for Software is covered in the applicable Software License Agreement.
 - 2.2 TI warrants that the TI EVM will conform to TI's published specifications for ninety (90) days after the date TI delivers such EVM to User. Notwithstanding the foregoing, TI shall not be liable for a nonconforming EVM if (a) the nonconformity was caused by neglect, misuse or mistreatment by an entity other than TI, including improper installation or testing, or for any EVMs that have been altered or modified in any way by an entity other than TI, (b) the nonconformity resulted from User's design, specifications or instructions for such EVMs or improper system design, or (c) User has not paid on time. Testing and other quality control techniques are used to the extent TI deems necessary. TI does not test all parameters of each EVM. User's claims against TI under this Section 2 are void if User fails to notify TI of any apparent defects in the EVMs within ten (10) business days after delivery, or of any hidden defects with ten (10) business days after the defect has been detected.
 - 2.3 TI's sole liability shall be at its option to repair or replace EVMs that fail to conform to the warranty set forth above, or credit User's account for such EVM. TI's liability under this warranty shall be limited to EVMs that are returned during the warranty period to the address designated by TI and that are determined by TI not to conform to such warranty. If TI elects to repair or replace such EVM, TI shall have a reasonable time to repair such EVM or provide replacements. Repaired EVMs shall be warranted for the remainder of the original warranty period. Replaced EVMs shall be warranted for a new full ninety (90) day warranty period.
3. *Regulatory Notices:*
 - 3.1 *United States*
 - 3.1.1 *Notice applicable to EVMs not FCC-Approved:*

FCC NOTICE: This kit is designed to allow product developers to evaluate electronic components, circuitry, or software associated with the kit to determine whether to incorporate such items in a finished product and software developers to write software applications for use with the end product. This kit is not a finished product and when assembled may not be resold or otherwise marketed unless all required FCC equipment authorizations are first obtained. Operation is subject to the condition that this product not cause harmful interference to licensed radio stations and that this product accept harmful interference. Unless the assembled kit is designed to operate under part 15, part 18 or part 95 of this chapter, the operator of the kit must operate under the authority of an FCC license holder or must secure an experimental authorization under part 5 of this chapter.
 - 3.1.2 *For EVMs annotated as FCC – FEDERAL COMMUNICATIONS COMMISSION Part 15 Compliant:*

CAUTION

This device complies with part 15 of the FCC Rules. Operation is subject to the following two conditions: (1) This device may not cause harmful interference, and (2) this device must accept any interference received, including interference that may cause undesired operation.

Changes or modifications not expressly approved by the party responsible for compliance could void the user's authority to operate the equipment.

FCC Interference Statement for Class A EVM devices

NOTE: This equipment has been tested and found to comply with the limits for a Class A digital device, pursuant to part 15 of the FCC Rules. These limits are designed to provide reasonable protection against harmful interference when the equipment is operated in a commercial environment. This equipment generates, uses, and can radiate radio frequency energy and, if not installed and used in accordance with the instruction manual, may cause harmful interference to radio communications. Operation of this equipment in a residential area is likely to cause harmful interference in which case the user will be required to correct the interference at his own expense.

FCC Interference Statement for Class B EVM devices

NOTE: This equipment has been tested and found to comply with the limits for a Class B digital device, pursuant to part 15 of the FCC Rules. These limits are designed to provide reasonable protection against harmful interference in a residential installation. This equipment generates, uses and can radiate radio frequency energy and, if not installed and used in accordance with the instructions, may cause harmful interference to radio communications. However, there is no guarantee that interference will not occur in a particular installation. If this equipment does cause harmful interference to radio or television reception, which can be determined by turning the equipment off and on, the user is encouraged to try to correct the interference by one or more of the following measures:

- Reorient or relocate the receiving antenna.
- Increase the separation between the equipment and receiver.
- Connect the equipment into an outlet on a circuit different from that to which the receiver is connected.
- Consult the dealer or an experienced radio/TV technician for help.

3.2 Canada

3.2.1 For EVMs issued with an Industry Canada Certificate of Conformance to RSS-210 or RSS-247

Concerning EVMs Including Radio Transmitters:

This device complies with Industry Canada license-exempt RSSs. Operation is subject to the following two conditions:

(1) this device may not cause interference, and (2) this device must accept any interference, including interference that may cause undesired operation of the device.

Concernant les EVMs avec appareils radio:

Le présent appareil est conforme aux CNR d'Industrie Canada applicables aux appareils radio exempts de licence. L'exploitation est autorisée aux deux conditions suivantes: (1) l'appareil ne doit pas produire de brouillage, et (2) l'utilisateur de l'appareil doit accepter tout brouillage radioélectrique subi, même si le brouillage est susceptible d'en compromettre le fonctionnement.

Concerning EVMs Including Detachable Antennas:

Under Industry Canada regulations, this radio transmitter may only operate using an antenna of a type and maximum (or lesser) gain approved for the transmitter by Industry Canada. To reduce potential radio interference to other users, the antenna type and its gain should be so chosen that the equivalent isotropically radiated power (e.i.r.p.) is not more than that necessary for successful communication. This radio transmitter has been approved by Industry Canada to operate with the antenna types listed in the user guide with the maximum permissible gain and required antenna impedance for each antenna type indicated. Antenna types not included in this list, having a gain greater than the maximum gain indicated for that type, are strictly prohibited for use with this device.

Concernant les EVMs avec antennes détachables

Conformément à la réglementation d'Industrie Canada, le présent émetteur radio peut fonctionner avec une antenne d'un type et d'un gain maximal (ou inférieur) approuvé pour l'émetteur par Industrie Canada. Dans le but de réduire les risques de brouillage radioélectrique à l'intention des autres utilisateurs, il faut choisir le type d'antenne et son gain de sorte que la puissance isotrope rayonnée équivalente (p.i.r.e.) ne dépasse pas l'intensité nécessaire à l'établissement d'une communication satisfaisante. Le présent émetteur radio a été approuvé par Industrie Canada pour fonctionner avec les types d'antenne énumérés dans le manuel d'usage et ayant un gain admissible maximal et l'impédance requise pour chaque type d'antenne. Les types d'antenne non inclus dans cette liste, ou dont le gain est supérieur au gain maximal indiqué, sont strictement interdits pour l'exploitation de l'émetteur.

3.3 Japan

3.3.1 *Notice for EVMs delivered in Japan:* Please see http://www.tij.co.jp/lstds/ti_ja/general/eStore/notice_01.page 日本国内に輸入される評価用キット、ボードについては、次のところをご覧ください。
http://www.tij.co.jp/lstds/ti_ja/general/eStore/notice_01.page

3.3.2 *Notice for Users of EVMs Considered "Radio Frequency Products" in Japan:* EVMs entering Japan may not be certified by TI as conforming to Technical Regulations of Radio Law of Japan.

If User uses EVMs in Japan, not certified to Technical Regulations of Radio Law of Japan, User is required to follow the instructions set forth by Radio Law of Japan, which includes, but is not limited to, the instructions below with respect to EVMs (which for the avoidance of doubt are stated strictly for convenience and should be verified by User):

1. Use EVMs in a shielded room or any other test facility as defined in the notification #173 issued by Ministry of Internal Affairs and Communications on March 28, 2006, based on Sub-section 1.1 of Article 6 of the Ministry's Rule for Enforcement of Radio Law of Japan,
2. Use EVMs only after User obtains the license of Test Radio Station as provided in Radio Law of Japan with respect to EVMs, or
3. Use of EVMs only after User obtains the Technical Regulations Conformity Certification as provided in Radio Law of Japan with respect to EVMs. Also, do not transfer EVMs, unless User gives the same notice above to the transferee. Please note that if User does not follow the instructions above, User will be subject to penalties of Radio Law of Japan.

【無線電波を送信する製品の開発キットをお使いになる際の注意事項】 開発キットの中には技術基準適合証明を受けていないものがあります。技術適合証明を受けていないものご使用に際しては、電波法遵守のため、以下のいずれかの措置を取っていただく必要がありますのでご注意ください。

1. 電波法施行規則第6条第1項第1号に基づく平成18年3月28日総務省告示第173号で定められた電波暗室等の試験設備でご使用いただく。
2. 実験局の免許を取得後ご使用いただく。
3. 技術基準適合証明を取得後ご使用いただく。

なお、本製品は、上記の「ご使用にあたっての注意」を譲渡先、移転先に通知しない限り、譲渡、移転できないものとします。

上記を遵守頂けない場合は、電波法の罰則が適用される可能性があることをご留意ください。日本テキサス・インスツルメンツ株式会社
東京都新宿区西新宿 6 丁目 2 4 番 1 号
西新宿三井ビル

3.3.3 *Notice for EVMs for Power Line Communication:* Please see http://www.tij.co.jp/lstds/ti_ja/general/eStore/notice_02.page
電力線搬送波通信についての開発キットをお使いになる際の注意事項については、次のところをご覧ください。 http://www.tij.co.jp/lstds/ti_ja/general/eStore/notice_02.page

3.4 *European Union*

3.4.1 *For EVMs subject to EU Directive 2014/30/EU (Electromagnetic Compatibility Directive):*

This is a class A product intended for use in environments other than domestic environments that are connected to a low-voltage power-supply network that supplies buildings used for domestic purposes. In a domestic environment this product may cause radio interference in which case the user may be required to take adequate measures.

4 *EVM Use Restrictions and Warnings:*

4.1 EVMS ARE NOT FOR USE IN FUNCTIONAL SAFETY AND/OR SAFETY CRITICAL EVALUATIONS, INCLUDING BUT NOT LIMITED TO EVALUATIONS OF LIFE SUPPORT APPLICATIONS.

4.2 User must read and apply the user guide and other available documentation provided by TI regarding the EVM prior to handling or using the EVM, including without limitation any warning or restriction notices. The notices contain important safety information related to, for example, temperatures and voltages.

4.3 *Safety-Related Warnings and Restrictions:*

4.3.1 User shall operate the EVM within TI's recommended specifications and environmental considerations stated in the user guide, other available documentation provided by TI, and any other applicable requirements and employ reasonable and customary safeguards. Exceeding the specified performance ratings and specifications (including but not limited to input and output voltage, current, power, and environmental ranges) for the EVM may cause personal injury or death, or property damage. If there are questions concerning performance ratings and specifications, User should contact a TI field representative prior to connecting interface electronics including input power and intended loads. Any loads applied outside of the specified output range may also result in unintended and/or inaccurate operation and/or possible permanent damage to the EVM and/or interface electronics. Please consult the EVM user guide prior to connecting any load to the EVM output. If there is uncertainty as to the load specification, please contact a TI field representative. During normal operation, even with the inputs and outputs kept within the specified allowable ranges, some circuit components may have elevated case temperatures. These components include but are not limited to linear regulators, switching transistors, pass transistors, current sense resistors, and heat sinks, which can be identified using the information in the associated documentation. When working with the EVM, please be aware that the EVM may become very warm.

4.3.2 EVMs are intended solely for use by technically qualified, professional electronics experts who are familiar with the dangers and application risks associated with handling electrical mechanical components, systems, and subsystems. User assumes all responsibility and liability for proper and safe handling and use of the EVM by User or its employees, affiliates, contractors or designees. User assumes all responsibility and liability to ensure that any interfaces (electronic and/or mechanical) between the EVM and any human body are designed with suitable isolation and means to safely limit accessible leakage currents to minimize the risk of electrical shock hazard. User assumes all responsibility and liability for any improper or unsafe handling or use of the EVM by User or its employees, affiliates, contractors or designees.

4.4 User assumes all responsibility and liability to determine whether the EVM is subject to any applicable international, federal, state, or local laws and regulations related to User's handling and use of the EVM and, if applicable, User assumes all responsibility and liability for compliance in all respects with such laws and regulations. User assumes all responsibility and liability for proper disposal and recycling of the EVM consistent with all applicable international, federal, state, and local requirements.

5. *Accuracy of Information:* To the extent TI provides information on the availability and function of EVMs, TI attempts to be as accurate as possible. However, TI does not warrant the accuracy of EVM descriptions, EVM availability or other information on its websites as accurate, complete, reliable, current, or error-free.

6. *Disclaimers:*

6.1 EXCEPT AS SET FORTH ABOVE, EVMS AND ANY MATERIALS PROVIDED WITH THE EVM (INCLUDING, BUT NOT LIMITED TO, REFERENCE DESIGNS AND THE DESIGN OF THE EVM ITSELF) ARE PROVIDED "AS IS" AND "WITH ALL FAULTS." TI DISCLAIMS ALL OTHER WARRANTIES, EXPRESS OR IMPLIED, REGARDING SUCH ITEMS, INCLUDING BUT NOT LIMITED TO ANY EPIDEMIC FAILURE WARRANTY OR IMPLIED WARRANTIES OF MERCHANTABILITY OR FITNESS FOR A PARTICULAR PURPOSE OR NON-INFRINGEMENT OF ANY THIRD PARTY PATENTS, COPYRIGHTS, TRADE SECRETS OR OTHER INTELLECTUAL PROPERTY RIGHTS.

6.2 EXCEPT FOR THE LIMITED RIGHT TO USE THE EVM SET FORTH HEREIN, NOTHING IN THESE TERMS SHALL BE CONSTRUED AS GRANTING OR CONFERRING ANY RIGHTS BY LICENSE, PATENT, OR ANY OTHER INDUSTRIAL OR INTELLECTUAL PROPERTY RIGHT OF TI, ITS SUPPLIERS/LICENSORS OR ANY OTHER THIRD PARTY, TO USE THE EVM IN ANY FINISHED END-USER OR READY-TO-USE FINAL PRODUCT, OR FOR ANY INVENTION, DISCOVERY OR IMPROVEMENT, REGARDLESS OF WHEN MADE, CONCEIVED OR ACQUIRED.

7. *USER'S INDEMNITY OBLIGATIONS AND REPRESENTATIONS.* USER WILL DEFEND, INDEMNIFY AND HOLD TI, ITS LICENSORS AND THEIR REPRESENTATIVES HARMLESS FROM AND AGAINST ANY AND ALL CLAIMS, DAMAGES, LOSSES, EXPENSES, COSTS AND LIABILITIES (COLLECTIVELY, "CLAIMS") ARISING OUT OF OR IN CONNECTION WITH ANY HANDLING OR USE OF THE EVM THAT IS NOT IN ACCORDANCE WITH THESE TERMS. THIS OBLIGATION SHALL APPLY WHETHER CLAIMS ARISE UNDER STATUTE, REGULATION, OR THE LAW OF TORT, CONTRACT OR ANY OTHER LEGAL THEORY, AND EVEN IF THE EVM FAILS TO PERFORM AS DESCRIBED OR EXPECTED.

8. *Limitations on Damages and Liability:*

8.1 *General Limitations.* IN NO EVENT SHALL TI BE LIABLE FOR ANY SPECIAL, COLLATERAL, INDIRECT, PUNITIVE, INCIDENTAL, CONSEQUENTIAL, OR EXEMPLARY DAMAGES IN CONNECTION WITH OR ARISING OUT OF THESE TERMS OR THE USE OF THE EVMS, REGARDLESS OF WHETHER TI HAS BEEN ADVISED OF THE POSSIBILITY OF SUCH DAMAGES. EXCLUDED DAMAGES INCLUDE, BUT ARE NOT LIMITED TO, COST OF REMOVAL OR REINSTALLATION, ANCILLARY COSTS TO THE PROCUREMENT OF SUBSTITUTE GOODS OR SERVICES, RETESTING, OUTSIDE COMPUTER TIME, LABOR COSTS, LOSS OF GOODWILL, LOSS OF PROFITS, LOSS OF SAVINGS, LOSS OF USE, LOSS OF DATA, OR BUSINESS INTERRUPTION. NO CLAIM, SUIT OR ACTION SHALL BE BROUGHT AGAINST TI MORE THAN TWELVE (12) MONTHS AFTER THE EVENT THAT GAVE RISE TO THE CAUSE OF ACTION HAS OCCURRED.

8.2 *Specific Limitations.* IN NO EVENT SHALL TI'S AGGREGATE LIABILITY FROM ANY USE OF AN EVM PROVIDED HEREUNDER, INCLUDING FROM ANY WARRANTY, INDEMNITY OR OTHER OBLIGATION ARISING OUT OF OR IN CONNECTION WITH THESE TERMS, EXCEED THE TOTAL AMOUNT PAID TO TI BY USER FOR THE PARTICULAR EVM(S) AT ISSUE DURING THE PRIOR TWELVE (12) MONTHS WITH RESPECT TO WHICH LOSSES OR DAMAGES ARE CLAIMED. THE EXISTENCE OF MORE THAN ONE CLAIM SHALL NOT ENLARGE OR EXTEND THIS LIMIT.

9. *Return Policy.* Except as otherwise provided, TI does not offer any refunds, returns, or exchanges. Furthermore, no return of EVM(s) will be accepted if the package has been opened and no return of the EVM(s) will be accepted if they are damaged or otherwise not in a resalable condition. If User feels it has been incorrectly charged for the EVM(s) it ordered or that delivery violates the applicable order, User should contact TI. All refunds will be made in full within thirty (30) working days from the return of the components(s), excluding any postage or packaging costs.

10. *Governing Law:* These terms and conditions shall be governed by and interpreted in accordance with the laws of the State of Texas, without reference to conflict-of-laws principles. User agrees that non-exclusive jurisdiction for any dispute arising out of or relating to these terms and conditions lies within courts located in the State of Texas and consents to venue in Dallas County, Texas. Notwithstanding the foregoing, any judgment may be enforced in any United States or foreign court, and TI may seek injunctive relief in any United States or foreign court.

IMPORTANT NOTICE FOR TI DESIGN INFORMATION AND RESOURCES

Texas Instruments Incorporated ("TI") technical, application or other design advice, services or information, including, but not limited to, reference designs and materials relating to evaluation modules, (collectively, "TI Resources") are intended to assist designers who are developing applications that incorporate TI products; by downloading, accessing or using any particular TI Resource in any way, you (individually or, if you are acting on behalf of a company, your company) agree to use it solely for this purpose and subject to the terms of this Notice.

TI's provision of TI Resources does not expand or otherwise alter TI's applicable published warranties or warranty disclaimers for TI products, and no additional obligations or liabilities arise from TI providing such TI Resources. TI reserves the right to make corrections, enhancements, improvements and other changes to its TI Resources.

You understand and agree that you remain responsible for using your independent analysis, evaluation and judgment in designing your applications and that you have full and exclusive responsibility to assure the safety of your applications and compliance of your applications (and of all TI products used in or for your applications) with all applicable regulations, laws and other applicable requirements. You represent that, with respect to your applications, you have all the necessary expertise to create and implement safeguards that (1) anticipate dangerous consequences of failures, (2) monitor failures and their consequences, and (3) lessen the likelihood of failures that might cause harm and take appropriate actions. You agree that prior to using or distributing any applications that include TI products, you will thoroughly test such applications and the functionality of such TI products as used in such applications. TI has not conducted any testing other than that specifically described in the published documentation for a particular TI Resource.

You are authorized to use, copy and modify any individual TI Resource only in connection with the development of applications that include the TI product(s) identified in such TI Resource. NO OTHER LICENSE, EXPRESS OR IMPLIED, BY ESTOPPEL OR OTHERWISE TO ANY OTHER TI INTELLECTUAL PROPERTY RIGHT, AND NO LICENSE TO ANY TECHNOLOGY OR INTELLECTUAL PROPERTY RIGHT OF TI OR ANY THIRD PARTY IS GRANTED HEREIN, including but not limited to any patent right, copyright, mask work right, or other intellectual property right relating to any combination, machine, or process in which TI products or services are used. Information regarding or referencing third-party products or services does not constitute a license to use such products or services, or a warranty or endorsement thereof. Use of TI Resources may require a license from a third party under the patents or other intellectual property of the third party, or a license from TI under the patents or other intellectual property of TI.

TI RESOURCES ARE PROVIDED "AS IS" AND WITH ALL FAULTS. TI DISCLAIMS ALL OTHER WARRANTIES OR REPRESENTATIONS, EXPRESS OR IMPLIED, REGARDING TI RESOURCES OR USE THEREOF, INCLUDING BUT NOT LIMITED TO ACCURACY OR COMPLETENESS, TITLE, ANY EPIDEMIC FAILURE WARRANTY AND ANY IMPLIED WARRANTIES OF MERCHANTABILITY, FITNESS FOR A PARTICULAR PURPOSE, AND NON-INFRINGEMENT OF ANY THIRD PARTY INTELLECTUAL PROPERTY RIGHTS.

TI SHALL NOT BE LIABLE FOR AND SHALL NOT DEFEND OR INDEMNIFY YOU AGAINST ANY CLAIM, INCLUDING BUT NOT LIMITED TO ANY INFRINGEMENT CLAIM THAT RELATES TO OR IS BASED ON ANY COMBINATION OF PRODUCTS EVEN IF DESCRIBED IN TI RESOURCES OR OTHERWISE. IN NO EVENT SHALL TI BE LIABLE FOR ANY ACTUAL, DIRECT, SPECIAL, COLLATERAL, INDIRECT, PUNITIVE, INCIDENTAL, CONSEQUENTIAL OR EXEMPLARY DAMAGES IN CONNECTION WITH OR ARISING OUT OF TI RESOURCES OR USE THEREOF, AND REGARDLESS OF WHETHER TI HAS BEEN ADVISED OF THE POSSIBILITY OF SUCH DAMAGES.

You agree to fully indemnify TI and its representatives against any damages, costs, losses, and/or liabilities arising out of your non-compliance with the terms and provisions of this Notice.

This Notice applies to TI Resources. Additional terms apply to the use and purchase of certain types of materials, TI products and services. These include; without limitation, TI's standard terms for semiconductor products (<http://www.ti.com/sc/docs/stdterms.htm>), [evaluation modules](#), and [samples](http://www.ti.com/sc/docs/sampterm.htm) (<http://www.ti.com/sc/docs/sampterm.htm>).

Mailing Address: Texas Instruments, Post Office Box 655303, Dallas, Texas 75265
Copyright © 2017, Texas Instruments Incorporated