

**MOTOROLA SEMICONDUCTOR TECHNICAL DATA**

**NPN  
BD785, BD787  
PNP  
BD786, BD788**

**COMPLEMENTARY PLASTIC SILICON ANNULAR POWER TRANSISTORS**

... designed for low power audio amplifier and low current, high-speed switching applications.

- Low Collector-Emitter Sustaining Voltage –  
V<sub>CEO</sub> (sus) 45 Vdc (Min) – BD785, BD786  
60 Vdc (Min) – BD787, BD788
- High Current-Gain – Bandwidth Product –  
f<sub>T</sub> = 50 MHz (Min) @ I<sub>C</sub> = 100 mAdc
- DC Current Gain Specified at 0.2, 1.0, 2.0 and 4.0 Adc
- Collector-Emitter Saturation Voltage Specified at 0.5, 1.0, 2.0 and 4.0 Adc

**4 AMPERE  
POWER TRANSISTORS  
COMPLEMENTARY SILICON  
45, 60VOLTS  
15 WATTS**

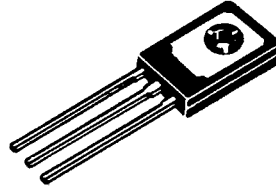

**\*MAXIMUM RATINGS**

Rating	Symbol	BD785 BD786	BD787 BD788	Unit
Collector-Emitter Voltage	V <sub>CEO</sub>	45	60	Vdc
Collector-Base Voltage	V <sub>CB0</sub>	60	80	Vdc
Emitter-Base Voltage	V <sub>EB0</sub>	6.0		Vdc
Collector Current – Continuous	I <sub>C</sub>	4.0		Adc
– Peak		8.0		Adc
Base Current	I <sub>B</sub>	1.0		Adc
Total Power Dissipation @ T <sub>C</sub> = 25°C	P <sub>D</sub>	15		Watts
Derate Above 25°C		0.12		W/°C
Operating and Storage Junction Temperature Range	T <sub>J</sub> , T <sub>stg</sub>	-65 to +150		°C

**THERMAL CHARACTERISTICS**

Characteristic	Symbol	Max	Unit
Thermal Resistance, Junction to Case	R <sub>θJC</sub>	8.34	°C/W

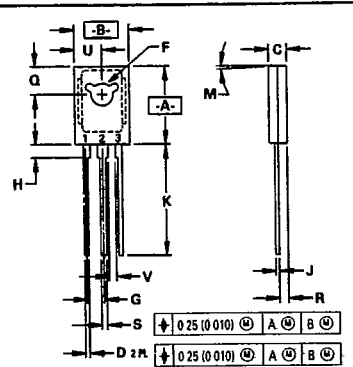

NOTES:  
1. DIMENSIONING AND TOLERANCING PER ANSI Y14.5M, 1982.  
2. CONTROLLING DIMENSION: INCH.

DIM	MILLIMETERS		INCHES	
	MIN	MAX	MIN	MAX
A	10.80	11.04	0.425	0.435
B	7.50	7.74	0.295	0.305
C	2.42	2.66	0.095	0.105
D	0.51	0.66	0.020	0.026
F	2.93	3.17	0.115	0.125
G	2.39 BSC		0.094 BSC	
H	1.27	2.41	0.050	0.095
J	0.39	0.63	0.015	0.025
K	14.61	16.63	0.575	0.655
M	3° TYP		3° TYP	
Q	3.76	4.01	0.148	0.158
R	1.15	1.39	0.045	0.055
S	0.64	0.88	0.025	0.035
U	3.69	3.93	0.145	0.155
V	1.02	—	0.040	—

STYLE 1:  
PIN 1. EMITTER  
2. COLLECTOR  
3. BASE

CASE 77-06  
TO-225AA TYPE

3

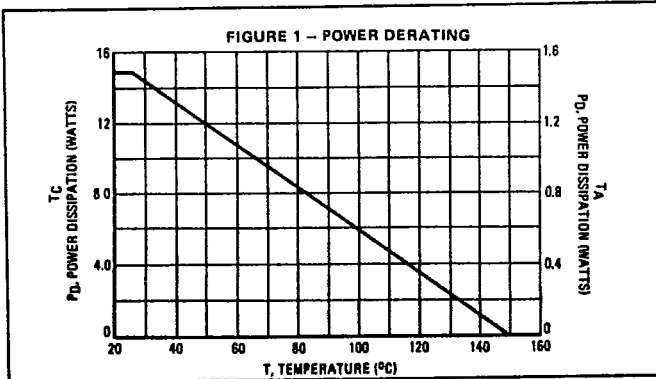

BD785, BD787 NPN  
BD786, BD788 PNP

T-33-07  
T-33-17

\*ELECTRICAL CHARACTERISTICS (T<sub>C</sub> = 25°C unless otherwise noted.)

Characteristic	Symbol	Min	Max	Unit
<b>OFF CHARACTERISTICS</b>				
Collector-Emitter Sustaining Voltage (1) (I <sub>C</sub> = 10 mA, I <sub>B</sub> = 0)	V <sub>CE(sus)</sub>	45	-	Vdc
BD785, BD786		60	-	
BD787, BD788				
Collector Cutoff Current (V <sub>CE</sub> = 20 Vdc, I <sub>B</sub> = 0)	I <sub>CEO</sub>	-	100	μA
(V <sub>CE</sub> = 30 Vdc, I <sub>B</sub> = 0)		-	100	
Collector Cutoff Current (V <sub>CE</sub> = 60 Vdc, V <sub>BE(off)</sub> = 1.5 Vdc)	I <sub>CEX</sub>	-	1.0	μA
BD785, BD786		-	1.0	
BD787, BD788		-	1.0	
(V <sub>CE</sub> = 80 Vdc, V <sub>BE(off)</sub> = 1.5 Vdc)		-	1.0	
(V <sub>CE</sub> = 30 Vdc, V <sub>BE(off)</sub> = 1.5 Vdc, T <sub>C</sub> = 125°C)		-	0.1	mA
BD785, BD786		-	0.1	
BD787, BD788		-	0.1	
(V <sub>CE</sub> = 40 Vdc, V <sub>BE(off)</sub> = 1.5 Vdc, T <sub>C</sub> = 125°C)		-	0.1	
Emitter Cutoff Current (V <sub>EB</sub> = 6.0 Vdc, I <sub>C</sub> = 0)	I <sub>EBO</sub>	-	1.0	μA
<b>ON CHARACTERISTICS (1)</b>				
DC Current Gain (I <sub>C</sub> = 200 mA, V <sub>CE</sub> = 3.0 Vdc)	h <sub>FE</sub>	40	250	-
(I <sub>C</sub> = 1.0 A, V <sub>CE</sub> = 3.0 Vdc)		25	-	
(I <sub>C</sub> = 2.0 A, V <sub>CE</sub> = 3.0 Vdc)		20	-	
(I <sub>C</sub> = 4.0 A, V <sub>CE</sub> = 3.0 Vdc)		5.0	-	
Collector-Emitter Saturation Voltage (I <sub>C</sub> = 500 mA, I <sub>B</sub> = 50 mA)	V <sub>CE(sat)</sub>	-	0.4	Vdc
(I <sub>C</sub> = 1.0 A, I <sub>B</sub> = 100 mA)		-	0.6	
(I <sub>C</sub> = 2.0 A, I <sub>B</sub> = 200 mA)		-	0.8	
(I <sub>C</sub> = 4.0 A, I <sub>B</sub> = 800 mA)		-	2.5	
Base-Emitter Saturation Voltage (I <sub>C</sub> = 2.0 A, I <sub>B</sub> = 200 mA)	V <sub>BE(sat)</sub>	-	2.0	Vdc
Base-Emitter on Voltage (I <sub>C</sub> = 2.0 A, V <sub>CE</sub> = 3.0 Vdc)	V <sub>BE(on)</sub>	-	1.8	Vdc
<b>DYNAMIC CHARACTERISTICS</b>				
Current-Gain - Bandwidth Product (I <sub>C</sub> = 100 mA, V <sub>CE</sub> = 10 Vdc, f = 10 MHz)	f <sub>T</sub>	50	-	MHz
Output Capacitance (V <sub>CB</sub> = 10 Vdc, I <sub>C</sub> = 0)	C <sub>ob</sub>	-	50	pF
f = 0.1 MHz		-	70	
Small-Signal Current Gain (I <sub>C</sub> = 200 mA, V <sub>CE</sub> = 10 Vdc, f = 1.0 kHz)	h <sub>fe</sub>	10	-	-

\*Indicates JEDEC Registered Data.

(1) Pulse Test: Pulse Width ≤ 300 μs, Duty Cycle ≤ 2.0%

FIGURE 2 - SWITCHING TIME TEST CIRCUIT

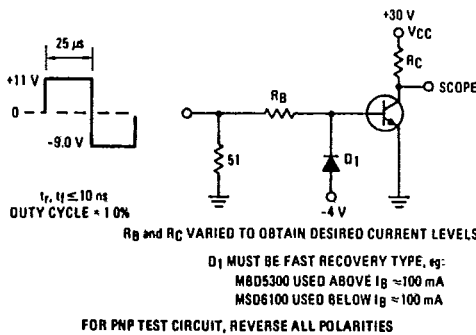
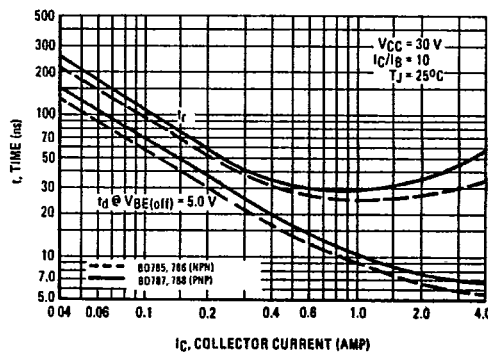

FIGURE 3 - TURN-ON TIME



3

BD785, BD787 NPN  
BD786, BD788 PNP

T-33-07

T-33-17

FIGURE 4 - THERMAL RESPONSE

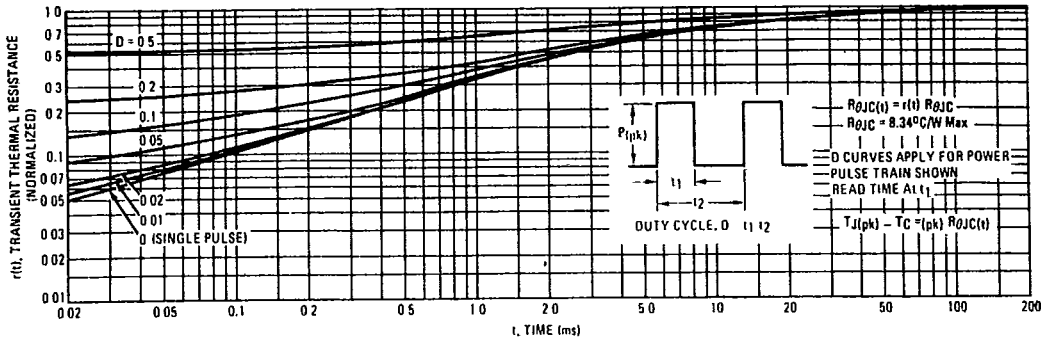
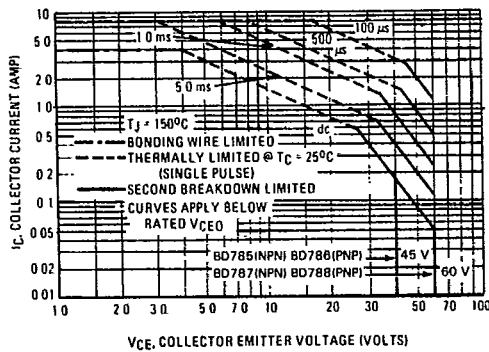

FIGURE 5 - ACTIVE-REGION SAFE OPERATING AREA



There are two limitations on the power handling ability of a transistor - average junction temperature and second breakdown. Safe operating area curves indicate  $I_C$ - $V_{CE}$  limits of the transistor that must be observed for reliable operation, i.e., the transistor must not be subjected to greater dissipation than the curves indicate.

The data of Figure 5 is based on  $T_{j(pk)} = 150^\circ\text{C}$ ;  $T_C$  is variable depending on conditions. Second breakdown pulse limits are valid for duty cycles to 10% provided  $T_{j(pk)} \leq 150^\circ\text{C}$ .  $T_{j(pk)}$  may be calculated from the data in Figure 4. At high case temperatures, thermal limitations will reduce the power that can be handled to values less than the limitations imposed by second breakdown (See AN 415A).

FIGURE 6 - TURN-OFF TIME

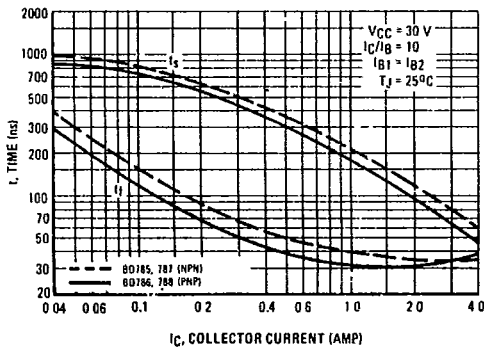
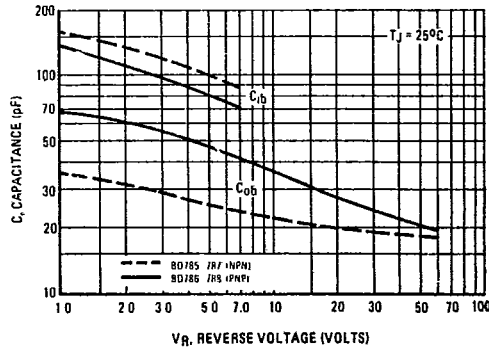

FIGURE 7 - CAPACITANCE



BD785, BD787 NPN  
BD786, BD788 PNP

T-33-07  
T-33-17

NPN  
BD785, BD787

PNP  
BD786, BD788

FIGURE 8 - DC CURRENT GAIN

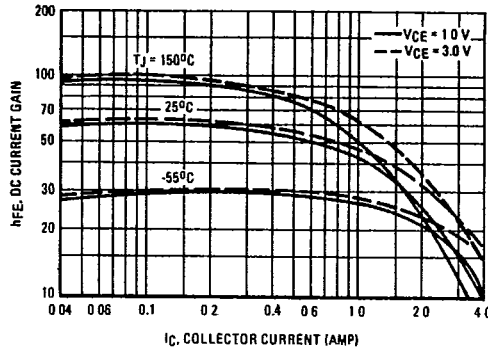
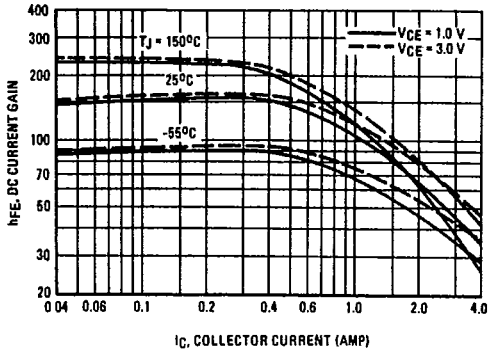
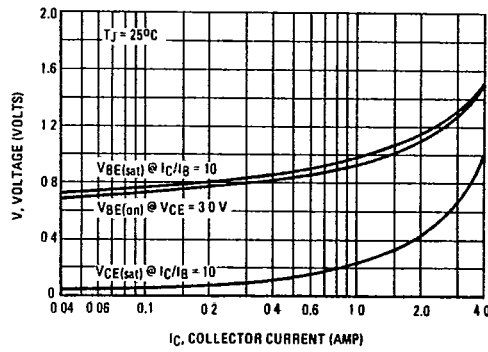
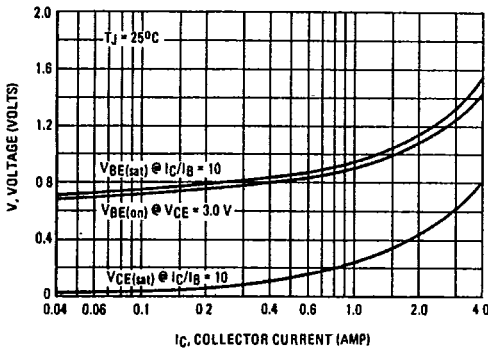

FIGURE 9 - "ON" VOLTAGES



3

FIGURE 10 - TEMPERATURE COEFFICIENTS

