

NINJA F/FX (ADM6992F/FX)

Fiber to Fast Ethernet Converter

Communications



Never stop thinking.

Edition 2005-11-25

**Published by Infineon Technologies AG,
St.-Martin-Strasse 53,
81669 München, Germany**

**© Infineon Technologies AG 2005.
All Rights Reserved.**

Attention please!

The information herein is given to describe certain components and shall not be considered as a guarantee of characteristics.

Terms of delivery and rights to technical change reserved.

We hereby disclaim any and all warranties, including but not limited to warranties of non-infringement, regarding circuits, descriptions and charts stated herein.

Information

For further information on technology, delivery terms and conditions and prices please contact your nearest Infineon Technologies Office (www.infineon.com).

Warnings

Due to technical requirements components may contain dangerous substances. For information on the types in question please contact your nearest Infineon Technologies Office.

Infineon Technologies Components may only be used in life-support devices or systems with the express written approval of Infineon Technologies, if a failure of such components can reasonably be expected to cause the failure of that life-support device or system, or to affect the safety or effectiveness of that device or system. Life support devices or systems are intended to be implanted in the human body, or to support and/or maintain and sustain and/or protect human life. If they fail, it is reasonable to assume that the health of the user or other persons may be endangered.

Fiber to Fast Ethernet Converter

Revision History: 2005-11-25, Rev. 1.02

Previous Version:

Page/Date	Subjects (major changes since last revision)
2004-04-02	Rev.1.0, First release of NINJA F (ADM6992F)
2005-09-09	Changed to the new Infineon format
2005-09-09	Rev.1.01 when changed to the new Infineon format
2005-11-25	Rev. 1.01 changed to Rev. 1.02 Minor change. Included Green package information

Trademarks

ABM[®], ACE[®], AOP[®], ARCOFI[®], ASM[®], ASP[®], DigiTape[®], DuSLIC[®], EPIC[®], ELIC[®], FALC[®], GEMINAX[®], IDEC[®], INCA[®], IOM[®], IPAT[®]-2, ISAC[®], ITAC[®], IWE[®], IWORX[®], MUSAC[®], MuSLIC[®], OCTAT[®], OptiPort[®], POTSWIRE[®], QUAT[®], QuadFALC[®], SCOUT[®], SICAT[®], SICOFI[®], SIDEC[®], SLICOFI[®], SMINT[®], SOCRATES[®], VINETIC[®], 10BaseV[®], 10BaseVX[®] are registered trademarks of Infineon Technologies AG. 10BaseS[™], EasyPort[™], VDSLite[™] are trademarks of Infineon Technologies AG. Microsoft[®] is a registered trademark of Microsoft Corporation, Linux[®] of Linus Torvalds, Visio[®] of Visio Corporation, and FrameMaker[®] of Adobe Systems Incorporated.

Table of Contents

	Table of Contents	4
	List of Figures	6
	List of Tables	7
1	Product Overview	8
1.1	Overview	8
1.2	Features	8
1.3	Block Diagram	9
1.4	Data Lengths Conventions	9
2	Interface Description	10
2.1	Pin Diagram	10
2.2	Pin Type and Buffer Type Abbreviations	11
2.3	Pin Descriptions	12
3	Function Description	19
3.1	OAM Engine	19
3.2	10/100M PHY Block	19
3.3	Auto Negotiation and Speed Configuration	20
3.3.1	Auto Negotiation	20
3.3.2	Speed Configuration	20
3.4	Switch Functional Description	21
3.4.1	Store & Forward Mode	21
3.4.2	Modified Cut-through Mode	22
3.4.3	MII cut-through Mode	22
3.5	Basic Operations	22
3.5.1	MAC Address Learning & Filtering	22
3.5.2	Address Learning	22
3.5.3	Hash Algorithm	22
3.5.4	Address Recognition and Packet Forwarding	23
3.5.5	Address Aging	23
3.5.6	Back off Algorithm	23
3.5.7	Inter-Packet Gap (IPG)	23
3.5.8	Illegal Frames	23
3.5.9	Half Duplex Flow Control	23
3.5.10	Full Duplex Flow Control	24
3.5.11	Bandwidth Control	24
3.5.12	Interrupt	24
3.5.13	Auto TP MDIX function	24
3.6	Converter Functional Description	24
3.6.1	OAM Buffer	24
3.6.2	OAM frame transmit	25
3.6.3	Power failure detection	25
3.6.4	Automatic User Frame Generation	25
3.6.5	Automatic User Frame Comparison	26
3.6.6	Fault Propagation	26
3.6.7	Remote Control	26
3.7	Serial Management Interface (SMI) Register Access	27
3.7.1	Preamble Suppression	28
3.7.2	Read EEPROM Register via SMI Register	28

Table of Contents

3.7.3	Write EEPROM Register via SMI Register	29
3.8	Reset Operation	29
3.8.1	Write EEPROM Register via EEPROM Interface	29
4	Registers Description	30
4.1	EEPROM Registers	30
4.2	EEPROM Register Descriptions	32
4.2.1	EEPROM Register Format	34
4.3	Serial Management Registers	57
4.4	Serial Management Register Descriptions	59
4.4.1	Serial Management Register Format	60
5	Electrical Specification	77
5.1	DC Characterization	77
5.2	AC Characterization	77
6	Packaging	80

List of Figures

Figure 1	NINJA F/FX (ADM6992F/FX) Block Diagram	9
Figure 2	NINJA F/FX (ADM6992F/FX) 64-Pin Assignment	10
Figure 3	SMI Read Operation	27
Figure 4	SMI Write Operation	28
Figure 5	Power on Reset Timing	78
Figure 6	EEPROM Interface Timing	78
Figure 7	SMI Timing	79
Figure 8	128 pin QFP Outside Dimension	80

List of Tables

Table 1	Data Lengths Conventions	9
Table 2	NINJA F/FX (ADM6992F/FX) Abbreviations for Pin Type	11
Table 3	Abbreviations for Buffer Type	11
Table 4	Port 0/1 Twisted Pair Interface (8 Pins)	12
Table 5	LED Interface (12 Pins)	12
Table 6	EEPROM Interface (4 Pins)	15
Table 7	Configuration Interface (28 Pins)	16
Table 8	Ground/Power Interface (27 Pins)	17
Table 9	Miscellaneous (14 Pins)	18
Table 10	Speed Configuration	21
Table 11	OAM Delivery Between CO and CPE	26
Table 12	SMI Read/Write Command Format	27
Table 13	EEPROM Register Map	30
Table 14	Registers Address Space	32
Table 15	Registers Overview	32
Table 16	Register Access Types	33
Table 17	Registers Clock Domains	34
Table 18	Other Packet Filter Control Registers	45
Table 19	Other Filter Registers	47
Table 20	Other Tag Port Rule 0 Registers	50
Table 21	Other Tag Port Rule 1 Registers	51
Table 22	Serial Management Register Map	57
Table 23	Registers Address Space	59
Table 24	Registers Overview	59
Table 25	Register Access Types	60
Table 26	Registers Clock Domains	60
Table 27	Other Counter Registers	62
Table 28	Electrical Absolute Maximum Rating	77
Table 29	Recommended Operating Conditions	77
Table 30	DC Electrical Characteristics for 3.3 V Operation	77
Table 31	Power on Reset Timing	78
Table 32	EEPROM Interface Timing	78
Table 33	SMI Timing	79
Table 34	Dimensions for 128 PQFP Outside Dimension	81

1 Product Overview

Features and the block diagram.

1.1 Overview

The NINJA F/FX (ADM6992F/FX) is a single chip integrating two 10/100 Mbps MDIX TX/FX transceivers with a two-port 10/100M Ethernet L2 switch controller. Features include a converter mode to meet demanding applications, such as Fiber-to-Ethernet media converters and FTTH (Fiber to the Home), on the CPE and CO sides. The ADM6992FX is the environmentally friendly “green” package version.

The NINJA F/FX (ADM6992F/FX) supports 16 entries of packet classification and marking or filtering for TCP/UDP port numbering, IP protocol ID and Ethernet Types. These can be configured either using the EEPROM or on the fly using a small, low-cost micro controller.

On the media side, the NINJA F/FX (ADM6992F/FX)'s ports 0 and 1 support auto-MDIX 10Base-T/100Base-TX and 100Base-FX as specified by the IEEE 802.3 committee through uses of digital circuitry and high speed A/D. The NINJA F/FX (ADM6992F/FX) also supports a serial management interface (SMI), which is initialized and configured using a small low-cost micro controller. It also provides the port status for remote agent monitoring and a smart counter for reporting port statistics. Users can implement TS-1000 CO side functions through this SMI interface.

1.2 Features

Main features:

- 2-port 10/100M switch integrated with a 2-port PHY (10/100TX and 100FX)
- Embedded OAM engine complying with TS1000 for CPE and CO functions
- Supports remote control via an OAM frame.
- Provides TX<-->FX Converter modes with Link Pass Through (LPT)
- Built-in data buffer 6Kx64bit SRAM
- Up to 1k of Unicast. MAC addresses with a 4-way associative hashing table
- MAC address learning table with aging function
- Supports store & forward frame forwarding, modify cut-through frame forwarding, and fast cut-through frame forwarding.
- Forwarding and filtering at non-blocking full wire speed
- 802.3x flow control for full duplex and back-pressure for half duplex
- Supports Auto-Negotiation
- Supports Auto Cross-Over
- Packet lengths up to 9216 bytes.
- 16 entries of packet classification and marking or filtering for TCP/UDP Port Numbering, IP Protocol ID and Ethernet Type
- Serial Management Interface for low-end CPUs
- OAM frame can be monitored/generated via SMI interface
- Hardware bandwidth control support for both ingress/egress traffic
- Provides port status for remote agent monitoring
- Provides smart counters for port statistics reporting
- 128 PQFP packaging with 1.8 V/3.3 V power supply

1.3 Block Diagram

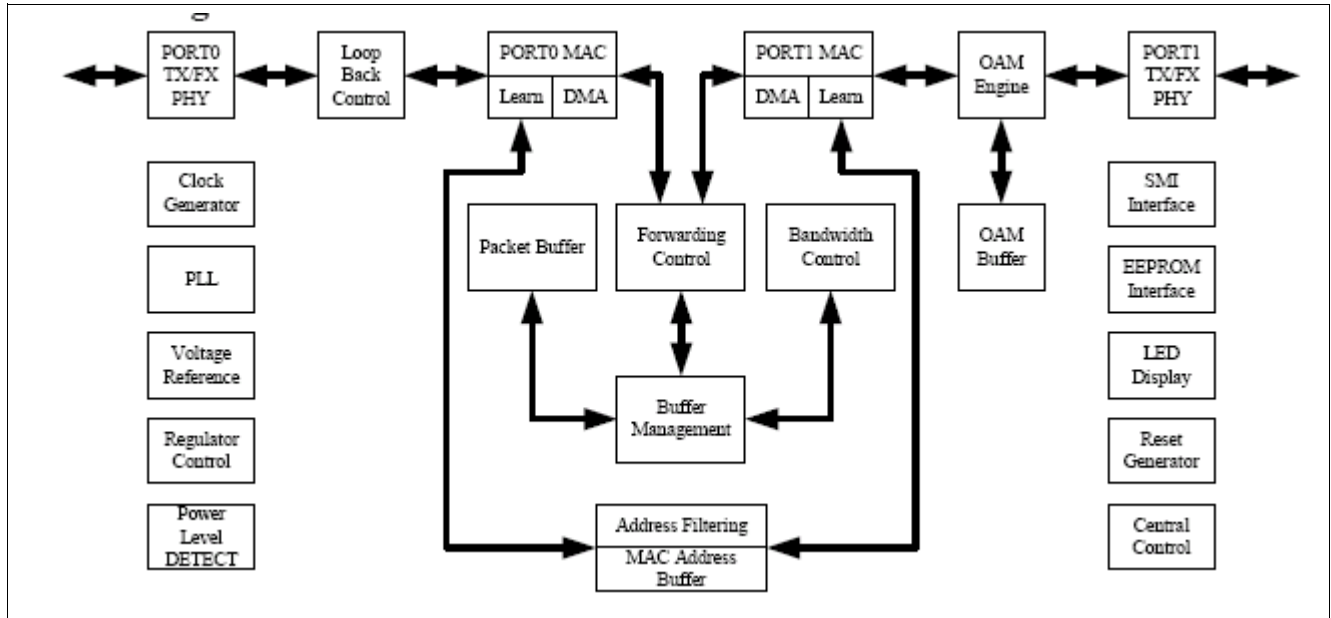

Figure 1 NINJA F/FX (ADM6992F/FX) Block Diagram

1.4 Data Lengths Conventions

Table 1 Data Lengths Conventions

qword	64 bits
dword	32 bits
word	16 bits
byte	8 bits
nibble	4 bits

2 Interface Description

This chapter describes Pin Diagram, Pin Type and Buffer Type Abbreviations, and Pin Descriptions.

2.1 Pin Diagram

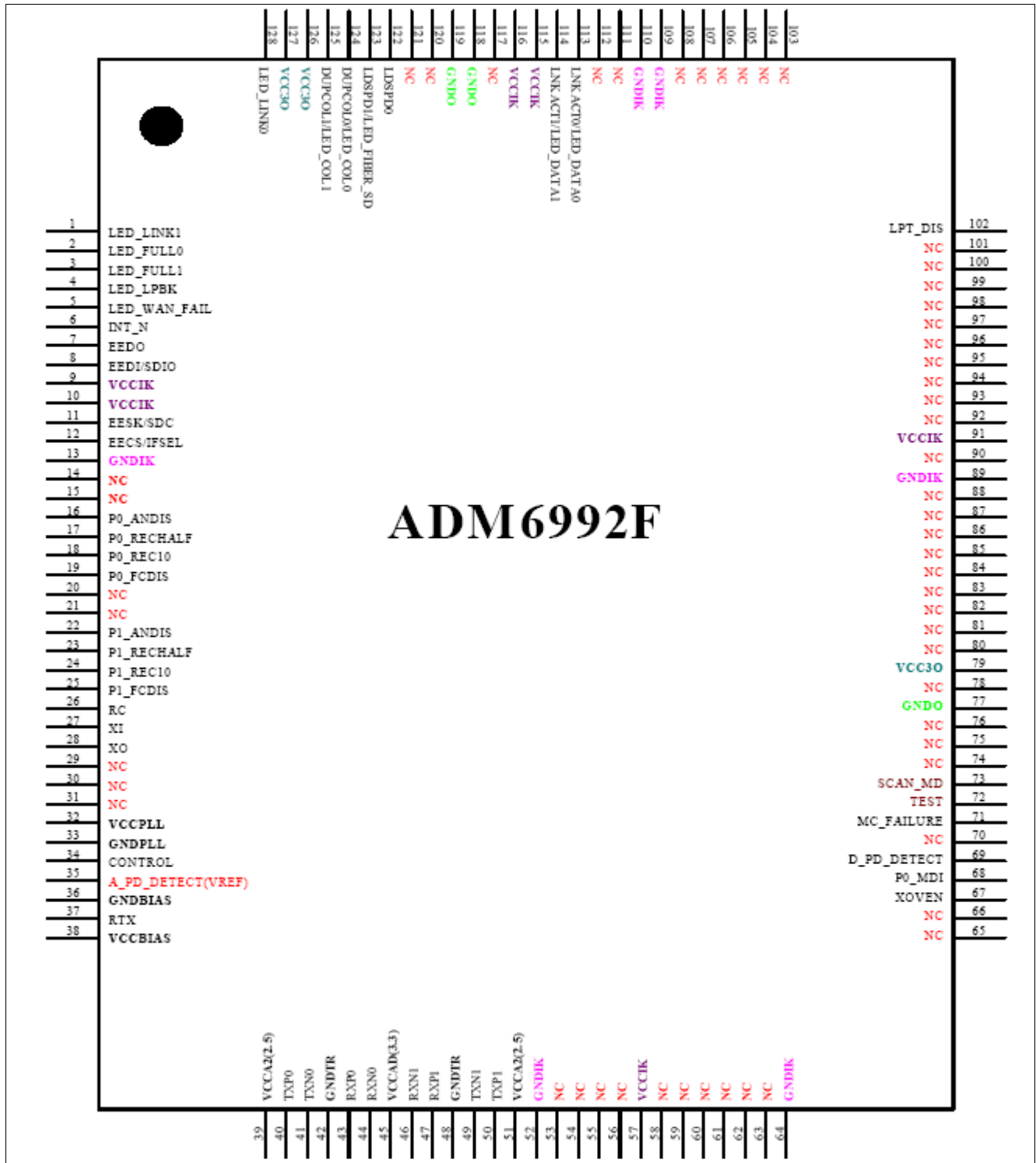

Figure 2 NINJA F/FX (ADM6992F/FX) 64-Pin Assignment

2.2 Pin Type and Buffer Type Abbreviations

Standardized abbreviations:

Table 2 NINJA F/FX (ADM6992F/FX) Abbreviations for Pin Type

Abbreviations	Description
I	Standard input-only pin. Digital levels.
O	Output. Digital levels.
I/O	I/O is a bidirectional input/output signal.
AI	Input. Analog levels.
AO	Output. Analog levels.
AI/O	Input or Output. Analog levels.
PWR	Power
GND	Ground
MCL	Must be connected to Low (JEDEC Standard)
MCH	Must be connected to High (JEDEC Standard)
NU	Not Usable (JEDEC Standard)
NC	Not Connected (JEDEC Standard)

Table 3 Abbreviations for Buffer Type

Abbreviations	Description
Z	High impedance
PU1	Pull up, 10 k Ω
PD1	Pull down, 10 k Ω
PD2	Pull down, 20 k Ω
TS	Tristate capability: The corresponding pin has 3 operational states: Low, high and high-impedance.
OD	Open Drain. The corresponding pin has 2 operational states, active low and tristate, and allows multiple devices to share as a wire-OR. An external pull-up is required to sustain the inactive state until another agent drives it, and must be provided by the central resource.
OC	Open Collector
PP	Push-Pull. The corresponding pin has 2 operational states: Active-low and active-high (identical to output with no type attribute).
OD/PP	Open-Drain or Push-Pull. The corresponding pin can be configured either as an output with the OD attribute or as an output with the PP attribute.
ST	Schmitt-Trigger characteristics
TTL	TTL characteristics

2.3 Pin Descriptions

NINJA F/FX (ADM6992F/FX) pins are categorized into one of the following groups:

- Port 0/1 Twisted Pair Interface, 8 pins
- LED Interface, 12 pins
- EEPROM Interface, 4 pins
- Configuration Interface, 28 pins
- Ground/Power Interface, 27 pins
- Miscellaneous, 14 pins

Note: If not specified, all signals default to digital signals.

Table 4 Port 0/1 Twisted Pair Interface (8 Pins)

Pin or Ball No.	Name	Pin Type	Buffer Type	Function
40	TXP_0	A/I/O		Twisted Pair Transmit Output Positive.
50	TXP_1	A/I/O		
41	TXN_0	A/I/O		Twisted Pair Transmit Output Negative.
49	TXN_1	A/I/O		
43	RXP_0	A/I/O		Twisted Pair Receive Input Positive.
47	RXP_1	A/I/O		
44	RXN_0	A/I/O		Twisted Pair Receive Input Negative.
46	RXN_1	A/I/O		

Table 5 LED Interface (12 Pins)

Pin or Ball No.	Name	Pin Type	Buffer Type	Function
113	LNKACT_0	I/O	TTL PD 8mA	PORT0 Link & Active LED/Link LED. If LEDMODE_0 is 1, this pin indicates both link status and RX/TX activity. When link status is LINK_UP, LNKACT_0 will be turned on. While PORT0 is receiving/transmitting data, LNKACT_0 will be off for 100ms and then on for 100ms. If LEDMODE_0 is 0, this pin only indicates RX/TX activity.
	LED_DATA_0			
	LEDMODE_0			LED mode for LINK/ACT LED of PORT0. During power on reset, value will be latched by NINJA F/FX (ADM6992F/FX) at the rising edge of RESETL as LEDMODE_0.

Table 5 LED Interface (12 Pins) (cont'd)

Pin or Ball No.	Name	Pin Type	Buffer Type	Function
114	LNKACT_1	I/O	TTL PD 8mA	PORT1 Link & Active LED/Link LED. If LEDMODE_2 is 1, this pin indicates both link status and RX/TX activity. When link status is LINK_UP, LNKACT_1 will be turned on. While PORT1 is receiving/transmitting data, LNKACT_1 will be off for 100ms and then on for 100ms. If LEDMODE_2 is 0, this pin only indicates RX/TX activity.
	LED_DATA_1			
	LEDMODE_1			LED mode DUPLEX/COL LED of PORT0 & PORT1. During power on reset, value will be latched by NINJA F/FX (ADM6992F/FX) at the rising edge of RESETL as LEDMODE_1. If LEDMODE_1 is 1, DUPCOL[1:0] will display both duplex condition and collision status. If LEDMODE[1] is 0, only collision status will be displayed.
124	DUPCOL_0	I/O	TTL PD 8mA	PORT0 Duplex LED If LEDMODE_1 is 1, this pin indicates both duplex condition and collision status. When FULL_DUPLEX, this pin will be turned on for PORT0. When HALF_DUPLEX and no collision occurs, this pin will be turned off. When HALF_DUPLEX and a collision occurs, this pin will be off for 100ms and then on for 100ms. If LEDMODE_1 is 0, this pin indicates collision status. When in HALF_DUPLEX and a collision occurs, this pin will be off for 100ms and turn on for 100ms.
	LED_COL_0			Port0 Collision LED
	DIS_LEARN			Disable Address Learning. During power on reset, value will be latched by NINJA F/FX (ADM6992F/FX) at the rising edge of RESETL as DIS_LEARN. If DIS_LEARN is 1, MAC address learning will be disabled.
125	DUPCOL_1	I/O	TTL PU 8mA	PORT1 Duplex If LEDMODE_1 is 1, this pin indicates both duplex condition and collision status. When FULL_DUPLEX, this pin will be turned on for PORT1. When HALF_DUPLEX and no collision occurs, this pin will be turned off. When HALF_DUPLEX and a collision occurs, this pin will be off for 100ms and then on for 100ms. If LEDMODE_1 is 0, this pin indicates collision status. When HALF_DUPLEX and a collision occurs, this pin will be off for 100ms and turn on for 100ms.
	LED_COL_1			Port1 Collision LED
	EN_OAM			Enable Internal OAM Frame Processor. During power on reset, value will be latched by NINJA F/FX (ADM6992F/FX) at the rising edge of RESETL as EN_OAM. If EN_OAM is 0, the internal OAM engine will be disabled.

Table 5 LED Interface (12 Pins) (cont'd)

Pin or Ball No.	Name	Pin Type	Buffer Type	Function
122	LDSPD_0	I/O	TTL PD 8mA	PORT0 Speed LED Used to indicate speed status of PORT0. When operating in 100Mbps this pin is turned on, and when operating in 10Mbps this pin is off.
	FXMODE0			FXMODE0 During power on reset, value will be latched by NINJA F/FX (ADM6992F/FX) at the rising edge of RESETL as bit 0 of FXMODE.
123	LDSPD_1	I/O	TTL PD 8mA	PORT1 Speed LED Used to indicate speed status of PORT1. When operating in 100Mbps this pin is turned on, and when operating in 10Mbps this pin is off.
	LED_FIBER_SD			LED_FIBER_SD. Used to indicate signal status of PORT1 when NINJA F/FX (ADM6992F/FX) is operating in converter mode.
	LEDMODE2			LED mode for LINK/ACT LED of PORT1. During power on reset, value will be latched by NINJA F/FX (ADM6992F/FX) at the rising edge of RESETL as LEDMODE2. 0 _B TBD , ACT 1 _B TBD , LINK/ACT
128	LED_LINK_0	I/O	TTL PU 8mA	PORT0 Link LED This pin indicates link status. When Port0 link status is LINK_UP, this pin will be turned on.
	FXMODE1			FXMODE1 During power on reset, value will be latched by NINJA F/FX (ADM6992F/FX) at the rising edge of RESETL as bit 1 of FXMODE. FXMODE [1:0] Interface 00 _B TBD , Both Port0 & Port1 are TP port 01 _B TBD , Port0 is TP port and Port1 is FX port 10 _B TBD , Port0 is TP port and Port1 is FX port (converter mode) 11 _B TBD , Both Port0 & Port1 are FX port
1	LED_LINK_1	I/O	TTL PU 8mA	PORT1 Link LED This pin indicates link status. When Port1 link status is LINK_UP, this pin will be turned on.
	BYPASS_PAUSE			Bypass frame Which destination address is reserved IEEE MAC address. During power on reset, value will be latched by NINJA F/FX (ADM6992F/FX) at the rising edge of RESETL as BYPASS_PAUSE. 0 _B D , Disable 1 _B E , Enable

Table 5 LED Interface (12 Pins) (cont'd)

Pin or Ball No.	Name	Pin Type	Buffer Type	Function
2	LED_FULL_0	I/O	TTL PU 8mA	PORT0 Full Duplex LED This pin indicates current duplex condition of PORT0. When FULL_DUPLEX, this pin will be turned on. When HALF_DUPLEX this pin will be turned off.
	CHIPID_0			Chip ID Bit 0. During power on reset, value will be latched by NINJA F/FX (ADM6992F/FX) at the rising edge of RESETL as CHIPID_0.
3	LED_FULL_1	I/O	TTL PU 8mA	PORT1 Full Duplex LED This pin indicates current duplex condition of PORT1. When FULL_DUPLEX, this pin will be turned on. When HALF_DUPLEX this pin will be turned off.
	CHIPID_1			Chip ID Bit 1 During power on reset, value will be latched by NINJA F/FX (ADM6992F/FX) at the rising edge of RESETL as CHIPID_1. CHIPID_1:CHIPID_0] 0 _B TBD , Master Device 01 _B TBD , Slave Device 1X _B TBD , Slave Device
4	LED_LPBK	I/O	TTL PU 8mA	Loop Back Test LED While performing loop back test this pin is turned on.
	CHIPID_2			Chip ID Bit 2 During power on reset, value will be latched by NINJA F/FX (ADM6992F/FX) at the rising edge of RESETL as CHIPID_2.
5	LED_WAN_FAIL	O	TTL PU 8mA	WAN Fail LED When receiving an OAM frame which has a S2 bit = 1, this pin is turned on.
	DISBP			Disable Back Pressure During power on reset, value will be latched by NINJA F/FX (ADM6992F/FX) at the rising edge of RESETL as DISBP. 0 _B E , Enable back-pressure (Default) 1 _B D , Disable back-pressure

Table 6 EEPROM Interface (4 Pins)

Pin or Ball No.	Name	Pin Type	Buffer Type	Function
7	EEDO	I	TTL PU	EEPROM Data Output Serial data input from EEPROM. This pin is internal pull-up.
12	EECS/IFSEL	I/O	PD 4mA	EEPROM Chip Select This pin is an active high chip enabled for EEPROM. When RESETL is low, it will be tristate. 0 _B SM , Select Serial Management Interface 1 _B EE , Select EEPROM interface

Table 6 EEPROM Interface (4 Pins) (cont'd)

Pin or Ball No.	Name	Pin Type	Buffer Type	Function
11	EECK/SDC	I/O	TTL PU 4mA	Serial Clock This pin is the EEPROM clock source. When RESETL is low, it will be tristate. This pin is internal pull-up. If IFSEL is 1, this pin is used as EECK. If IFSEL is 0, this pin is used as SDC.
8	EEDI	I/O	TTL PU 4mA	EEPROM Serial Data Input This pin is the output for serial data transfer. When RESETL is low, it will be tristate. If IFSEL is 1, this pin is used as EEDI. If IFSEL is 0, this pin is used as SDIO.

Table 7 Configuration Interface (28 Pins)

Pin or Ball No.	Name	Pin Type	Buffer Type	Function
16	P0_ANDIS	I	TTL PD	Auto-Negotiation Disable for PORT0 0 _B E, Enable 1 _B D, Disable
17	P0_RECHALF	I	TTL PD	Recommend Half Duplex Communication for PORT0 0 _B F, Full 1 _B H, Half
18	P0_REC10	I	TTL PD	Recommend 10M for PORT0 0 _B 100, 100M 1 _B 10, 10M
19	P0_FCDIS	I	TTL PD	Flow Control Disable for PORT0 0 _B E, Enable 1 _B D, Disable
22	P1_ANDIS	I	TTL PD	Auto-Negotiation Disable for PORT1 0 _B E, Enable 1 _B D, Disable
23	P1_RECHALF	I	TTL PD	Recommend Half Duplex Communication for PORT1 0 _B F, Full 1 _B H, Half
24	P1_REC10	I	TTL PD	Recommend 10M for PORT1 0 _B 100, 100M 1 _B 10, 10M
25	P1_FCDIS	I	TTL PD	Flow Control Disable for PORT1 0 _B E, Enable 1 _B D, Disable
67	XOVEN	I	TTL PD	Auto-MDIX Enable. 0 _B D, Disable 1 _B E, Enable

Table 7 Configuration Interface (28 Pins) (cont'd)

Pin or Ball No.	Name	Pin Type	Buffer Type	Function
68	PO_MDI	I	TTL PU	MDI/MDIX Control for PORT0 This setting will be ignored if enables Auto-MDIX. 0 _B MDIX , MDIX 1 _B MDI , MDI
69	D_PD_DETECT	I	TTL PD	Digital Power Failure Detected 0 _B N , Normal 1 _B TX , NINJA F/FX (ADM6992F/FX) will transmit an OAM frame to indicate power failure.
71	MC_FAILURE	I	TTL PD	Media Converter (MC) Failure Detected 0 _B N , Normal 1 _B TX , NINJA F/FX (ADM6992F/FX) will transmit an OAM frame to indicate MC failure.
102	LPT_DIS	I	TTL PD	Link Pass Through Disable 0 _B E , Enable 1 _B D , Disable

Table 8 Ground/Power Interface (27 Pins)

Pin or Ball No.	Name	Pin Type	Buffer Type	Function
42, 48	GNDTR	GND, A		Ground Used by AD receiver/transmitter block.
39, 51	VCCA2	PWR, A		1.8 V used for Analogue block
45	VCCAD	PWR, A		3.3 V used for TX line driver
36	GNDBIAS	GND, A		Ground Used by digital substrate
38	VCCBIAS	PWR, A		3.3 V used for bios block
33	GNDPLL	GND, A		Ground used by PLL
32	VCCPLL	PWR, A		1.8 V used for PLL
13, 52, 64, 89, 109, 110	GNDIK	GND, D		Ground used by digital core and pre-driver
9, 10, 57, 91, 115, 116	VCCIK	PWR, D		1.8 V used for digital core and pre-driver
77, 118, 119	GNDO	GND, D		Ground used by digital pad
79, 126, 127	VCC3O	PWR, D		3.3 V used for digital pad.

Table 9 Miscellaneous (14 Pins)

Pin or Ball No.	Name	Pin Type	Buffer Type	Function
6	$\overline{\text{INT}}$	O	TTL OD 4mA	Interrupt This pin will be used to interrupt external management device. When EEPROM register 0x5 Bit [15] is 0, this pin is low-active. When EEPROM register 0x5 Bit [15] is 1, this pin is high-active.
34	CONTROL	AO		FET Control Signal The pin is used to control FET for 3.3 V to 1.8 V regulator.
37	RTX	A		TX Resistor
35	A_PD_DETECT	A		Analog Power Failure Detected < _B TBD, 1.2 V NINJA F/FX (ADM6992F/FX) will transmit an OAM frame to indicate power failure. > _B TBD, 1.2 V Normal
26	RC	I	TTL ST	RC Input for Power On Reset NINJA F/FX (ADM6992F/FX) sample pin RC as RESETL with the clock input from pin XI.
27	XI	AI		25M Crystal Input 25M Crystal Input. Variation is limited to +/- 50ppm.
28	XO	AO		25M Crystal Output When connected to oscillator, this pin should left unconnected.
72	TEST	I	TTL PD	Test pin During power on reset, value will be latched by NINJA F/FX (ADM6992F/FX) at the rising edge of RESETL as TEST. Connect to GND at normal application.
73	SCAN_MD	I	TTL PD	Scan Mode For Test Only. Connect to GND at normal application.

3 Function Description

The NINJA F/FX (ADM6992F/FX) integrates a two 100Base-X physical layer device (PHY), two complete 10BaseT modules, a two-port 10/100 switch controller and memory into a single chip for both 10Mbps and 100 Mbps Ethernet switch operations. It also supports 100Base-FX operations through external fiber-optic transceivers. The device is capable of operating in either Full-Duplex or Half-Duplex mode in both 10 Mbps and 100 Mbps operations. Operation modes can be selected by hardware configuration pins, software settings of management registers, or determined by the on-chip auto negotiation logic.

The NINJA F/FX (ADM6992F/FX) consists of four major blocks:

- OAM Engine
- 10/100M PHY Block
- Switch Controller Block
- Built-in 6Kx64 SSRAM

3.1 OAM Engine

An OAM packet is used for exchanging the status between two end points of a fiber line. An OAM packet is not in the Ethernet packet format. The NINJA F/FX (ADM6992F/FX) supports OAM packets which follow TS-1000 standard Version 1. The OAM engine module locates between the MAC and fiber PHY. It's in charge of OAM packet transmission and reception. In transmission, it inserts the OAM packet in MII traffic, leaving a 96 bit-time gap between packets. If an OAM packet insertion request occurs when fiber port (port 1) is transmitting a user frame, the OAM engine will wait until the user frame transmission is complete and then insert the OAM packet. When receiving, the OAM engine module can detect the OAM packet from MII traffic. If the received packet is identified as an OAM packet, this packet will not be passed to the MAC.

After power up, the NINJA F/FX (ADM6992F/FX) will start to load the initial settings from the EEPROM and perform LED self test. By default, the NINJA F/FX (ADM6992F/FX) will mask all events which request a state notification indication about 3 to 4 seconds after satisfactory power and fiber port link up. After this, the NINJA F/FX (ADM6992F/FX) will issue a state notification indication frame with its current status. The mask duration can be adjusted from 0 to 8 seconds via the EEPROM register 35_H Bit [10:8].

3.2 10/100M PHY Block

The 100Base-X section of the device implements the following functional blocks:

- 100Base-X physical coding sub-layer (PCS)
- 100Base-X physical medium attachment (PMA)
- 100Base-X physical medium dependent (PMD)

The 10Base-T section of the device implements the following functional blocks:

- 10Base-T physical layer signaling (PLS)
- 10Base-T physical medium attachment (PMA)

The 100Base-X and 10Base-T sections share the following functional blocks:

- Clock synthesizer module
- MII Registers
- IEEE 802.3u auto negotiation

The interfaces used for the communication between the PHY block and switch core is a MII interface.

An Auto MDIX function is supported. This function can be Enabled/Disabled using the hardware pin. A digital approach for the integrated PHY of the NINJA F/FX (ADM6992F/FX) has been adopted.

3.3 Auto Negotiation and Speed Configuration

3.3.1 Auto Negotiation

The Auto Negotiation function provides a mechanism for exchanging configuration information between two ends of a link segment and automatically selecting the highest performance mode of operations supported by both devices. Fast Link Pulse (FLP) Bursts provide the signaling used to communicate auto negotiation abilities between two devices at each end of a link segment. For further details regarding auto negotiation, refer to Clause 28 of the IEEE 802.3u specification. The NINJA F/FX (ADM6992F/FX) supports four different Ethernet protocols, so the inclusion of auto negotiation ensures that the highest performance protocol will be selected based on the ability of the link partner.

The auto negotiation function within the NINJA F/FX (ADM6992F/FX) can be controlled either by internal register access or by the use of configuration pins. If disabled, auto negotiation will not occur until software enables bit 12 in MII Register 0. If auto negotiation is enabled, the negotiation process will commence immediately.

When auto negotiation is enabled, the NINJA F/FX (ADM6992F/FX) transmits the abilities programmed into the auto negotiation advertisement register at address 04_H via FLP bursts. Any combination of 10 Mbps, 100 Mbps, half duplex, and full duplex modes may be selected. Auto negotiation controls the exchange of configuration information. Upon successfully auto negotiating, the abilities reported by the link partner are stored in the auto negotiation link partner ability register at address 05_H.

The contents of the “auto negotiation link partner ability register” are used to automatically configure the highest performance protocol between the local and far-end nodes. Software can determine which mode has been configured by auto negotiation, by comparing the contents of register 04_H and 05_H and then selecting the technology whose bit is set in both registers of highest priority relative to the following list:

1. 100Base-TX full duplex (highest priority)
2. 100Base-TX half duplex
3. 10Base-T full duplex
4. 10Base-T half duplex (lowest priority)

The basic mode control register at address 0_H controls the enabling, disabling and restarting of the auto negotiation function. When auto negotiation is disabled, the speed selection bit (bit 13) controls switching between 10 Mbps or 100 Mbps operation, while the duplex mode bit (bit 8) controls switching between full duplex operation and half duplex operation. The speed selection and duplex mode bits have no effect on the mode of operations when the auto negotiation enable bit (bit 12) is set.

The basic mode status register at address 1_H indicates the set of available abilities for technology types (bit 15 to bit 11), auto negotiation ability (bit 3), and extended register capability (bit 0). These bits are hardwired to indicate the full functionality of the NINJA F/FX (ADM6992F/FX). The BMSR also provides status on:

- Whether auto negotiation is complete (bit 5)
- Whether the Link Partner is advertising that a remote fault has occurred (bit 4)
- Whether a valid link has been established (bit 2)

The auto negotiation advertisement register at address 4_H indicates the auto negotiation abilities to be advertised by the NINJA F/FX (ADM6992F/FX). All available abilities are transmitted by default, but writing to this register or configuring external pins can suppress any ability.

The auto negotiation link partner ability register at address 05_H indicates the abilities of the Link Partner as indicated by auto negotiation communication. The contents of this register are considered valid when the auto negotiation complete bit (bit 5, register address 1_H) is set.

3.3.2 Speed Configuration

The twelve sets of four pins listed in [Table 10](#) configure the speed capability of each channel of the NINJA F/FX (ADM6992F/FX). The logic states of these pins are latched into the advertisement register (register address 4_H)

Function Description

for auto negotiation purpose. These pins are also used for evaluating the default value in the base mode control register (register 0_H) according to [Table 10](#).

In order to make these pins with the same Read/Write priority as software, they should be programmed to 11111111_B in case a user wishes to update the advertisement register through software.

Table 10 Speed Configuration

Advertisement all capability	Advertisement single capability	Parallel detect follow IEEE std.	Auto Negotiation (Pin & EEPROM)	Speed (Pin & EEPROM)	Duplex (Pin & EEPROM)	Auto Negotiation	Advertisement Capability				Parallel Detect Capability			
							100F	100H	10F	10H	100F	100H	10F	10H
1	0	0	1	X	X	1	1	1	1	1	1	0	1	0
1	0	1	1	X	X	1	1	1	1	1	0	1	0	1
1	1	0	1	X	X	1	1	0	0	0	1	0	0	0
1	1	1	1	X	X	1	1	0	0	0	0	1	0	0
0	0	0	1	1	1	1	1	1	1	1	1	0	1	0
0	0	1	1	1	1	1	1	1	1	1	0	1	0	1
0	1	0	1	1	1	1	1	0	0	0	1	0	0	0
0	1	1	1	1	1	1	1	0	0	0	0	1	0	0
0	0	X	1	1	0	1	0	1	0	1	0	1	0	1
0	1	X	1	1	0	1	0	1	0	0	0	1	0	0
0	0	0	1	0	1	1	0	0	1	1	0	0	1	0
0	0	1	1	0	1	1	0	0	1	1	0	0	0	1
0	1	0	1	0	1	1	0	0	1	0	0	0	1	0
0	1	1	1	0	1	1	0	0	1	0	0	0	0	1
0	X	X	1	0	0	1	0	0	0	1	0	0	0	1
X	X	X	0	1	1	0	1	—	—	—	—	—	—	—
X	X	X	0	1	0	0	—	1	—	—	—	—	—	—
X	X	X	0	0	1	0	—	—	1	—	—	—	—	—
X	X	X	0	0	0	0	—	—	—	1	—	—	—	—

3.4 Switch Functional Description

The NINJA F/FX (ADM6992F/FX) supports three types of data forwarding mode, store & forward mode, modified and MII cut-through.

3.4.1 Store & Forward Mode

The NINJA F/FX (ADM6992F/FX) allows switching between different speed media (e.g. 10BaseX and 100BaseX) in store & forward mode. The entire received frame will be stored into its packet buffer. The NINJA F/FX (ADM6992F/FX) checks the length and frame check sequence (FCS) of the received frame to prevent the forwarding of corrupted packets before forwarding to the destination port. A MAC address filtering process can be enabled to filter local traffic to improve overall network performance. The maximum packet length is up to 9216 bytes in this mode. The maximum packet length is defined in Bit [13:0] of EEPROM register 03_H.

3.4.2 Modified Cut-through Mode

The NINJA F/FX (ADM6992F/FX) begins to forward the received packet when it receives the first 64 bytes of the packet. The latency is about 512 bits time width. The NINJA F/FX (ADM6992F/FX) will not forward fragment packets. The MAC address learning & filtering should be disabled in this mode, because the received packets may be corrupted. The maximum packet length is up to 9216 bytes in this mode. The maximum packet length is defined in Bit [13:0] of EEPROM register 03_H.

3.4.3 MII cut-through Mode

The NINJA F/FX (ADM6992F/FX) begins to forward the received packet at the beginning of the received packet. It provides the minimum latency in this mode. The maximum packet length is 9216 bytes if the clock difference between MII receive clock and MII transmit clock is 200Ppm.

3.5 Basic Operations

3.5.1 MAC Address Learning & Filtering

The NINJA F/FX (ADM6992F/FX) adopts 4-way associative hash architecture to store the MAC address table. It can store up to a maximum 1K of MAC addresses.

In store & forward mode, the NINJA F/FX (ADM6992F/FX) receives incoming packets from one of its ports, searches in the Address Table for the Destination MAC Address and then forwards the packet to the other port, if appropriate. If the destination address is not found in the address table, the NINJA F/FX (ADM6992F/FX) treats the packet as a broadcast packet and forwards the packet to the other ports. If the destination port is the same with the port where the packet received from, the NINJA F/FX (ADM6992F/FX) treats the packet as a local traffic packet and discards it.

3.5.2 Address Learning

The NINJA F/FX (ADM6992F/FX) searches for the Source Address (SA) of an incoming packet in the Address Table and acts as below:

1. The NINJA F/FX (ADM6992F/FX) automatically learns the port number of attached network devices by examining the Source MAC Address of all incoming packets at wire speed
2. If the SA was not found in the Address Table (a new address), the NINJA F/FX (ADM6992F/FX) waits until the end of the packet (non-error packet) and updates the Address Table
3. If the SA was found in the Address Table, then the aging value of each corresponding entry will be reset to 0
4. When the DA is in PAUSE mode, then the learning process will be disabled automatically by the NINJA F/FX (ADM6992F/FX)

3.5.3 Hash Algorithm

The NINJA F/FX (ADM6992F/FX) supports two types of hash algorithms for address learning & filtering. The first is the CRC-CCITT polynomial method. The 48 bits MAC address is reduced to a 16 bits CRC hash value. Bit [7:0] of the CRC are used to index the 1K address table. The CRC-CCITT polynomial is

$$X^{16} + X^{12} + X^5 + 1$$

The second is direct-map method. The 48-bit MAC address is mapped into a 8 bits address space by XOR-method to index the 1K address table.

The hash type can be selected using bit [15] of EEPROM register 03_H.

3.5.4 Address Recognition and Packet Forwarding

The address learning & filtering process forwards the incoming packets between bridged ports according to the Destination Address (DA) as below.

1. If the DA is a UNICAST address and the address was found in the Address Table, the NINJA F/FX (ADM6992F/FX) will check the port number and act as follows:
 - a) If the port number is equal to the port on which the packet was received, the packet is discarded.
 - b) If the port number is different from the port on which the packet was received, the packet is forwarded across the bridge.
2. If the DA is a UNICAST address and the address was not found, the NINJA F/FX (ADM6992F/FX) treats it as a multicast packet and forwards it across the bridge.
3. If the DA is a Multicast address, the packet is forwarded across the bridge.
4. If the DA is PAUSE Command (01-80-C2-00-00-01), then this packet will be dropped by the NINJA F/FX (ADM6992F/FX). The NINJA F/FX (ADM6992F/FX) can issue and learn PAUSE commands.
5. The NINJA F/FX (ADM6992F/FX) will forward by default or filter out the packet with DA of (01-80-C2-00-00-00), discard the packet with DA of (01-80-C2-00-00-01), filter out the packet with DA of (01-80-C2-00-00-02 ~ 01-80-C2-00-00-0F), and forward the packet with DA of (01-80-C2-00-00-10 ~ 01-80-C2-00-00-FF) decided by EEPROM Reg.0x0e.

3.5.5 Address Aging

Address aging is supported for topology changes such as an address moving from one port to the other. When this happens, the NINJA F/FX (ADM6992F/FX) internally has 300 seconds timer, after which the address will be "aged out" (removed) from the address table. Aging function can be enabled/disabled by the user. Normally, disabling the aging function is for security purposes.

3.5.6 Back off Algorithm

The NINJA F/FX (ADM6992F/FX) implements the truncated exponential back off algorithm compliant to the 802.3 CSMA-CD standard. The NINJA F/FX (ADM6992F/FX) will restart the back off algorithm by choosing 0-9 collision counts. The NINJA F/FX (ADM6992F/FX) resets the collision counter after 16 consecutive retransmit trials.

3.5.7 Inter-Packet Gap (IPG)

IPG is the idle time between any two successive packets from the same port. The typical number is 96 bits time. The value is 9.6 μ s for 10Mbps ETHERNET, 960ns for 100Mbps fast ETHERNET, and 96ns for 1000M. The NINJA F/FX (ADM6992F/FX) provides an option of 92 bit-time gaps in the EEPROM to prevent packet loss when Flow Control is turned off and the clock P.P.M. value differs.

3.5.8 Illegal Frames

In store & forward mode, the NINJA F/FX (ADM6992F/FX) will discard all illegal frames such as small packets (less than 64 bytes), oversized packets (greater than the value which is defined in Bit [13:0] of EEPROM register 03_H) and bad CRC. Dribbling packing with good CRC value will accept by NINJA F/FX (ADM6992F/FX).

In modified cut-through mode, the NINJA F/FX (ADM6992F/FX) will forward all received packets except for small packets (less than 64 bytes).

In MII cut-through mode, the NINJA F/FX (ADM6992F/FX) will forward all received packets.

3.5.9 Half Duplex Flow Control

A Back Pressure function is supported for half-duplex operation. When the NINJA F/FX (ADM6992F/FX) cannot allocate a received buffer for an incoming packet (buffer full), the device will transmit a jam pattern on the port, thus forcing a collision. Back Pressure is disabled by DISBP which is set during RESETL assertion. A proprietary

algorithm is implemented inside the NINJA F/FX (ADM6992F/FX) to prevent the back pressure function causing HUB partition under a heavy traffic environment and reduce the packet lost rate to increase the whole system performance.

3.5.10 Full Duplex Flow Control

When a full duplex port runs out of its received buffer space, a PAUSE packet command will be issued by the NINJA F/FX (ADM6992F/FX) to notify the packet sender to pause transmission. This frame based flow control is totally compliant to IEEE 802.3x. The NINJA F/FX (ADM6992F/FX) can issue or receive pause packets.

3.5.11 Bandwidth Control

NINJA F/FX (ADM6992F/FX) supports hardware-based bandwidth control for both ingress and egress traffic. Ingress and egress rates can be limited independently on a per port base. The NINJA F/FX (ADM6992F/FX) uses 8ms as the scale, and the minimum bandwidth control unit is 4 kbit/s so users can configure the rate equal to $K * 4$ kbit/s, $1 \leq K \leq 25000$. The NINJA F/FX (ADM6992F/FX) maintains two counters (input and output) for each port. For example, if users want to limit the rate to 64 kbit/s, they should configure the bandwidth control threshold to 16. For each time unit, the NINJA F/FX (ADM6992F/FX) will add 64 to the counter and decrease the byte length when receiving a packet during this period. When the counter is decreased to zero, we can divide the control behavior into two parts:

1. For the ingress control, the ingress port will not stop receiving packets. If flow control is enabled, Pause packets will be transmitted, if Back Pressure is enabled, Jam packets will be transmitted, and if the above functions are not enabled, the packet will be discarded.
2. For the egress control, the egress port will not transmit any packets. The port receiving packets that are forwarded to the egress port will transmit Pause packets if flow control is enabled, transmit Jam packets if Back Pressure is enabled and will discard packets if all the above functions are not enabled.

3.5.12 Interrupt

With the use of external CPU support, the NINJA F/FX (ADM6992F/FX) can issue an interrupt to the CPU if any event defined in SMI interrupt register 10_H and SMI interrupt mask register 11_H occur.

3.5.13 Auto TP MDIX function

The normal application in which a Switch connects to a NIC card is by a one-to-one TP cable. If the Switch connects to other devices such as another Switch, it can be done by two ways. The first is to use a Cross Over TP cable and the second way is to use an extra RJ45 connector by internally crossing over the TXP/TXN and RXP/RXN signals. By using the second way, customers can use a one-to-one cable to connect two Switch devices. All these efforts add extra costs and are not a good solution. The NINJA F/FX (ADM6992F/FX) provides an Auto MDIX function, which adjusts the TXP/TXN and RXP/RXN automatically on the correct pins. Users can use one-to-one cabling between the NINJA F/FX (ADM6992F/FX) and other devices either switches or NICs.

3.6 Converter Functional Description

3.6.1 OAM Buffer

The embedded OAM buffer can store up to 4 received OAM frames (the 2 oldest received OAM frames and the 2 newest received OAM frames). This OAM buffer can be read through an SMI interface. It can be used to extend the NINJA F/FX (ADM6992F/FX)'s OAM handling capability. Both known and unknown OAM frames can be stored into the OAM buffer. Users can set Bit [12:11] to 1 to prevent the NINJA F/FX (ADM6992F/FX) store unknown or known frames into the OAM buffer.

3.6.2 OAM frame transmit

The NINJA F/FX (ADM6992F/FX) transmits OAM frames when the following condition occurs.

1. State Notification required in TS-1000.
 - a) Power failure
 - b) Receive light error
 - c) Normal receive light
 - d) MC failure
 - e) MC failure recover
 - f) Terminal side link disconnection
 - g) Terminal side link establishment
 - h) Time-out of timer 2(T2 timer)
 - i) Terminal side link setting state change (option B)
2. Power failure recover
3. OAM request frame is received
 - a) Loop back test start request
 - b) Loop back test end request
 - c) State notification request
4. OAM frame transmitted request via Bit [9] of SMI OAM control register 14_H.

The content of the transmitted frame requested via the SMI interface is defined in the SMI transmit OAM register 17_H, 18_H and 19_H. Besides the PREAMBLE field, users can assign each bit in the C field, S field, M field, and CRC field. The NINJA F/FX (ADM6992F/FX) will discard the M field and pad pre-defined M field defined in EEPROM register 36_H, 37_H and 38_H if Bit [2] of SMI OAM control register 14_H is 0. The NINJA F/FX (ADM6992F/FX) will discard the CRC field and pad the CRC calculating it by using its internal CRC engine based on the content of the transmitted OAM frame if Bit [1] of the SMI OAM control register 14_H is 0.

After power is up and port 1 links up, the NINJA F/FX (ADM6992F/FX) starts a 3 seconds timer. The NINJA F/FX (ADM6992F/FX) will mask all state notification requests until the timer expires. A Power-Up state notification frame will be transmitted after the timer expires.

If power failure is detected, the NINJA F/FX (ADM6992F/FX) will transmit a power failure state notification frame and mask all state notification requests. If the power failure recovers and port 1 links up, the NINJA F/FX (ADM6992F/FX) will start a 3 seconds timer. The NINJA F/FX (ADM6992F/FX) will mask all state notification requests until the timer expires. A power-up state notification frame will be transmitted after the timer expires.

3.6.3 Power failure detection

For a 128 pin package, the NINJA F/FX (ADM6992F/FX) supports 2 schemes to detect the power status. In the first scheme the NINJA F/FX (ADM6992F/FX) detects the voltage of pin A_PD_DETECT. If the voltage of pin A_PD_DETECT is greater than 1.2 V, the NINJA F/FX (ADM6992F/FX) will enter a good power state. If the voltage of pin A_PD_DETECT is smaller than 1.2 V, the NINJA F/FX (ADM6992F/FX) will enter a power failure state. The second scheme involves the NINJA F/FX (ADM6992F/FX) detecting the logical level of pin D_PD_DETECT. If the logical level of pin D_PD_DETECT is 0, the NINJA F/FX (ADM6992F/FX) will enter a good power state. If the logical level of pin D_PD_DETECT is 1, the NINJA F/FX (ADM6992F/FX) will enter a power failure state. For a 64-pin package, only A_PD_DETECT can be used to detect the power status. There is a 1 second filter applied to prevent the bouncing effect of the A_PD_DETECT and D_PD_DETECT.

3.6.4 Automatic User Frame Generation

Users can set Bit [10] of the SMI OAM control register to 1 to request the NINJA F/FX (ADM6992F/FX) transmit a pre-defined Ethernet frame from port 1. The NINJA F/FX (ADM6992F/FX) will transmit a broadcast frame with the packet length and SA defined in the SMI source address register 15_H and 16_H. The background of the frame is "increase byte". The NINJA F/FX (ADM6992F/FX) will calculate and pad the CRC to the frame automatically. The CRC will be stored into its internal register for comparably purposes.

3.6.5 Automatic User Frame Comparison

The NINJA F/FX (ADM6992F/FX) automatically compares the CRC registered in section 2.5.3 with port 1 received Ethernet frames if Bit [8:5] of SMI OAM control register 14_H is not 0000. The NINJA F/FX (ADM6992F/FX) will compare every received Ethernet frame to find the first CRC matched frame during the period of time defined in Bit [8:5] of SMI OAM control register 14_H. The NINJA F/FX (ADM6992F/FX) will generate an interrupt request if the frame is found or the timer expires.

3.6.6 Fault Propagation

The NINJA F/FX (ADM6992F/FX) Media Converter incorporates a Fault Propagation feature, which allows indirect sensing of a Fiber Link Loss via the 10/100Base-TX UTP connection. Whenever the NINJA F/FX (ADM6992F/FX) Media Converter detects a Link Loss condition on the Receive fiber (Fiber LNK OFF), it disables its UTP link pulse so that a Link Loss condition will be sensed on the UTP port to which the NINJA F/FX (ADM6992F/FX) Media Converter is connected. This link loss can then be sensed and reported by a Network Management agent in the remote UTP port's host equipment. This feature will affect the NINJA F/FX (ADM6992F/FX) UTP LNK LED.

The NINJA F/FX (ADM6992F/FX) Media Converter also incorporates a Far End Fault feature, which allows the stations on both ends of a pair of fibers to be informed when there is a problem with one of the fibers. Without Far End Fault, it is impossible for a fiber interface to detect a problem that affects only its Transmit fiber.

When Far End Fault is supported and enabled, a loss of received signal (link) will cause the transmitter to generate a Far End Fault pattern in order to inform the device at the far end of the fiber pair that a fault has occurred. Unless Fiber Link Loss occurs or if the UTP port link fails, the NINJA F/FX (ADM6992F/FX) Media Converter will also generate a Far End Fault pattern in order to inform the device at the far end of the fiber pair that a fault has occurred.

3.6.7 Remote Control

The remote control function can be enabled by setting Bit [5] of EEPROM register 35_H to 1. When setting up the UTP link of the CPE from CO, the OAM is sent out from the CO to CPE. The CPE which receives the OAM changes the UTP setup according to the OAM, and sends out an OAM which assigns the setting value to CO. A setup performed in OAM is confirmed until it receives the next OAM.

When this function is enabled, all setup of DIPSW becomes invalid and follows only a remote setup from CO. Not the setting value of DIPSW but the remote setting value from CO is assigned also to the UTP link setting value field (S7-S10) of the state notice OAM.

Details of OAM delivered and carried out between CO and CPE are shown in [Table 11](#)

Table 11 OAM Delivery Between CO and CPE

		CO		CPE	
		Remote Control Start	Remote Control Stop	Remote Control Start	Remote Control Stop
C1	Direction	1: Down side	1: Down side	0: Down side	0: Down side
C2-C3	Order	10: Request	10: Request	11: Response	11: Response
C8-C15	Control signal	EEPROM register 36 _H Bit [7:0]	EEPROM register 36 _H Bit [15:8]	EEPROM register 36 _H Bit [7:0]	EEPROM register 36 _H Bit [15:8]
S7-S8	Speed	00: 10Mbit/s 01: 100Mbit/s	Don't care	Real status after remote control	Current status of CPE (no remote control)

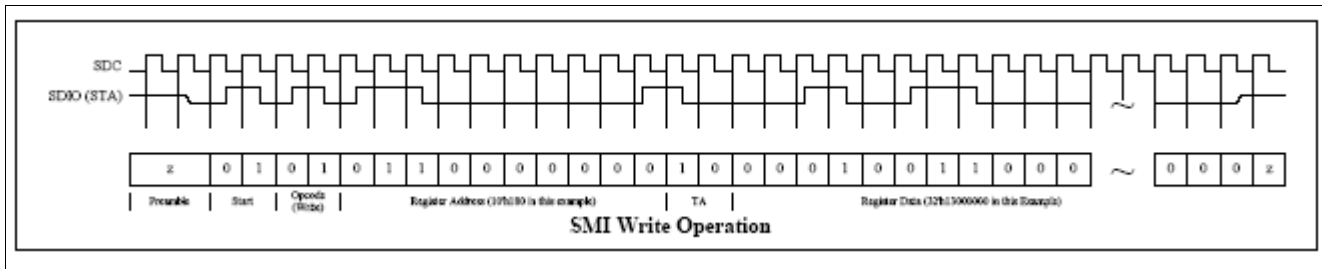

Figure 4 SMI Write Operation

3.7.1 Preamble Suppression

The SMI of NINJA F/FX (ADM6992F/FX) supports a preamble suppression mode. If the station management entity (i.e. MAC or other management controller) determines that all devices which are connected to the same SDC/SDIO in the system support preamble suppression, then the station management entity needs not to generate preamble for each management transaction. The NINJA F/FX (ADM6992F/FX) requires a single initialization sequence of 35 bits of preamble following power-up/hardware reset. This requirement is generally met by pulling-up the resistor of SDIO. While the NINJA F/FX (ADM6992F/FX) will respond to management accesses without preamble, a minimum of one idle bit between management transactions is required.

When NINJA F/FX (ADM6992F/FX) detects that there is address match, then it will enable Read/Write capability for external access. When an address is mismatched, then NINJA F/FX (ADM6992F/FX) will tri-state the SDIO pin.

3.7.2 Read EEPROM Register via SMI Register

The following 2 steps are for reading the data of EEPROM Register via SMI Interface.

Write the address of the desired EEPROM Register and READ command to SMI Register 013_H

EX. <35"1"s><01><01><00000><10011><10><000 0000000 000001 0000000000000000>

CMD ADDRESS DATA

Read NINJA F/FX (ADM6992F/FX) Internal EEPROM mapping Reg.1_H. Read SMI Register 013_H. The data of desired EEPROM Register will be in bit [15:0].

EX. <35"1"s><01><10><00000><10011><z0><000 0000000 000000 0001000001001111>

CMD ADDRESS DATA

Get NINJA F/FX (ADM6992F/FX) Internal EEPROM mapping Reg.1_H. value 104f.

3.7.3 Write EEPROM Register via SMI Register

To write data into desired EEPROM Register, write the address of the EEPROM Register.

EX. <35"1"s><01><01><00000><00100><10><001 0000000 000001 0001000001000000>

CMD ADDRESS DATA

Write NINJA F/FX (ADM6992F/FX) Internal EEPROM mapping Reg.1_H. with value 820f.

3.8 Reset Operation

The NINJA F/FX (ADM6992F/FX) can be reset either by hardware or software. A hardware reset is accomplished by applying a negative pulse, with duration of at least 100 ms to the RC pin of the NINJA F/FX (ADM6992F/FX) during normal operation to guarantee internal SSRAM is reset properly.

Hardware reset operation samples the pins and initializes all registers to their default values. This process includes re-evaluation of all hardware configurable registers. A hardware reset affects all embedded PHYs in the device.

Software reset can reset all embedded PHY and it does not latch the external pins nor reset the registers to their respective default value. This can be achieved by writing FF to EEPROM Reg.3F_H.

Logic levels on several I/O pins are detected during a hardware reset to determine the initial functionality of NINJA F/FX (ADM6992F/FX). Some of these pins are used as output ports after reset operation.

Care must be taken to ensure that the configuration setup will not interfere with normal operations. Dedicated configuration pins can be tied to VCC or Ground directly. Configuration pins multiplexed with logic level output functions should be either weakly pulled up or weakly pulled down through external resistors.

3.8.1 Write EEPROM Register via EEPROM Interface

To write data into desired EEPROM Register via EEPROM interface:

If external EEPROM 93C46 or 93C66 exists, any WRITE programming instructions after EWEN instruction be executed can be updated effectively on EEPROM content and NINJA F/FX (ADM6992F/FX) internal mapping register on the same time.

If no external EEPROM exists, EECS/EECK/EEDI must be kept tri-state at least 100ms after hardware reset. Any WRITE programming instructions after EWEN instruction be executed can be updated effectively on NINJA F/FX (ADM6992F/FX) internal mapping register. Please notice that NINJA F/FX (ADM6992F/FX) can only identify 93C66-programming instructions if no external EEPROM.

4 Registers Description

This chapter describes descriptions of EEPROM Registers and Serial Management Registers.

4.1 EEPROM Registers

Table 13 EEPROM Register Map

Register	Bit 15-8	Bit 7-0	Default Value
00 _H	Signature		4154 _H
01 _H	Port 0 Configuration		104F _H
02 _H	Port 1 Configuration		104F _H
03 _H	Miscellaneous Configuration 0		0600 _H
04 _H	Miscellaneous Configuration 1		0000
05 _H	Miscellaneous Configuration 2		0014 _H
06 _H	Buffer Management Configuration 0		0198 _H
07 _H	Buffer Management Configuration 1		0258 _H
08 _H	Buffer Management Configuration 2		0008 _H
09 _H	Bandwidth Control Configuration 0		0000 _H
0A _H	Bandwidth Control Configuration 1		0000 _H
0B _H	Bandwidth Control Configuration 2		0000 _H
0C _H	Bandwidth Control Configuration 3		0000 _H
0D _H	PHY Miscellaneous Configuration		1A74 _H
0E _H	Reserved MAC Address Filtering Configuration		0014
0F _H	Filter Control Register 1	Filter Control Register 0	0000 _H
10 _H	Filter Control Register 3	Filter Control Register 2	0000 _H
11 _H	Filter Control Register 5	Filter Control Register 4	0000 _H
12 _H	Filter Control Register 7	Filter Control Register 6	0000 _H
13 _H	Filter Control Register 9	Filter Control Register 8	0000 _H
14 _H	Filter Control Register 11	Filter Control Register 10	0000 _H
15 _H	Filter Control Register 13	Filter Control Register 12	0000 _H
16 _H	Filter Control Register 15	Filter Control Register 14	0000 _H
17 _H	Filter Type Register 0		0000 _H
18 _H	Filter Type Register 1		0000 _H
19 _H	Filter Register 0		0000 _H
1A _H	Filter Register 1		0000 _H
1B _H	Filter Register 2		0000 _H
1C _H	Filter Register 3		0000 _H
1D _H	Filter Register 4		0000 _H
1E _H	Filter Register 5		0000 _H
1F _H	Filter Register 6		0000 _H
20 _H	Filter Register 7		0000 _H
21 _H	Filter Register 8		0000 _H
22 _H	Filter Register 9		0000 _H

Table 13 EEPROM Register Map (cont'd)

Register	Bit 15-8	Bit 7-0	Default Value
23 _H	Filter Register 10		0000 _H
24 _H	Filter Register 11		0000 _H
25 _H	Filter Register 12		0000 _H
26 _H	Filter Register 13		0000 _H
27 _H	Filter Register 14		0000 _H
28 _H	Filter Register 15		0000 _H
29 _H	PVID and PCID MASK of Port 0		00001
2A _H	PVID and PCID MASK of Port 0		0000 _H
2B _H	PVID and PCID MASK of Port 1		00001
2C _H	PVID and PCID MASK of Port 1		D000 _H
2D _H	Tag Rule 0		F000 _H
2E _H	Tag Rule 0		00FF _H
2F _H	Tag Rule 1		F000 _H
30 _H	Tag Rule 1		00FF _H
31 _H	Tag Rule 2		F000 _H
32 _H	Tag Rule 2		00FF _H
33 _H	Tag Rule 3		F000 _H
34 _H	Tag Rule 2		00FF _H
35 _H	OAM Configuration Register 1		0380 _H
36 _H	OAM Configuration Register 2		FEFF _H
37 _H	Vender Code[15:0]		0000 _H
38 _H	Model Number[7:0]	Vender Code[23:16]	0000 _H
39 _H	Model Number[23:8]		0000 _H
3A _H	Forwarding Configuration 1		6000 _H
3B _H	Forwarding Configuration 2		0000 _H
3C _H	Default Value Control Register		0000 _H

4.2 EEPROM Register Descriptions

Table 14 Registers Address Space

Module	Base Address	End Address	Note
EEPROM	00 _H	3C _H	

Table 15 Registers Overview

Register Short Name	Register Long Name	Offset Address	Page Number
SR	Signature Register	00 _H	34
PCR_0	Port Configuration Register 0	01 _H	35
PCR_1	Port Configuration Register 1	02 _H	36
MC_0	Miscellaneous Configuration 0	03 _H	37
MCR_1	Miscellaneous Configuration Register 1	04 _H	37
MCR_2	Miscellaneous Configuration Register 2	05 _H	39
BMC_0	Buffer Management Configuration 0	06 _H	40
BMC_1	Buffer Management Configuration 1	07 _H	40
BMC_2	Buffer Management Configuration 2	08 _H	41
IBW_CCR_0	Ingress Bandwidth Control Configuration 0	09 _H	41
EBW_CCR_1	Egress Bandwidth Control Configuration 1	0A _H	42
IBW_CCR_2	Ingress Bandwidth Control Configuration 2	0B _H	42
EBW_CCR_3	Egress Bandwidth Control Configuration 3	0C _H	42
PHY_MC	PHY Miscellaneous Configuration	0D _H	43
MAC_AFC	MAC Address Filtering Configuration	0E _H	44
PCFC_1_0	Packet Filter Control Register 1 and 0	0F _H	45
PCFC_3_2	Packet Filter Control Registers 3 and 2	10 _H	45
PCFC_5_4	Packet Filter Control Registers 5 and 4	11 _H	45
PCFC_7_6	Packet Filter Control Registers 7 and 6	12 _H	45
PCFC_9_8	Packet Filter Control Registers 9 and 8	13 _H	45
PCFC_11_10	Packet Filter Control Registers 11 and 10	14 _H	45
PCFC_13_12	Packet Filter Control Registers 13 and 12	15 _H	45
PCFC_15_14	Packet Filter Control Registers 15 and 14	16 _H	45
TFTR_0	Filter Type Register 0	17 _H	46
TFTR_1	Filter Type Register 1	18 _H	46
FR_0	Filter Register 0	19 _H	47
FR_1	Filter Register 1	1A _H	47
FR_2	Filter Register 2	1B _H	47
FR_3	Filter Register 3	1C _H	47
FR_4	Filter Register 4	1D _H	47
FR_5	Filter Register 5	1E _H	47
FR_6	Filter Register 6	1F _H	47
FR_7	Filter Register 7	20 _H	47
FR_8	Filter Register 8	21 _H	47

Table 15 Registers Overview (cont'd)

Register Short Name	Register Long Name	Offset Address	Page Number
FR_9	Filter Register 9	22 _H	47
FR_10	Filter Register 10	23 _H	47
FR_11	Filter Register 11	24 _H	47
FR_12	Filter Register 12	25 _H	47
FR_13	Filter Register 13	26 _H	47
FR_14	Filter Register 14	27 _H	47
FR_15	Filter Register 15	28 _H	47
PB_ID_0_0	Port Base VLAN ID and Mask 0 of Port 0	29 _H	48
PB_ID_1_0	Port Base VLAN ID and Mask 1 of Port 0	2A _H	48
PB_ID_0_1	Port Base VLAN ID and Mask 0 of Port 1	2B _H	49
PB_ID_1_1	Port Base VLAN ID and Mask 1 of Port 1	2C _H	49
TPR_0_0	Tag Port Rule 0 Register 0	2D _H	50
TPR_1_0	Tag Port Rule 1 Register 0	2E _H	50
TPR_0_1	Tag Port Rule 0 Register 1	2F _H	50
TPR_1_1	Tag Port Rule 1 Register 1	30 _H	51
TPR_0_2	Tag Port Rule 0 Register 2	31 _H	50
TPR_1_2	Tag Port Rule 1 Register 2	32 _H	51
TPR_0_3	Tag Port Rule 0 Register 3	33 _H	50
TPR_1x	Tag Port Rule 1 x	34 _H	51
OAM_C_1	OAM Configuration Register 1	35 _H	51
OAM_CR_2	OAM Configuration Register 2	36 _H	53
MCR_3	Miscellaneous Configuration Register 3	37 _H	53
MCR_4	Miscellaneous Configuration 4	38 _H	54
MCR_5	Miscellaneous Configuration Register 5	39 _H	54
FC_1	Forwarding Configuration 1	3A _H	55
FC_2	Forwarding Configuration 2	3B _H	55
DV_CR	Default Value Control Register	3C _H	56

The register is addressed wordwise.

Table 16 Register Access Types

Mode	Symbol	Description HW	Description SW
read/write	nw	Register is used as input for the HW	Register is readable and writable by SW
read	r	Register is written by HW (register between input and output -> one cycle delay)	Value written by software is ignored by hardware; that is, software may write any value to this field without affecting hardware behavior (= Target for development.)
Read only	ro	Register is set by HW (register between input and output -> one cycle delay)	SW can only read this register
Read virtual	rv	Physically, there is no new register, the input of the signal is connected directly to the address multiplexer.	SW can only read this register

Registers Description

Table 16 Register Access Types (cont'd)

Mode	Symbol	Description HW	Description SW
Latch high, self clearing	lhsc	Latches high signal at high level, clear on read	SW can read the register
Latch low, self clearing	llsc	Latches high signal at low-level, clear on read	SW can read the register
Latch high, mask clearing	lhmk	Latches high signal at high level, register cleared with written mask	SW can read the register, with write mask the register can be cleared (1 clears)
Latch low, mask clearing	llmk	Latches high signal at low-level, register cleared on read	SW can read the register, with write mask the register can be cleared (1 clears)
Interrupt high, self clearing	ihsc	Differentiates the input signal (low->high) register cleared on read	SW can read the register
Interrupt low, self clearing	ilsc	Differentiates the input signal (high->low) register cleared on read	SW can read the register
Interrupt high, mask clearing	ihmk	Differentiates the input signal (high->low) register cleared with written mask	SW can read the register, with write mask the register can be cleared
Interrupt low, mask clearing	ilmk	Differentiates the input signal (low->high) register cleared with written mask	SW can read the register, with write mask the register can be cleared
Interrupt enable register	ien	Enables the interrupt source for interrupt generation	SW can read and write this register
latch_on_reset	lor	rw register, value is latched after first clock cycle after reset	Register is readable and writable by SW
Read/write self clearing	rwsc	Register is used as input for the hw, the register will be cleared due to a HW mechanism.	Writing to the register generates a strobe signal for the HW (1 pdi clock cycle) Register is readable and writable by SW.

Table 17 Registers Clock DomainsRegisters Clock Domains

Clock Short Name	Description

4.2.1 EEPROM Register Format

Signature Register

SR	Offset	Reset Value
Signature Register	00_H	4154_H

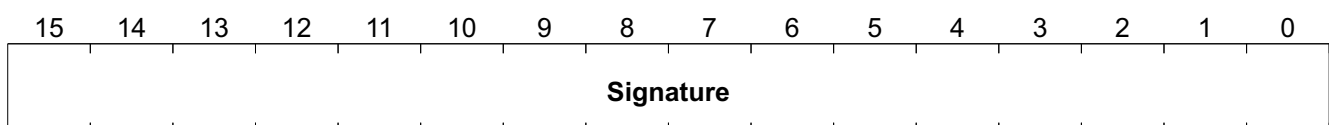

ro

Field	Bits	Type	Description
Signature	15:0	ro	Signature 4154 _H SIG , Default (AT)

Port Configuration Register 0

PCR_0 **Offset**
01_H **Reset Value**
104F_H
Port Configuration Register 0

15	14	13	12	11	10	9	8	7	6	5	4	3	2	1	0
LBC	PAC	RPT	OPTC			MAC			ANPD	AN	ANA	DX	SP	ANE	FC
rw	rw	rw	rw			rw			rw	rw	rw	rw	rw	rw	rw

Field	Bits	Type	Description
LBC	15	rw	Loop-back Control 0 _B N , Normal Operation (Default) 1 _B LP , Local Loop-back for Port1/Port0
PAC	14	rw	Packet Authorization Control 0 _B ALL , All packet (Default) 1 _B PPP , PPPOE only
RPT	13	rw	Receive Packet TAG Recognition Control 0 _B REC , Recognize VLAN TAG automatically (Default) 1 _B DIS , Disable
OPTC	12	rw	Output Packet Tagging Control 0 _B TAG , TAG/UNTAG packets if needed 1 _B BP , Bypass TX packets same as RX (Default)
MAC	11:7	rw	MAC Learning Table Entry Limitation 0 _B DIS , Disable Total MAC Limitation (Default) 1 _B MAX , Maximum allowable total MAC
ANPD	6	rw	Auto-Negotiation Parallel Detect Follow IEEE802.3 0 _B B , Both 1 _B H , Half only (Default)
AN	5	rw	Auto-Negotiation Advertise Single Capability 0 _B E , Expand (Default) 1 _B S , Single
ANA	4	rw	Auto-Negotiation Advertisement 0 _B FS , Follow speed and duplex setting to negotiate with link partner. (Default) 1 _B 4W , Always 4 way Auto-negotiation
DX	3	rw	Duplex 0 _B HD , Half Duplex 1 _B FD , Full Duplex (Default)

Registers Description

Field	Bits	Type	Description
SP	2	rw	Speed 0 _B 10M , 10M 1 _B 100M , 100M (Default)
ANE	1	rw	Auto negotiation Enable 0 _B D , Disable Auto-negotiation 1 _B E , Enable Auto-negotiation. (Default)
FC	0	rw	802.3x Flow Control Command Ability 0 _B D , Disable 802.3x Flow control command ability 1 _B E , Enable 802.3x Flow control command ability (Default)

Port Configuration Register 1

PCR_1 **Offset**
Port Configuration Register 1 **02_H** **Reset Value**
104F_H

15	14	13	12	11	10	9	8	7	6	5	4	3	2	1	0
LBC	PAC	RPT	OPTC	MAC			ANPD	AN	ANA	DX	SP	ANE	FC		
rw	rw	rw	rw	rw			rw	rw	rw	rw	rw	rw	rw	rw	

Field	Bits	Type	Description
LBC	15	rw	Loop-back Control 0 _B N , Normal Operation (Default) 1 _B LP , Local Loop-back for Port1/Port0
PAC	14	rw	Packet Authorization Control 0 _B ALL , All packet (Default) 1 _B PPP , PPPOE only
RPT	13	rw	Receive Packet TAG Recognition Control 0 _B REC , Recognize VLAN TAG automatically (Default) 1 _B DIS , Disable
OPTC	12	rw	Output Packet Tagging Control 0 _B TAG , TAG/UNTAG packets if needed 1 _B BP , Bypass TX packets same as RX (Default)
MAC	11:7	rw	MAC Learning Table Entry Limitation 0 _B DIS , Disable Total MAC Limitation (Default) 1 _B MAX , Maximum allowable total MAC
ANPD	6	rw	Auto-Negotiation Parallel Detect Follow IEEE802.3 0 _B B , Both 1 _B H , Half only (Default)
AN	5	rw	Auto-Negotiation Advertise Single Capability 0 _B E , Expand (Default) 1 _B S , Single

Registers Description

Field	Bits	Type	Description
ANA	4	rw	Auto-Negotiation Advertisement 0_B FS , Follow speed and duplex setting to negotiate with link partner. (Default) 1_B 4W , Always 4 way Auto-negotiation
DX	3	rw	Duplex 0_B HD , Half Duplex 1_B FD , Full Duplex (Default)
SP	2	rw	Speed 0_B 10M , 10M 1_B 100M , 100M (Default)
ANE	1	rw	Auto negotiation Enable 0_B D , Disable Auto-negotiation 1_B E , Enable Auto-negotiation. (Default)
FC	0	rw	802.3x Flow Control Command Ability 0_B D , Disable 802.3x Flow control command ability 1_B E , Enable 802.3x Flow control command ability (Default)

Miscellaneous Configuration 0

MC_0 Offset Reset Value
 Miscellaneous Configuration 0 03_H 0600_H

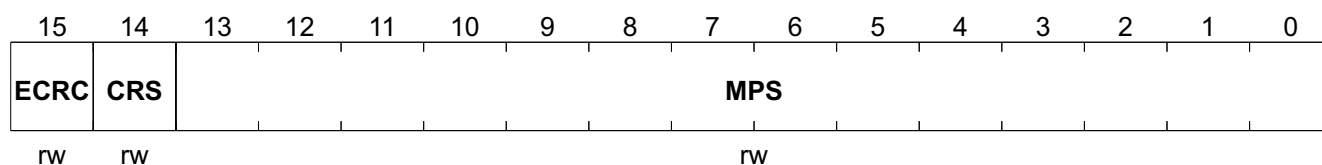

Field	Bits	Type	Description
ECRC	15	rw	Enable CRC Check 0_B E , Enable (Default) 1_B D , Disable
CRS	14	rw	CRS (carrier sense) check disable Checking of the length of CRS 0_B ED , Enable (Default) 1_B DD , Disable
MPS	13:0	rw	Maximum Packet Size Maximum allowable frame size in bytes 9216_D MAX , Max. bytes number 1536_D DEF , Default value

Miscellaneous Configuration Register 1

Registers Description

MCR_1 **Offset** **Reset Value**
Miscellaneous Configuration Register 1 **04_H** **0000_H**

	15	14	13	12	11	10	9	8	7	6	5	4	3	2	1	0
	LED-ST	LED-ON	MAC	PFRC	Res	VLAN	EFM-P0	PL	DBO	DP	AD			Res		
	rw	rw	rw	rw	ro	rw	rw	rw	rw	rw	rw			ro		

Field	Bits	Type	Description
LED-ST	15	rw	LED Status Definition when UTP link down 0 _B TBD , always put off LEDs of UTP port when UTP link down (Default) 1 _B TBD , LEDs of UTP port show DIPSW setting when auto-negotiation disable and link down
LED-ON	14	rw	Turn on all LED at the same time during LED self test 0 _B TBD , Disable (Default) 1 _B TBD , Enable
MAC	13	rw	MAC address table hashing algorithm Control 0 _B DM , MAC address lookup table use direct mode to generate hash key (Default) 1 _B CRC , MAC address lookup table use CRC to generate hash key
PFRC	12	rw	Pause Frame Recognition Control when auto-negotiation disable 0 _B STOP , Stop transmitting frame if PAUSE frame received. (Default) 1 _B NOS , Don't stop transmitting frame if PAUSE frame received when flow control capability is disabled.
Res	11	ro	Reserved 0 _B DEF , Default
VLAN	10	rw	Replace VLAN ID 0 and 1 by PVID 0 _B D , Disable (Default) 1 _B R , Replace
EFM-P0	9	rw	Emulated Force Mode for Port0 0 _B D , Disable (Default) 1 _B TBD ,
PL	8	rw	Preamble Leveling 0 _B 7B , 7 bytes (Default) 1 _B 6B , 6 bytes
DBO	7	rw	Disable Back-Off 0 _B E , Enable (Default) 1 _B D , Disable
DP	6	rw	Discard Packet after 16th Collision 0 _B E , Disable (Default) 1 _B D , Enable

Registers Description

Field	Bits	Type	Description
AD	5	rw	Aging Disable 0 _B E, Enable aging (Default) 1 _B D, Disable aging
Res	4:0	ro	Reserved

Miscellaneous Configuration Register2

MCR_2	Offset	Reset Value
Miscellaneous Configuration Register 2	05 _H	0014 _H

15	14	13	12	11	10	9	8	7	6	5	4	3	2	1	0
PD	AG	LPTDIS	P0_MDI	XOVEN	FCDIS	RECHALF	REC10	ANDIS	Res	FTPR	FPC	Cut	UTP_LED	UTP_Link	
rw	rw	rw	rw	rw	rw	rw	rw	rw	ro	rw	rw	rw	rw	rw	rw

Field	Bits	Type	Description
PD	15	rw	Polarity definition Change for hardware pin INT_N 0 _B LA, INT_N Low Active (Default) 1 _B HA, INT_N High Active
AG	14	rw	Aging 0 _B N, Normal (Default) 1 _B F, Fast
LPTDIS	13	rw	Polarity definition change for hardware pin LPTDIS 0 _B DIP, Disable Inverse Polarity of LPTDIS (Default) 1 _B IP, Inverse Polarity of LPTDIS
P0_MDI	12	rw	Polarity definition change for hardware pin P0_MDI 0 _B DIP, Disable Inverse Polarity of P0_MDI (Default) 1 _B IP, Inverse Polarity of P0_MDI
XOVEN	11	rw	Polarity definition change for hardware pin XOVEN 0 _B DIP, Disable Inverse Polarity of XOVEN (Default) 1 _B IP, Inverse Polarity of XOVEN
FCDIS	10	rw	Polarity definition change for hardware pin P0_FCDIS and P1_FCDIS 0 _B DIP, Disable Inverse Polarity (Default) 1 _B IP, Inverse Polarity
RECHALF	9	rw	Polarity definition change for hardware pin P0_RECHALF and P1_RECHALF 0 _B DIP, Disable Inverse Polarity (Default) 1 _B IP, Inverse Polarity
REC10	8	rw	Polarity definition change for hardware pin P0_REC10 and P1_REC10 0 _B DIP, Disable Inverse Polarity (Default) 1 _B IP, Inverse Polarity

Registers Description

Field	Bits	Type	Description
ANDIS	7	rw	Polarity definition change for hardware pin P0_ANDIS and P1_ANDIS 0 _B DIP , Disable Inverse Polarity (Default) 1 _B IP , Inverse Polarity
Res	6	ro	Reserved 0 _B DEF , Default
FTPR	5:4	rw	FTPR_MODE 00 _B OAM , OAM 01 _B FEFI , FEFI(Default) 1x _B IDS , Disable
FPC	3	rw	Fault Propagation Control 0 _B EP , Enable Fault Propagation in converter mode (Default) 1 _B DP , Disable Fault Propagation
Cut	2	rw	Cut-Through Forwarding Control in converter mode 0 _B ES , Enable 100M snooping in converter mode 1 _B DS , Disable snooping (Default)
UTP_LED	1	rw	UTP led control during Loop Back Test 0 _B OFF , Put off LEDs of UTP port during loopback test . (Default) 1 _B NOT , Don.t put off LEDs of UTP port during loopback test.
UTP_Link	0	rw	UTP link control during Loop Back Test 0 _B LD , Link Disable during Loop Back Test(Default) 1 _B LE , Link Enable during Loop Back Test

Buffer Management Configuration 0

BMC_0 **Offset**
Buffer Management Configuration 0 **06_H** **Reset Value**
0198_H

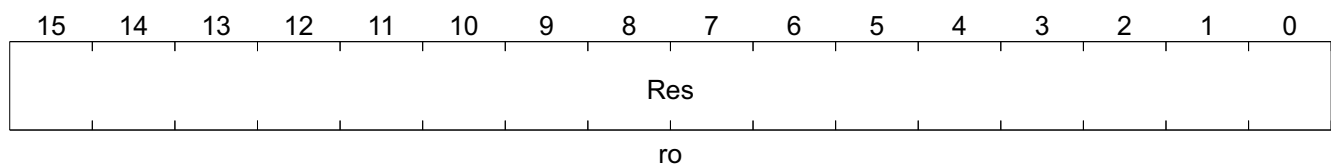

Field	Bits	Type	Description
Res	15:0	ro	Reserved 0198 _H DEF , Default

Buffer Management Configuration 1

BMC_1 **Offset**
Buffer Management Configuration 1 **07_H** **Reset Value**
0258_H

Registers Description

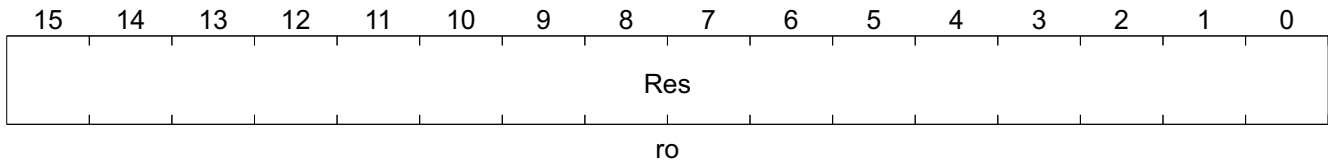

Field	Bits	Type	Description
Res	15:0	ro	Reserved 0258 _H DEF , Default

Buffer Management Configuration 2

BMC_2 **Offset**
Buffer Management Configuration 2 **08_H** **Reset Value**
0008_H

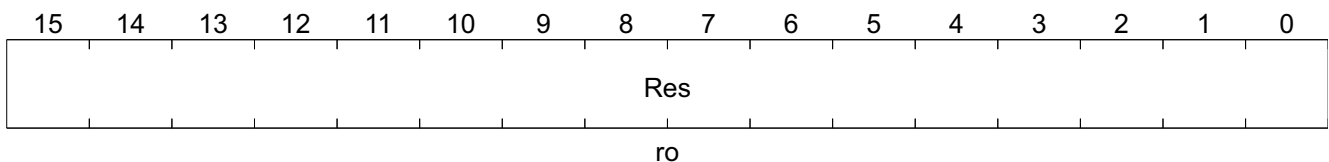

Field	Bits	Type	Description
Res	15:0	ro	Reserved 0008 _H DEF , Default

Ingress Bandwidth Control Configuration 0

IBW_CCR_0 **Offset**
Ingress Bandwidth Control Configuration 0 **09_H** **Reset Value**
0000_H

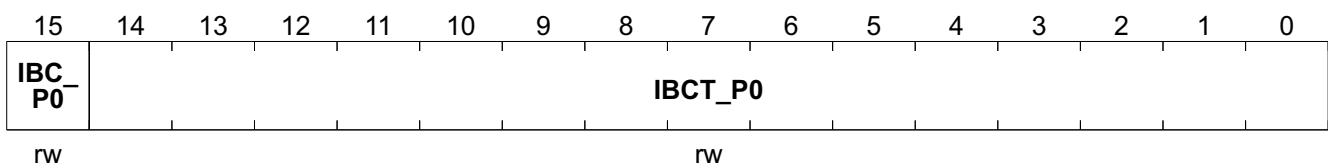

Field	Bits	Type	Description
IBC_P0	15	rw	Port 0 Ingress Bandwidth Control 0 _B D , Disable (Default) 1 _B E , Enable
IBCT_P0	14:0	rw	Port0 Ingress Bandwidth Control Threshold Step size: 4 Kbytes 0000 _H DEF , Default

Registers Description

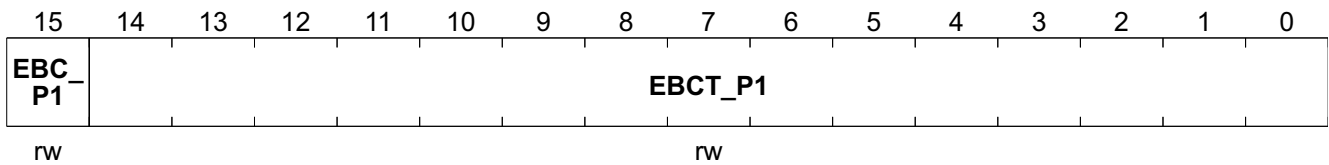

Field	Bits	Type	Description
EBC_P1	15	rw	Port 1 Egress Bandwidth Control 0 _B D , Disable (Default) 1 _B E , Enable
EBCT_P1	14:0	rw	Port 1 Egress Bandwidth Control Threshold Step size: 4 Kbytes 0000 _H Z , Default

PHY Miscellaneous Configuration

PHY_MC	Offset	Reset Value
PHY Miscellaneous Configuration	0D_H	1A74_H

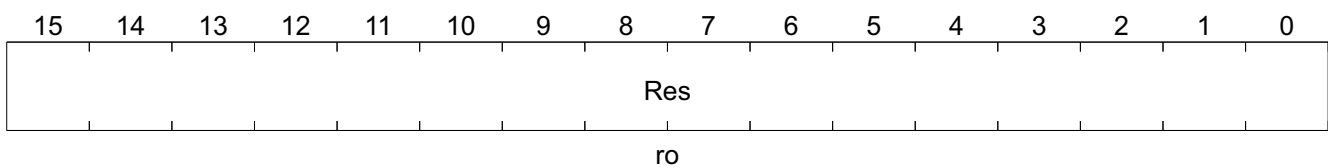

Field	Bits	Type	Description
Res	15:0	ro	Reserved 1A74 _H CONF , Default

Reserved MAC Address Filtering Configuration

MAC_AFC **Offset**
MAC Address Filtering Configuration **0E_H** **Reset Value**
0014_H

15	14	13	12	11	10	9	8	7	6	5	4	3	2	1	0
MFM		TUFM		Res	CRC	Res	PFM_10		PFM_02		PFM_01		PFM_00		
rw		rw		ro	ro	ro	rw		ro		rw		rw		

Field	Bits	Type	Description
MFM	15:14	rw	Match Frame Mode 00 _B SAM , CRC is correct and the same with CRC of last requested transmitted user frame (Default) 01 _B COR , CRC is correct 10 _B DIF , CRC is incorrect or different with CRC of last requested transmitted user frame 11 _B INC , CRC is incorrect
TUFM	13:12	rw	Transmit user frame mode 00 _B SF , Single frame (Default) 01 _B CMF , Continuous transmit until match frame found or match timer expired 1x _B CT , Continuous transmit
Res	11	ro	Reserved 0 _B DEF , Default
CRC	10	ro	Disable OAM CRC check 0 _B E , Enable (Default) 1 _B D , Disable
Res	9:8	ro	Reserved 00 _B DEF , Default
PFM_10	7:6	rw	Packet Filtering Mode for Received DA = 01 80 C2 00 00 10 ~ 01 80 C2 00 00 FF 0 _B DEF , Default
PFM_02	5:4	ro	Packet Filtering Mode for Received DA = 01 80 C2 00 00 02 ~ 01 80 C2 00 00 0F 1 _B DEF , Default
PFM_01	3:2	rw	Packet Filtering Mode for Received DA = 01 80 C2 00 00 01 and OPCODE != PAUSE 01 _B DEF , Default (Fixed)
PFM_00	1:0	rw	Packet Filtering Mode for Received DA = 01 80 C2 00 00 00 00 _B DEF , Default

Packet Filter Control Registers 1 and 0

PCFC_1_0 **Offset** **Reset Value**
Packet Filter Control Register 1 and 0 **0F_H** **0000_H**

15	14	13	12	11	10	9	8	7	6	5	4	3	2	1	0	
Res	AP1_R1	AP0_R1	OPC_1A				Res	AP1_R1	AP1_R1	OPC_19						
ro	rw	ro	ro				ro	rw	rw	rw						

Field	Bits	Type	Description
Res	15	ro	Reserved
AP1_R1	14	rw	Apply to Port 1 Rx 1 0 _B DNA, Do not apply 1 _B APL, Apply
AP0_R1	13	ro	Apply to Port 0 Rx 1 0 _B DNA, Do not apply 1 _B APL, Apply
OPC_1A	12:8	ro	OP Code for Filter Defined in Register 1A _H (1C _H , 1E _H , 20 _H , 22 _H , 24 _H , 26 _H , 28 _H)
Res	7	ro	Reserved
AP1_R1	6	rw	Apply to Port 1 Rx 1 0 _B DNA, Do not apply 1 _B APL, Apply
AP1_R1	5	rw	Apply to Port 0 Rx 1 0 _B DNA, Do not apply 1 _B APL, Apply
OPC_19	4:0	rw	OP Code for Filter which defined in Register 19 _H (1B _H , 1D _H , 1F _H , 21 _H , 23 _H , 25 _H , 27 _H)

Other Packet Filter Control Registers have the same structure and characteristics as [Packet Filter Control Registers 1 and 0](#); the offset addresses are listed in [Table 18](#).

Table 18 Other Packet Filter Control Registers

Register Short Name	Register Long Name	Offset Address	Page Number
PCFC_3_2	Packet Filter Control Registers 3 and 2	10 _H	
PCFC_5_4	Packet Filter Control Registers 5 and 4	11 _H	
PCFC_7_6	Packet Filter Control Registers 7 and 6	12 _H	
PCFC_9_8	Packet Filter Control Registers 9 and 8	13 _H	
PCFC_11_10	Packet Filter Control Registers 11 and 10	14 _H	
PCFC_13_12	Packet Filter Control Registers 13 and 12	15 _H	
PCFC_15_14	Packet Filter Control Registers 15 and 14	16 _H	

Filter Type Register 0

TFTR_0 **Offset** **Reset Value**
Filter Type Register 0 **17_H** **0000_H**

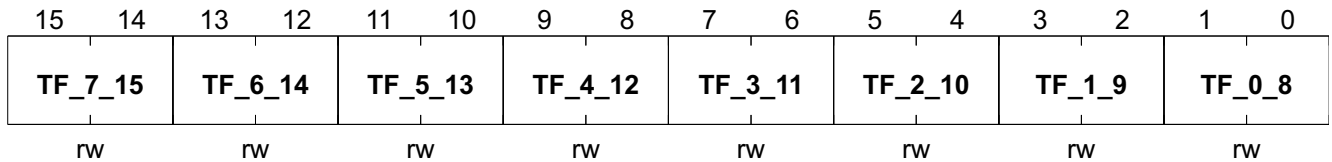

Field	Bits	Type	Description
TF_7_15	15:14	rw	Type of Filter 7
TF_6_14	13:12	rw	Type of Filter 6
TF_5_13	11:10	rw	Type of Filter 5
TF_4_12	9:8	rw	Type of Filter 4
TF_3_11	7:6	rw	Type of Filter 3
TF_2_10	5:4	rw	Type of Filter 2
TF_1_9	3:2	rw	Type of Filter 1
TF_0_8	1:0	rw	Type of Filter 0

Filter Type Register 1

TFTR_1 **Offset** **Reset Value**
Filter Type Register 1 **18_H** **0000_H**

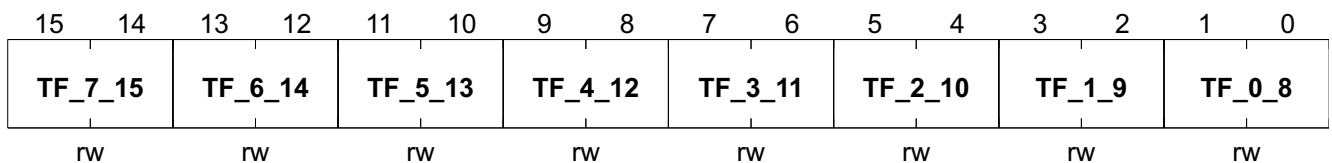

Field	Bits	Type	Description
TF_7_15	15:14	rw	Type of Filter 15
TF_6_14	13:12	rw	Type of Filter 14
TF_5_13	11:10	rw	Type of Filter 13
TF_4_12	9:8	rw	Type of Filter 12
TF_3_11	7:6	rw	Type of Filter 11
TF_2_10	5:4	rw	Type of Filter 10
TF_1_9	3:2	rw	Type of Filter 9
TF_0_8	1:0	rw	Type of Filter 8

Filter Register 0

FR_0 **Offset**
Filter Register 0 **19_H** **Reset Value**
0000_H

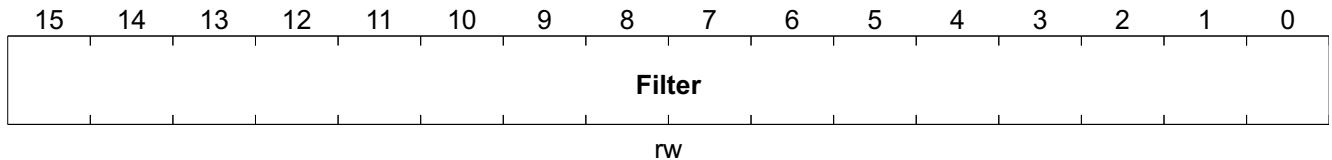

Field	Bits	Type	Description
Filter	15:0	rw	Filter

Other Filter Registers have the same structure and characteristics as **Filter Register 0**; the offset addresses are listed in [Table 19](#).

Table 19 Other Filter Registers

Register Short Name	Register Long Name	Offset Address	Page Number
FR_1	Filter Register 1	1A _H	
FR_2	Filter Register 2	1B _H	
FR_3	Filter Register 3	1C _H	
FR_4	Filter Register 4	1D _H	
FR_5	Filter Register 5	1E _H	
FR_6	Filter Register 6	1F _H	
FR_7	Filter Register 7	20 _H	
FR_8	Filter Register 8	21 _H	
FR_9	Filter Register 9	22 _H	
FR_10	Filter Register 10	23 _H	
FR_11	Filter Register 11	24 _H	
FR_12	Filter Register 12	25 _H	
FR_13	Filter Register 13	26 _H	
FR_14	Filter Register 14	27 _H	
FR_15	Filter Register 15	28 _H	

Port Base VLAN ID and Mask 0 of Port 0

PB_ID_0_0	Offset	Reset Value
Port Base VLAN ID and Mask 0 of Port 0	29_H	0001_H

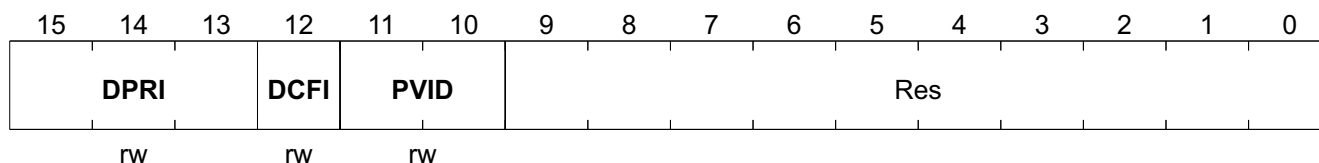

Field	Bits	Type	Description
DPRI	15:13	rw	DPRI Default Priority
DCFI	12	rw	DCFI Default CFI
PVID	11:10	rw	PVID Port base VLAN ID 01 _B DEF, Default

Port Base VLAN ID and Mask 0 of Port 1

PB_ID_1_0	Offset	Reset Value
Port Base VLAN ID and Mask 1 of Port 0	2A_H	0000_H

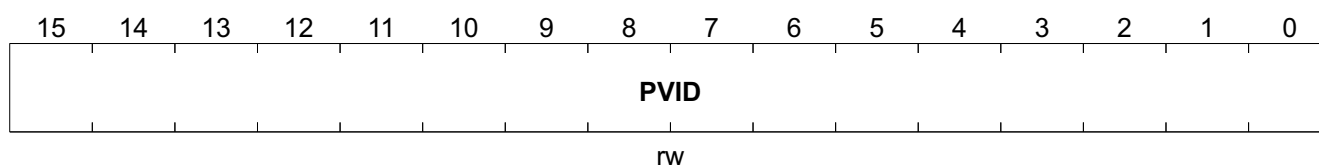

Field	Bits	Type	Description
PVID	15:0	rw	PVID Mask

Port Base VLAN ID and Mask 0 of Port 1

PB_ID_0_1 **Offset**
Port Base VLAN ID and Mask 0 of Port 1 **2B_H** **Reset Value**
0001_H

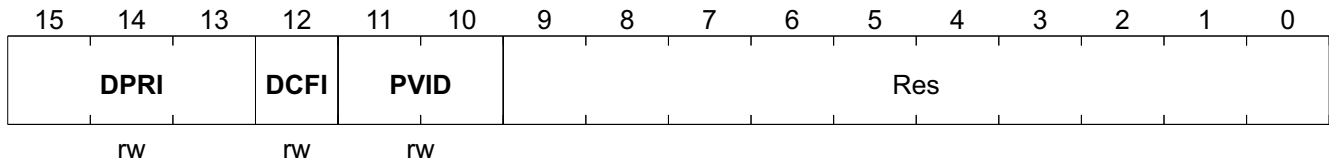

Field	Bits	Type	Description
DPRI	15:13	rw	DPRI Default Priority
DCFI	12	rw	DCFI Default CFI
PVID	11:10	rw	PVID Port base VLAN ID 01 _B DEF, Default

Port Base VLAN ID and Mask 1 of Port 1

PB_ID_1_1 **Offset**
Port Base VLAN ID and Mask 1 of Port 1 **2C_H** **Reset Value**
0000_H

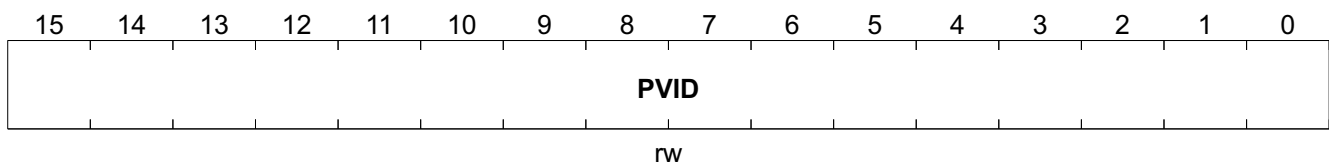

Field	Bits	Type	Description
PVID	15:0	rw	PVID Mask

Tag Port Rule 0 Register 0

TPR_0_0 **Offset**
Tag Port Rule 0 Register 0 **2D_H** **Reset Value**
F000_H

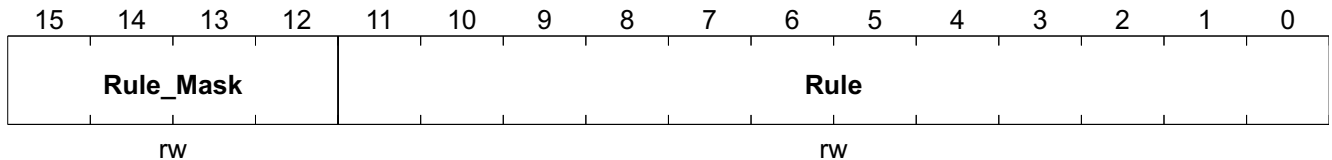

Field	Bits	Type	Description
Rule_Mask	15:12	rw	Rule Mask F _H D, Default
Rule	11:0	rw	Rule

Other Tag Port Rule 0 Registers have the same structure and characteristics as [Tag Port Rule 0 Register 0](#); the offset addresses are listed in [Table 20](#).

Table 20 Other Tag Port Rule 0 Registers

Register Short Name	Register Long Name	Offset Address	Page Number
TPR_0_1	Tag Port Rule 0 Register 1	2F _H	
TPR_0_2	Tag Port Rule 0 Register 2	31 _H	
TPR_0_3	Tag Port Rule 0 Register 3	33 _H	

Tag Port Rule 1 Register 0

TPR_1_0 **Offset**
Tag Port Rule 1 Register 0 **2E_H** **Reset Value**
00FF_H

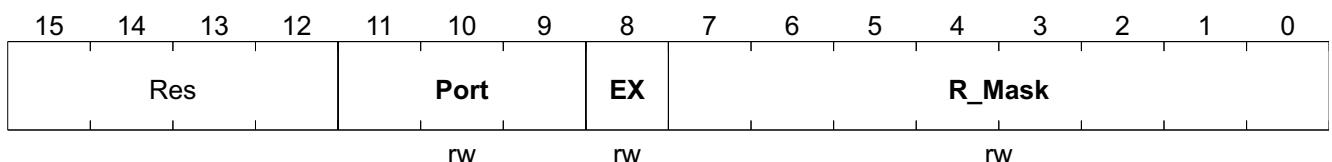

Field	Bits	Type	Description
Port	11:9	rw	Port to apply the rule
EX	8	rw	Exclude Rule
R_Mask	7:0	rw	Rule Mask[11:4]

Registers Description

Other Tag Port Rule 1 Registers have the same structure and characteristics as **Tag Port Rule 1 Register 0**; the offset addresses are listed in **Table 21**.

Table 21 Other Tag Port Rule 1 Registers

Register Short Name	Register Long Name	Offset Address	Page Number
TPR_1_1	Tag Port Rule 1 Register 1	30 _H	
TPR_1_2	Tag Port Rule 1 Register 2	32 _H	

Tag Port Rule 1 x

TPR_1x **Offset**
34_H
Tag Port Rule 1 x **Reset Value**
00FF_H

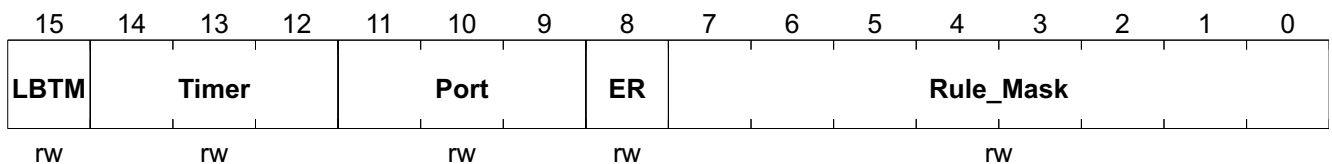

Field	Bits	Type	Description
LBTM	15	rw	Loop Back Test Mode 0 _B TBD, depends on current speed configuration to test 10M or 100M PHY (Default) 1 _B TBD, Always test 100M PHY
Timer	14:12	rw	Timer Timer to qualify power failure recovery status (second) 000 _B ~111 _B , 0~8 seconds 000 _B , 0 seconds (Default)
Port	11:9	rw	Port to apply the rule
ER	8	rw	Exclude Rule
Rule_Mask	7:0	rw	Rule Mask[11:4]

OAM Configuration Register 1

OAM_C_1 **Offset**
35_H
OAM Configuration Register 1 **Reset Value**
0380_H

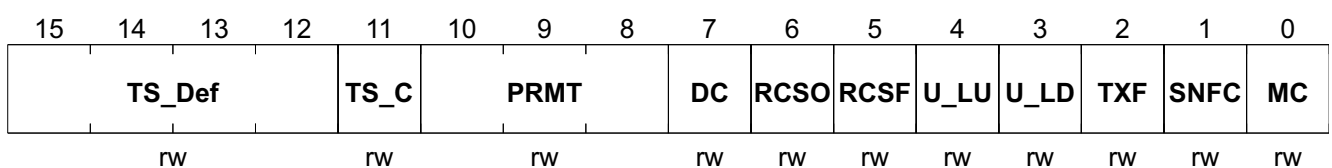

Registers Description

Field	Bits	Type	Description
TS_Def	15:12	rw	TS-1000 OAM C field Bit[4:7] Definition for Remote Control 0000 _B Z, Default
TS_C	11	rw	TS-1000 OAM C field Bit[1] Check 0 _B CD, Check direction of OAM frame (Default) 1 _B NC, Do not check direction of OAM frame
PRMT	10:8	rw	NINJA C (ADM6992C) Power Recovery Mask Timer when Power-On-Initial Timer for Mask OAM after power up and Port 1 link up (second) 000 _B ~111 _B , 0~8 seconds 011 _B , 3 seconds (Default)
DC	7	rw	NINJA C (ADM6992C) Power Detection Control 0 _B Z, Should be set 1 _B TBD,
RCSO	6	rw	NINJA C (ADM6992C) OAM Remote Control Stop OAM Enable 0 _B E, Enable Remote Control OAM (Default) 1 _B D, Disable Remote Control OAM
RCSF	5	rw	NINJA C (ADM6992C) OAM Remote Control Start Function Enable 0 _B D, Disable Remote Control (Default) 1 _B E, Enable Remote Control
U_LU	4	rw	TS-1000 OAM S field Bit[7:10] Definition when UTP link up 0 _B SHOW, S7-S8 and S9 of OAM frame show PHY status if PHY link up (Default) 1 _B NOT, S7-S8 and S9 of OAM frame don't show PHY status if PHY link up
U_LD	3	rw	TS-1000 OAM S field Bit[7:10] Definition when auto-negotiation enable and UTP link down 0 _B DIS, Disable idiot setting. NINJA C (ADM6992C) will send DIPSW setting to CO when UTP port auto-negotiation enable and link down (Default) 1 _B EIS, Enable idiot setting. NINJA C (ADM6992C) will always send 10MH to CO when UTP port auto-negotiation enable and link down
TXF	2	rw	Transmit MC_FAILURE when load EEPROM fail 0 _B TBD, Assert MC_FAILURE when load EEPROM fail (Default) 1 _B TBD, Don't assert MC_FAILURE when load EEPROM fail
SNFC	1	rw	NTT TS-1000 Status Notification Frame Control 0 _B TBD, Transmit one OAM frame if state change or state notification request frame is received. (Default) 1 _B TBD, Transmit three OAM frames if state change or state notification request frame is received.
MC	0	rw	NTT TS-1000 MC Mode Control 0 _B TBD, CPE mode (Default) 1 _B TBD, CO mode

OAM Configuration Register 2

NINJA C (ADM6992C) OAM C field Bit[8:15] definition for Remote Control

OAM_CR_2 **Offset**
OAM Configuration Register 2 **36_H** **Reset Value**
FEFF_H

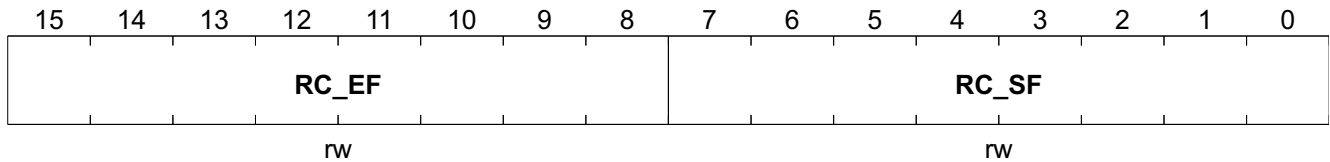

Field	Bits	Type	Description
RC_EF	15:8	rw	Remote Control End Function OAM C field Bit[8:15] definition FE _H EF , Default
RC_SF	7:0	rw	Remote Control Start Function OAM C field Bit[8:15] definition FF _H SF , Default

Miscellaneous Configuration Register 3

Vender ID

MCR_3 **Offset**
Miscellaneous Configuration Register 3 **37_H** **Reset Value**
0000_H

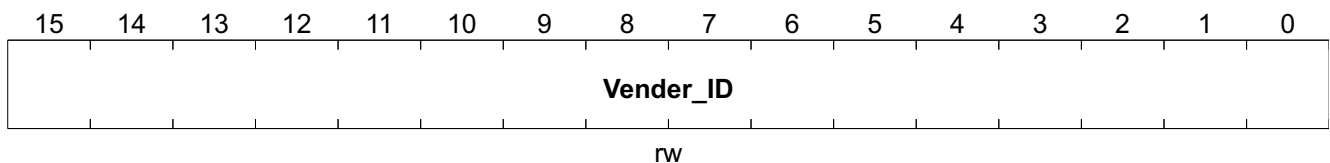

Field	Bits	Type	Description
Vender_ID	15:0	rw	NTT TS-1000 OAM M field Bit[15:0] definition Vender ID Bits

Miscellaneous Configuration Register 4

MCR_4 **Offset**
Miscellaneous Configuration 4 **38_H** **Reset Value**
0000_H

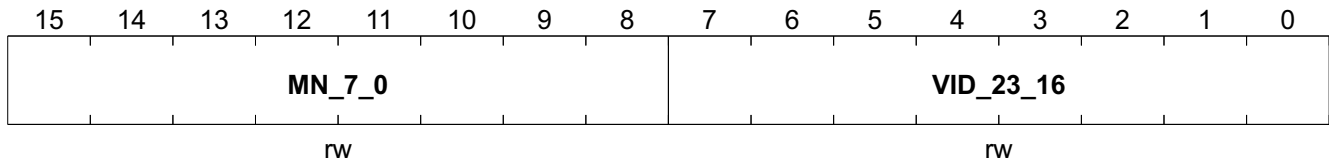

Field	Bits	Type	Description
MN_7_0	15:8	rw	NTT TS-1000 OAM M field Bit[31:24] definition Model Number Bit [7:0]
VID_23_16	7:0	rw	NTT TS-1000 OAM M field Bit[23:16] definition Vender ID Bit [23:16]

Miscellaneous Configuration Register 5

MCR_5 **Offset**
Miscellaneous Configuration Register 5 **39_H** **Reset Value**
0000_H

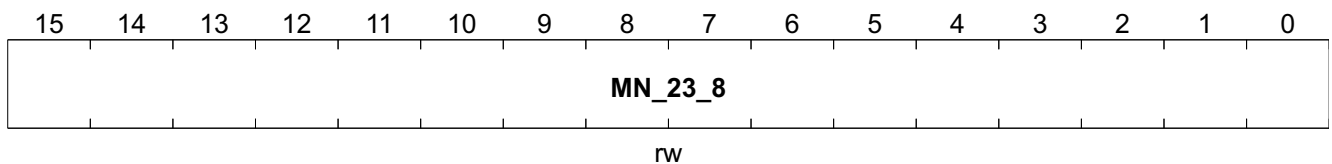

Field	Bits	Type	Description
MN_23_8	15:0	rw	NTT TS-1000 OAM M field Bit[47:32] definition Model Number Bits [23:8]

Forwarding Configuration 1

FC_1 **Offset** **Reset Value**
Forwarding Configuration 1 **3A_H** **6000_H**

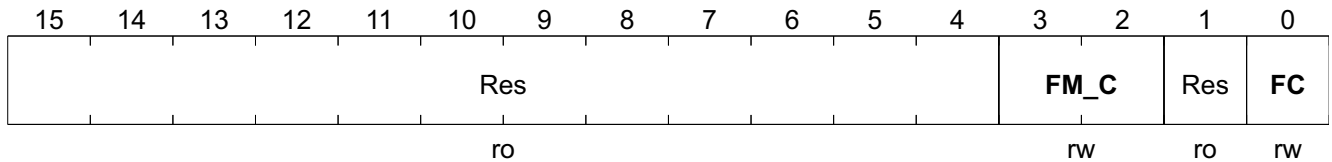

Field	Bits	Type	Description
Res	15:4	ro	Reserved 600 _H D , Default
FM_C	3:2	rw	Forwarding Mode Control 00 _B SF , Store & Forward (Default) 01 _B MCT , Modify Cut-Through 10 _B R , Reserved 11 _B MII , MII Cut-Through
Res	1	ro	Reserved 0 _B , Default
FC	0	rw	Forwarding Mode auto-change Control 0 _B FIX , Fix Forwarding Mode (Default) 1 _B A , Automatically Change Forwarding Mode

Forwarding Configuration 2

FC_2 **Offset** **Reset Value**
Forwarding Configuration 2 **3B_H** **0000_H**

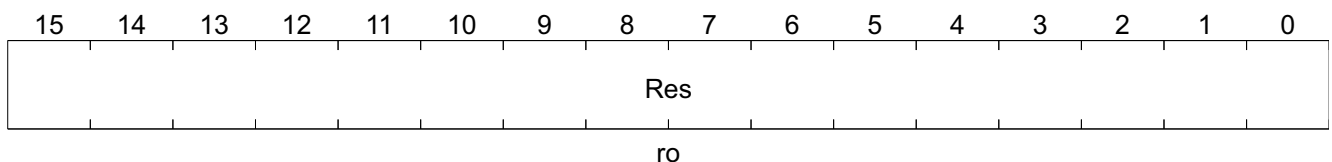

Field	Bits	Type	Description
Res	15:0	ro	Reserved 0000 _H Z , Default

Default Value Control Register

DV_CR	Offset	Reset Value
Default Value Control Register	3C_H	0000_H

15	14	13	12	11	10	9	8	7	6	5	4	3	2	1	0
PU_M	PS_D	PS_C	PM_T	IPG	IP_D	IP_F	BP	EO	DL	FX1	FX_0	LED_2	LED_1	LED_0	DIS
rw	rw	rw	rw	rw	rw	rw	rw	rw	rw	rw	rw	rw	rw	rw	rw

Field	Bits	Type	Description
PU_M	15	rw	Power up mask mode 0 _B TBD, by timer defined in EEPROM register 35 _H Bit[10:8] (Default) 1 _B TBD, by LED self test
PS_D	14	rw	Power status detect mode 0 _B TBD, mode 0 (Default) 1 _B TBD, mode 1
PS_C	13	rw	Power status change mask timer 0 _B TBD, the same with power up mask timer which defined in EEPROM register 35 _H Bit[10:8] (Default) 1 _B TBD, EEPROM register 34 _H Bit [14:12]
PM_T	12	rw	Power mask timer time base before first OAM was sent 0 _B TBD, 1 sec (Default) 1 _B TBD, 0.5 sec
IPG	11	rw	Place IPG 0 _B TBD, Place IPG before and after OAM frame and loop back test frame (Default) 1 _B TBD, Place IPG/2 before and after OAM frame and loop back test frame
IP_D	10	rw	Inverse Polarity of A_PD_DETECT 0 _B TBD, Disable inverse the polarity (Default) 1 _B TBD, Inverse the polarity
IP_F	9	rw	Inverse Polarity of MC_FAILURE 0 _B TBD, Disable inverse the polarity (Default) 1 _B TBD, Inverse the polarity
BP	8	rw	Polarity definition change for power-on-setting pin BYPASS_PAUSE 0 _B TBD, Disable inverse the default value (Default) 1 _B TBD, Inverse the default value
EO	7	rw	Polarity definition change for power-on-setting pin EN_OAM 0 _B TBD, Disable inverse the default value (Default) 1 _B TBD, Inverse the default value
DL	6	rw	Polarity definition change for power-on-setting pin DIS_LEARN 0 _B TBD, Disable inverse the default value of DIS_LEARN (Default) 1 _B TBD, Inverse the default value of DIS_LEARN

Field	Bits	Type	Description
FX1	5	rw	Polarity definition change for power-on-setting pin FXMODE[1] 0 _B TBD, Disable inverse the default value (Default) 1 _B TBD, Inverse the default value
FX_0	4	rw	Polarity definition change for power-on-setting pin FXMODE[0] 0 _B TBD, Disable inverse the default value (Default) 1 _B TBD, Inverse the default value
LED_2	3	rw	Polarity definition change for power-on-setting pin LEDMODE[2] 0 _B TBD, Disable inverse the default value (Default) 1 _B TBD, Inverse the default value
LED_1	2	rw	Polarity definition change for power-on-setting pin LEDMODE[1] 0 _B TBD, Disable inverse the default value (Default) 1 _B TBD, Inverse the default value
LED_0	1	rw	Polarity definition change for power-on-setting pin LEDMODE[0] 0 _B TBD, Disable inverse the default value (Default) 1 _B TBD, Inverse the default value
DIS	0	rw	Polarity definition change for power-on-setting pin DISBP_N 0 _B TBD, Disable inverse the default value (Default) 1 _B TBD, Inverse the default value

4.3 Serial Management Registers

Table 22 Serial Management Register Map

Register	Bit 31-0	Default Value
00 _H	Chip Identify	0002 1090 _H
01 _H	Over Flow Flag	0000 0000 _H
02 _H	P0 Receive packets	0000 0000 _H
03 _H	P0 Receive byte count	0000 0000 _H
04 _H	P0 Transmit packets	0000 0000 _H
05 _H	P0 Transmit byte count	0000 0000 _H
06 _H	P0 error count	0000 0000 _H
07 _H	P0 collision count	0000 0000 _H
08 _H	P1 Receive packets	0000 0000 _H
09 _H	P1 Receive byte count	0000 0000 _H
0A _H	P1 Transmit packets	0000 0000 _H
0B _H	P1 Transmit byte count	0000 0000 _H
0C _H	P1 error count	0000 0000 _H
0D _H	P1 collision count	0000 0000 _H
0E _H	Per Port Counter Reset	0000 0000 _H
0F _H	Hardware Settings	Pin
10 _H	Interrupt Register	0000 0000 _H
11 _H	Interrupt mask Register	0000 0000 _H
12 _H	Port Status	Real Time Status
13 _H	EEPROM Register File Access Control	0000 4154 _H

Table 22 Serial Management Register Map (cont'd)

Register	Bit 31-0	Default Value
14 _H	OAM Control Register	0000 0000 _H
15 _H	Source Address of Loop Back Test User Frame 0	0000 0000 _H
16 _H	Source Address of Loop Back Test User Frame 1	0000 0000 _H
17 _H	Transmit OAM Frame Register 0	0000 0000 _H
18 _H	Transmit OAM Frame Register 1	0000 0000 _H
19 _H	Transmit OAM Frame Register 2	0000 0000 _H
1A _H	Received OAM Frame Register 0	0000 0000 _H
1B _H	Received OAM Frame Register 1	0000 0000 _H
1C _H	Received OAM Frame Register 2	0000 0000 _H
1D _H	OAM Frame Status Register	0000 0000 _H

Note: Any write activity to counter register will reset the counter and the overflow flag of this counter.

4.4 Serial Management Register Descriptions

Table 23 Registers Address Space Registers Address Space

Module	Base Address	End Address	Note
Serial	00 _H	1D _H	

Table 24 Registers Overview

Register Short Name	Register Long Name	Offset Address	Page Number
Chip_ID	Chip Identifier	00 _H	60
OFR	Overflow Flag Register	01 _H	61
PCNR_0	Port 0 Counter Register	02 _H	62
P0RBC	P0 Receive byte count	03 _H	62
P0TP	P0 Transmit packets	04 _H	62
P0TBC	P0 Transmit byte count	05 _H	62
P0EC	P0 Error count	06 _H	62
P0CC	P0 Collision count	07 _H	62
P1RP	P1 Receive packets	08 _H	62
P1RBC	P1 Receive byte count	09 _H	62
P1TP	P1 Transmit packets	0A _H	62
P1TBC	P1 Transmit byte count	0B _H	62
P1EC	P1 Error count	0C _H	62
P1CC	P1 Collision count	0D _H	62
PCRR	Port Counter Reset Register	0E _H	62
HW_SSR	Hardware Setting Status Register	0F _H	64
INT	Interrupt Register	10 _H	65
INT_M	Interrupt Mask Register	11 _H	66
PSR	Port Status Register	12 _H	68
EE_RFAC	EEPROM Register File Access Control	13 _H	69
OAM_CR	OAM Control Register	14 _H	70
SA_F_0	Source Address of Loop Back Test User Frame 0	15 _H	71
SA_F_1	Source Address of Loop Back Test User Frame 1	16 _H	72
TFR_0	Transmit OAM Frame Register 0	17 _H	72
TFR_1	Transmit OAM Frame Register 1	18 _H	72
TFR_2	Transmit OAM Frame Register 2	19 _H	73
RFR_0	Received OAM Frame Register 0	1A _H	74
RFR_1	Received OAM Frame Register 1	1B _H	74
RFR_2	Received OAM Frame Register 0	1C _H	75
OAM_FSR	OAM Frame Status Register	1D _H	75

The register is addressed wordwise.

Table 25 Register Access Types

Mode	Symbol	Description HW	Description SW
read/write	rw	Register is used as input for the HW	Register is read and writable by SW
read	r	Register is written by HW (register between input and output -> one cycle delay)	Value written by software is ignored by hardware; that is, software may write any value to this field without affecting hardware behavior (= Target for development.)
Read only	ro	Register is set by HW (register between input and output -> one cycle delay)	SW can only read this register
Read virtual	rv	Physically, there is no new register, the input of the signal is connected directly to the address multiplexer.	SW can only read this register
Latch high, self clearing	lhsc	Latches high signal at high level, clear on read	SW can read the register
Latch low, self clearing	llsc	Latches high signal at low-level, clear on read	SW can read the register
Latch high, mask clearing	lhmk	Latches high signal at high level, register cleared with written mask	SW can read the register, with write mask the register can be cleared (1 clears)
Latch low, mask clearing	llmk	Latches high signal at low-level, register cleared on read	SW can read the register, with write mask the register can be cleared (1 clears)
Interrupt high, self clearing	ihsc	Differentiates the input signal (low->high) register cleared on read	SW can read the register
Interrupt low, self clearing	ilsc	Differentiates the input signal (high->low) register cleared on read	SW can read the register
Interrupt high, mask clearing	ihmk	Differentiates the input signal (high->low) register cleared with written mask	SW can read the register, with write mask the register can be cleared
Interrupt low, mask clearing	ilmk	Differentiates the input signal (low->high) register cleared with written mask	SW can read the register, with write mask the register can be cleared
Interrupt enable register	ien	Enables the interrupt source for interrupt generation	SW can read and write this register
latch_on_reset	lor	rw register, value is latched after first clock cycle after reset	Register is readable and writable by SW
Read/write self clearing	rwsc	Register is used as input for the hw, the register will be cleared due to a HW mechanism.	Writing to the register generates a strobe signal for the HW (1 pdi clock cycle) Register is readable and writable by SW.

Table 26 Registers Clock DomainsRegisters Clock Domains

Clock Short Name	Description

4.4.1 Serail Management Register Format

Chip Identifier

Registers Description

Chip_ID **Offset** **Reset Value**
Chip Identifier **00_H** **0002 1090_H**

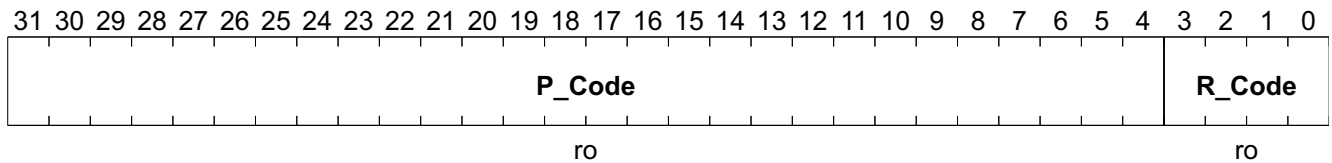

Field	Bits	Type	Description
P_Code	31:4	ro	Project Code
R_Code	3:0	ro	Revision Code

Overflow Flag Register

OFR **Offset** **Reset Value**
Overflow Flag Register **01_H** **0000 0000_H**

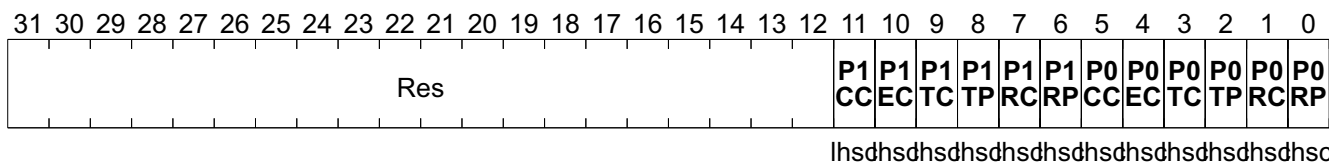

Field	Bits	Type	Description
P1CC	11	lhsc	P1 collision count 1 _B TBD, Overflow
P1EC	10	lhsc	P1 error count overflow 1 _B TBD, Overflow
P1TC	9	lhsc	P1 transmit byte count overflow 1 _B TBD, Overflow
P1TP	8	lhsc	P1 transmit packets overflow 1 _B TBD, Overflow
P1RC	7	lhsc	P1 Receive byte count overflow 1 _B TBD, Overflow
P1RP	6	lhsc	P1 Receive packets overflow 1 _B TBD, Overflow
P0CC	5	lhsc	P0 collision count overflow 1 _B TBD, Overflow
P0EC	4	lhsc	P0 error count overflow 1 _B TBD, Overflow
P0TC	3	lhsc	P0 Transmit byte count overflow 1 _B TBD, Overflow

Registers Description

Field	Bits	Type	Description
P0TP	2	lhsc	P0 Transmit packets overflow 1 _B TBD, Overflow
P0RC	1	lhsc	P0 Receive byte count overflow 1 _B TBD, Overflow
P0RP	0	lhsc	P0 Receive packets overflow 1 _B TBD, Overflow

Port 0 Counter Register

PCNR_0	Offset	Reset Value
Port 0 Counter Register	02_H	0000 0000_H

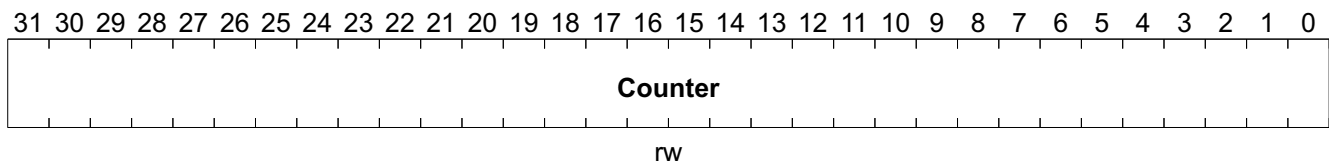

Field	Bits	Type	Description
Counter	31:0	rw	Counter

Other Counter Registers have the same structure and characteristics as **Port 0 Counter Register**; the names and offset addresses are listed in [Table 27](#).

Table 27 Other Counter Registers

Register Short Name	Register Long Name	Offset Address	Page Number
P0RBC	P0 Receive byte count	03 _H	
P0TP	P0 Transmit packets	04 _H	
P0TBC	P0 Transmit byte count	05 _H	
P0EC	P0 Error count	06 _H	
P0CC	P0 Collision count	07 _H	
P1RP	P1 Receive packets	08 _H	
P1RBC	P1 Receive byte count	09 _H	
P1TP	P1 Transmit packets	0A _H	
P1TBC	P1 Transmit byte count	0B _H	
P1EC	P1 Error count	0C _H	
P1CC	P1 Collision count	0D _H	

Port Counter Reset Register

Registers Description

Interrupt Register

INT **Offset** **Reset Value**
Interrupt Register **10_H** **0000 0000_H**

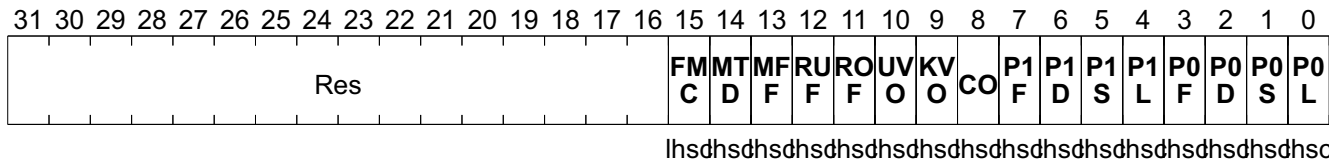

Field	Bits	Type	Description
FMC	15	lhsc	Forwarding Mode Change
MTD	14	lhsc	Match Timer Done
MFF	13	lhsc	Match Frame Found
RUF	12	lhsc	Request User Frame transmitted.
ROF	11	lhsc	Request OAM Frame transmitted.
UVO	10	lhsc	Unknown Valid OAM Frame received
KVO	9	lhsc	Known Valid OAM Frame received
CO	8	lhsc	Counter Overflow 0 _B TBD, Normal 1 _B TBD, Any counter defined in register 0x02~0x0e overflow
P1F	7	lhsc	Port 1 Flow Control Ability Change 0 _B N, Normal 1 _B SC, Status change
P1D	6	lhsc	Port 1 Duplex Change 0 _B N, Normal 1 _B SC, Status change
P1S	5	lhsc	Port 1 Speed Change 0 _B N, Normal 1 _B SC, Status change
P1L	4	lhsc	Port 1 Link Status Change 0 _B N, Normal 1 _B SC, Status change
P0F	3	lhsc	Port 0 Flow Control Ability Change 0 _B N, Normal 1 _B SC, Status change)
P0D	2	lhsc	Port 0 Duplex Change 0 _B N, Normal 1 _B SC, Status change
P0S	1	lhsc	Port 0 Speed Change 0 _B N, Normal 1 _B SC, Status change

Registers Description

Field	Bits	Type	Description
POL	0	lhsc	Port 0 Link Status Change 0 _B N, Normal 1 _B SC, Status change

Interrupt Mask Register

INT_M	Offset	Reset Value
Interrupt Mask Register	11 _H	0000 0000 _H

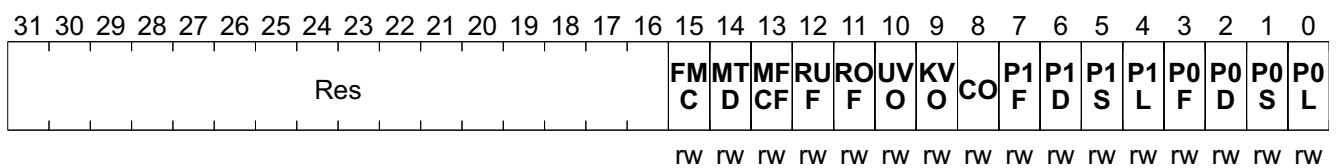

Field	Bits	Type	Description
FMC	15	rw	Forwarding Mode Change 0 _B D, Disable 1 _B E, Enable
MTD	14	rw	Match Timer Done 0 _B D, Disable 1 _B E, Enable
MFCF	13	rw	Match Frame Found 0 _B D, Disable 1 _B E, Enable
RUF	12	rw	Request User Frame transmitted 0 _B D, Disable 1 _B E, Enable
ROF	11	rw	Request OAM Frame transmitted 0 _B D, Disable 1 _B E, Enable
UVO	10	rw	Unknown Valid OAM Frame received 0 _B D, Disable 1 _B E, Enable
KVO	9	rw	Known Valid OAM Frame received 0 _B D, Disable 1 _B E, Enable
CO	8	rw	Counter Overflow 0 _B D, Disable 1 _B E, Enable
P1F	7	rw	Port 1 Flow Control Ability Change 0 _B D, Disable 1 _B E, Enable

Registers Description

Field	Bits	Type	Description
P1D	6	rw	Port 1 Duplex Change 0 _B D, Disable 1 _B E, Enable
P1S	5	rw	Port 1 Speed Change 0 _B D, Disable 1 _B E, Enable
P1L	4	rw	Port 1 Link Status Change 0 _B D, Disable 1 _B E, Enable
P0F	3	rw	Port 0 Flow Control Ability Change 0 _B D, Disable 1 _B E, Enable
P0D	2	rw	Port 0 Duplex Change 0 _B D, Disable 1 _B E, Enable
P0S	1	rw	Port 0 Speed Change 0 _B D, Disable 1 _B E, Enable
P0L	0	rw	Port 0 Link Status Change 0 _B D, Disable 1 _B E, Enable

Registers Description

Port Status Register

PSR	Offset	Reset Value
Port Status Register	12 _H	Real Time Status _H

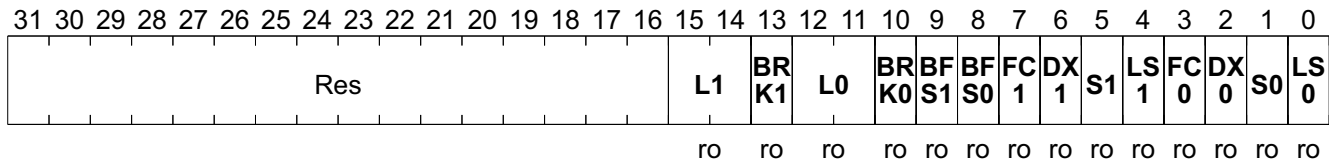

Field	Bits	Type	Description
L1	15:14	ro	CBBRK_LENGTH of P1 00 _B L1, 0~60m 01 _B L2, 60~90m 10 _B L3, 90~130m 11 _B L4, 130~170m
BRK1	13	ro	CBBRK of P1 0 _B N, Normal 1 _B CB, Cable Broken
L0	12:11	ro	CBBRK_LENGTH of P0 00 _B L1, 0~60m 01 _B L2, 60~90m 10 _B L3, 90~130m 11 _B L4, 130~170m
BRK0	10	ro	CBBRK of P0 0 _B N, Normal 1 _B CB, Cable Broken
BFS1	9	ro	Buffer Full Status of Port 1 0 _B N, Normal 1 _B BF, Buffer Full
BFS0	8	ro	Buffer Full Status of Port 0 0 _B N, Normal 1 _B BF, Buffer Full
FC1	7	ro	Flow Control of Port 1 0 _B D, Disable 1 _B E, Enable
DX1	6	ro	Duplex of Port 1 0 _B HD, Half Duplex 1 _B FD, Full Duplex
S1	5	ro	Speed of Port 1 0 _B 10M, 10M 1 _B 100M, 100M
LS1	4	ro	Link Status of Port 1 0 _B LD, Link Down 1 _B LU, Link Up

Registers Description

Field	Bits	Type	Description
FC0	3	ro	Flow Control of Port 0 0 _B D , Disable 1 _B E , Enable
DX0	2	ro	Duplex of Port 0 0 _B HD , Half Duplex 1 _B FD , Full Duplex
S0	1	ro	Speed of Port 0 0 _B 10M , 10M 1 _B 100M , 100M
LS0	0	ro	Link Status of Port 0 0 _B LD , Link Down 1 _B LU , Link Up

EEPROM Register File Access Control

EE_RFAC	Offset	Reset Value
EEPROM Register File Access Control	13 _H	0000 4154 _H

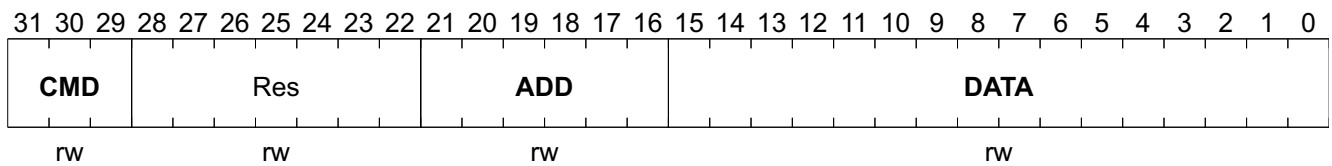

Field	Bits	Type	Description
CMD	31:29	rw	Command 000 _B R , Read 001 _B W , Write > 001 _B Res , Reserved
Res	28:22	rw	Reserved 0000000 _B Res , Reserved
ADD	21:16	rw	Address 00 _H to 3F _H
DATA	15:0	rw	Data

OAM Control Register

OAM_CR	Offset	Reset Value
OAM Control Register	14 _H	0000 0000 _H

31	30	29	28	27	26	25	24	23	22	21	20	19	18	17	16	15	14	13	12	11	10	9	8	7	6	5	4	3	2	1	0
Res																			FCK	FCU	LB	TC	LB_HC			TC	BT	EAM	EAC	EKO	
																			rw	rw	rw	rw	rw			rw	rw	rw	rw	rw	rw

Field	Bits	Type	Description
FCK	12	rw	OAM FIFO Control for NTT TS-1000 frame 0 _B SK, Store known OAM frame to FIFO (Default) 1 _B N, Do not store
FCU	11	rw	OAM FIFO Control for unknown frame 0 _B SU, Store unknown OAM frame to FIFO (Default) 1 _B N, Do not store
LB	10	rw	Loop Back Test User Frame Transmit Control 0 _B N, Normal (Default) 1 _B REQ, Request to transmit an user frame which the SA is defined in SMI register 15 _H and 16 _H . After the request user frame is transmitted, this bit is cleared.
TC	9	rw	OAM frame Transmit control 0 _B N, Normal (Default) 1 _B REQ, Request to transmit an OAM frame which is defined in SMI register 17 _H , 18 _H and 19 _H . After the request OAM frame is transmitted, this bit is cleared.
LB_HC	8:5	rw	Loop Back Test User Frame Handling Control 0000 _B D, Disable (Default) NNNN _B N, Find the first valid received Ethernet frame with its CRC. It is the same with the most recently transmitted Ethernet frame during NNNN*10ms After the frame is found or the timer count done, the register will be cleared. And the search result will be stored to Register 1D _H Bit [1:0].
TC	4	rw	Discard all Ethernet frame from FX control 0 _B N, Normal (Default) 1 _B DE, Discard all Ethernet frame received from Port1
BT	3	rw	Block the traffic from TP to FX control 0 _B N, Normal (Default) 1 _B BT, Block the traffic from Port0 to Port1
EAM	2	rw	Enable Auto M field NTT TS-1000 OAM Vendor ID/Model Number by embedded OAM engine 0 _B E, Enable (Default) 1 _B D, Disable

Registers Description

Field	Bits	Type	Description
EAC	1	rw	Enable Auto CRC NTT TS-1000 OAM CRC by embedded OAM engin 0 _B E , Enable (Default) 1 _B D , Disable
EKO	0	rw	Enable Known OAM Frame Handling NTT TS-1000 OAM Frame by embedded OAM engine 0 _B E , Enable(Default) 1 _B D , Disable

Source Address of Loop Back Test User Frame 0

SA_F_0	Offset	Reset Value
Source Address of Loop Back Test User Frame 0	15 _H	0000 0000 _H

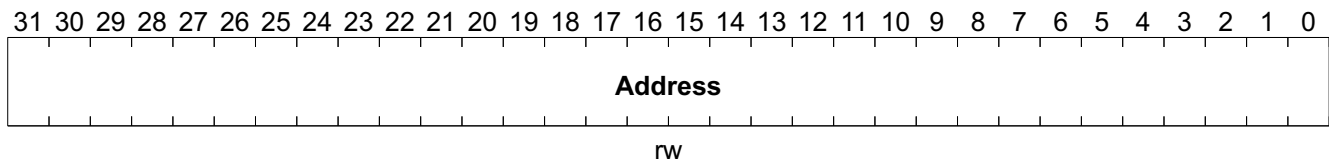

Field	Bits	Type	Description
Address	31:0	rw	Source Address[31:0]

Source Address of Loop Back Test User Frame 1

SA_F_1 **Offset** **Reset Value**
Source Address of Loop Back Test User **16_H** **0000 0000_H**
Frame 1

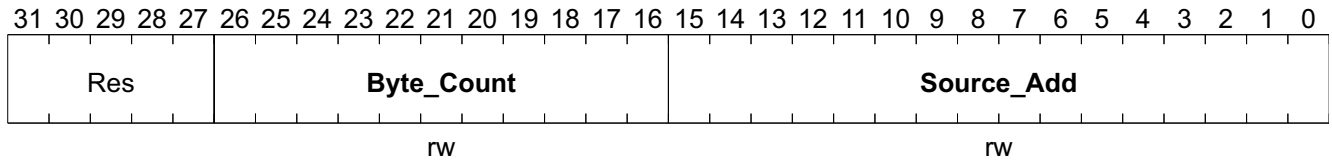

Field	Bits	Type	Description
Byte_Count	26:16	rw	Total Byte Count of payload Valid Ethernet frame : 46 byte ~ 1500 byte
Source_Add	15:0	rw	Source Address SA[47:32]

Transmit OAM Frame Register 0

TFR_0 **Offset** **Reset Value**
Transmit OAM Frame Register 0 **17_H** **0000 0000_H**

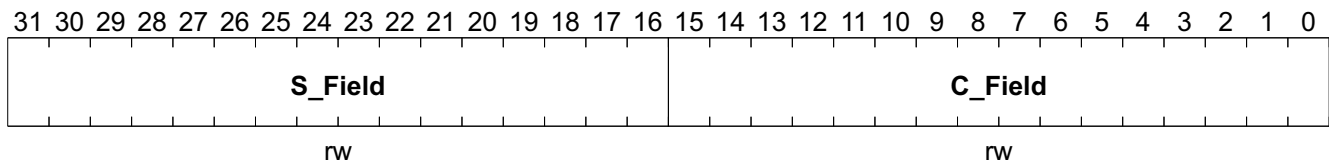

Field	Bits	Type	Description
S_Field	31:16	rw	S Field of OAM Frame
C_Field	15:0	rw	C Field of OAM Frame

Transmit OAM Frame Register 1

TFR_1 **Offset** **Reset Value**
Transmit OAM Frame Register 1 **18_H** **0000 0000_H**

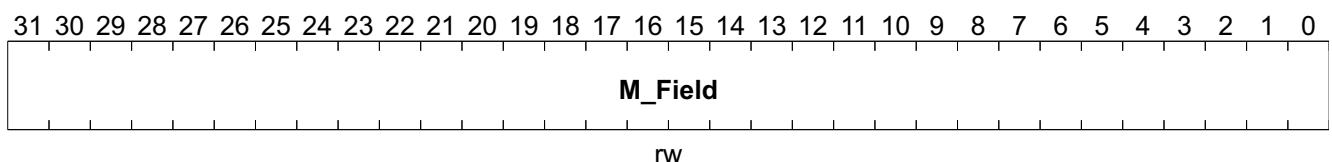

Field	Bits	Type	Description
M_Field	31:0	rw	M Field Bit [31:0] of OAM Frame

Transmit OAM Frame Register 2

TFR_2	Offset	Reset Value
Transmit OAM Frame Register 2	19_H	0000 0000_H

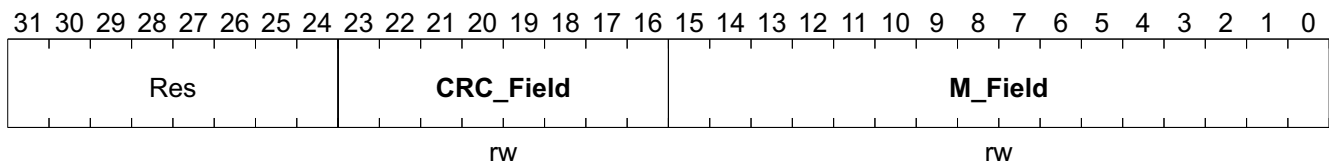

Field	Bits	Type	Description
CRC_Field	23:16	rw	CRC Field of OAM Frame
M_Field	15:0	rw	M Field Bit [47:32] of OAM Frame

Received OAM Frame Register 2

RFR_2 **Offset** **Reset Value**
Received OAM Frame Register 0 **1C_H** **0000 0000_H**

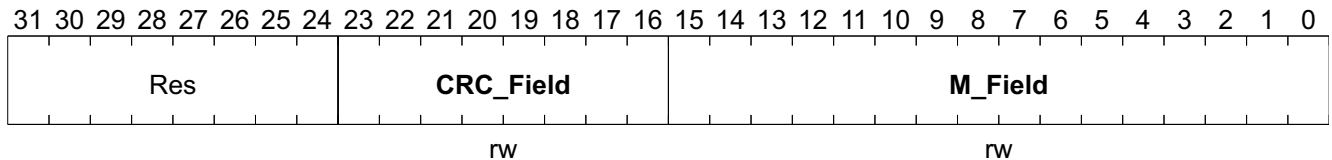

Field	Bits	Type	Description
CRC_Field	23:16	rw	CRC Field of Received OAM Frame
M_Field	15:0	rw	M Field Bit [47:32] of Received OAM Frame

OAM Frame Status Register

OAM_FSR **Offset** **Reset Value**
OAM Frame Status Register **1D_H** **0000 0000_H**

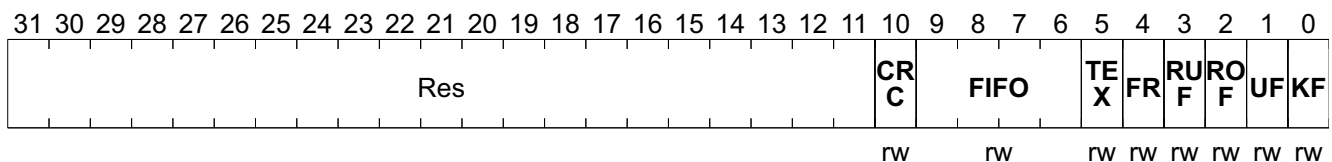

Field	Bits	Type	Description
CRC	10	rw	Bad CRC OAM Received 0 _B NB , No bad CRC OAM received 1 _B B , Bad CRC OAM received
FIFO	9:6	rw	Embedded OAM FIFO Utilization 0000 _B E , FIFO empty 1000 _B 25 , 25% 1100 _B 50 , 50% 1110 _B 75 , 75% 1111 _B F , FIFO full
TEX	5	rw	Status of Loop Back Test Timer 0 _B NOT , Timer does not expire before a matched frame is found 1 _B YES , Timer expires before a matched frame is found
FR	4	rw	Status of Loop Back Test User Frame 0 _B NF , Matched frame is not found 1 _B F , Matched frame is found
RUF	3	rw	Request User Frame transmitted
ROF	2	rw	Request OAM Frame transmitted

Registers Description

Field	Bits	Type	Description
UF	1	rw	Unknown Valid OAM Frame received
KF	0	rw	Known Valid OAM Frame received

5 Electrical Specification

DC and AC.

5.1 DC Characterization

Table 28 Electrical Absolute Maximum Rating

Parameter	Symbol	Values			Unit	Note / Test Condition
		Min.	Typ.	Max.		
Power Supply	V_{CC}	-0.3		3.6	V	
Input Voltage	V_{IN}	-0.3		$V_{CC} + 0.3$	V	
Output Voltage	V_{out}	-0.3		$V_{CC} + 0.3$	V	
Storage Temperature	T_{STG}	-55		155	°C	
Power Dissipation	PD			990	mW	
ESD Rating	ESD			2	KV	

Table 29 Recommended Operating Conditions

Parameter	Symbol	Values			Unit	Note / Test Condition
		Min.	Typ.	Max.		
Power Supply ¹⁾	V_{cc}	3.135	3.3	3.465	V	
Core Power Supply ²⁾	V_{core}	1.71	1.8	1.89		
Input Voltage	V_{in}	0	-	V_{cc}	V	
Junction Operating Temperature	T_j	0	25	115	°C	

1) VCC30. VCCBIAS

2) VCCIK. VCCA2. VCCPLL

Table 30 DC Electrical Characteristics for 3.3 V Operation¹⁾

Parameter	Symbol	Values			Unit	Note / Test Condition
		Min.	Typ.	Max.		
Input Low Voltage	V_{IL}			0.8	V	TTL
Input High Voltage	V_{IH}	2.0			V	TTL
Output Low Voltage	V_{OL}			0.4	V	TTL
Output High Voltage	V_{OH}	2.4			V	TTL
Input Pull_up/down Resistance	RI		50		KΩ	$V_{IL} = 0\text{ V}$ or $V_{IH} = V_{cc}$

1) Under $V_{CC} = 3.0\text{ V} \sim 3.6\text{ V}$, $T_j = \text{°C} \sim 115\text{ °C}$

5.2 AC Characterization

Power on Reset Timing, EEPROM Interface Timing, and SMI Timing.

Power on Reset Timing

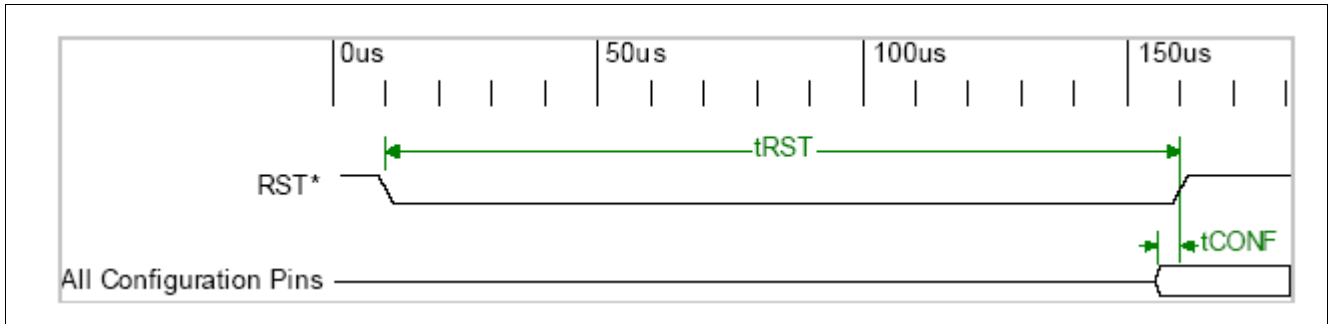

Figure 5 Power on Reset Timing

Table 31 Power on Reset Tmng

Parameter	Symbol	Values			Unit	Note / Test Condition
		Min.	Typ.	Max.		
RST Low Period	t_{RST}	100			ms	TTL
Start of Idle Pulse Width	t_{CONF}	100			ns	TTL

EEPROM Interface Timing

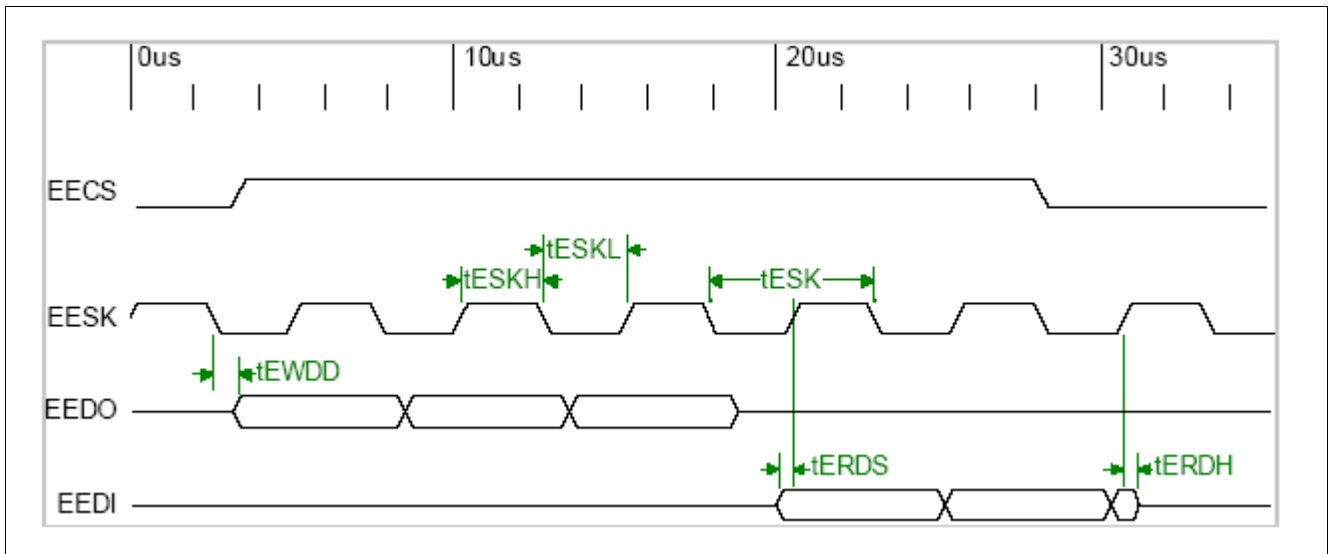

Figure 6 EEPROM Interface Timing

Table 32 EEPROM Interface Timing

Parameter	Symbol	Values			Unit	Note / Test Condition
		Min.	Typ.	Max.		
EESK Period	t_{ESK}		5120		ns	
EESK Low Period	t_{ESKL}	2550		2570	ns	
EESK High Period	t_{ESKH}	2550		2570	ns	
EEDI to EESK Rising Setup Time	t_{ERDS}	10			ns	

Table 32 EEPROM Interface Timing (cont'd)

Parameter	Symbol	Values			Unit	Note / Test Condition
		Min.	Typ.	Max.		
EEDI to EESK Rising Hold Time	t_{ERDH}	10			ns	
EESK Falling to EEDO Output Delay Time	t_{EWDD}			20	ns	

SMI Timing

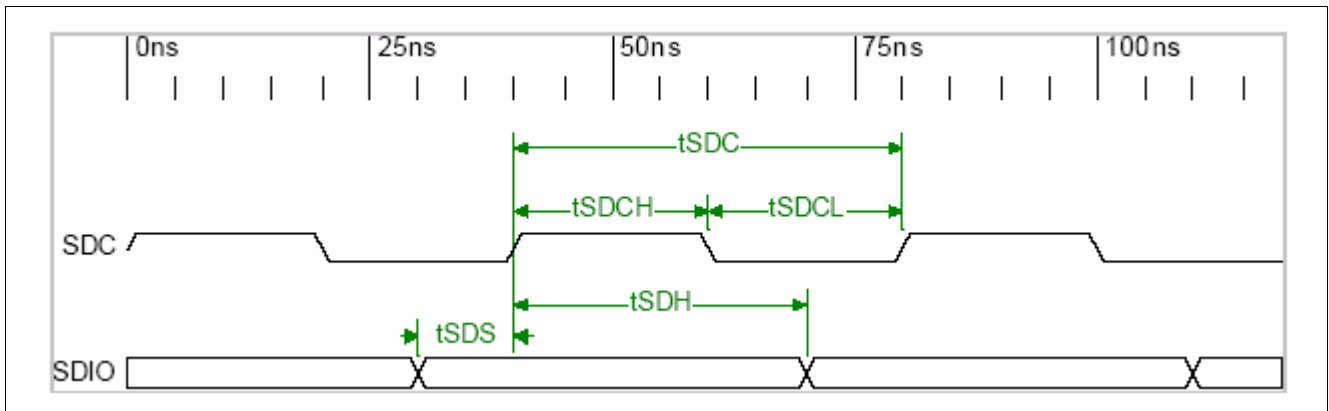

Figure 7 SMI Timing

Table 33 SMI Timing

Parameter	Symbol	Values			Unit	Note / Test Condition
		Min.	Typ.	Max.		
SDC Period	t_{CK}	20			ns	
SDC Low Period	t_{CKL}	10			ns	
SDC High Period	t_{CKH}	10			ns	
SDIO to SDC rising setup time on read/write cycle	t_{SDS}	4			ns	
SDIO to SDC rising hold time on read/write cycle	t_{SDH}	2			ns	

6 Packaging

128 PQFP Packaging for NINJA F/FX (ADM6992F/FX)

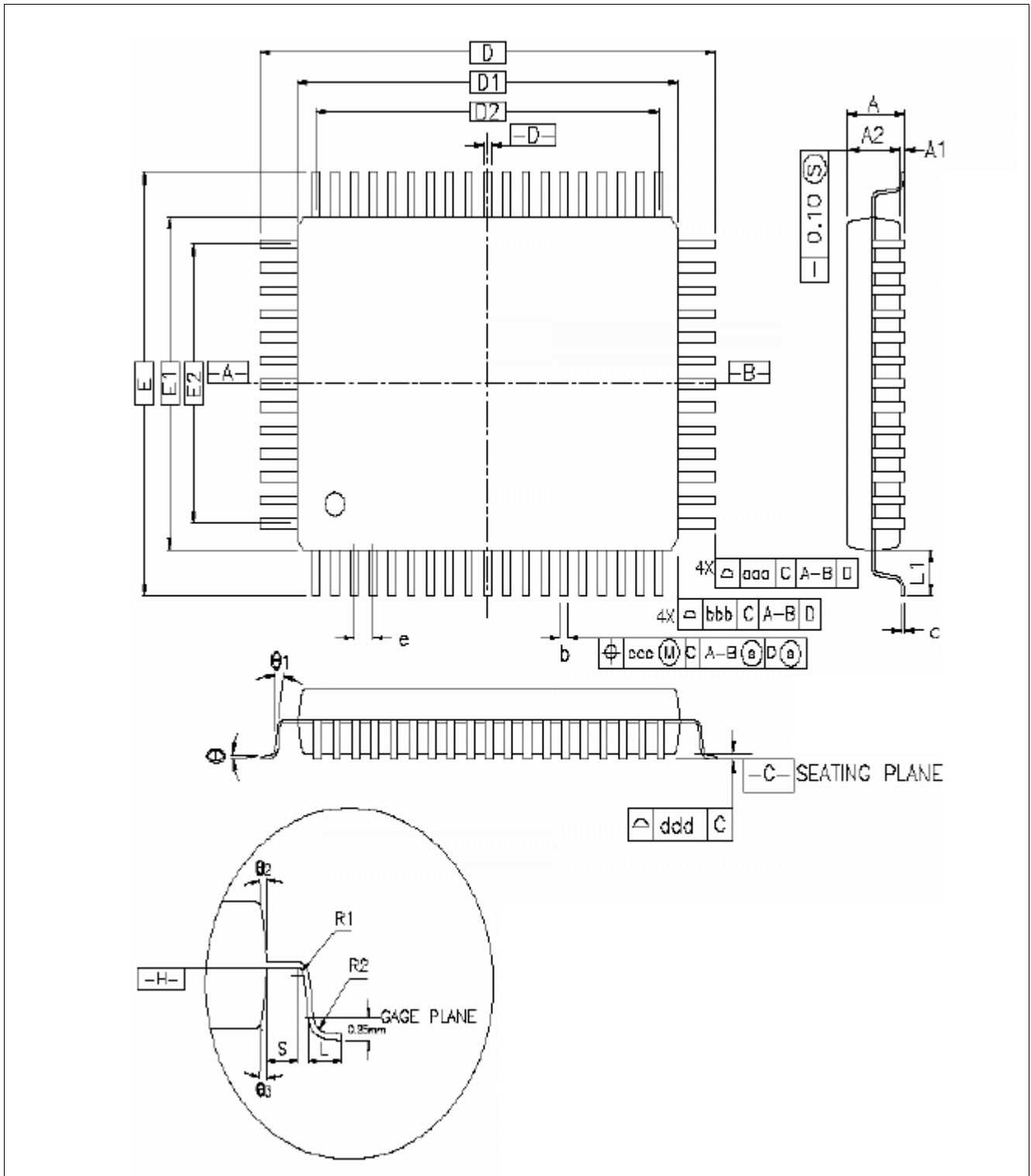

Figure 8 128 pin QFP Outside Dimension

Table 34 Dimensions for 128 PQFP Outside Dimension

Symbol	Millimeter (mm)			Inch		
	Min.	Typ.	Max.	Min.	Typ.	Max.
A	–	–	3.40	–	–	0.134
A ₁	0.25	–	0.15	0.001	–	–
A ₂	2.50	2.72	2.90	0.098	0.107	0.114
D	23.20 BSC.			0.913 BSC.		
D ₁	20.00 BSC			0.787 BSC.		
E	17.20 BSC			0.677 BSC.		
E ₁	14.00 BSC			0.551 BSC.		
R ₂	0.13	–	0.30	0.005	–	0.012
R ₁	0.13	–	–	0.005	–	–
Θ	0°	–	7°	0°	–	7°
Θ ₁	0°	–	–	0°	–	–
Alloy 42 L/F Θ ₂ ,Θ ₃	7° REF			7° REF		
Copper L/F Θ ₂ ,Θ ₃	15° REF			15° REF		
c	0.11	0.15	0.23	0.004	0.006	0.009
L	0.73	0.88	1.03	0.029	0.035	0.041
L ₁	1.60 Ref.			0.063 Ref.		
S	0.20	–	–	0.008	–	–
128L						
b	0.17	0.20	0.27	0.007	0.008	0.011
e	0.50 BSC.			0.020 BSC.		
D ₂	18.50			0.728		
E ₂	12.50			0.492		
Tolerance of Form and Position						
aaa	0.20			0.008		
bbb	0.20			0.008		
ccc	0.08			0.003		
ddd	0.08			0.003		

Note:

1. Dimensions D₁ and E₁ do not include mold protrusion. Allowable protrusion is 0.25mm per side. Dimensions D₁ and E₁ do include mold mismatch and are determined at datum plane. -H-
2. Dimensions b does not include dambar protrusion. Allowable dambar protrusion shall be 0.08mm. Total in excess of the b dimension at maximum material condition. Dambar can not be located on the lower radius or the lead foot.

www.infineon.com