

FEATURES

- 6-Phase Vertical Transfer Clock Support**
- Correlated Double Sampler (CDS)**
- 6 dB to 42 dB 10-Bit Variable Gain Amplifier (VGA)**
- 12-Bit 36 MHz A/D Converter**
- Black Level Clamp with Variable Level Control**
- Complete On-Chip Timing Generator**
- Precision Timing Core with <600 ps Resolution**
- On-Chip 3 V Horizontal and RG Drivers**
- 2-Phase and 4-Phase H-Clock Modes**
- Electronic and Mechanical Shutter Modes**
- On-Chip Driver for External Crystal**
- On-Chip Sync Generator with External Sync Input**
- 56-Lead LFCSP Package**

APPLICATIONS

- Digital Still Cameras**
- Digital Video Camcorders**
- Industrial Imaging**

GENERAL DESCRIPTION

The AD9995 is a highly integrated CCD signal processor for digital still camera and camcorder applications. It includes a complete analog front end with A/D conversion, combined with a full-function programmable timing generator. The timing generator is capable of supporting both 4- and 6-phase vertical clocking. A Precision Timing core allows adjustment of high speed clocks with less than 600 ps resolution at 36 MHz operation.

The AD9995 is specified at pixel rates of up to 36 MHz. The analog front end includes black level clamping, CDS, VGA, and a 12-bit A/D converter. The timing generator provides all the necessary CCD clocks: RG, H-clocks, V-clocks, sensor gate pulses, substrate clock, and substrate bias control. Operation is programmed using a 3-wire serial interface.

Packaged in a space-saving 56-lead LFCSP, the AD9995 is specified over an operating temperature range of -20°C to +85°C.

FUNCTIONAL BLOCK DIAGRAM

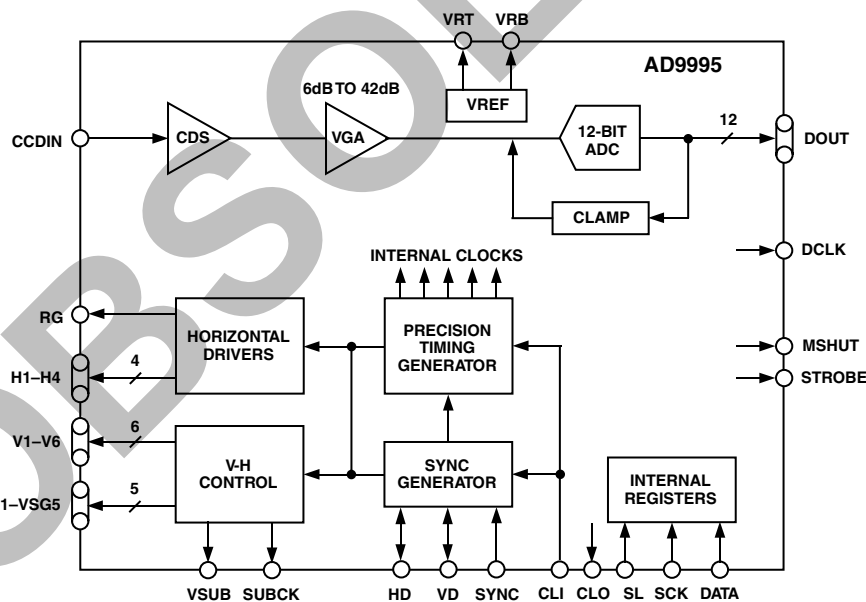

REV. 0

Information furnished by Analog Devices is believed to be accurate and reliable. However, no responsibility is assumed by Analog Devices for its use, nor for any infringements of patents or other rights of third parties that may result from its use. No license is granted by implication or otherwise under any patent or patent rights of Analog Devices. Trademarks and registered trademarks are the property of their respective owners.

AD9995

TABLE OF CONTENTS

SPECIFICATIONS	3	VERTICAL TIMING EXAMPLE	24
Digital Specifications	3	Important Note about Signal Polarities	24
AD9995 Analog Specifications	4	SHUTTER TIMING CONTROL	26
Timing Specifications	5	Normal Shutter Operation	26
ABSOLUTE MAXIMUM RATINGS	5	High Precision Shutter Operation	26
PACKAGE THERMAL CHARACTERISTICS	5	Low Speed Shutter Operation	26
ORDERING GUIDE	5	SUBCK Suppression	27
PIN CONFIGURATION	6	Readout after Exposure	27
PIN FUNCTION DESCRIPTIONS	6	Using the TRIGGER Register	27
TERMINOLOGY	7	VSub Control	28
EQUIVALENT CIRCUITS	7	MSHUT and STROBE Control	28
TYPICAL PERFORMANCE CHARACTERISTICS	8	TRIGGER Register Limitations	29
SYSTEM OVERVIEW	9	EXPOSURE AND READOUT EXAMPLE	30
PRECISION TIMING HIGH SPEED TIMING		AFE DESCRIPTION AND OPERATION	31
GENERATION	10	DC Restore	31
Timing Resolution	10	Correlated Double Sampler	31
High Speed Clock Programmability	10	Variable Gain Amplifier	31
H-Driver and RG Outputs	11	A/D Converter	32
Digital Data Outputs	11	Optical Black Clamp	32
HORIZONTAL CLAMPING AND BLANKING	13	Digital Data Outputs	32
Individual CLPOB and PBLK Patterns	13	POWER-UP AND SYNCHRONIZATION	33
Individual HBLK Patterns	13	Recommended Power-Up Sequence for Master Mode	33
Generating Special HBLK Patterns	14	Generating Software SYNC without	
Generating HBLK Line Alternation	14	External SYNC Signal	33
HORIZONTAL TIMING SEQUENCE EXAMPLE	15	SYNC during Master Mode Operation	34
VERTICAL TIMING GENERATION	16	Power-Up and Synchronization in Slave Mode	34
Vertical Pattern Groups (VPAT)	17	STANDBY MODE OPERATION	34
Vertical Sequences (VSEQ)	18	CIRCUIT LAYOUT INFORMATION	36
Complete Field: Combining V-Sequences	19	SERIAL INTERFACE TIMING	37
Generating Line Alternation for V-Sequence and HBLK	20	Register Address Banks 1 and 2	38
Second V-Pattern Group during VSG Active Line	20	Updating of New Register Values	39
Sweep Mode Operation	21	COMPLETE LISTING OF REGISTER BANK 1	40
Multiplier Mode	21	COMPLETE LISTING OF REGISTER BANK 2	43
Vertical Sensor Gate (Shift Gate) Patterns	22	OUTLINE DIMENSIONS	59
MODE Register	23		

AD9995—SPECIFICATIONS

Parameter	Min	Typ	Max	Unit
TEMPERATURE RANGE				
Operating	-20		+85	°C
Storage	-65		+150	°C
POWER SUPPLY VOLTAGE				
AVDD (AFE Analog Supply)	2.7	3.0	3.6	V
TCVDD (Timing Core Analog Supply)	2.7	3.0	3.6	V
RGVDD (RG Driver)	2.7	3.0	3.6	V
HVDD (H1–H4 Drivers)	2.7	3.0	3.6	V
DRVDD (Data Output Drivers)	2.7	3.0	3.6	V
DVDD (Digital)	2.7	3.0	3.6	V
POWER DISSIPATION (See TPC 1 for Power Curves)				
36 MHz, Typ Supply Levels, 100 pF H1–H4 Loading		360		mW
Power from HVDD Only*		130		mW
Standby 1 Mode		130		mW
Standby 2 Mode		12		mW
Standby 3 Mode		0.5		mW
MAXIMUM CLOCK RATE (CLI)				
	36			MHz

*The total power dissipated by the HVDD supply may be approximated using the equation

$$Total\ HVDD\ Power = [C_{LOAD} \times HVDD \times Pixel\ Frequency] \times HVDD \times Number\ of\ H\text{-}outputs\ used$$

Reducing the H-loading, using only two of the outputs, and/or using a lower HVDD supply will reduce the power dissipation.

Specifications subject to change without notice.

DIGITAL SPECIFICATIONS

Parameter	Symbol	Min	Typ	Max	Unit
LOGIC INPUTS					
High Level Input Voltage	V_{IH}	2.1			V
Low Level Input Voltage	V_{IL}			0.6	V
High Level Input Current	I_{IH}		10		μA
Low Level Input Current	I_{IL}		10		μA
Input Capacitance	C_{IN}		10		pF
LOGIC OUTPUTS (Except H and RG)					
High Level Output Voltage @ $I_{OH} = 2\text{ mA}$	V_{OH}	2.2			V
Low Level Output Voltage @ $I_{OL} = 2\text{ mA}$	V_{OL}			0.5	V
RG and H-DRIVER OUTPUTS (H1–H4)					
High Level Output Voltage @ Max Current	V_{OH}	VDD – 0.5			V
Low Level Output Voltage @ Max Current	V_{OL}			0.5	V
Maximum Output Current (Programmable)		30			mA
Maximum Load Capacitance (For Each Output)		100			pF

Specifications subject to change without notice.

AD9995

ANALOG SPECIFICATIONS (AVDD = 3.0 V, f_{CLI} = 36 MHz, Typical Timing Specifications, T_{MIN} to T_{MAX}, unless otherwise noted.)

Parameter	Min	Typ	Max	Unit	Notes
CDS*					
Allowable CCD Reset Transient		500		mV	
Max Input Range before Saturation	1.0			V p-p	
Max CCD Black Pixel Amplitude		±50		mV	
VARIABLE GAIN AMPLIFIER (VGA)					
Gain Control Resolution		1024		Steps	
Gain Monotonicity		Guaranteed			
Gain Range					
Min Gain (VGA Code 0)		6		dB	
Max Gain (VGA Code 1023)		42		dB	
BLACK LEVEL CLAMP					
Clamp Level Resolution		256		Steps	Measured at ADC output.
Clamp Level					
Min Clamp Level (Code 0)		0		LSB	
Max Clamp Level (Code 255)		255		LSB	
A/D CONVERTER					
Resolution	12			Bits	
Differential Nonlinearity (DNL)	-1.0	±0.5	+1.0	LSB	
No Missing Codes		Guaranteed			
Full-Scale Input Voltage		2.0		V	
VOLTAGE REFERENCE					
Reference Top Voltage (REFT)		2.0		V	
Reference Bottom Voltage (REFB)		1.0		V	
SYSTEM PERFORMANCE					Includes entire signal chain.
Gain Accuracy					
Low Gain (VGA Code 0)	5.0	5.5	6.0	dB	Gain = (0.0351 × Code) + 6 dB
Max Gain (VGA Code 1023)	40.5	41.5	42.5	dB	
Peak Nonlinearity, 500 mV Input Signal		0.2		%	12 dB gain applied.
Total Output Noise		0.8		LSB rms	AC grounded input, 6 dB gain applied.
Power Supply Rejection (PSR)		50		dB	Measured with step change on supply.

*Input signal characteristics defined as follows:

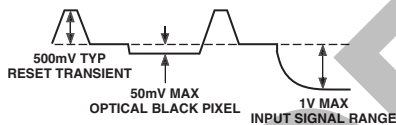

Specifications subject to change without notice.

TIMING SPECIFICATIONS (C_L = 20 pF, AVDD = DVDD = DRVDD = 3.0 V, f_{CLI} = 36 MHz, unless otherwise noted.)

Parameter	Symbol	Min	Typ	Max	Unit
MASTER CLOCK, CLI (Figure 4)					
CLI Clock Period	t _{CONV}	27.8			ns
CLI High/Low Pulsewidth		11.2	13.9	16.6	ns
Delay from CLI Rising Edge to Internal Pixel Position 0	t _{CLIDL}		6		ns
AFE CLPOB Pulsewidth ^{1,2} (Figures 9 and 14)		2	20		Pixels
AFE SAMPLE LOCATION ¹ (Figure 7)					
SHP Sample Edge to SHD Sample Edge	t _{S1}	12.5	13.9		ns
DATA OUTPUTS (Figures 8a and 8b)					
Output Delay from DCLK Rising Edge ¹	t _{OD}		8		ns
Pipeline Delay from SHP/SHD Sampling to DOUT			11		Cycles
SERIAL INTERFACE (Figures 40a and 40b)					
Maximum SCK Frequency	f _{SCLK}	10			MHz
SL to SCK Setup Time	t _{LS}	10			ns
SCK to SL Hold Time	t _{LH}	10			ns
SDATA Valid to SCK Rising Edge Setup	t _{DS}	10			ns
SCK Falling Edge to SDATA Valid Hold	t _{DH}	10			ns
SCK Falling Edge to SDATA Valid Read	t _{DV}	10			ns

NOTES

¹Parameter is programmable.²Minimum CLPOB pulsewidth is for functional operation only. Wider typical pulses are recommended to achieve good clamp performance.

Specifications subject to change without notice.

ABSOLUTE MAXIMUM RATINGS*

Parameter	With Respect To	Min Max		Unit
		Min	Max	
AVDD	AVSS	-0.3	+3.9	V
TCVDD	TCVSS	-0.3	+3.9	V
HVDD	HVSS	-0.3	+3.9	V
RGVDD	RGVSS	-0.3	+3.9	V
DVDD	DVSS	-0.3	+3.9	V
DRVDD	DRVSS	-0.3	+3.9	V
RG Output	RGVSS	-0.3	RGVDD + 0.3	V
H1-H4 Output	HVSS	-0.3	HVDD + 0.3	V
Digital Outputs	DVSS	-0.3	DVDD + 0.3	V
Digital Inputs	DVSS	-0.3	DVDD + 0.3	V
SCK, SL, SDATA	DVSS	-0.3	DVDD + 0.3	V
REFT, REFB, CCDIN	AVSS	-0.3	AVDD + 0.3	V
Junction Temperature			150	°C
Lead Temperature, 10 sec			350	°C

*Stresses above those listed under Absolute Maximum Ratings may cause permanent damage to the device. This is a stress rating only. Functional operation of the device at these or any other conditions above those listed in the operational sections of this specification is not implied. Exposure to absolute maximum rating conditions for extended periods may affect device reliability. Absolute maximum ratings apply individually only, not in combination. Unless otherwise specified, all other voltages are referenced to GND.

CAUTION

ESD (electrostatic discharge) sensitive device. Electrostatic charges as high as 4000V readily accumulate on the human body and test equipment and can discharge without detection. Although the AD9995 features proprietary ESD protection circuitry, permanent damage may occur on devices subjected to high energy electrostatic discharges. Therefore, proper ESD precautions are recommended to avoid performance degradation or loss of functionality.

PACKAGE THERMAL CHARACTERISTICS

Thermal Resistance

$$\theta_{JA} = 25^{\circ}\text{C}/\text{W}^*$$

* θ_{JA} is measured using a 4-layer PCB with the exposed paddle soldered to the board.

ORDERING GUIDE

Model	Temperature Range	Package Description	Package Option
AD9995KCP	-20°C to +85°C	LFCSP	CP-56
AD9995KCPRL	-20°C to +85°C	LFCSP	CP-56



PIN CONFIGURATION

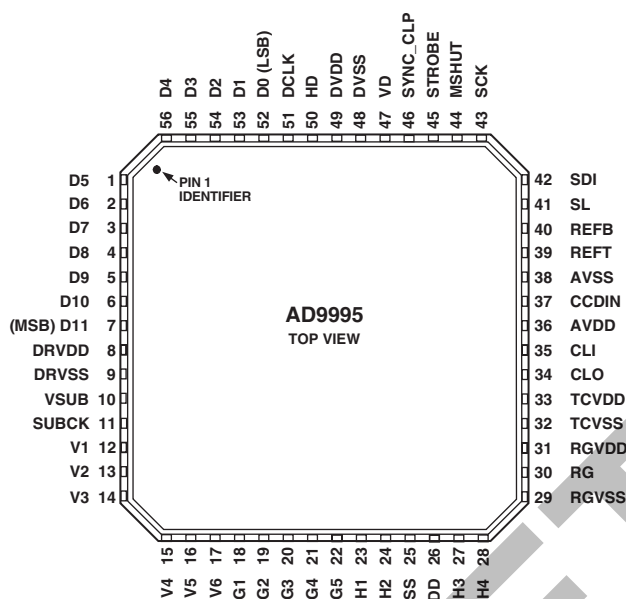

PIN FUNCTION DESCRIPTIONS¹

Pin	Mnemonic	Type ²	Description	Pin	Mnemonic	Type ²	Description
1	D5	DO	Data Output	36	AVDD	P	Analog Supply for AFE
2	D6	DO	Data Output	37	CCDIN	AI	CCD Signal Input
3	D7	DO	Data Output	38	AVSS	P	Analog Ground for AFE
4	D8	DO	Data Output	39	REFT	AO	Voltage Reference Top Bypass
5	D9	DO	Data Output	40	REFB	AO	Voltage Reference Bottom Bypass
6	D10	DO	Data Output	41	SL	DI	3-Wire Serial Load Pulse
7	D11	DO	Data Output (MSB)	42	SDI	DI	3-Wire Serial Data Input
8	DRVDD	P	Data Output Driver Supply	43	SCK	DI	3-Wire Serial Clock
9	DRVSS	P	Data Output Driver Ground	44	MSHUT	DO	Mechanical Shutter Pulse
10	VSUB	DO	CCD Substrate Bias	45	STROBE	DO	Strobe Pulse
11	SUBCK	DO	CCD Substrate Clock (E-Shutter)	46	SYNC	DI	External System Sync Input
12	V1	DO	CCD Vertical Transfer Clock 1	47	VD	DIO	Vertical Sync Pulse (Input for Slave Mode, Output for Master Mode)
13	V2	DO	CCD Vertical Transfer Clock 2	48	DVSS	P	Digital Ground
14	V3	DO	CCD Vertical Transfer Clock 3	49	DVDD	P	Power Supply for VSG, V1–V6, HD/VD, MSHUT, STROBE, SYNC, and Serial Interface
15	V4	DO	CCD Vertical Transfer Clock 4	50	HD	DIO	Horizontal Sync Pulse (Input for Slave Mode, Output for Master Mode)
16	V5	DO	CCD Vertical Transfer Clock 5	51	DCLK	DO	Data Clock Output
17	V6	DO	CCD Vertical Transfer Clock 6	52	D0	DO	Data Output (LSB)
18	VSG1	DO	CCD Sensor Gate Pulse 1	53	D1	DO	Data Output
19	VSG2	DO	CCD Sensor Gate Pulse 2	54	D2	DO	Data Output
20	VSG3	DO	CCD Sensor Gate Pulse 3	55	D3	DO	Data Output
21	VSG4	DO	CCD Sensor Gate Pulse 4	56	D4	DO	Data Output
22	VSG5	DO	CCD Sensor Gate Pulse 5				
23	H1	DO	CCD Horizontal Clock 1				
24	H2	DO	CCD Horizontal Clock 2				
25	HVSS	P	H1–H4 Driver Ground				
26	HVDD	P	H1–H4 Driver Supply				
27	H3	DO	CCD Horizontal Clock 3				
28	H4	DO	CCD Horizontal Clock 4				
29	RGVSS	P	RG Driver Ground				
30	RG	DO	CCD Reset Gate Clock				
31	RGVDD	P	RG Driver Supply				
32	TCVSS	P	Analog Ground for Timing Core				
33	TCVDD	P	Analog Supply for Timing Core				
34	CLO	DO	Clock Output for Crystal				
35	CLI	DI	Reference Clock Input				

NOTES

¹See Figure 38 for circuit configuration.

²AI = Analog Input, AO = Analog Output, DI = Digital Input, DO = Digital Output, DIO = Digital Input/Output, P = Power.

TERMINOLOGY

Differential Nonlinearity (DNL)

An ideal ADC exhibits code transitions that are exactly 1 LSB apart. DNL is the deviation from this ideal value. Therefore, every code must have a finite width. No missing codes guaranteed to 12-bit resolution indicates that all 4096 codes must be present over all operating conditions.

Peak Nonlinearity

Peak nonlinearity, a full signal chain specification, refers to the peak deviation of the output of the AD9995 from a true straight line. The point used as zero scale occurs 0.5 LSB before the first code transition. Positive full scale is defined as a level 1.5 LSB beyond the last code transition. The deviation is measured from the middle of each particular output code to the true straight line. The error is then expressed as a percent-

age of the 2 V ADC full-scale signal. The input signal is always appropriately gained up to fill the ADC's full-scale range.

Total Output Noise

The rms output noise is measured using histogram techniques. The standard deviation of the ADC output codes is calculated in LSB and represents the rms noise level of the total signal chain at the specified gain setting. The output noise can be converted to an equivalent voltage using the relationship $1 \text{ LSB} = (\text{ADC Full Scale}/2^n \text{ codes})$, where n is the bit resolution of the ADC. For the AD9995, 1 LSB is 0.488 mV.

Power Supply Rejection (PSR)

The PSR is measured with a step change applied to the supply pins. The PSR specification is calculated from the change in the data outputs for a given step change in the supply voltage.

EQUIVALENT CIRCUITS

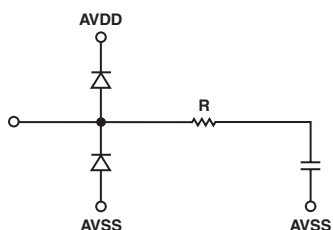

Circuit 1. CCDIN

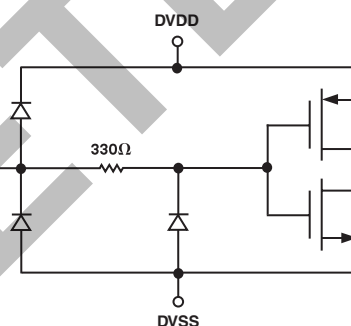

Circuit 3. Digital Inputs

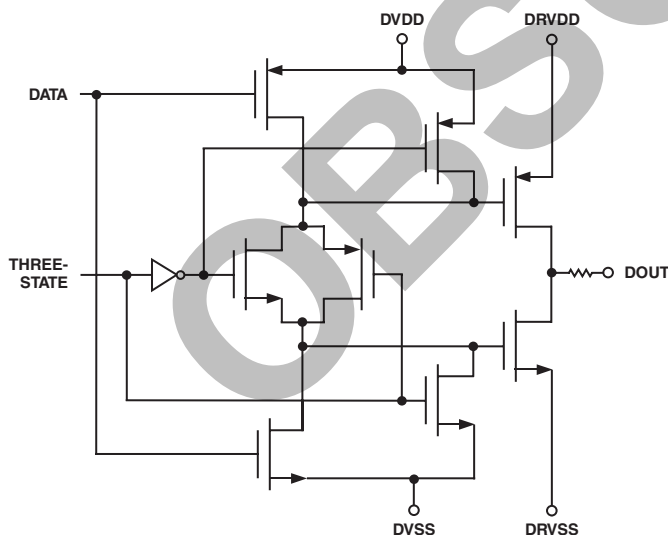

Circuit 2. Digital Data Outputs

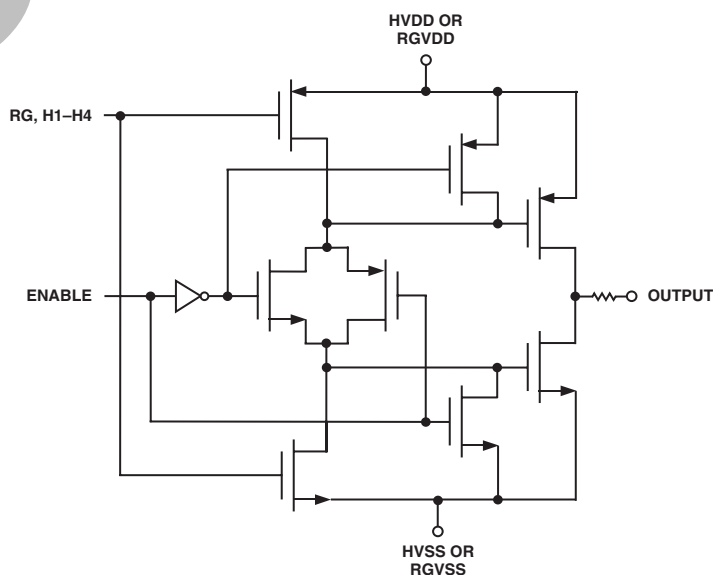

Circuit 4. H1-H4, RG Drivers

AD9995—Typical Performance Characteristics

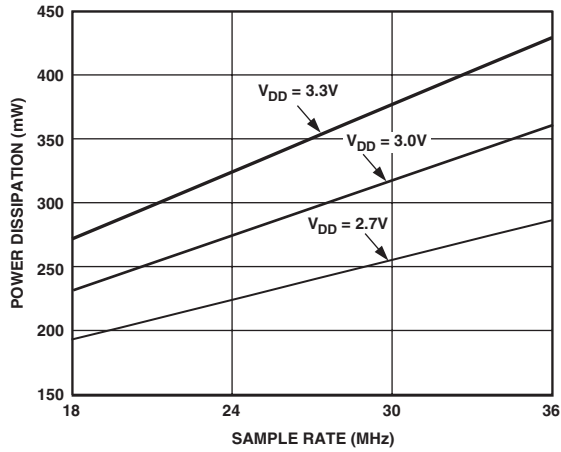

TPC 1. Power Dissipation vs. Sample Rate

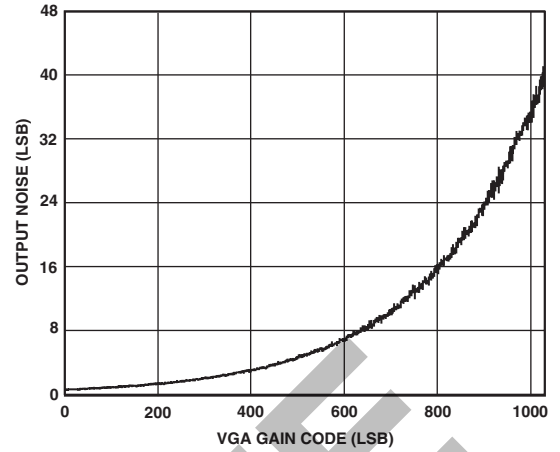

TPC 3. Output Noise vs. VGA Gain

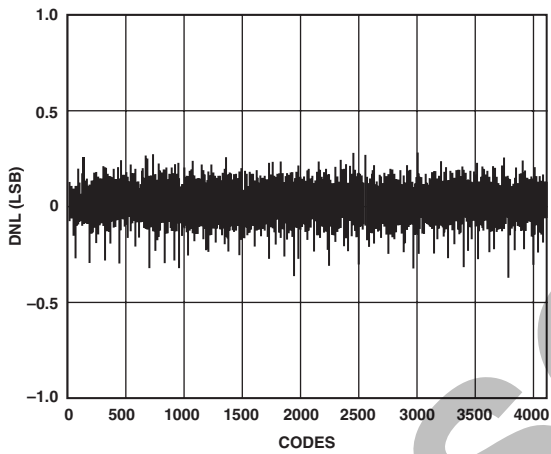

TPC 2. Typical DNL Performance

SYSTEM OVERVIEW

Figure 1 shows the typical system block diagram for the AD9995 used in Master mode. The CCD output is processed by the AD9995's AFE circuitry, which consists of a CDS, VGA, black level clamp, and A/D converter. The digitized pixel information is sent to the digital image processor chip, which performs the postprocessing and compression. To operate the CCD, all CCD timing parameters are programmed into the AD9995 from the system microprocessor through the 3-wire serial interface. From the system master clock, CLI, provided by the image processor or external crystal, the AD9995 generates all of the CCD's horizontal and vertical clocks and all internal AFE clocks. External synchronization is provided by a SYNC pulse from the microprocessor, which will reset internal counters and resync the VD and HD outputs.

Alternatively, the AD9995 may be operated in Slave mode, in which VD and HD are provided externally from the image processor. In this mode, all AD9995 timing will be synchronized with VD and HD.

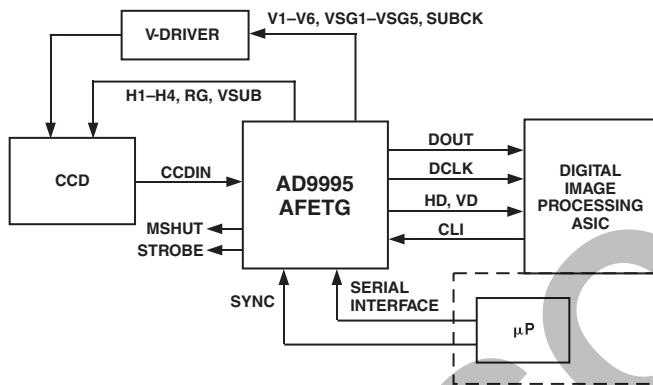

Figure 1. Typical System Block Diagram, Master Mode

The H-drivers for H1-H4 and RG are included in the AD9995, allowing these clocks to be directly connected to the CCD. H-drive voltage of up to 3.3 V is supported. An external V-driver is required for the vertical transfer clocks, the sensor gate pulses, and the substrate clock.

The AD9995 also includes programmable MSHUT and STROBE outputs, which may be used to trigger mechanical shutter and strobe (flash) circuitry.

Figures 2 and 3 show the maximum horizontal and vertical counter dimensions for the AD9995. All internal horizontal and vertical clocking is controlled by these counters to specify line and pixel locations. Maximum HD length is 4095 pixels per line, and maximum VD length is 4095 lines per field.

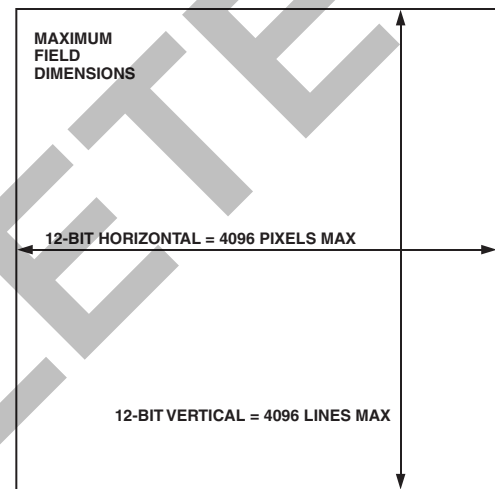

Figure 2. Vertical and Horizontal Counters

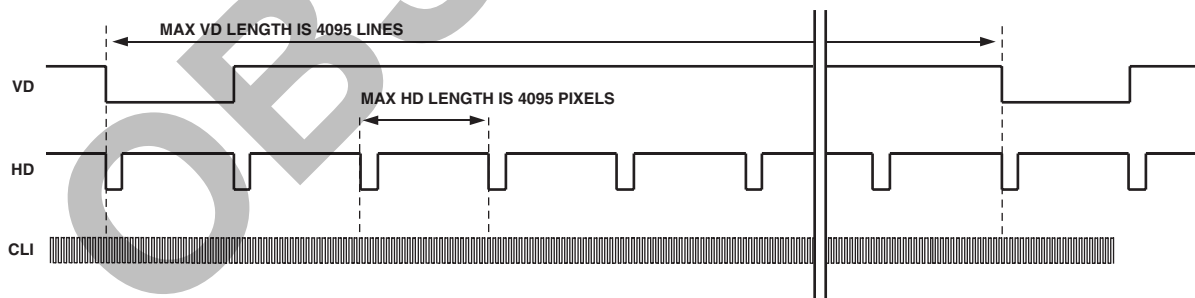

Figure 3. Maximum VD/HD Dimensions

AD9995

PRECISION TIMING HIGH SPEED TIMING GENERATION

The AD9995 generates high speed timing signals using the flexible Precision Timing core. This core is the foundation for generating the timing used for both the CCD and the AFE: the reset gate RG, horizontal drivers H1–H4, and SHP/SHD sample clocks. A unique architecture makes it routine for the system designer to optimize image quality by providing precise control over the horizontal CCD readout and the AFE correlated double sampling.

The high speed timing of the AD9995 operates the same in either Master or Slave mode configuration. For more information on synchronization and pipeline delays, see the Power-Up and Synchronization section.

Timing Resolution

The Precision Timing core uses a 1× master clock input (CLI) as a reference. This clock should be the same as the CCD pixel clock frequency. Figure 4 illustrates how the internal timing core divides the master clock period into 48 steps or edge positions. Using a 20 MHz CLI frequency, the edge resolution of the Precision Timing core is 1 ns. If a 1× system clock is not available, it is also possible to use a 2× reference clock by programming the

CLIDIVIDE register (Addr. 0x30). The AD9995 will then internally divide the CLI frequency by 2.

The AD9995 also includes a master clock output, CLO, which is the inverse of CLI. This output is intended to be used as a crystal driver. A crystal can be placed between the CLI and CLO pins to generate the master clock for the AD9995. For more information on using a crystal, see Figure 39.

High Speed Clock Programmability

Figure 5 shows how the high speed clocks RG, H1–H4, SHP, and SHD are generated. The RG pulse has programmable rising and falling edges, and may be inverted using the polarity control. The horizontal clocks H1 and H3 have programmable rising and falling edges and polarity control. The H2 and H4 clocks are always inverses of H1 and H3, respectively. Table I summarizes the high speed timing registers and their parameters. Figure 6 shows the typical 2-phase H-clock arrangement in which H3 and H4 are programmed for the same edge location as H1 and H2.

The edge location registers are 6 bits wide, but there are only 48 valid edge locations available. Therefore, the register values are

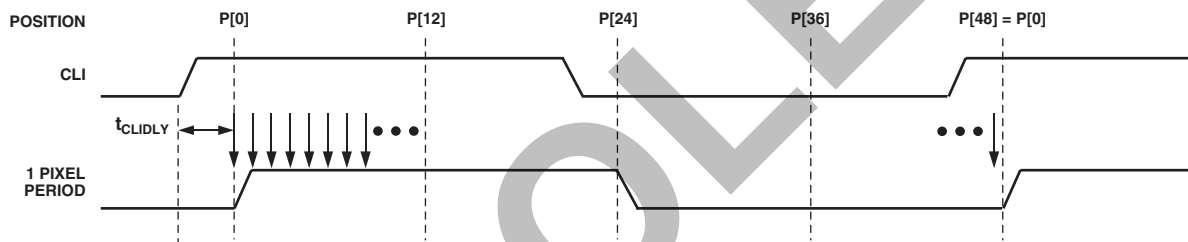

NOTES
PIXEL CLOCK PERIOD IS DIVIDED INTO 48 POSITIONS, PROVIDING FINE EDGE RESOLUTION FOR HIGH SPEED CLOCKS.
THERE IS A FIXED DELAY FROM THE CLI INPUT TO THE INTERNAL PIXEL PERIOD POSITIONS ($t_{CLIDLAY} = 6\text{ns TYP}$).

Figure 4. High Speed Clock Resolution from CLI Master Clock Input

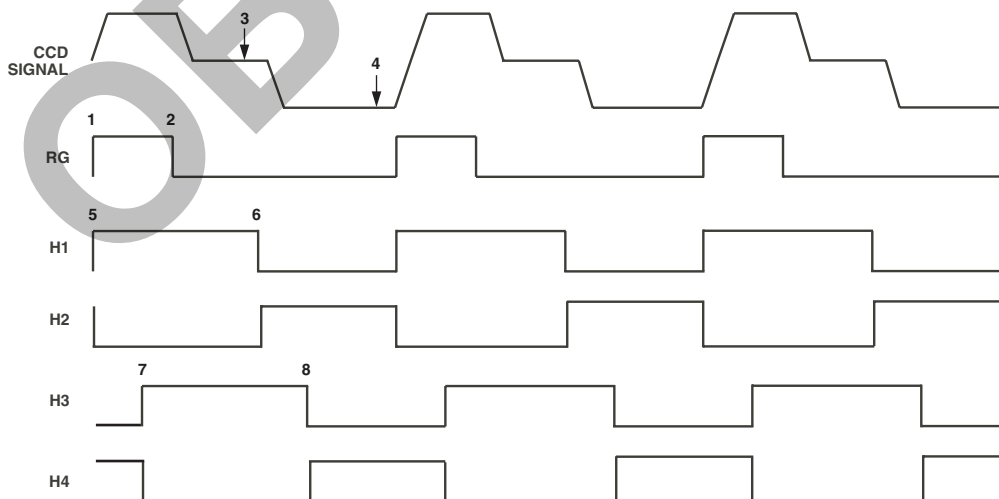

PROGRAMMABLE CLOCK POSITIONS:
1. RG RISING EDGE
2. RG FALLING EDGE
3. SHP SAMPLE LOCATION
4. SHD SAMPLE LOCATION
5. H1 RISING EDGE POSITION
6. H1 FALLING EDGE POSITION (H2 IS INVERSE OF H1)
7. H3 RISING EDGE POSITION
8. H3 FALLING EDGE POSITION (H4 IS INVERSE OF H3)

Figure 5. High Speed Clock Programmable Locations

mapped into four quadrants, with each quadrant containing 12 edge locations. Table II shows the correct register values for the corresponding edge locations.

Figure 7 shows the default timing locations for all of the high speed clock signals.

H-Driver and RG Outputs

In addition to the programmable timing positions, the AD9995 features on-chip output drivers for the RG and H1–H4 outputs. These drivers are powerful enough to directly drive the CCD inputs. The H-driver and RG current can be adjusted for optimum rise/fall time into a particular load by using the DRVCONTROL register (Addr. 0x35). The 3-bit drive setting for each output is adjustable in 4.1 mA increments, with the minimum setting of 0 equal to OFF or three-state, and the maximum setting of 7 equal to 30.1 mA.

As shown in Figures 5, 6, and 7, the H2 and H4 outputs are inverses of H1 and H3, respectively. The H1/H2 crossover voltage is approximately 50% of the output swing. The crossover voltage is not programmable.

Digital Data Outputs

The AD9995 data output and DCLK phases are programmable using the DOUTPHASE register (Addr. 0x37, Bits [5:0]). Any edge from 0 to 47 may be programmed, as shown in Figure 8a. Normally, the DOUT and DCLK signals will track in phase based on the DOUTPHASE register contents. The DCLK output phase can also be held fixed with respect to the data outputs by changing the DCLKMODE register high (Addr. 0x37, Bit 6). In this mode, the DCLK output will remain at a fixed phase equal to CLO (the inverse of CLI) while the data output phase is still programmable.

There is a fixed output delay from the DCLK rising edge to the DOUT transition, called t_{OD} . This delay can be programmed to four values between 0 ns and 12 ns by using the DOUTDELAY register (Addr. 0x037, Bits [8:7]). The default value is 8 ns.

The pipeline delay through the AD9995 is shown in Figure 8b. After the CCD input is sampled by SHD, there is an 11-cycle delay until the data is available.

Table I. Timing Core Register Parameters for H1, H3, RG, SHP/SHD

Parameter	Length	Range	Description
Polarity	1b	High/Low	Polarity Control for H1, H3, and RG (0 = No Inversion, 1 = Inversion)
Positive Edge	6b	0–47 Edge Location	Positive Edge Location for H1, H3, and RG
Negative Edge	6b	0–47 Edge Location	Negative Edge Location for H1, H3, and RG
Sampling Location	6b	0–47 Edge Location	Sampling Location for Internal SHP and SHD Signals
Drive Strength	3b	0–47 Current Steps	Drive Current for H1–H4 and RG Outputs (4.1 mA per Step)

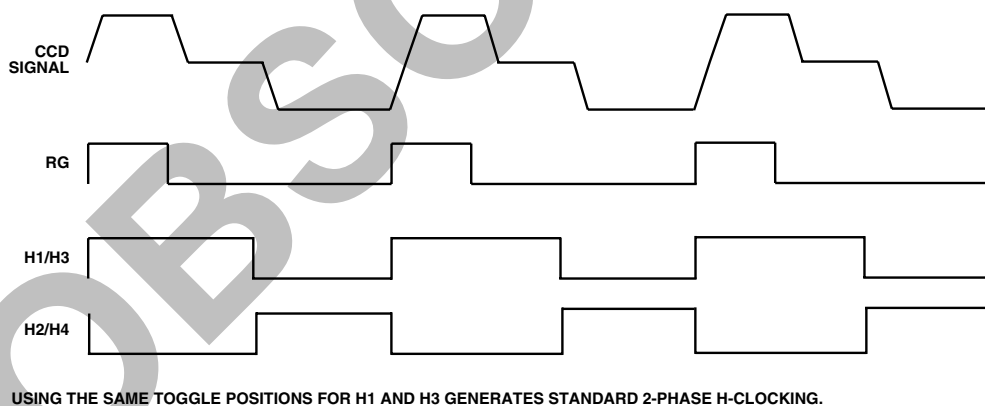

Figure 6. 2-Phase H-Clock Operation

Table II. Precision Timing Edge Locations

Quadrant	Edge Location (Dec)	Register Value (Dec)	Register Value (Bin)
I	0 to 11	0 to 11	000000 to 001011
II	12 to 23	16 to 27	010000 to 011011
III	24 to 35	32 to 43	100000 to 101011
IV	36 to 47	48 to 59	110000 to 111011

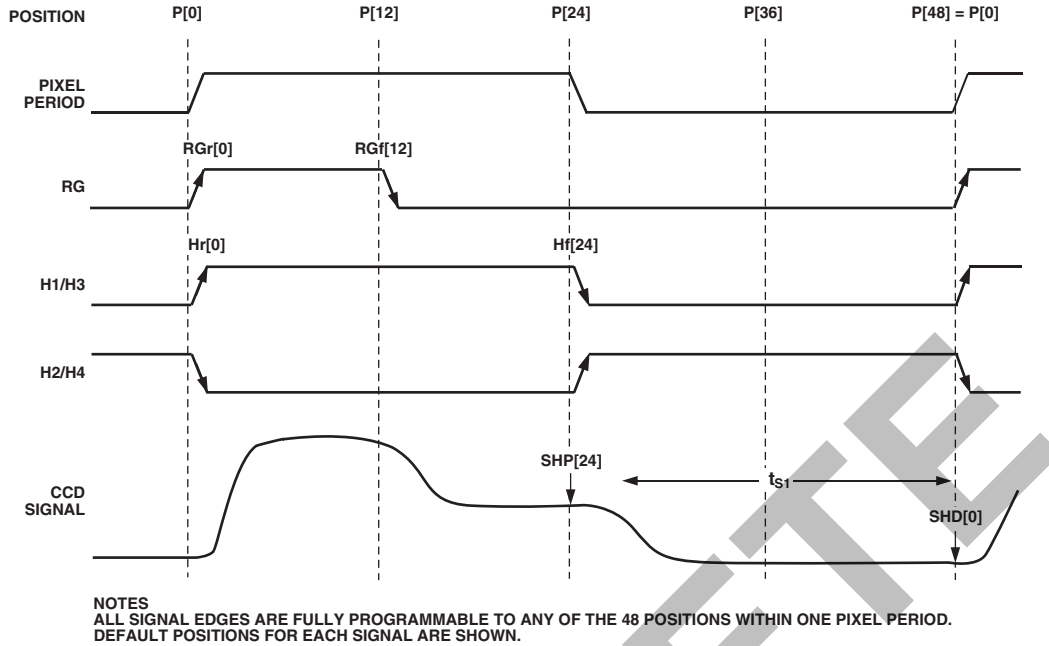

Figure 7. High Speed Timing Default Locations

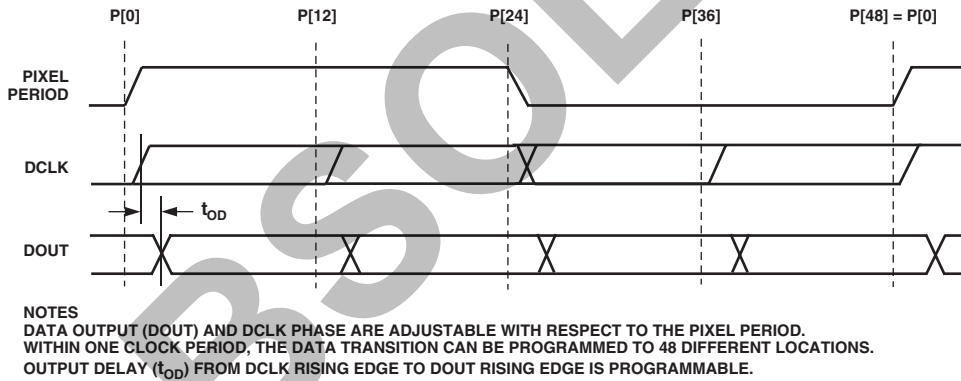

Figure 8a. Digital Output Phase Adjustment

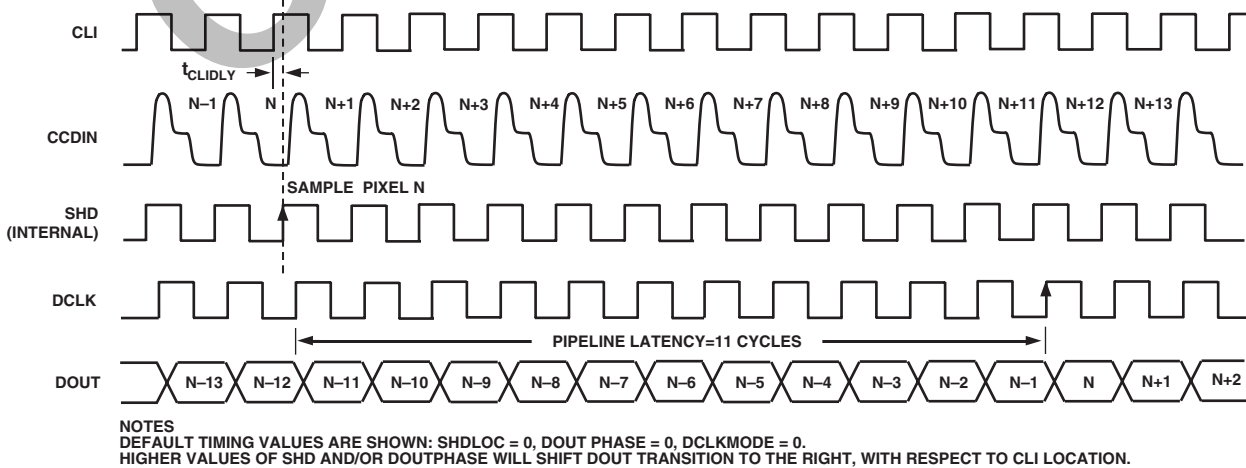

Figure 8b. Pipeline Delay

HORIZONTAL CLAMPING AND BLANKING

The AD9995's horizontal clamping and blanking pulses are fully programmable to suit a variety of applications. Individual control is provided for CLPOB, PBLK, and HBLK during the different regions of each field. This allows the dark pixel clamping and blanking patterns to be changed at each stage of the readout in order to accommodate different image transfer timing and high speed line shifts.

Individual CLPOB and PBLK Patterns

The AFE horizontal timing consists of CLPOB and PBLK, as shown in Figure 9. These two signals are independently programmed using the registers in Table III. SPOL is the start polarity for the signal, and TOG1 and TOG2 are the first and second toggle positions of the pulse. Both signals are active low and should be programmed accordingly.

A separate pattern for CLPOB and PBLK may be programmed for every 10 V-sequences. As described in the Vertical Timing Generation section, up to 10 separate V-sequences can be created,

each containing a unique pulse pattern for CLPOB and PBLK. Figure 9 shows how the sequence change positions divide the readout field into different regions. A different V-sequence can be assigned to each region, allowing the CLPOB and PBLK signals to be changed accordingly with each change in the vertical timing.

Individual HBLK Patterns

The HBLK programmable timing shown in Figure 10 is similar to CLPOB and PBLK. However, there is no start polarity control. Only the toggle positions are used to designate the start and stop positions of the blanking period. Additionally, there is a polarity control HBLKMASK that designates the polarity of the horizontal clock signals H1–H4 during the blanking period. Setting HBLKMASK high will set H1 = H3 = low and H2 = H4 = high during the blanking, as shown in Figure 11. As with the CLPOB and PBLK signals, HBLK registers are available in each V-sequence, allowing different blanking signals to be used with different vertical timing sequences.

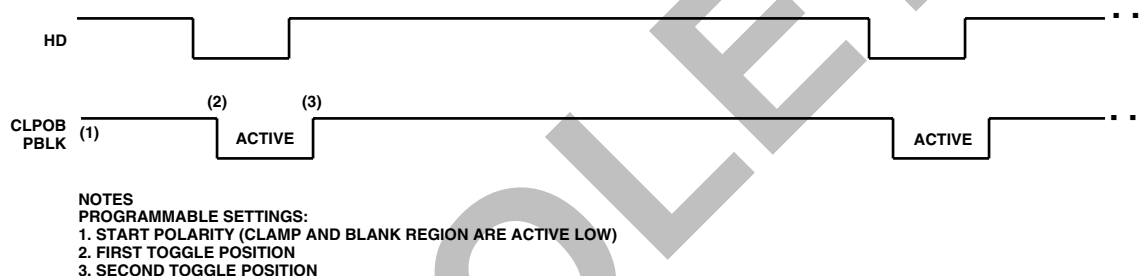

Figure 9. Clamp and Pre-Blank Pulse Placement

Table III. CLPOB and PBLK Pattern Registers

Register	Length	Range	Description
SPOL	1b	High/Low	Starting Polarity of CLPOB/PBLK for V-Sequence 0–9
TOG1	12b	0–4095 Pixel Location	First Toggle Position within Line for V-Sequence 0–9
TOG2	12b	0–4095 Pixel Location	Second Toggle Position within Line for V-Sequence 0–9

Table IV. HBLK Pattern Registers

Register	Length	Range	Description
HBLKMASK	1b	High/Low	Masking Polarity for H1/H3 (0 = H1/H3 Low, 1 = H1/H3 High)
HBLKALT	2b	0–3 Alternation Mode	Enables Odd/Even Alternation of HBLK Toggle Positions 0 = Disable Alternation. 1 = TOG1–TOG2 Odd, TOG3–TOG6 Even. 2 = 3 = TOG1–TOG2 Even, TOG3–TOG6 Odd
HBLKTOG1	12b	0–4095 Pixel Location	First Toggle Position within Line for Each V-Sequence 0–9
HBLKTOG2	12b	0–4095 Pixel Location	Second Toggle Position within Line for Each V-Sequence 0–9
HBLKTOG3	12b	0–4095 Pixel Location	Third Toggle Position within Line for Each V-Sequence 0–9
HBLKTOG4	12b	0–4095 Pixel Location	Fourth Toggle Position within Line for Each V-Sequence 0–9
HBLKTOG5	12b	0–4095 Pixel Location	Fifth Toggle Position within Line for Each V-Sequence 0–9
HBLKTOG6	12b	0–4095 Pixel Location	Sixth Toggle Position within Line for Each V-Sequence 0–9

AD9995

Generating Special HBLK Patterns

There are six toggle positions available for HBLK. Normally, only two of the toggle positions are used to generate the standard HBLK interval. However, the additional toggle positions may be used to generate special HBLK patterns, as shown in Figure 12. The pattern in this example uses all six toggle positions to generate two extra groups of pulses during the HBLK interval. By changing the toggle positions, different patterns can be created.

Generating HBLK Line Alternation

One further feature of the AD9995 is the ability to alternate different HBLK toggle positions on odd and even lines. This may be used in conjunction with V-pattern odd/even alternation or on its own. When a 1 is written to the HBLKALT register, TOG1 and TOG2 are used on odd lines only, while TOG3–TOG6 are used on even lines. Writing a 2 to the HBLKALT register gives the opposite result: TOG1 and TOG2 are used on even lines, while TOG3–TOG6 are used on odd lines. See the Vertical Timing Generation, Line Alternation section for more information.

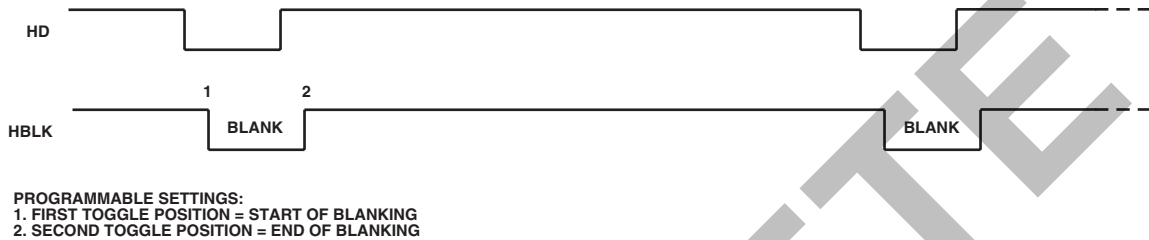

Figure 10. Horizontal Blanking (HBLK) Pulse Placement

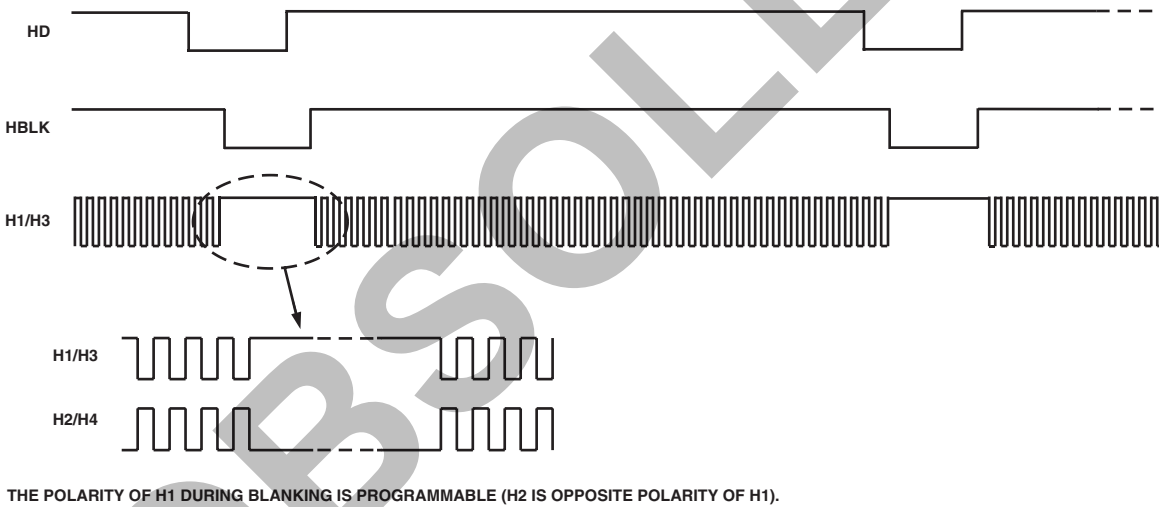

Figure 11. HBLK Masking Control

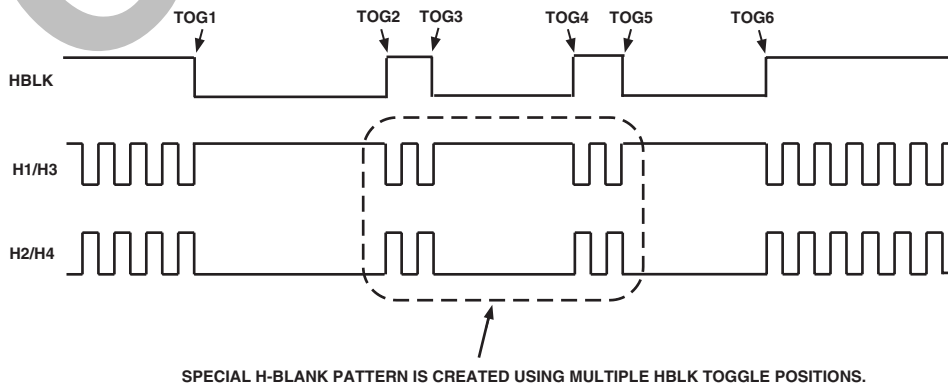

Figure 12. Generating Special HBLK Patterns

HORIZONTAL TIMING SEQUENCE EXAMPLE

Figure 13 shows an example CCD layout. The horizontal register contains 28 dummy pixels, which will occur on each line clocked from the CCD. In the vertical direction, there are 10 optical black (OB) lines at the front of the readout and two at the back of the readout. The horizontal direction has four OB pixels in the front and 48 in the back.

Figure 14 shows the basic sequence layout to be used during the effective pixel readout. The 48 OB pixels at the end of each line are used for the CLPOB signals. PBLK is optional and is often used to blank the digital outputs during the noneffective CCD pixels. HBLK is used during the vertical shift interval.

The HBLK, CLPOB, and PBLK parameters are programmed in the V-sequence registers.

More elaborate clamping schemes may be used, such as adding in a separate sequence to clamp during the entire shield OB lines. This requires configuring a separate V-sequence for reading out the OB lines.

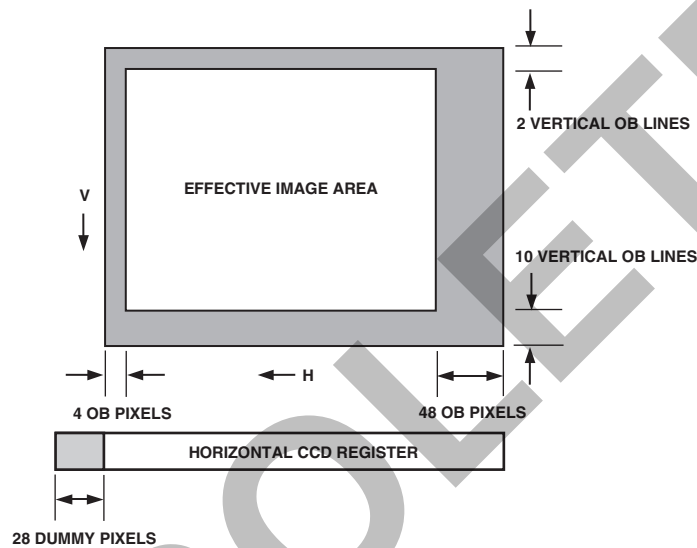

Figure 13. Example CCD Configuration

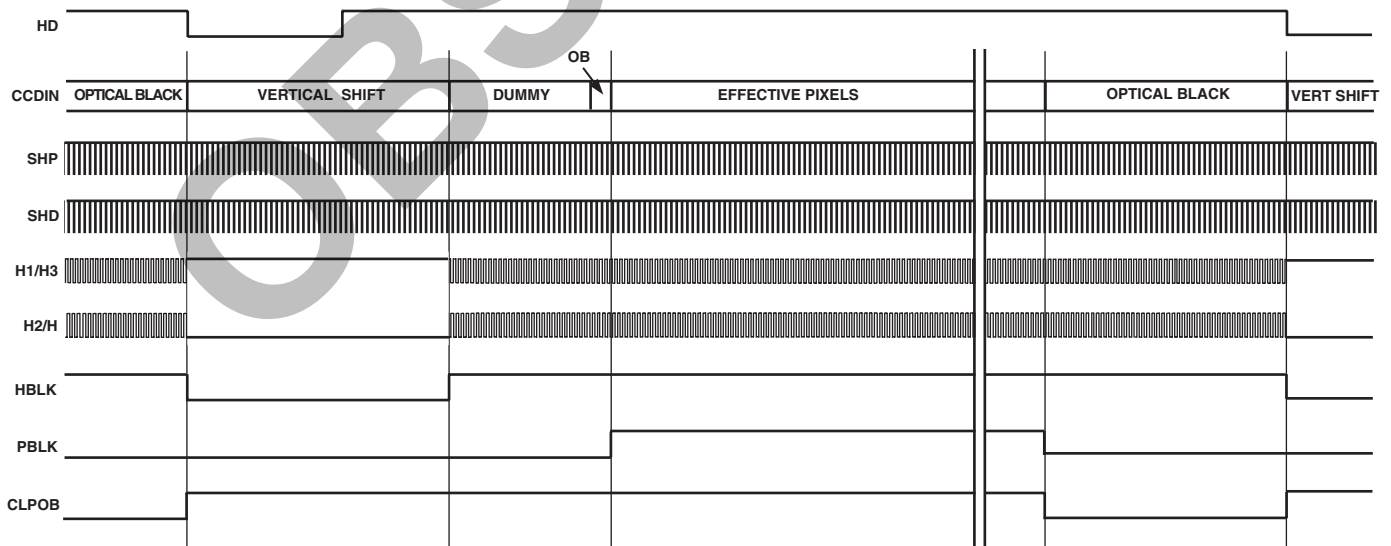

Figure 14. Horizontal Sequence Example

AD9995

VERTICAL TIMING GENERATION

The AD9995 provides a very flexible solution for generating vertical CCD timing, and can support multiple CCDs and different system architectures. The 6-phase vertical transfer clocks V1–V6 are used to shift each line of pixels into the horizontal output register of the CCD. The AD9995 allows these outputs to be individually programmed into various readout configurations using a 4-step process.

Figure 15 shows an overview of how the vertical timing is generated in four steps. First, the individual pulse patterns for V1–V6

are created by using the vertical pattern group registers. Second, the V-pattern groups are used to build the sequences, where additional information is added. Third, the readout for an entire field is constructed by dividing the field into different regions and then assigning a sequence to each region. Each field can contain up to seven different regions to accommodate different steps of the readout such as high speed line shifts and unique vertical line transfers. Up to six different fields may be created. Finally, the Mode register allows the different fields to be combined into any order for various readout configurations.

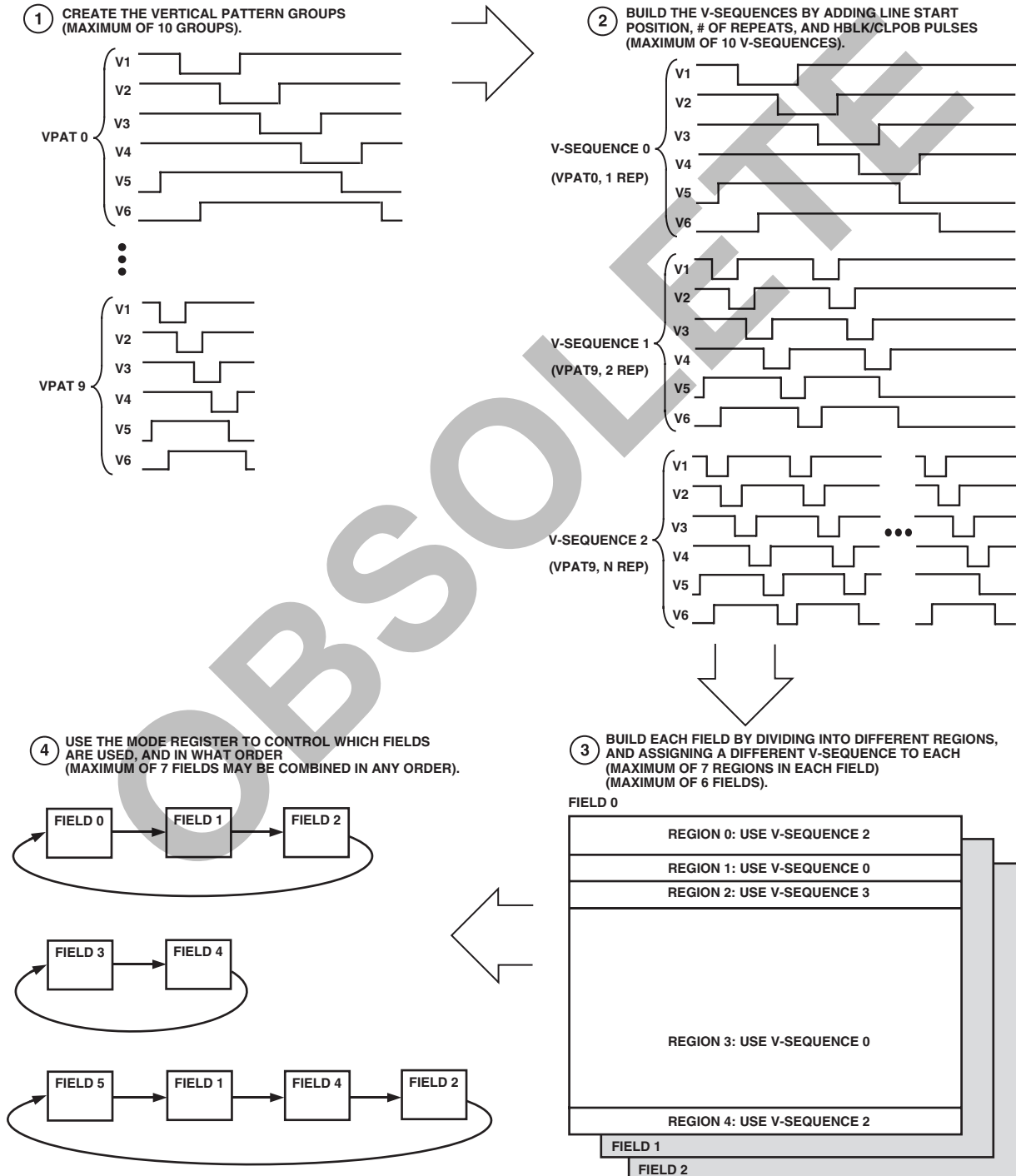

Figure 15. Summary of Vertical Timing Generation

Vertical Pattern Groups (VPAT)

The vertical pattern groups define the individual pulse patterns for each V1–V6 output signal. Table V summarizes the registers available for generating each of the 10 V-pattern groups. The start polarity (VPOL) determines the starting polarity of the vertical sequence, and can be programmed high or low for each V1–V6 output. The first, second, and third toggle position (VTOG1, VTOG2, VTOG3) are the pixel locations within the line where the pulse transitions. A fourth toggle position (VTOG4) is also available for V-Pattern Groups 8 and 9. All toggle positions are 12-bit values, allowing their placement anywhere in the horizontal line. A separate register, VPATSTART, specifies the start position of the V-pattern group within the line (see the Vertical Sequences section). The VPATLEN register designates the total

length of the V-pattern group, which will determine the number of pixels between each of the pattern repetitions, when repetitions are used (see the Vertical Sequences section).

The FREEZE and RESUME registers are used to temporarily stop the operation of the V1–V6 outputs. At the pixel location specified in the FREEZE register, the V1–V6 outputs will be held static at their current dc state, high or low. The V1–V6 outputs are held until the pixel location specified by RESUME register. Two sets of FREEZE/RESUME registers are provided, allowing the vertical outputs to be interrupted twice in the same line. The FREEZE and RESUME positions are programmed in the V-pattern group registers, but are separately enabled using the VMASK registers, which are described in the Vertical Sequence section.

Table V. Vertical Pattern Group Registers

Register	Length	Range	Description
VPOL	1b	High/Low	Starting Polarity of Each V1–V6 Output
VTOG1	12b	0–4096 Pixel Location	First Toggle Position within Line for Each V1–V6 Output
VTOG2	12b	0–4096 Pixel Location	Second Toggle Position within Line for Each V1–V6 Output
VTOG3	12b	0–4096 Pixel Location	Third Toggle Position within Line for Each V1–V6 Output
VTOG4	12b	0–4096 Pixel Location	Fourth Toggle Position, only Available in V-Pattern Groups 8 and 9
VPATLEN	12b	0–4096 Pixels	Total Length of Each V-Pattern Group
FREEZE1	12b	0–4096 Pixel Location	Holds the V1–V6 Outputs at Their Current Levels (Static DC)
RESUME1	12b	0–4096 Pixel Location	Resumes Operation of the V1–V6 Outputs to Finish Their Pattern
FREEZE2	12b	0–4096 Pixel Location	Holds the V1–V6 Outputs at Their Current Levels (Static DC)
RESUME2	12b	0–4096 Pixel Location	Resumes Operation of the V1–V6 Outputs to Finish Their Pattern

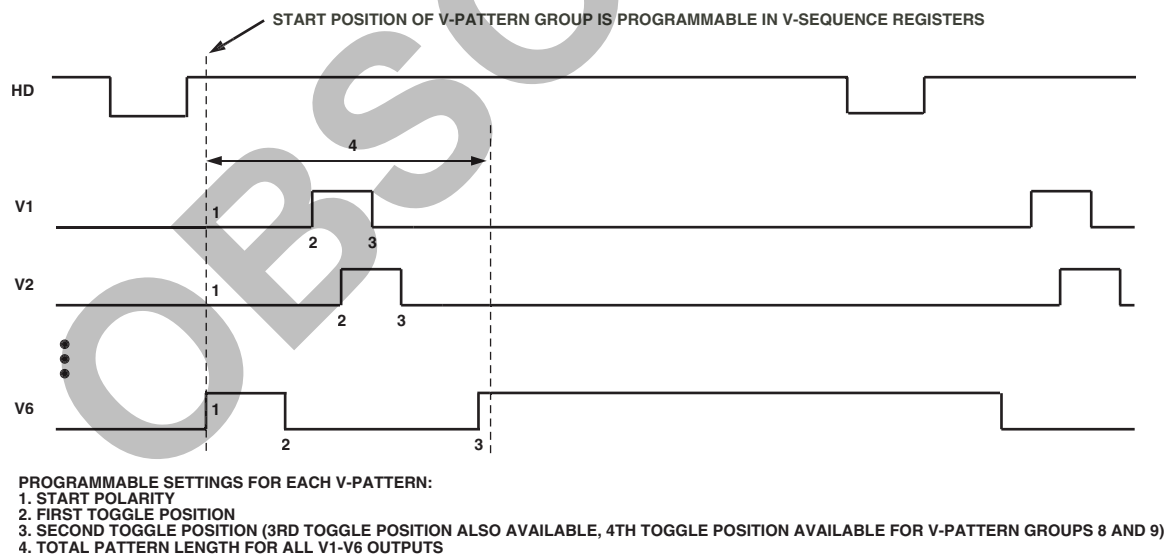

Figure 16. Vertical Pattern Group Programmability

AD9995

Vertical Sequences (VSEQ)

The vertical sequences are created by selecting one of the 10 V-pattern groups and adding repeats, start position, and horizontal clamping and blanking information. Up to 10 V-sequences can be programmed, each using the registers shown in Table VI. Figure 17 shows how the different registers are used to generate each V-sequence.

The VPATSEL register selects which V-pattern group will be used in a given V-sequence. The basic V-pattern group can have repetitions added, for high speed line shifts or line binning, by using the VPATREPO and VPATREPE registers. Generally, the same number of repetitions are programmed into both registers, but if a different number of repetitions is required on odd and

even lines, separate values may be used for each register (see the V-Sequence Line Alternation section). The VPATSTART register specifies where in the line the V-pattern group will start. The VMASK register is used in conjunction with the FREEZE/RESUME registers to enable optional masking of the V-outputs. Either or both of the FREEZE1/RESUME1 and FREEZE2/RESUME2 registers can be enabled.

The line length (in pixels) is programmable using the HDLEN registers. Each V-sequence can have a different line length to accommodate various image readout techniques. The maximum number of pixels per line is 4096. Note that the last line of the field is separately programmable using the HDLAST register located in the Field register section.

Table VI. V-Sequence Registers (see Tables III and IV for HBLK, CLPOB, PBLK Registers)

Register	Length	Range	Description
VPATSEL	4b	0–9 V-Pattern Group #	Selected V-Pattern Group for Each V-Sequence.
VMASK	2b	0–3 Mask Mode	Enables the Masking of V1–V6 Outputs at the Locations Specified by the FREEZE/RESUME Registers. 0 = No Mask, 1 = Enable FREEZE1/RESUME1, 2 = Enable FREEZE2/RESUME2, 3 = Enable both 1 and 2.
VPATREPO	12b	0–4095 # of Repeats	Number of Repetitions for the V-Pattern Group for Odd Lines. If no odd/even alternation is required, set to VPATREPE.
VPATREPE	12b	0–4095 # of Repeats	Number of Repetitions for the V-Pattern Group for Even Lines. If no odd/even alternation is required, set to VPATREPO.
VPATSTART	12b	0–4095 Pixel Location	Start Position for the Selected V-Pattern Group.
HDLEN	12b	0–4095 # of Pixels	HD Line Length for Lines in Each V-Sequence.

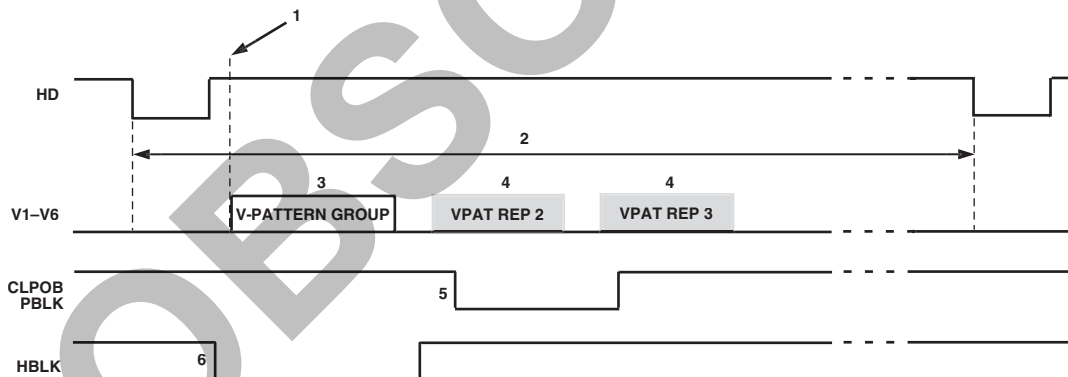

- PROGRAMMABLE SETTINGS FOR EACH V-SEQUENCE:**
1. START POSITION IN THE LINE OF SELECTED V-PATTERN GROUP
 2. HD LINE LENGTH
 3. V-PATTERN SELECT (VPATSEL) TO SELECT ANY V-PATTERN GROUP
 4. NUMBER OF REPETITIONS OF THE V-PATTERN GROUP (IF NEEDED)
 5. START POLARITY AND TOGGLE POSITIONS FOR CLPOB AND PBLK SIGNALS
 6. MASKING POLARITY AND TOGGLE POSITIONS FOR HBLK SIGNAL

Figure 17. V-Sequence Programmability

Complete Field: Combining V-Sequences

After the V-sequences have been created, they are combined to create different readout fields. A field consists of up to seven different regions, and within each region a different V-sequence can be selected. Figure 18 shows how the sequence change positions (SCP) designate the line boundary for each region, and the VSEQSEL registers then select which V-sequence is used during each region. Registers to control the VSG outputs are also included in the Field registers.

Table VII summarizes the registers used to create the different fields. Up to six different fields can be preprogrammed using all of the Field registers.

The VEQSEL registers, one for each region, select which of the 10 V-sequences will be active during each region. The SWEEP registers are used to enable SWEEP mode during any region. The MULTI registers are used to enable Multiplier mode dur-

ing any region. The SCP registers create the line boundaries for each region. The VDLEN register specifies the total number of lines in the field. The total number of pixels per line (HDLEN) is specified in the V-sequence registers, but the HDLAST register specifies the number of pixels in the last line of the field. The VPATSECOND register is used to add a second V-pattern group to the V1–6 outputs during the sensor gate (VSG) line.

The SGMASK register is used to enable or disable each individual VSG output. There is a single bit for each VSG output; setting the bit high will mask the output, setting it low will enable the output. The SGPAT register assigns one of the four different SG patterns to each VSG output. The individual SG patterns are created separately using the SG pattern registers. The SGLINE1 register specifies which line in the field will contain the VSG outputs. The optional SGLINE2 register allows the same VSG pulses to be repeated on a different line.

Table VII. Field Registers

Register	Length	Range	Description
VSEQSEL	4b	0–9 V-Sequence #	Selected V-Sequence for Each Region in the Field.
SWEEP	1b	High/Low	Enables Sweep Mode for Each Region, When Set High.
MULTI	1b	High/Low	Enables Multiplier Mode for Each Region, When Set High.
SCP	12b	0–4095 Line #	Sequence Change Position for Each Region.
VDLEN	12b	0–4095 # of Lines	Total Number of Lines in Each Field.
HDLAST	12b	0–4095 # of Pixels	Length in Pixels of the Last HD Line in Each Field.
VPATSECOND	4b	0–9 V-Pattern Group #	Selected V-Pattern Group for Second Pattern Applied During VSG Line.
SGMASK	6b	High/Low, Each VSG	Set High to Mask Each Individual VSG Output. VSG1 [0], VSG2 [1], VSG3 [2], VSG4 [3], VSG5 [4].
SGPATSEL	12b	0–3 Pattern #, Each VSG	Selects the VSG Pattern Number for Each VSG Output. VSG1 [1:0], VSG2 [3:2], VSG3 [5:4], VSG4 [7:6], VSG5 [9:8].
SGLINE1	12b	0–4095 Line #	Selects the Line in the Field where the VSG Are Active.
SGLINE2	12b	0–4095 Line #	Selects a Second Line in the Field to Repeat the VSG Signals.

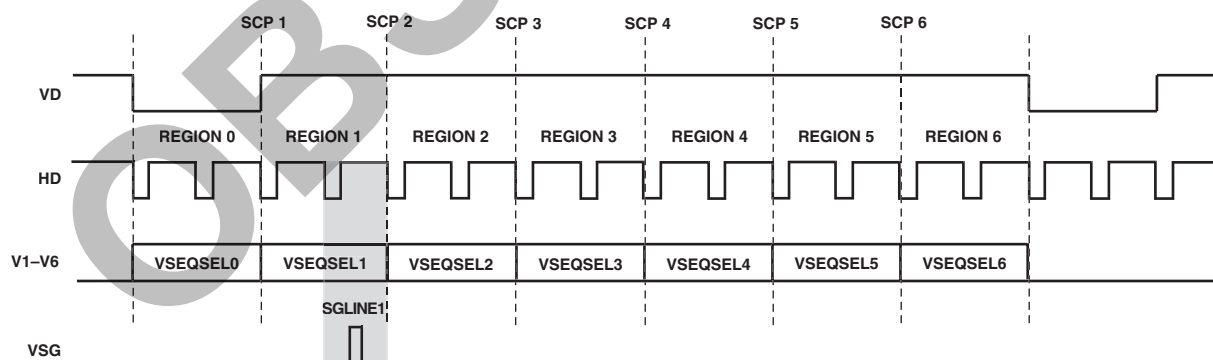

- FIELD SETTINGS:
1. SEQUENCE CHANGE POSITIONS (SCP1–6) DEFINE EACH OF THE 7 REGIONS IN THE FIELD.
 2. VSEQSEL0–6 SELECTS THE DESIRED V-SEQUENCE (0–9) FOR EACH REGION.
 3. SGLINE1 REGISTER SELECTS WHICH HD LINE IN THE FIELD WILL CONTAIN THE SENSOR GATE PULSE(S).

Figure 18. Complete Field Is Divided into Regions

AD9995

Generating Line Alternation for V-Sequence and HBLK

During low resolution readout, some CCDs require a different number of vertical clocks on alternate lines. The AD9995 can support this by using the VPATREPO and VPATREPE registers. This allows a different number of VPAT repetitions to be programmed on odd and even lines. Note that only the number of repeats can be different in odd and even lines, but the VPAT group remains the same.

Additionally, the HBLK signal can also be alternated for odd and even lines. When the HBLKALT register is set high, the HBLK TOG1 and TOG2 positions will be used on odd lines and the TOG3–TOG6 positions will be used on even lines. This allows the HBLK interval to be adjusted on odd and even lines if needed.

Figure 19 shows an example of VPAT repetition alternation and HBLK alternation used together. It is also possible to use VPAT and HBLK alternation separately.

Second V-Pattern Group during VSG Active Line

Most CCDs require additional vertical timing during the sensor gate line. The AD9995 supports the option to output a second V-pattern group for V1–V6 during the line when the sensor gates VSG1–VSG5 are active. Figure 20 shows a typical VSG line, which includes two separate sets of V-pattern groups for V1–V6. The V-pattern group at the start of the VSG line is selected in the same manner as the other regions, using the appropriate VSEQSEL register. The second V-pattern group, unique to the VSG line, is selected using the VPATSECOND register, located with the Field registers. The start position of the second VPAT group uses the VPATLEN register from the selected VPAT registers. Because the VPATLEN register is used as the start position and not as the VPAT length, it is not possible to program multiple repetitions for the second VPAT group.

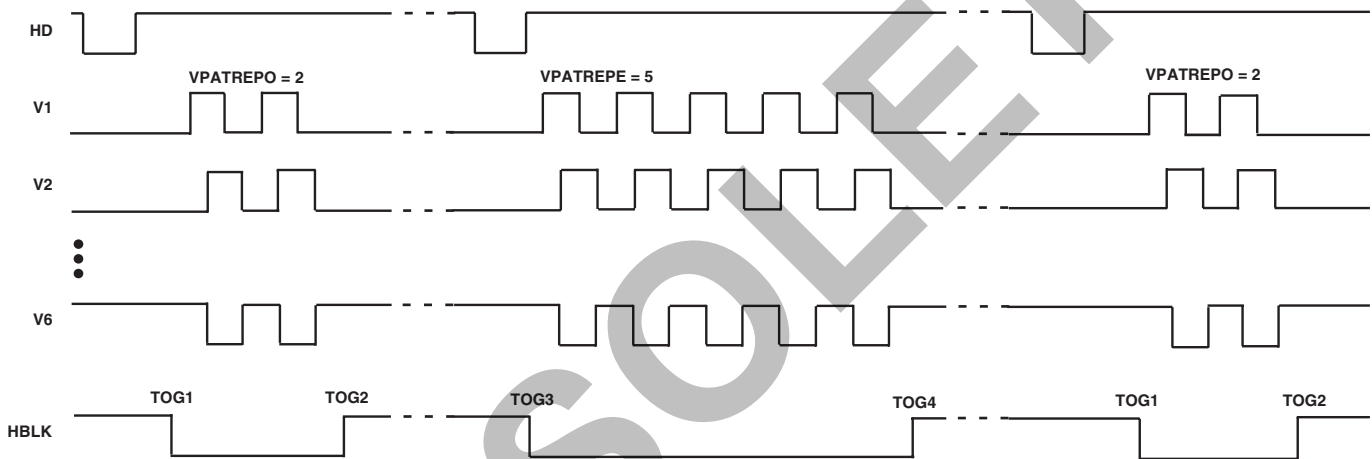

NOTES

1. THE NUMBER OF REPEATS FOR THE V-PATTERN GROUP MAY BE ALTERNATED ON ODD AND EVEN LINES.
2. THE HBLK TOGGLE POSITIONS MAY BE ALTERNATED BETWEEN ODD AND EVEN LINES IN ORDER TO GENERATE DIFFERENT HBLK PATTERNS FOR ODD/EVEN LINES.

Figure 19. Odd/Even Line Alternation of VPAT Repetitions and HBLK Toggle Positions

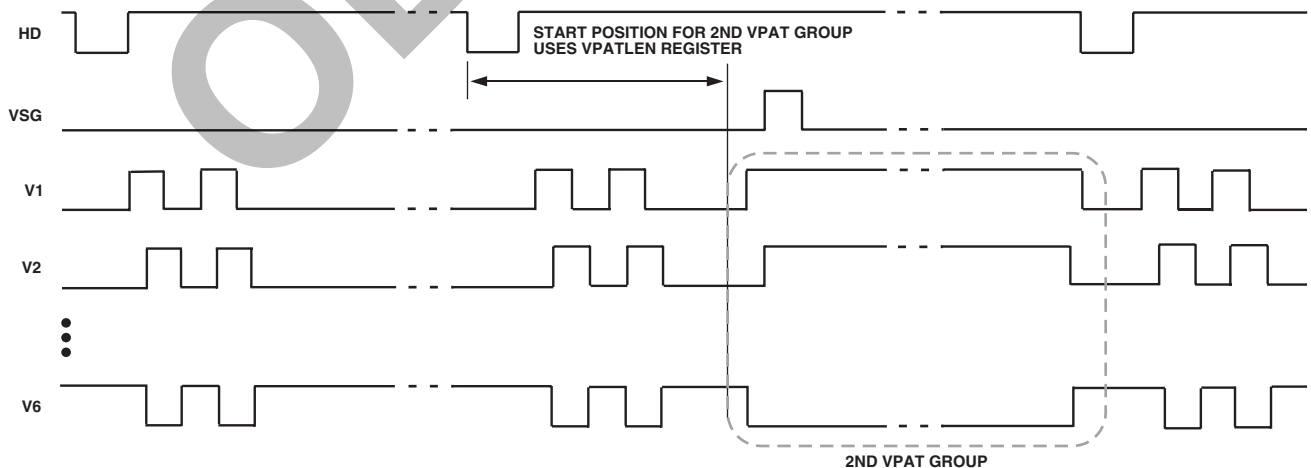

Figure 20. Example of Second VPAT Group during Sensor Gate Line

Sweep Mode Operation

The AD9995 contains an additional mode of vertical timing operation called Sweep mode. This mode is used to generate a large number of repetitive pulses that span multiple HD lines. One example of where this mode is needed is at the start of the CCD readout operation. At the end of the image exposure but before the image is transferred by the sensor gate pulses, the vertical interline CCD registers should be free of all charge. This can be accomplished by quickly shifting out any charge using a long series of pulses from the V1–V6 outputs. Depending on the vertical resolution of the CCD, up to 2,000 or 3,000 clock cycles will be needed to shift the charge out of each vertical CCD line. This operation will span across multiple HD line lengths. Normally, the AD9995's vertical timing must be contained within one HD line length, but when Sweep mode is enabled, the HD boundaries will be ignored until the region is finished. To enable Sweep mode within any region, program the appropriate SWEEP register to high.

Figure 21 shows an example of Sweep mode operation. The number of vertical pulses needed will depend on the vertical resolution of the CCD. The V1–V6 output signals are generated using the V-pattern registers (shown in Table VII). A single pulse is created using the polarity and toggle position registers. The number of repetitions is then programmed to match the number of vertical shifts required by the CCD. Repetitions are programmed in the V-sequence registers using the VPATREP registers. This produces a pulse train of the appropriate length. Normally, the pulse train would be truncated at the end of the HD line length, but with Sweep mode enabled for this region, the HD boundaries will be ignored. In Figure 21, the Sweep

region occupies 23 HD lines. After the Sweep mode region is completed, in the next region, normal sequence operation will resume. When using Sweep mode, be sure to set the region boundaries (using the sequence change positions) to the appropriate lines to prevent the Sweep operation from overlapping the next V-sequence.

Multiplier Mode

To generate very wide vertical timing pulses, a vertical region may be configured into a multiplier region. This mode uses the V-pattern registers in a slightly different manner. Multiplier mode can be used to support unusual CCD timing requirements, such as vertical pulses that are wider than a single HD line length.

The start polarity and toggle positions are still used in the same manner as the standard VPAT group programming, but the VPATLEN is used differently. Instead of using the pixel counter (HD counter) to specify the toggle position locations (VTOG1, 2, 3) of the VPAT group, the VPATLEN is multiplied with the VTOG position to allow very long pulses to be generated. To calculate the exact toggle position, counted in pixels after the start position, use the equation

$$\text{Multiplier Mode Toggle Position} = \text{VTOG} \times \text{VPATLEN}$$

Because the VTOG register is multiplied by VPATLEN, the resolution of the toggle position placement is reduced. If VPATLEN = 4, the toggle position accuracy is now reduced to 4-pixel steps instead of single pixel steps. Table VIII summarizes how the VPAT group registers are used in Multiplier mode operation. In Multiplier mode, the VPATREPO and VPATREPE registers should always be programmed to the same value as the highest toggle position.

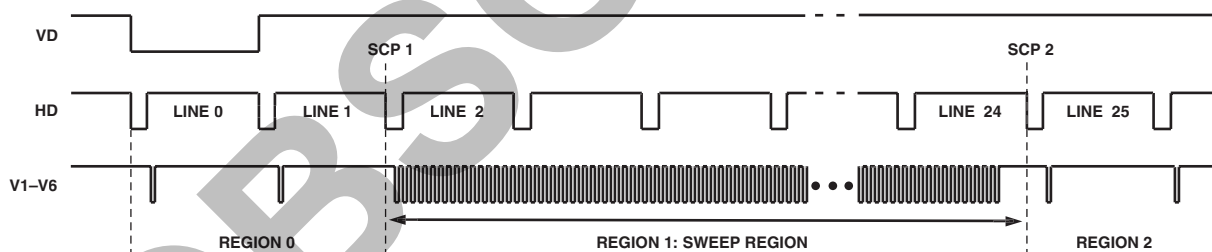

Figure 21. Example of Sweep Region for High Speed Vertical Shift

Table VIII. Multiplier Mode Register Parameters

Register	Length	Range	Description
MULTI	1b	High/Low	High enables Multiplier mode.
VPOL	1b	High/Low	Starting Polarity of V1–V6 Signal in Each VPAT Group.
VTOG1	12b	0–4095 Pixel Location	First Toggle Position for V1–V6 Signal in Each VPAT Group.
VTOG2	12b	0–4095 Pixel Location	Second Toggle Position for V1–V6 Signal in Each VPAT Group.
VTOG3	12b	0–4095 Pixel Location	Third Toggle Position for V1–V6 Signal in Each VPAT Group.
VPATLEN	10b	0–1023 Pixels	Used as Multiplier Factor for Toggle Position Counter.
VPATREP	12b	0–4096	VPATREPE/VPATREPO should be set to the same value as TOG2 or 3.

MODE Register

The MODE register is a single register that selects the field timing of the AD9995. Typically, all of the field, V-sequence, and V-pattern group information is programmed into the AD9995 at startup. During operation, the MODE register allows the user to select any combination of field timing to meet the current requirements of the system. The advantage of using the MODE register in conjunction with preprogrammed timing is that it greatly reduces the system programming requirements during camera operation. Only a few register writes are required when the camera operating mode is changed, rather than having to write in all of the vertical timing information with each camera mode change.

A basic still camera application might require five different fields of vertical timing: one for draft mode operation, one for autofocusing, and three for still image readout. All of the register timing information for the five fields would be loaded at

startup. Then, during camera operation, the MODE register would select which field timing would be active, depending on how the camera was being used.

Table X shows how the MODE register bits are used. The three MSBs, D23–D21, are used to specify how many total fields will be used. Any value from 1 to 7 can be selected using these three bits. The remaining register bits are divided into 3-bit sections to select which of the six fields are used and in which order. Up to seven fields may be used in a single MODE write. The AD9995 will start with the Field timing specified by the first Field bits, and on the next VD will switch to the timing specified by the second Field bits, and so on.

After completing the total number of fields specified in Bits D23 to D21, the AD9995 will repeat by starting at the first Field again. This will continue until a new write to the MODE register occurs. Figure 24 shows example MODE register settings for different field configurations.

Table X. MODE Register Data Bit Breakdown (D23 = MSB)

D23	22	21	20	19	18	17	16	15	14	13	12	11	10	9	8	7	6	5	4	3	2	1	D0
Total Number of Fields to Use.			7th Field			6th Field			5th Field			4th Field			3rd Field			2nd Field			1st Field		
1 = 1st Field Only			0 = Field 0			0 = Field 0			0 = Field 0			0 = Field 0			0 = Field 0			0 = Field 0			0 = Field 0		
7 = All 7 Fields			5 = Field 5			5 = Field 5			5 = Field 5			5 = Field 5			5 = Field 5			5 = Field 5			5 = Field 5		
0 = Invalid			6, 7 = Invalid			6, 7 = Invalid			6, 7 = Invalid			6, 7 = Invalid			6, 7 = Invalid			6, 7 = Invalid			6, 7 = Invalid		

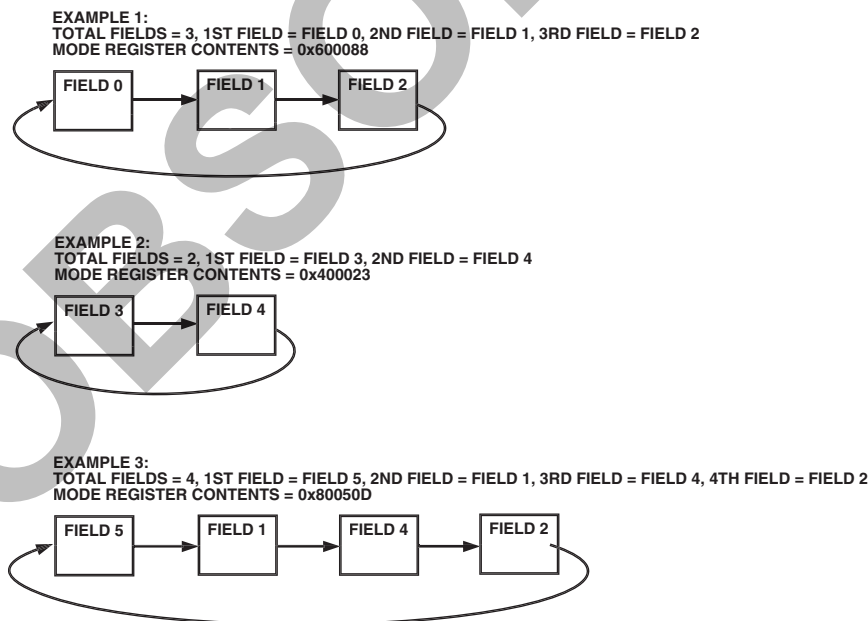

Figure 24. Using the MODE Register to Select Field Timing

AD9995

VERTICAL TIMING EXAMPLE

To better understand how the AD9995's vertical timing generation is used, consider the example CCD timing chart in Figure 25. This particular example illustrates a CCD using a general 3-field readout technique. As described in the Field section, each readout field should be divided into separate regions to perform each step of the readout. The sequence change positions (SCP) determine the line boundaries for each region, and the VSEQSEL registers will then assign a particular V-sequence to each region. The V-sequences will contain the specific timing information required in each region: V1–V6 pulses (using VPAT groups), HBLK/CLPOB timing, and VSG patterns for the SG active lines.

This particular timing example requires four regions for each of the three fields, labeled Region 0, Region 1, Region 2, and Region 3. Because the AD9995 allows up to six individual fields to be programmed, the Field 0, Field 1, and Field 2 registers can be used to meet the requirements of this timing example. The four regions for each field are very similar in this example, but the individual registers for each field allow flexibility to accommodate other timing charts.

Region 0 is a high speed vertical shift region. Sweep mode can be used to generate this timing operation, with the desired number of high speed vertical pulses needed to clear any charge from the CCD's vertical registers.

Region 1 consists of only two lines, and uses standard single line vertical shift timing. The timing of this region area will be the same as the timing in Region 3.

Region 2 is the sensor gate line, where the VSG pulses transfer the image into the vertical CCD registers. This region may require the use of the second V-pattern group for SG active line.

Region 3 also uses the standard single line vertical shift timing, the same timing as Region 1.

In summary, four regions are required in each of the three fields. The timing for Regions 1 and 3 is essentially the same, reducing the complexity of the register programming.

Other registers will need to be used during the actual readout operation, such as the MODE register, shutter control registers (TRIGGER, SUBCK, VSUB, MSHUT, STROBE), and AFE gain register. These registers will be explained in other examples.

Important Note about Signal Polarities

When programming the AD9995 to generate the V1–V6, VSG1–VSG5, and SUBCK signals, it is important to note that the V-driver circuit usually inverts these signals. Carefully check the required timing signals needed at the input and output of the V-driver circuit being used and adjust the polarities of the AD9995's outputs accordingly.

OBSOLETE

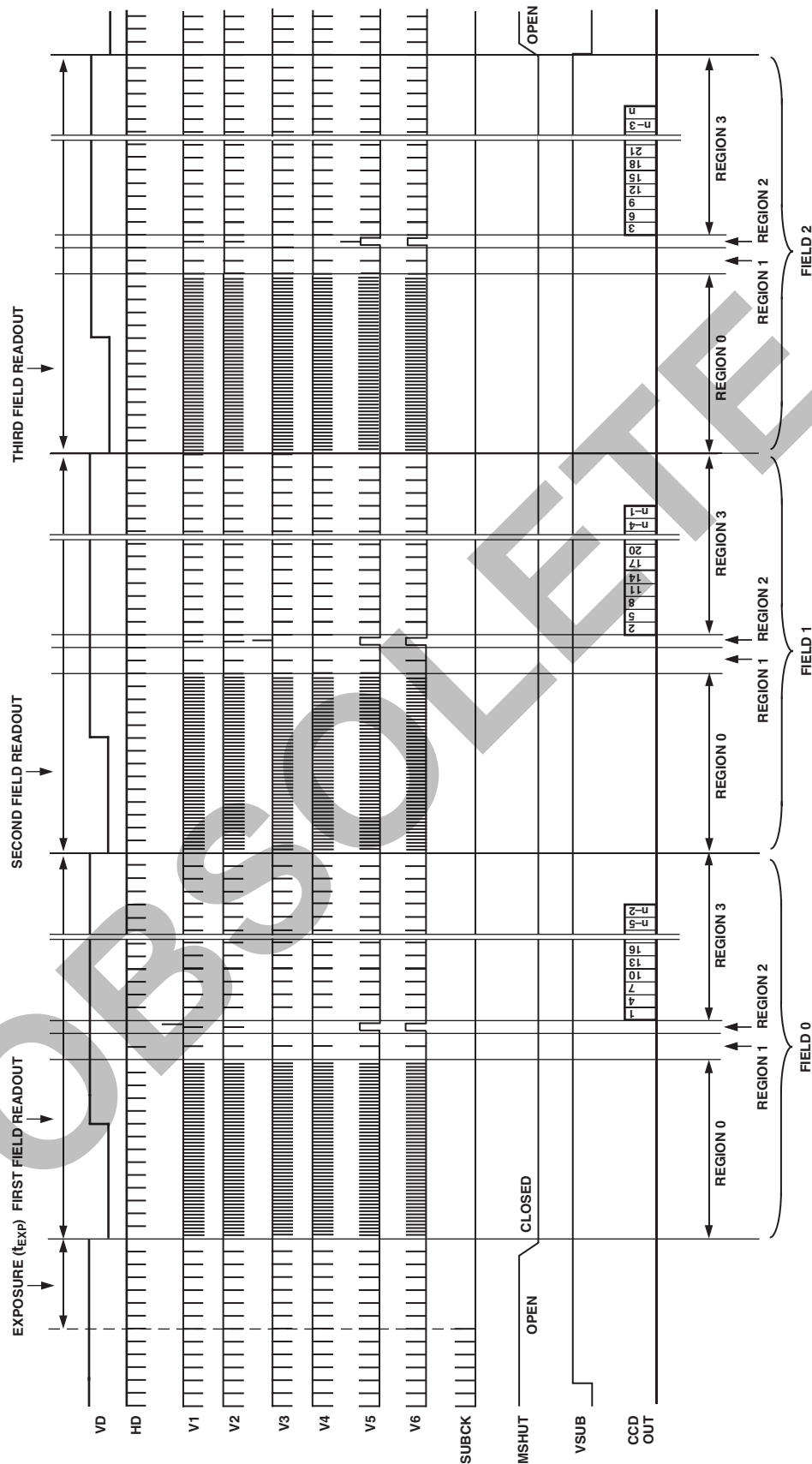

Figure 25. CCD Timing Example: Dividing Each Field into Regions

AD9995

SHUTTER TIMING CONTROL

The CCD image exposure time is controlled by the substrate clock signal (SUBCK), which pulses the CCD substrate to clear out accumulated charge. The AD9995 supports three types of electronic shuttering: normal shutter, high precision shutter, and low speed shutter. Along with the SUBCK pulse placement, the AD9995 can accommodate different readout configurations to further suppress the SUBCK pulses during multiple field readouts. The AD9995 also provides programmable outputs to control an external mechanical shutter (MSHUT), strobe/flash (STROBE), and the CCD bias select signal (VSUB).

Normal Shutter Operation

By default, the AD9995 is always operating in the normal shutter configuration in which the SUBCK signal is pulsing in every VD field (see Figure 26). The SUBCK pulse occurs once per line, and the total number of repetitions within the field will determine the length of the exposure time. The SUBCK pulse polarity and toggle positions within a line are programmable using the SUBCKPOL and SUBCK1TOG registers (see Table XI). The number of SUBCK pulses per field is programmed in the SUBCKNUM register (Addr. 0x63).

As shown in Figure 26, the SUBCK pulses will always begin in the line following the SG active line, which is specified in the SGACTION registers for each field. The SUBCKPOL, SUBCK1TOG, SUBCK2TOG, SUBCKNUM, and SUBCKSUPPRESS registers are updated at the start of the line after the sensor gate line, as described in the Updating New Register Values section.

High Precision Shutter Operation

High precision shuttering is used in the same manner as normal shuttering, but uses an additional register to control the very last SUBCK pulse. In this mode, the SUBCK still pulses once per line, but the last SUBCK in the field will have an additional SUBCK pulse whose location is determined by the SUBCK2TOG register, as shown in Figure 27. Finer resolution of the exposure time is possible using this mode. Leaving the SUBCK2TOG register set to max value (0xFFFFF) will disable the last SUBCK pulse (default setting).

Low Speed Shutter Operation

Normal and high precision shutter operations are used when the exposure time is less than one field long. For long exposure times greater than one field interval, low speed shutter operation is used. The AD9995 uses a separate exposure counter to achieve long exposure times. The number of fields for the low speed shutter operation is specified in the EXPOSURE register (Addr. 0x62). As shown in Figure 28, this shutter mode will suppress the SUBCK and VSG outputs for up to 4095 fields (VD periods). The VD and HD outputs may be suppressed during the exposure period by programming the VDHD OFF register to 1.

To generate a low speed shutter operation, it is necessary to trigger the start of the long exposure by writing to the TRIGGER register bit D3. When this bit is set high, the AD9995 will begin an exposure operation at the next VD edge. If a value greater than zero is specified in the EXPOSURE register, the AD9995 will suppress the SUBCK output on subsequent fields.

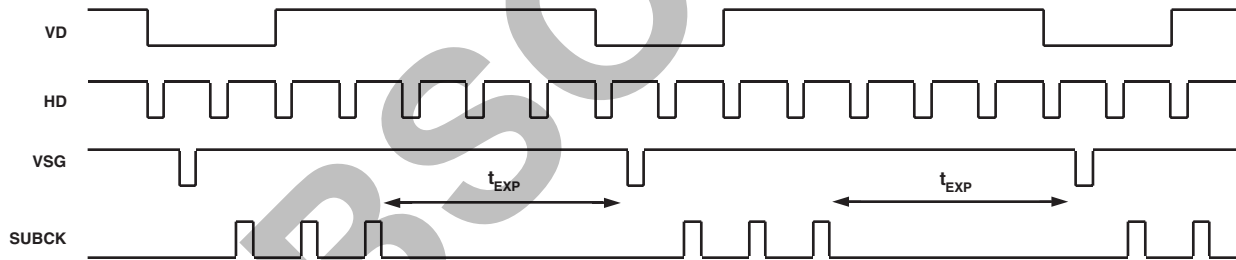

SUBCK PROGRAMMABLE SETTINGS:

1. PULSE POLARITY USING THE SUBCKPOL REGISTER.
2. NUMBER OF PULSES WITHIN THE FIELD USING THE SUBCKNUM REGISTER (SUBCKNUM = 3 IN THE ABOVE FIGURE).
3. PIXEL LOCATION OF PULSE WITHIN THE LINE AND PULSEWIDTH PROGRAMMED USING SUBCK1 TOGGLE POSITION REGISTER.

Figure 26. Normal Shutter Mode

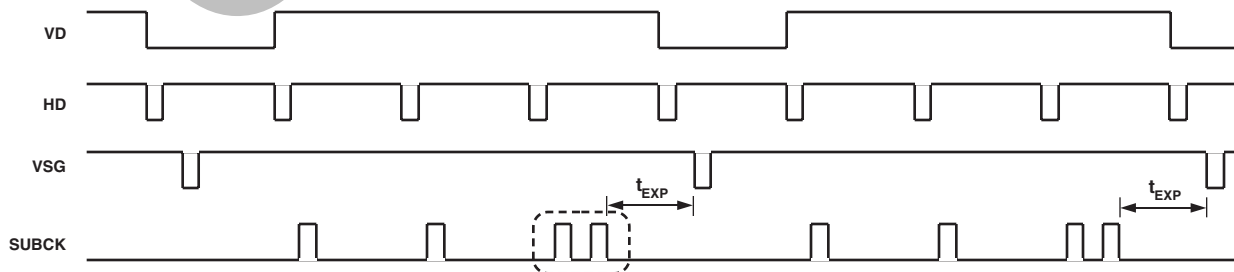

NOTES

1. SECOND SUBCK PULSE IS ADDED IN THE LAST SUBCK LINE.
2. LOCATION OF 2ND PULSE IS FULLY PROGRAMMABLE USING THE SUBCK2 TOGGLE POSITION REGISTER.

Figure 27. High Precision Shutter Mode

If the exposure is generated using the TRIGGER register and the EXPOSURE register is set to zero, the behavior of the SUBCK will not be any different than the normal shutter or high precision shutter operations, in which the TRIGGER register is not used.

SUBCK Suppression

Normally, the SUBCKs will begin to pulse on the line following the sensor gate line (VSG). With some CCDs, the SUBCK pulse needs to be suppressed for one or more lines following the VSG line. The SUBCKSUPPRESS register allows for suppression of the SUBCK pulses for additional lines following the VSG line.

Readout after Exposure

After the exposure, the readout of the CCD data occurs, beginning with the sensor gate (VSG) operation. By default, the AD9995 is generating the VSG pulses in every field. In the case where only a single exposure and single readout frame are needed, such as the CCD's preview mode, the VSG and SUBCK pulses can be operating in every field.

However in many cases, during readout the SUBCK output needs to be further suppressed until the readout is completed. The READOUT register specifies the number of additional fields after the exposure to continue the suppression of SUBCK. READOUT can be programmed for zero to seven additional fields, and should be preprogrammed at startup, not at the same time as the exposure write. A typical interlaced

CCD frame readout mode will generally require two additional fields of SUBCK suppression (READOUT = 2). A 3-field, 6-phase CCD will require three additional fields of SUBCK suppression after the readout begins (READOUT = 3).

If the SUBCK output is required to start back up during the last field of readout, simply program the READOUT register to one less than the total number of CCD readout fields.

Like the exposure operation, the readout operation must be triggered by using the TRIGGER register.

Using the TRIGGER Register

As described previously, by default the AD9995 will output the SUBCK and VSG signals on every field. This works well for continuous single field exposure and readout operations, such as the CCD's live preview mode. However, if the CCD requires a longer exposure time, or if multiple readout fields are needed, the TRIGGER register is needed to initiate specific exposure and readout sequences.

Typically, the exposure and readout bits in the TRIGGER register are used together. This will initiate a complete exposure-plus-readout operation. Once the exposure has been completed, the readout will automatically occur. The values in the EXPOSURE and READOUT registers will determine the length of each operation.

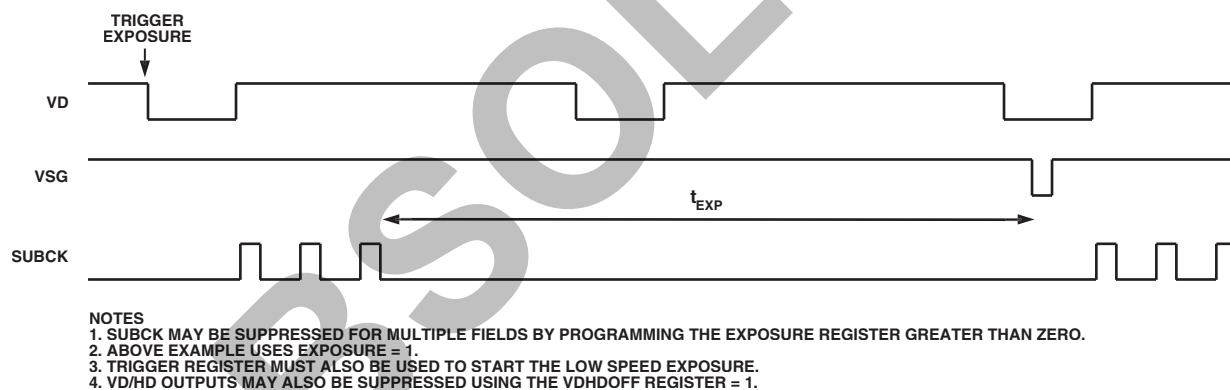

Figure 28. Low Speed Shutter Mode Using EXPOSURE Register

Table XI. Shutter Mode Register Parameters

Register	Length	Range	Description
TRIGGER	5b	On/Off for Five Signals	Trigger for VSUB [0], MSHUT [1], STROBE [2], Exposure [3], and Readout Start [4]
READOUT	3b	0-7 # of Fields	Number of Fields to Suppress SUBCK after Exposure
EXPOSURE	12b	0-4095 # of Fields	Number of Fields to Suppress to SUBCK and VSG during Exposure Time (Low Speed Shutter)
VDHDOFF	1b	On/Off	Disable VD/HD Output during Exposure (1 = On, 0 = Off)
SUBCKPOL*	1b	High/Low	SUBCK Start Polarity for SUBCK1 and SUBCK2
SUBCK1TOG*	24b	0-4095 Pixel Locations	Toggle Positions for First SUBCK Pulse (Normal Shutter)
SUBCK2TOG*	24b	0-4095 Pixel Locations	Toggle Positions for Second SUBCK Pulse in Last Line (High Precision)
SUBCKNUM*	12b	1-4095 # of Pulses	Total Number of SUBCKs per Field at One Pulse per Line
SUBCKSUPPRESS*	12b	0-4095 # of Pulses	Number of Lines to Further Suppress SUBCK after the VSG Line

*Register is not VD updated, but is updated at the start of line after sensor gate line.

AD9995

It is possible to independently trigger the readout operation without triggering the exposure operation. This will cause the readout to occur at the next VD, and the SUBCK output will be suppressed according to the value of the READOUT register.

The TRIGGER register is also used to control the STROBE, MSHUT, and VSUB signal transitions. Each of these signals are individually controlled, although they will be dependent on the triggering of the exposure and readout operation.

See Figure 32 for a complete example of triggering the exposure and readout operations.

VSUB Control

The CCD readout bias (VSUB) can be programmed to accommodate different CCDs. Figure 29 shows two different modes that are available. In Mode 0, VSUB goes active during the field of the last SUBCK when the exposure begins. The On position (rising edge in Figure 29) is programmable to any line within

the field. VSUB will remain active until the end of the image readout. In Mode 1, the VSUB is not activated until the start of the readout.

An additional function called VSUB KEEP-ON is also available. When this bit is set high, the VSUB output will remain on (active) even after the readout has finished. To disable the VSUB at a later time, set this bit back to low.

MSHUT and STROBE Control

MSHUT and STROBE operation is shown in Figures 30, 31, and 32. Table XII shows the register parameters for controlling the MSHUT and STROBE outputs. The MSHUT output is switched on with the MSHUTON registers, and will remain on until the location specified in the MSHUTOFF registers. The location of MSHUTOFF is fully programmable to anywhere within the exposure period, using the FD (field), LN (line), and PX (pixel) registers. The STROBE pulse is defined by the on and

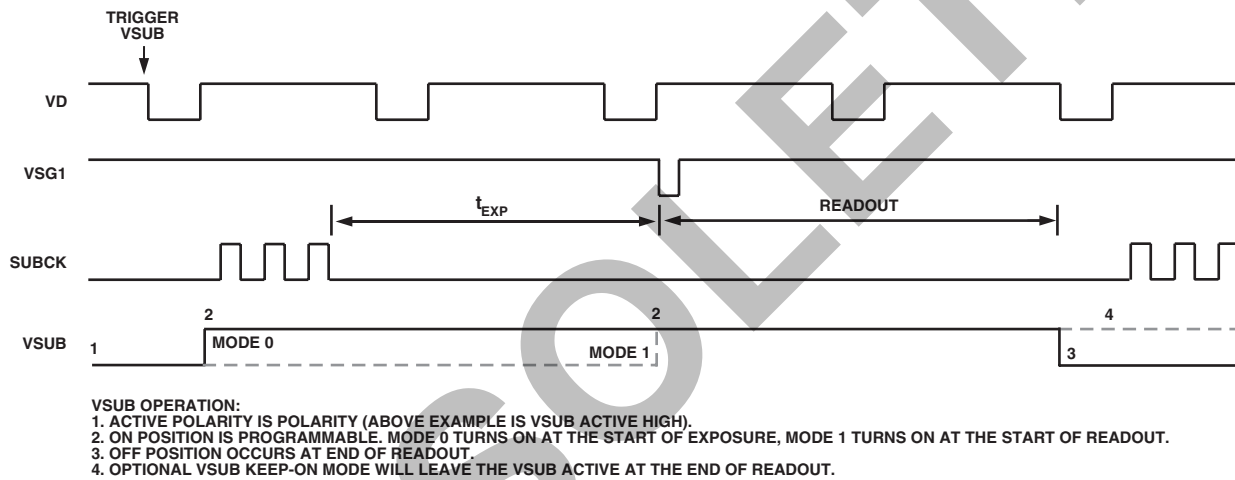

Figure 29. VSUB Programmability

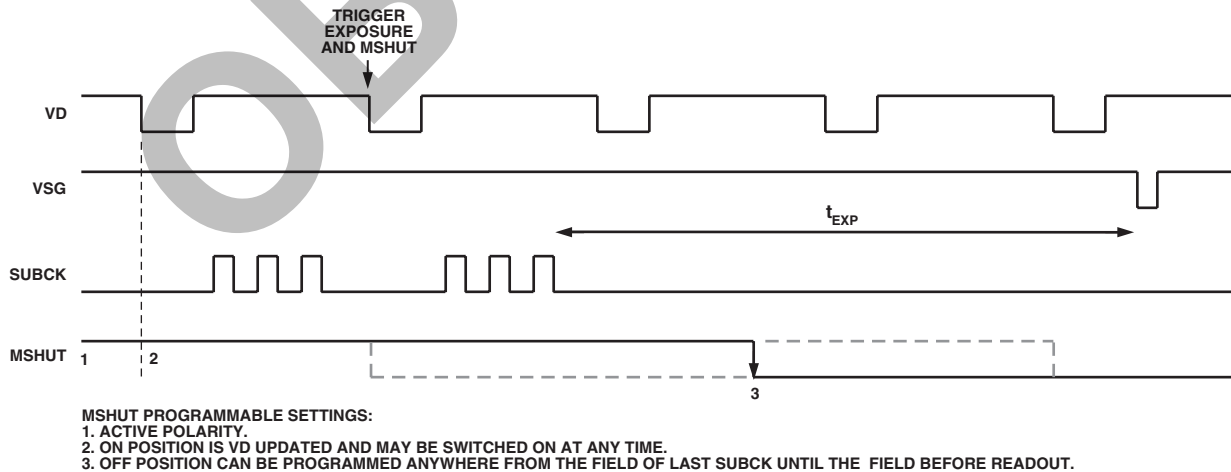

Figure 30. MSHUT Output Programmability

off positions. STROBON_FD is the field in which the STROBE is turned on, measured from the field containing the last SUBCK before exposure begins. The STROBON_LN PX register gives the line and pixel positions with respect to STROBON_FD. The STROBE off position is programmable to any field, line, and pixel location with respect to the field of the last SUBCK.

TRIGGER Register Limitations

While the TRIGGER register can be used to perform a complete exposure and readout operation, there are limitations on its use.

Once an exposure-plus-readout operation has been triggered, another exposure/readout operation cannot be triggered right away. There must be at least one idle field (VD intervals) before the next exposure/readout can be triggered.

The same limitation applies to the triggering of the MSHUT signal. There must be at least one idle field after the completion of the MSHUT OFF operation before another MSHUT OFF operation may be programmed.

The VSUB trigger requires two idle fields between exposure/readout operations in order to ensure proper VSUB on/off triggering. If the VSUB signal is not required to be turned on and off in between each successive exposure/readout operation, this limitation can be ignored. The VSUB Keep-On mode is useful when successive exposure/readout operations are required.

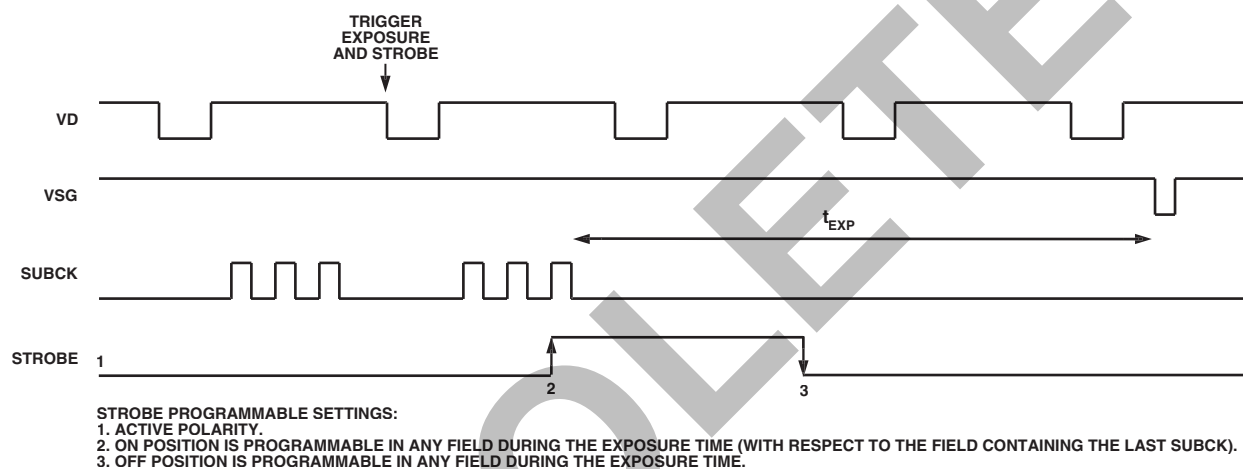

Figure 31. STROBE Output Programmability

Table XII. VSUB, MSHUT, and STROBE Register Parameters

Register	Length	Range	Description
VSUBMODE[0]	1b	High/Low	VSUB Mode (0 = Mode 0, 1 = Mode 1) (See Figure 29).
VSUBMODE[1]	1b	High/Low	VSUB Keep-On Mode. VSUB will stay active after readout when set high.
VSUBON[11:0]	12b	0–4095 Line Location	VSUB On Position. Active starting in any line of field.
VSUBON[12]	1b	High/Low	VSUB Active Polarity.
MSHUTPOL[0]	1b	High/Low	MSHUT Active Polarity.
MSHUTPOL[1]	1b	On/Off	MSHUT Manual Enable (1 = Active or Open).
MSHUTON	24b	0–4095 Line/Pix Location	MSHUT On Position Line [11:0] and Pixel [23:12] Location.
MSHUTOFF_FD	12b	0–4095 Field Location	Field Location to Switch Off MSHUT (Inactive or Closed).
MSHUTOFF_LN PX	24b	0–4095 Line/Pix Location	Line/Pixel Position to Switch Off MSHUT (Inactive or Closed).
STROBPOL	1b	High/Low	STROBE Active Polarity.
STROBON_FD	12b	0–4095 Field Location	STROBE ON Field Location, with Respect to Last SUBCK Field.
STROBON_LN PX	24b	0–4095 Line/Pix Location	STROBE ON Line/Pixel Position.
STROBOFF_FD	12b	0–4095 Field Location	STROBE OFF Field Location, with Respect to Last SUBCK Field.
STROBOFF_LN PX	24b	0–4095 Line/Pix Location	STROBE OFF Line/Pixel Position.

EXPOSURE AND READOUT EXAMPLE

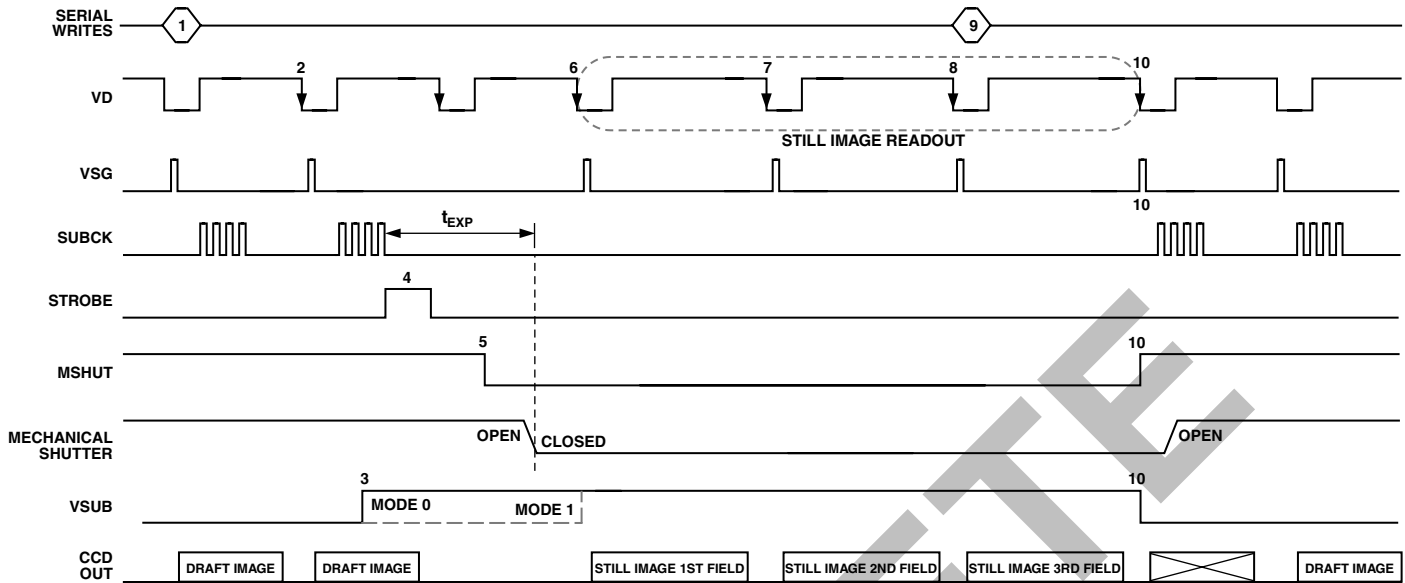

Figure 32. Example of Exposure and Still Image Readout Using Shutter Signals and Mode Register

1. Write to the READOUT register (Addr. 0x61) to specify the number of fields to further suppress SUBCK while the CCD data is read out. In this example, READOUT = 3.
Write to the EXPOSURE register (Addr. 0x62) to specify the number of fields to suppress SUBCK and VSG outputs during exposure. In this example, EXPOSURE = 1.
Write to the TRIGGER register (Addr. 0x60) to enable the STROBE, MSHUT, and VSUB signals, and to start the exposure/readout operation. To trigger all of these events (as in Figure 32), set the register TRIGGER = 31. Readout will automatically occur after the exposure period is finished.
Write to the MODE register (Addr. 0x1B) to configure the next five fields. The first two fields during exposure are the same as the current draft mode fields, and the following three fields are the still frame readout fields. The registers for the Draft mode field and the three readout fields have already been programmed.
2. VD/HD falling edge will update the serial writes from 1.
3. If VSUB mode = 0 (Addr. 0x67), VSUB output turns on at the line specified in the VSUBON register (Addr. 0x68).
4. STROBE output turns on and off at the location specified in the STROBEON and OFF registers (Addr. 0x6E to Addr. 0x71).
5. MSHUT output turns off at the location specified in the MSHUTOFF registers (Addr. 0x6B and 0x6C).
6. The next VD falling edge will automatically start the first readout field.
7. The next VD falling edge will automatically start the second readout field.
8. The next VD falling edge will automatically start the third readout field.
9. Write to the MODE register to reconfigure the single Draft mode field timing.
Write to the MSHUTON register (Addr. 0x6A) to open the mechanical shutter.
10. VD/HD falling edge will update the serial write from 9.
VSG outputs return to Draft mode timing.
SUBCK output resumes operation.
MSHUT output returns to the on position (active or open).
VSUB output returns to the off position (inactive).

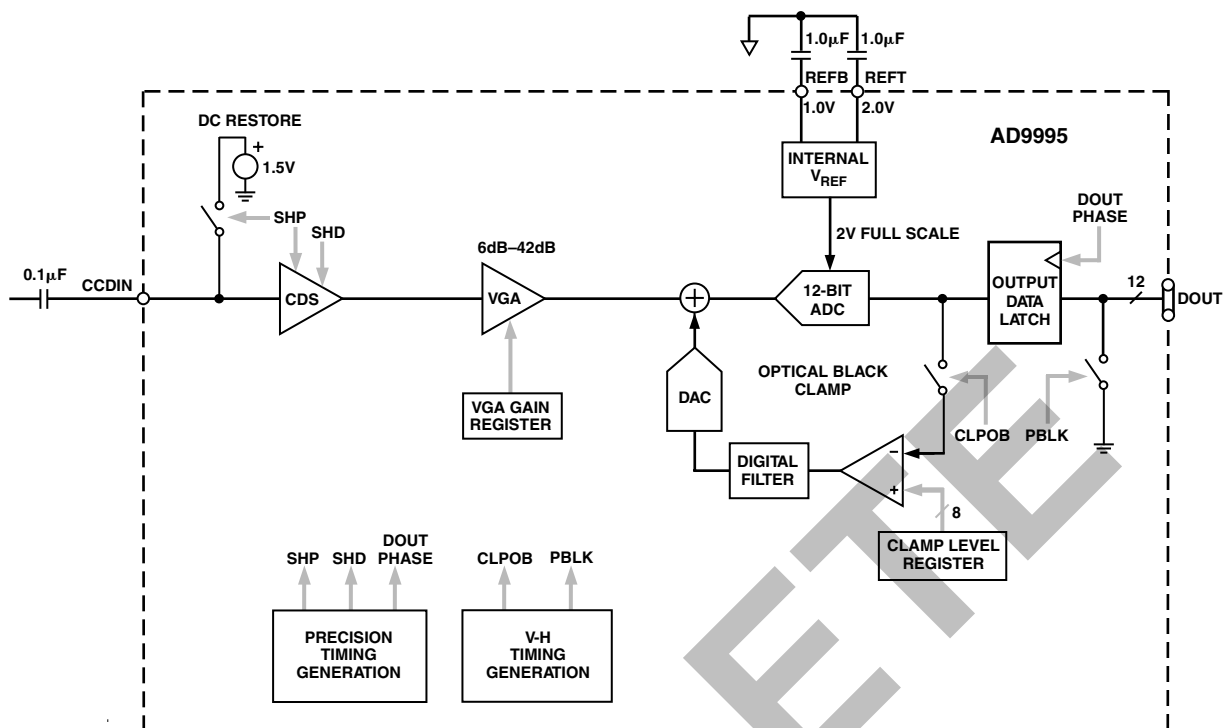

Figure 33. Analog Front End Functional Block Diagram

ANALOG FRONT END DESCRIPTION AND OPERATION

The AD9995 signal processing chain is shown in Figure 33. Each processing step is essential in achieving a high quality image from the raw CCD pixel data.

DC Restore

To reduce the large dc offset of the CCD output signal, a dc restore circuit is used with an external $0.1 \mu\text{F}$ series coupling capacitor. This restores the dc level of the CCD signal to approximately 1.5 V, to be compatible with the 3 V supply voltage of the AD9995.

Correlated Double Sampler

The CDS circuit samples each CCD pixel twice to extract the video information and reject low frequency noise. The timing shown in Figure 7 illustrates how the two internally generated CDS clocks, SHP and SHD, are used to sample the reference level and level of the CCD signal, respectively. The placement of the SHP and SHD sampling edges is determined by the setting of the SAMPCONTROL register located at Addr. 0x63. Placement of these two clock signals is critical in achieving the best performance from the CCD.

Variable Gain Amplifier

The VGA stage provides a gain range of 6 dB to 42 dB, programmable with 10-bit resolution through the serial digital interface. The minimum gain of 6 dB is needed to match a 1 V input signal

with the ADC full-scale range of 2 V. When compared to 1 V full-scale systems, the equivalent gain range is 0 dB to 36 dB.

The VGA gain curve follows a linear-in-dB characteristic. The exact VGA gain can be calculated for any gain register value by using the equation

$$\text{Gain (dB)} = (0.0351 \times \text{Code}) + 6 \text{ dB}$$

where the code range is 0 to 1023.

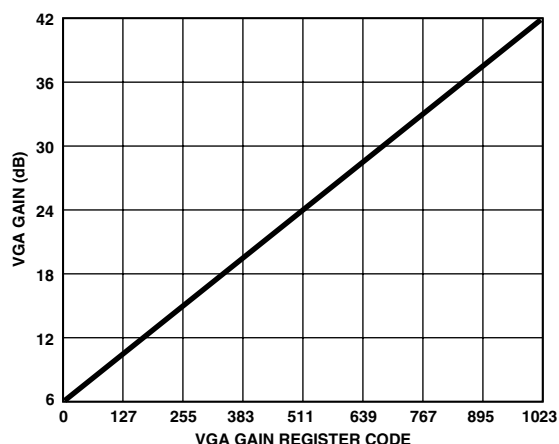

Figure 34. VGA Gain Curve

AD9995

A/D Converter

The AD9995 uses a high performance ADC architecture optimized for high speed and low power. Differential nonlinearity (DNL) performance is typically better than 0.5 LSB. The ADC uses a 2 V input range. See TPC 2 and TPC 3 for typical linearity and noise performance plots for the AD9995.

Optical Black Clamp

The optical black clamp loop is used to remove residual offsets in the signal chain and to track low frequency variations in the CCD's black level. During the optical black (shielded) pixel interval on each line, the ADC output is compared with a fixed black level reference, selected by the user in the Clamp Level register. The value can be programmed between 0 LSB and 255 LSB in 256 steps. The resulting error signal is filtered to reduce noise, and the correction value is applied to the ADC input through a D/A converter. Normally, the optical black clamp loop is turned on once per horizontal line, but this loop can be updated more slowly to suit a particular application. If external digital clamping is used during the postprocessing, the AD9995 optical black clamping may be disabled using Bit D2 in the OPRMODE register. When the loop is disabled, the Clamp Level register may still be used to provide programmable offset adjustment.

The CLPOB pulse should be placed during the CCD's optical black pixels. It is recommended that the CLPOB pulse duration be at least 20 pixels wide to minimize clamp noise. Shorter pulsewidths may be used, but clamp noise may increase, and the ability to track low frequency variations in the black level will be reduced. See the Horizontal Clamping and Blanking section and the Horizontal Timing Sequence Example section for timing examples.

Digital Data Outputs

The AD9995 digital output data is latched using the DOUT PHASE register value, as shown in Figure 33. Output data timing is shown in Figure 8a. It is also possible to leave the output latches transparent so that the data outputs are valid immediately from the A/D converter. Programming the AFE CONTROL register bit D4 to 1 will set the output latches transparent. The data outputs can also be disabled (three-stated) by setting the AFE CONTROL register Bit D3 to 1.

The data output coding is normally straight binary, but the coding may be changed to gray coding by setting the AFE CONTROL register Bit D5 to 1.

OBSOLETE

POWER-UP AND SYNCHRONIZATION

Recommended Power-Up Sequence for Master Mode

When the AD9995 is powered up, the following sequence is recommended (refer to Figure 35 for each step). Note that a SYNC signal is required for Master mode operation. If an external SYNC pulse is not available, it is also possible generate an internal SYNC pulse by writing to the SYNCPOL register, as described in the next section.

1. Turn on power supplies for AD9995.
2. Apply the master clock input CLI.
3. Reset the internal AD9995 registers by writing a 1 to the SW_RESET register (Addr. 0x10 in Bank 1).
4. By default, the AD9995 is in Standby3 mode. To place the part into normal power operation, write 0x004 to the AFE_OPRMODE register (Addr. 0x00 in Bank 1).
5. Write a 1 to the BANKSELECT register (Addr. 0x7F). This will select Register Bank 2.
6. Load Bank 2 registers with the required VPAT group, V-sequence, and field timing information.
7. Write a 0 to the BANKSELECT register to select Bank 1.
8. By default, the internal timing core is held in a reset state with TG_CORE_RSTB register = 0. Write a 1 to the TG_CORE_RSTB register (Addr. 0x15 in Bank 1) to start the internal timing core operation.
9. Load the required registers to configure the high speed timing, horizontal timing, and shutter timing information.
10. Configure the AD9995 for Master mode timing by writing a 1 to the MASTER register (Addr. 0x20 in Bank 1).

11. Write a 1 to the OUT_CONTROL register (Addr. 0x11 in Bank 1). This will allow the outputs to become active after the next SYNC rising edge.
12. Generate a SYNC event: If SYNC is high at power-up, bring the SYNC input low for a minimum of 100 ns. Then bring SYNC back high. This will cause the internal counters to reset and will start VD/HD operation. The first VD/HD edge allows most Bank 1 register updates to occur, including OUT_CONTROL to enable all outputs.

Table XIII. Power-Up Register Write Sequence

Address	Data	Description
0x10	0x01	Reset All Registers to Default Values
0x00	0x04	Power Up the AFE and CLO Oscillator
0x7F	0x01	Select Register Bank 2
0x00–0xFF		VPAT, V-Sequence, and Field Timing
0x7F	0x00	Select Register Bank 1
0x15	0x01	Reset Internal Timing Core
0x30–71		Horizontal and Shutter Timing
0x20	0x01	Configure for Master Mode
0x11	0x01	Enable All Outputs after SYNC
0x13	0x01	SYNCPOL (for Software SYNC Only)

Generating Software SYNC without External SYNC Signal

If an external SYNC pulse is not available, it is possible to generate an internal SYNC in the AD9995 by writing to the SYNCPOL register (Addr. 0x13). If the software SYNC option is used, the SYNC input (Pin 46) should be tied to ground (VSS).

After power-up, follow the same procedure as before for Steps 1 to 11. Then, for Step 12, instead of using the external SYNC pulse, write a 1 to the SYNCPOL register. This will generate the SYNC internally, and timing operation will begin.

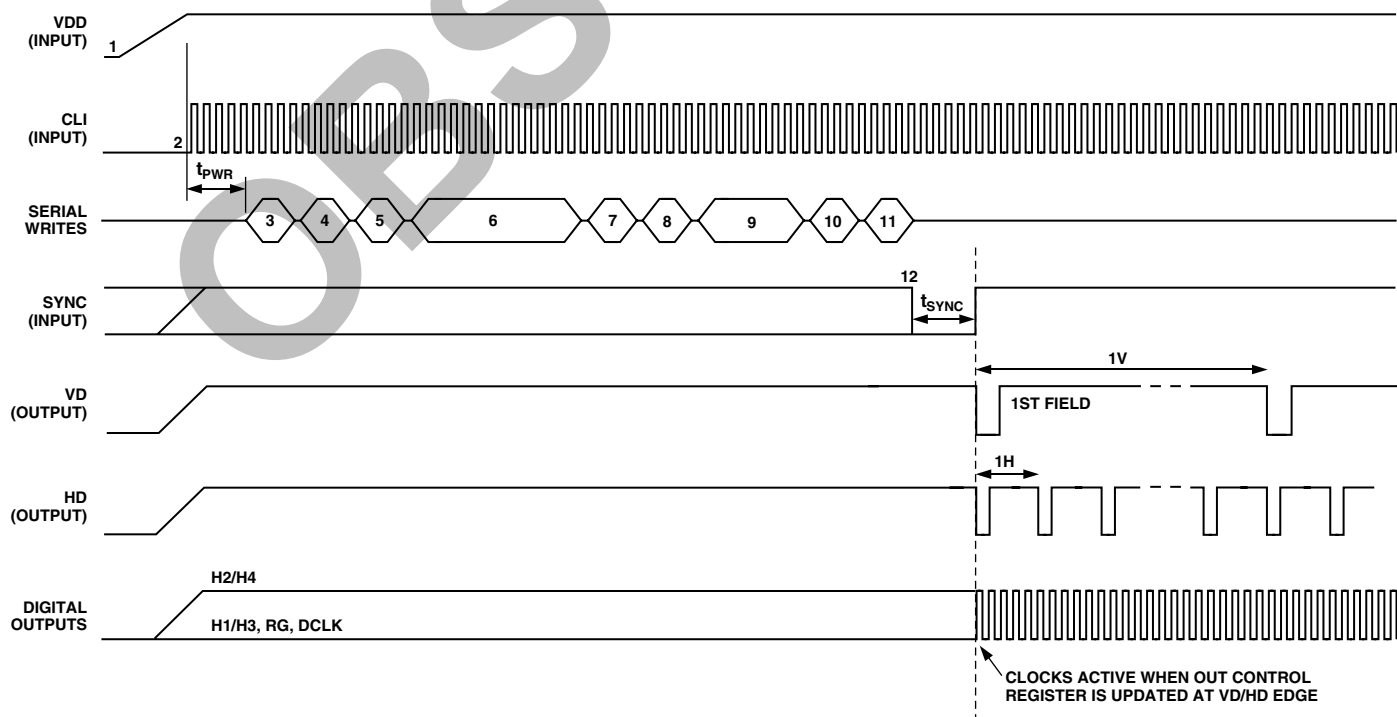

Figure 35. Recommended Power-Up Sequence and Synchronization, Master Mode

Table XIV. Standby Mode Operation

I/O Block	Standby 3 (Default) ^{1,2}	OUT_CONT = LO ^{2,3}	Standby 2 ^{3,4}	Standby 1 ^{3,4}
AFE	OFF	No Change	OFF	Only REFT, REFB ON
Timing Core	OFF	No Change	OFF	ON
CLO Oscillator	OFF	No Change	ON	ON
CLO	HI	Running	Running	Running
V1	LO	LO	LO	LO
V2	LO	LO	LO	LO
V3	LO	LO	LO	LO
V4	LO	LO	LO	LO
V5	LO	HI	HI	HI
V6	LO	HI	HI	HI
VSG1	LO	HI	HI	HI
VSG2	LO	HI	HI	HI
VSG3	LO	HI	HI	HI
VSG4	LO	HI	HI	HI
VSG5	LO	HI	HI	HI
SUBCK	LO	HI	HI	HI
VSUB	LO	LO	LO	LO
MSHUT	LO	LO	LO	LO
STROBE	LO	LO	LO	LO
H1	Hi-Z	LO	LO (4.3 mA)	LO (4.3 mA)
H2	Hi-Z	HI	HI (4.3 mA)	HI (4.3 mA)
H3	Hi-Z	LO	LO (4.3 mA)	LO (4.3 mA)
H4	Hi-Z	HI	HI (4.3 mA)	HI (4.3 mA)
RG	Hi-Z	LO	LO (4.3 mA)	LO (4.3 mA)
VD	LO	VDHDPOL Value	VDHDPOL Value	Running
HD	LO	VDHDPOL Value	VDHDPOL Value	Running
DCLK	LO	LO	LO	Running
DOUT	LO	LO	LO	LO

NOTES

¹ To exit Standby 3, first write 00 to OPRMODE[1:0], then reset the Timing Core after ~500 μ s to guarantee proper settling of the oscillator.

² Standby 3 mode takes priority over OUT_CONTROL for determining the output polarities.

³ These polarities assume OUT_CONT = HI because OUT_CONTROL = LO takes priority over Standby 1 and 2.

⁴ Standby 1 and 2 will set H and RG drive strength to minimum value (4.3 mA).

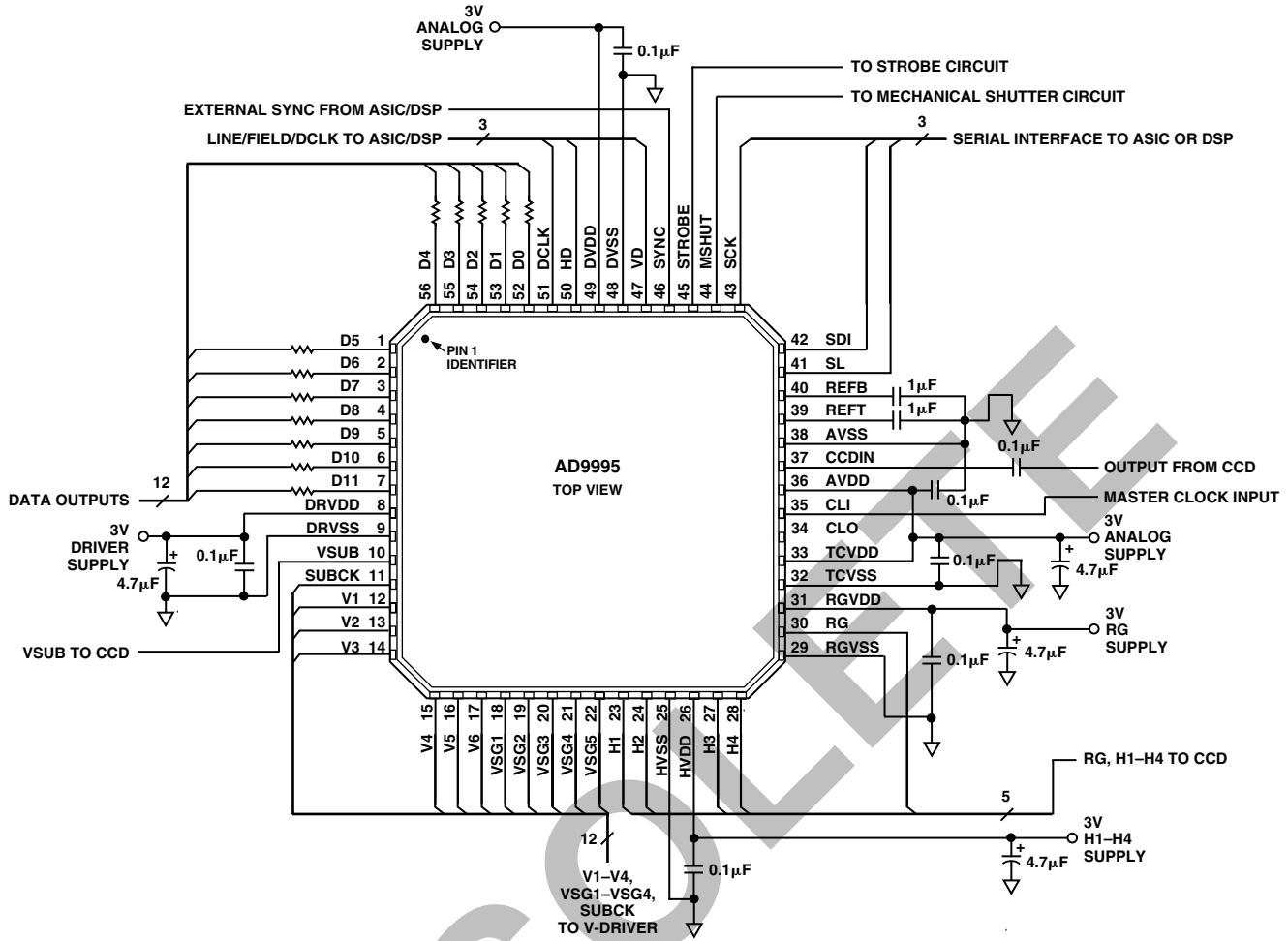

Figure 38. Typical Circuit Configuration

CIRCUIT LAYOUT INFORMATION

The AD9995 typical circuit connection is shown in Figure 38. The PCB layout is critical in achieving good image quality from the AD999x products. All of the supply pins, particularly the AVDD1, TCVDD, RGVDD, and HVDD supplies, must be decoupled to ground with good quality, high frequency chip capacitors. The decoupling capacitors should be located as close as possible to the supply pins and should have a very low impedance path to a continuous ground plane. There should also be a 4.7 µF or larger value bypass capacitor for each main supply—AVDD, RGVDD, HVDD, and DRVDD—although this is not necessary for each individual pin. In most applications, it is easier to share the supply for RGVDD and HVDD, which may be done as long as the individual supply pins are separately bypassed. A separate 3 V supply may also be used for DRVDD, but this supply pin should still be decoupled to the same ground plane as the rest of the chip. A separate ground for DRVSS is not recommended. It is recommended that the exposed paddle on the bottom of the package be soldered to a large pad, with multiple vias connecting the pad to the ground plane.

The analog bypass pins (REFB, REFB) should also be carefully decoupled to ground as close as possible to their respective pins. The analog input (CCDIN) capacitor should also be located close to the pin.

The H1–H4 and RG traces should be designed to have low inductance to avoid excessive distortion of the signals. Heavier traces are recommended because of the large transient current demand on H1–H4 by the CCD. If possible, locating the AD9995 physically closer to the CCD will reduce the inductance on these lines. As always, the routing path should be as direct as possible from the AD9995 to the CCD.

The AD9995 also contains an on-chip oscillator for driving an external crystal. Figure 39 shows an example application using a typical 24 MHz crystal. For the exact values of the external resistors and capacitors, it is best to consult with the crystal manufacturer’s data sheet.

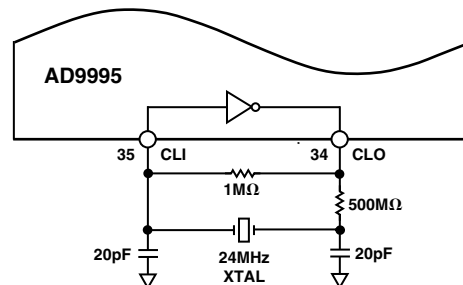
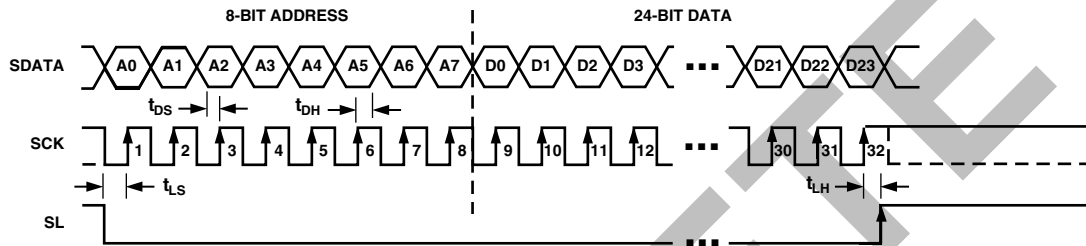

Figure 39. Crystal Driver Application

SERIAL INTERFACE TIMING

All of the internal registers of the AD9995 are accessed through a 3-wire serial interface. Each register consists of an 8-bit address and a 24-bit data-word. Both the 8-bit address and 24-bit data-word are written starting with the LSB. To write to each register, a 32-bit operation is required, as shown in Figure 40a. Although many registers are fewer than 24 bits wide, all 24 bits must be written for each register. For example, if the register is only 10 bits wide, the upper 14 bits are don't cares and may be filled with 0s during the serial write operation. If fewer than 24 bits are written, the register will not be updated with new data.

Figure 40b shows a more efficient way to write to the registers, using the AD9995's address auto-increment capability. Using this method, the lowest desired address is written first, followed by multiple 24-bit data-words. Each new 24-bit data-word will automatically be written to the next highest register address. By eliminating the need to write each 8-bit address, faster register loading is achieved. Continuous write operations may be used starting with any register location, and may be used to write to as few as two registers, or as many as the entire register space.



- NOTES**
1. SDATA BITS ARE LATCHED ON SCK RISING EDGES. SCK MAY IDLE HIGH OR LOW IN BETWEEN WRITE OPERATIONS.
 2. ALL 32 BITS MUST BE WRITTEN: 8 BITS FOR ADDRESS AND 24 BITS FOR DATA.
 3. IF THE REGISTER LENGTH IS <24 BITS, "DON'T CARE" BITS MUST BE USED TO COMPLETE THE 24-BIT DATA LENGTH.
 4. NEW DATA VALUES ARE UPDATED IN THE SPECIFIED REGISTER LOCATION AT DIFFERENT TIMES, DEPENDING ON THE PARTICULAR REGISTER WRITTEN TO. SEE THE REGISTER UPDATES SECTION FOR MORE INFORMATION.

Figure 40a. Serial Write Operation

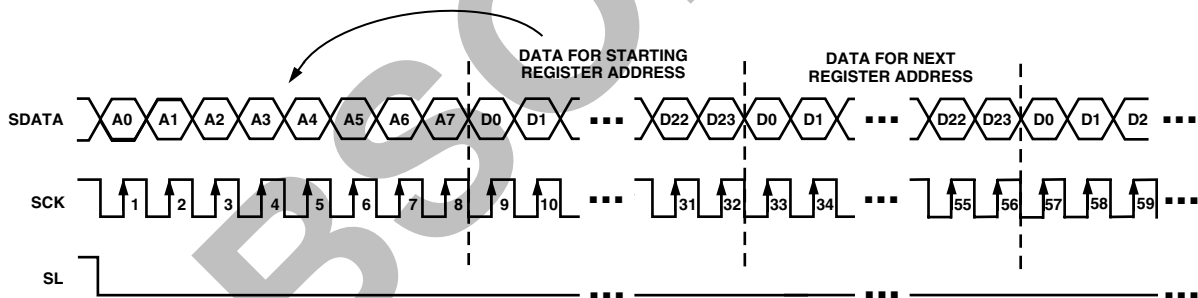

- NOTES**
1. MULTIPLE SEQUENTIAL REGISTERS MAY BE LOADED CONTINUOUSLY.
 2. THE FIRST (LOWEST ADDRESS) REGISTER ADDRESS IS WRITTEN, FOLLOWED BY MULTIPLE 24-BIT DATA-WORDS.
 3. THE ADDRESS WILL AUTOMATICALLY INCREMENT WITH EACH 24-BIT DATA-WORD (ALL 24 BITS MUST BE WRITTEN).
 4. SL IS HELD LOW UNTIL THE LAST DESIRED REGISTER HAS BEEN LOADED.

Figure 40b. Continuous Serial Write Operation

AD9995

Register Address Banks 1 and 2

The AD9995 address space is divided into two different register banks, referred to as Register Bank 1 and Register Bank 2. Figure 41 illustrates how the two banks are divided. Register Bank 1 contains the registers for the AFE, miscellaneous functions, VD/HD parameters, timing core, CLPOB masking, VSG patterns, and shutter functions. Register Bank 2 contains all of the information for the V-pattern groups, V-sequences, and field information.

When writing to the AD9995, Address 0x7F is used to specify which address bank is being written to. To write to Bank 1, the LSB of Address 0x7F should be set to 0; to write to Bank 2, the LSB of Address 0x7F should be set to 1.

Note that Register Bank 1 contains many unused addresses. Any undefined addresses between 0x00 and 0x7F are considered don't cares, and it is acceptable if these addresses are filled in with all 0s during a continuous register write operation. However, the undefined addresses above 0x7F must not be written to, or the AD9995 may not operate properly.

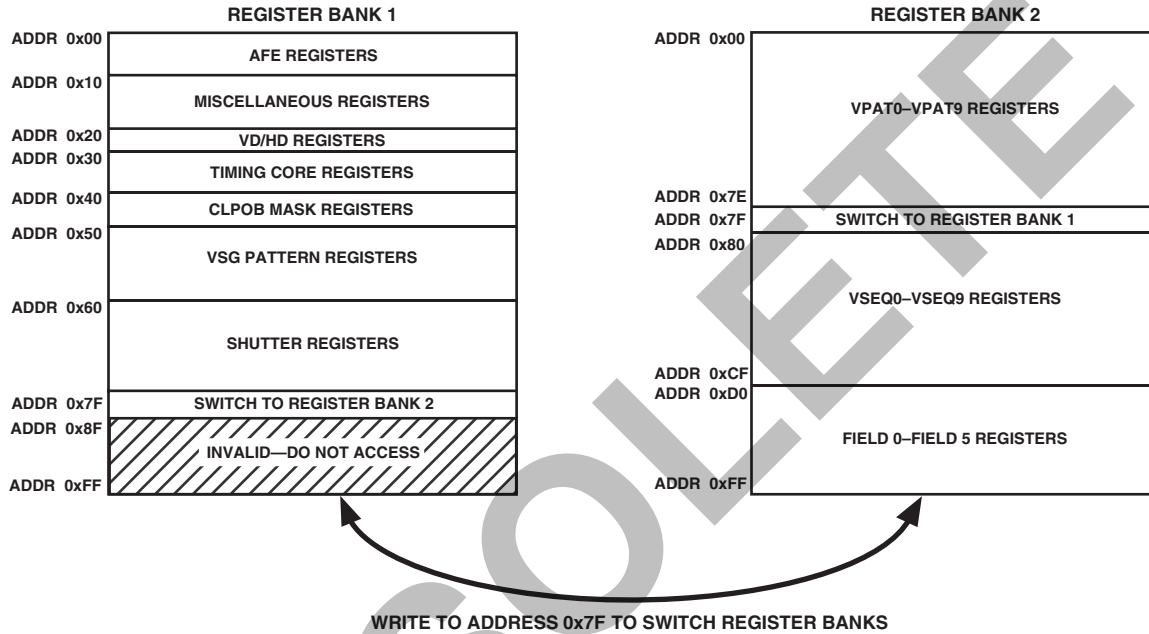

Figure 41. Layout of Internal Register Banks 1 and 2

Updating New Register Values

The AD9995's internal registers are updated at different times, depending on the particular register. Table XV summarizes the four different types of register updates:

1. **SCK Updated:** Some of the registers in Bank 1 are updated immediately, as soon as the 24th data bit (D23) is written. These registers are used for functions that do not require gating with the next VD boundary, such as power-up and reset functions. These registers are lightly shaded in gray in the Bank 1 register list.
The Bank Select register (Addr. 0x7F in Bank 1 and 2) is also SCK updated.
2. **VD Updated:** Most of the registers in Bank 1, as well as the Field registers in Bank 2, are updated at the next VD falling edge. By updating these values at the next VD edge, the current field will not be corrupted and the new register values will be applied to the next field. The Bank 1 register updates may be further delayed past the VD falling edge by using the UPDATE register (Addr. 0x19). This will delay the VD updated register updates to any HD line in the field. Note that the Bank 2 registers are not affected by the UPDATE register.

3. **SG-Line Updated:** A few of the registers in Bank 1 are updated at the end of the SG active line, at the HD falling edge. These are the registers to control the SUBCK signal so that the SUBCK output will not be updated until after the SG line has been completed. These registers are darkly shaded in gray in the Bank 1 register list.
4. **SCP Updated:** In Bank 2, all of the V-pattern group and V-sequence registers (Addr. 0x00 through 0xCF, excluding 0x7F) are updated at the next SCP, where they will be used. For example, in Figure 42, this field has selected Region 1 to use V-Sequence 3 for the vertical outputs. This means that a write to any of the V-Sequence 3 registers, or any of the V-pattern group registers that are referenced by V-Sequence 3 will be updated at SCP1. If multiple writes are done to the same register, the last one done before SCP1 will be the one that is updated. Likewise, register writes to any V-Sequence 5 registers will be updated at SCP2, and register writes to any V-Sequence 8 registers will be updated at SCP3.

Table XV. Register Update Locations

Update Type	Register Bank	Description
SCK Updated	Bank 1 Only	Register is immediately updated when the 24th data bit (D23) is clocked in.
VD Updated	Bank 1 and Bank 2	Register is updated at the VD falling edge. VD updated registers in Bank 1 may be delayed further by using the UPDATE register at Address 0x19 in Bank 1. Bank 2 updates will not be affected by the UPDATE register.
SG Line Updated	Bank 1 Only	Register is updated at the HD falling edge at the end of the SG-active line.
SCP Updated	Bank 2 Only	Register is updated at the next SCP when the register will be used.

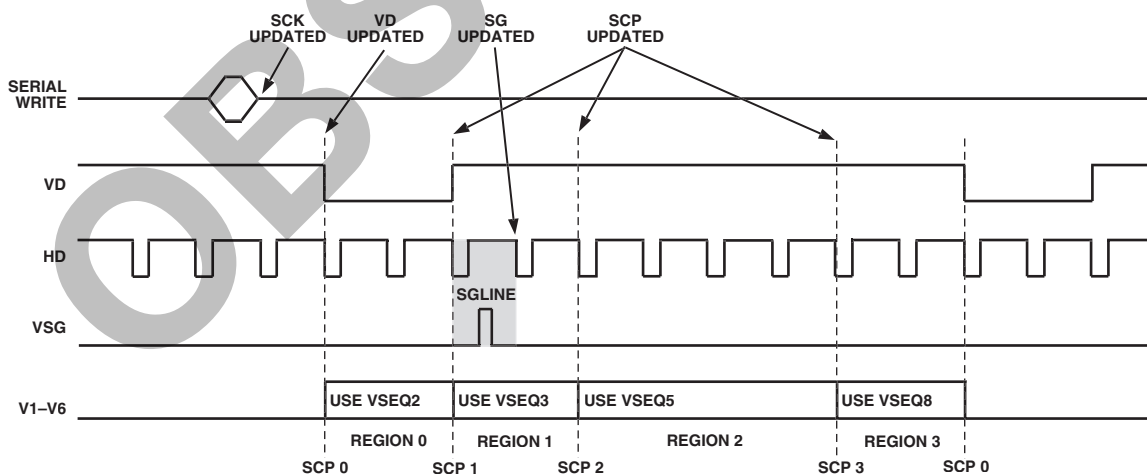

Figure 42. Register Update Locations (See Table XV for Definitions)

AD9995

COMPLETE LISTING FOR REGISTER BANK 1

All registers are VD updated, except where noted: = SCK Updated = SG-Line Updated
 All address and default values are in hexadecimal.

Table XVI. AFE Register Map

Address	Data Bit Content	Default Value	Register Name	Register Description
00	[11:0]	7	OPRMODE	AFE Operation Modes (see Table XXIV for detail).
01	[9:0]	0	VGAGAIN	VGA Gain.
02	[7:0]	80	CLAMPLEVEL	Optical Black Clamp Level.
03	[11:0]	4	CTLMODE	AFE Control Modes (see Table XXV for detail).

Table XVII. Miscellaneous Register Map

Address	Data Bit Content	Default Value	Register Name	Register Description
10	[0]	0	SW_RST	Software Reset. 1 = Reset all registers to default, then self-clear back to 0.
11	[0]	0	OUTCONTROL	Output Control. 0 = Make all outputs dc inactive.
12	[0]	1	TEST USE	Internal Use Only. Must be set to 1.
13	[0]	0	SYNCPOL	SYNC Active Polarity (0 = Active Low).
14	[0]	0	SYNCSUSPEND	Suspend Clocks during SYNC Active (1 = Suspend).
15	[0]	0	TGCORE_RSTB	Timing Core Reset Bar. 0 = Reset TG Core, 1 = Resume Operation.
16	[0]	1	OSC_PWRDOWN	CLO Oscillator Power-Down (0 = Oscillator is powered-down).
17				Unused.
18	[0]	0	TEST USE	Internal Use Only. Must be set to 0.
19	[11:0]	0	UPDATE	Serial Update. Line (HD) in the field to update VD updated registers.
1A	[0]	0	PREVENTUPDATE	Prevents the Update of the VD Updated Registers. 1 = Prevent update.
1B	[23:0]	0	MODE	Mode Register.
1C	[1:0]	0	FIELDVAL	Field Value Sync. 0 = Next Field 0, 1 = Next Field 1, 2/3 = Next Field 2.

Table XVIII. VD/HD Register Map

Address	Data Bit Content	Default Value	Register Name	Register Description
20	[0]	0	MASTER	VD/HD Master or Slave Timing (0 = Slave mode).
21	[0]	0	VDHDPOL	VD/HD Active Polarity. 0 = Low, 1 = High.
22	[17:0]	0	VDHDRISE	Rising Edge Location for VD [17:12] and HD [11:0].

Table XIX. Timing Core Register Map

Address	Data Bit Content	Default Value	Register Name	Register Description
30	[0]	0	CLIDIVIDE	Divide CLI Input Clock by 2. 1 = Divide by 2.
31	[12:0]	01001	H1CONTROL	H1 Signal Control: Polarity [0](0 = Inversion, 1 = No Inversion). H1 Positive Edge Location [6:1]. H1 Negative Edge Location [12:7].
32	[12:0]	01001	H3CONTROL	H3 Signal Control: Polarity [0](0 = Inversion, 1 = No Inversion). H3 Positive Edge Location [6:1]. H3 Negative Edge Location [12:7].
33	[12:0]	00801	RGCONTROL	RG Signal Control: Polarity [0](0 = Inversion, 1 = No Inversion). RG Positive Edge Location [6:1]. RG Negative Edge Location [12:7].
34	[1:0]	0	HBLKRETIME	Retime HBLK to Internal H1/H3 Clocks. H1 Retime [0]. H3 Retime [1]. Preferred setting is 1 for each bit. Setting each bit to 1 will add one cycle delay to HBLK toggle positions.
35	[14:0]	1249	DRVCONTROL	Drive Strength Control for H1 [2:0], H2 [5:3], H3 [8:6], H4 [11:9], and RG [14:12]. Drive Current Values: 0 = Off, 1 = 4.3 mA, 2 = 8.6 mA, 3 = 12.9 mA, 4 = 17.2 mA, 5 = 21.5 mA, 6 = 25.8 mA, 7 = 30.1 mA.
36	[11:0]	00024	SAMPCONTROL	SHP/SHD Sample Control: SHP Sampling Location [5:0]. SHD Sampling Location [11:6].
37	[8:0]	100	DOUTCNTROL	DOUT Phase Control [5:0]. DCLK Mode [6]. DOUTDELAY [8:7].

Table XX. CLPOB Masking Register Map

Address	Data Bit Content	Default Value	Register Name	Register Description
40	[23:0]	FFFFFF	CLPMASK01	CLPOB Line Masking. Line #0 [11:0]. Line #1 [23:0].
41	[23:0]	FFFFFF	CLPMASK23	CLPOB Line Masking. Line #2 [11:0]. Line #3 [23:0].
42	[11:0]	FFFFFF	CLPMASK4	CLPOB Line Masking. Line #4 [11:0].

Table XXI. SG Pattern Register Map

Address	Data Bit Content	Default Value	Register Name	Register Description
50	[3:0]	F	SGPOL	Start Polarity for SG Patterns. Pattern #0 [0]. Pattern #1 [1]. Pattern #2 [2]. Pattern #3 [3].
51	[23:0]	FFFFFF	SGTOG12_0	Pattern #0. Toggle Position 1 [11:0]. Toggle Position 2 [23:12].
52	[23:0]	FFFFFF	SGTOG12_1	Pattern #1. Toggle Position 1 [11:0]. Toggle Position 2 [23:12].
53	[23:0]	FFFFFF	SGTOG12_2	Pattern #2. Toggle Position 1 [11:0]. Toggle Position 2 [23:12].
54	[23:0]	FFFFFF	SGTOG12_3	Pattern #3. Toggle Position 1 [11:0]. Toggle Position 2 [23:12].

Table XXII. Shutter Control Register Map

Address	Data Bit Content	Default Value	Register Name	Register Description
60	[4:0]	0	TRIGGER	Trigger for VSUB [0], MSHUT [1], STROBE [2], Exposure [3], and Readout [4]. Note that to trigger the readout to automatically occur after the exposure period, both exposure and readout should be triggered together.
61	[2:0]	2	READOUT	Number of Fields to Suppress the SUBCK Pulses after the VSG Line.
62	[11:0] [12]	0 0	EXPOSURE VDHDOFF	Number of Fields to Suppress the SUBCK and VSG Pulses. Set = 1 to disable the VD/HD outputs during exposure (when >1 field).
63	[11:0] [23:12]	0 0	SUBCKSUPPRESS SUBCKNUM	Number of SUBCK Pulses to Suppress after VSG Line. Number of SUBCK Pulses per Field.
64	[0]	1	SUBCKPOL	SUBCK Pulse Start Polarity.
65	[23:0]	FFFFFF	SUBCK1TOG	First SUBCK Pulse. Toggle Position 1 [11:0]. Toggle Position 2 [23:0].
66	[23:0]	FFFFFF	SUBCK2TOG	Second SUBCK Pulse. Toggle Position 1 [11:0]. Toggle Position 2 [23:0].

Table XXII. Shutter Control Register Map (continued)

Address	Data Bit Content	Default Value	Register Name	Register Description
67	[1:0]	0	VSUBMODE	VSUB Readout Mode [0]. VSUB Keep-On Mode [1].
68	[12:0]	1000	VSUBON	VSUB ON Position [11:0]. VSUB Active Polarity [12].
69	[1:0]	1	MSHUTPOL	MSHUT Active Polarity [0]. MSHUT Manual Enable [1].
6A	[23:0]	0	MSHUTON	MSHUT ON Position. Line [11:0]. Pixel [23:0].
6B	[11:0]	0	MSHUTOFF_FD	MSHUT OFF Field Position.
6C	[23:0]	0	MSHUTOFF_LNPX	MSHUT OFF Position. Line [11:0]. Pixel [23:12].
6D	[0]	1	STROBPOL	STROBE Active Polarity.
6E	[11:0]	0	STROBON_FD	STROBE ON Field Position.
6F	[23:0]	0	STROBON_LNPX	STROBE ON Position. Line [11:0]. Pixel [23:12].
70	[11:0]	0	STROBOFF_FD	STROBE OFF Field Position.
71	[23:0]	0	STROBOFF_LNPX	STROBE OFF Position. Line [11:0]. Pixel [23:12].

Table XXIII. Register Map Selection

Address	Data Bit Content	Default Value	Register Name	Register Description
7F	[0]	0	BANKSELECT1	Register Bank Access from Bank 1 to Bank 2. 0 = Bank 1, 1 = Bank 2.

Table XXIV. AFE Operation Register Detail

Address	Data Bit Content	Default Value	Register Name	Register Description
00	[1:0]	3	PWRDOWN	0 = Normal Operation, 1 = Standby 1, 2 = Standby 2, 3 = Standby 3.
	[2]	1	CLPENABLE	0 = Disable OB Clamp, 1 = Enable OB Clamp.
	[3]	0	CLPSPEED	0 = Select Normal OB Clamp Settling, 1 = Select Fast OB Clamp Settling.
	[4]	0	TEST	Test Use Only. Set to 0.
	[5]	0	PBLK_LVL	DOUT Value during PBLK: 0 = Blank to Zero, 1 = Blank to Clamp Level.
	[7:6]	0	TEST	Test Use Only. Set to 0.
	[8]	0	DCBYP	0 = Enable DC Restore Circuit, 1 = Bypass DC Restore Circuit during PBLK.
	[9]	0	TEST	Test Use Only. Set to 0.

Table XXV. AFE Control Register Detail

Address	Data Bit Content	Default Value	Register Name	Register Description
03	[1:0]	0	TEST	Test Use Only. Set to 00.
	[2]	1	TEST	Test Use Only. Set to 1.
	[3]	0	DOUTDISABLE	0 = Data Outputs are Driven, 1 = Data Outputs are Three-Stated.
	[4]	0	DOUTLATCH	0 = Latch Data Outputs with DOUT Phase, 1 = Output Latch Transparent.
	[5]	0	GRAYENCODE	0 = Binary Encode Data Outputs, 1 = Gray Encode Data Outputs.

COMPLETE LISTING FOR REGISTER BANK 2

All V-pattern group and V-sequence registers are SCP updated, and all Field registers are VD updated.

All address and default values are in hexadecimal.

Table XXVI. V-Pattern Group 0 (VPAT0) Register Map

Address	Data Bit Content	Default Value	Register Name	Description
00	[5:0]	0	VPOL_0	VPAT0 Start Polarity. V1[0]. V2[1]. V3[2]. V4[3]. V5[4]. V6[5].
	[11:6]	0	UNUSED	Unused.
	[23:12]	0	VPATLEN_0	Total Length of VPAT0. Note: If using VPAT0 as a second V-sequence in the VSG active line, this value is the start position for the second V-sequence.
01	[11:0]	0	V1TOG1_0	V1 Toggle Position 1
	[23:12]	0	V1TOG2_0	V1 Toggle Position 2
02	[11:0]	0	V1TOG3_0	V1 Toggle Position 3
	[23:12]	0	V2TOG1_0	V2 Toggle Position 1
03	[11:0]	0	V2TOG2_0	V2 Toggle Position 2
	[23:12]	0	V2TOG3_0	V2 Toggle Position 3
04	[11:0]	0	V3TOG1_0	V3 Toggle Position 1
	[23:12]	0	V3TOG2_0	V3 Toggle Position 2
05	[11:0]	0	V3TOG3_0	V3 Toggle Position 3
	[23:12]	0	V4TOG1_0	V4 Toggle Position 1
06	[11:0]	0	V4TOG2_0	V4 Toggle Position 2
	[23:12]	0	V4TOG3_0	V4 Toggle Position 3
07	[11:0]	0	V5TOG1_0	V5 Toggle Position 1
	[23:12]	0	V5TOG2_0	V5 Toggle Position 2
08	[11:0]	0	V5TOG3_0	V5 Toggle Position 3
	[23:12]	0	V6TOG1_0	V6 Toggle Position 1
09	[11:0]	0	V6TOG2_0	V6 Toggle Position 2
	[23:12]	0	V6TOG3_0	V6 Toggle Position 3
0A	[11:0]	0	FREEZE1_0	V1–V6 Freeze Position 1
	[23:12]	0	RESUME1_0	V1–V6 Resume Position 1
0B	[11:0]	0	FREEZE2_0	V1–V6 Freeze Position 2
	[23:12]	0	RESUME2_0	V1–V6 Resume Position 2

Table XXVII. V-Pattern Group 1 (VPAT1) Register Map

Address	Data Bit Content	Default Value	Register Name	Description
0C	[5:0]	0	VPOL_1	VPAT1 Start Polarity. V1[0]. V2[1]. V3[2]. V4[3]. V5[4]. V6[5].
	[11:6]	0	UNUSED	Unused.
	[23:12]	0	VPATLEN_1	Total Length of VPAT1. Note: If using VPAT1 as a second V-sequence in the VSG active line, this value is the start position for the second V-sequence.
0D	[11:0]	0	V1TOG1_1	V1 Toggle Position 1
	[23:12]	0	V1TOG2_1	V1 Toggle Position 2
0E	[11:0]	0	V1TOG3_1	V1 Toggle Position 3
	[23:12]	0	V2TOG1_1	V2 Toggle Position 1
0F	[11:0]	0	V2TOG2_1	V2 Toggle Position 2
	[23:12]	0	V2TOG3_1	V2 Toggle Position 3
10	[11:0]	0	V3TOG1_1	V3 Toggle Position 1
	[23:12]	0	V3TOG2_1	V3 Toggle Position 2
11	[11:0]	0	V3TOG3_1	V3 Toggle Position 3
	[23:12]	0	V4TOG1_1	V4 Toggle Position 1
12	[11:0]	0	V4TOG2_1	V4 Toggle Position 2
	[23:12]	0	V4TOG3_1	V4 Toggle Position 3

Table XXVII. V-Pattern Group 1 (VPAT1) Register Map (continued)

Address	Data Bit Content	Default Value	Register Name	Description
13	[11:0]	0	V5TOG1_1	V5 Toggle Position 1
	[23:12]	0	V5TOG2_1	V5 Toggle Position 2
14	[11:0]	0	V5TOG3_1	V5 Toggle Position 3
	[23:12]	0	V6TOG1_1	V6 Toggle Position 1
15	[11:0]	0	V6TOG2_1	V6 Toggle Position 2
	[23:12]	0	V6TOG3_1	V6 Toggle Position 3
16	[11:0]	0	FREEZE1_1	V1–V6 Freeze Position 1
	[23:12]	0	RESUME1_1	V1–V6 Resume Position 1
17	[11:0]	0	FREEZE2_1	V1–V6 Freeze Position 2
	[23:12]	0	RESUME2_1	V1–V6 Resume Position 2

Table XXVIII. V-Pattern Group 2 (VPAT2) Register Map

Address	Data Bit Content	Default Value	Register Name	Description
18	[5:0]	0	VPOL_2	VPAT2 Start Polarity. V1[0]. V2[1]. V3[2]. V4[3]. V5[4]. V6[5].
	[11:6]	0	UNUSED	Unused.
	[23:12]	0	VPATLEN_2	Total Length of VPAT2. Note: If using VPAT2 as a second V-sequence in the VSG active line, this value is the start position for the second V-sequence.
19	[11:0]	0	V1TOG1_2	V1 Toggle Position 1
	[23:12]	0	V1TOG2_2	V1 Toggle Position 2
1A	[11:0]	0	V1TOG3_2	V1 Toggle Position 3
	[23:12]	0	V2TOG1_2	V2 Toggle Position 1
1B	[11:0]	0	V2TOG2_2	V2 Toggle Position 2
	[23:12]	0	V2TOG3_2	V2 Toggle Position 3
1C	[11:0]	0	V3TOG1_2	V3 Toggle Position 1
	[23:12]	0	V3TOG2_2	V3 Toggle Position 2
1D	[11:0]	0	V3TOG3_2	V3 Toggle Position 3
	[23:12]	0	V4TOG1_2	V4 Toggle Position 1
1E	[11:0]	0	V4TOG2_2	V4 Toggle Position 2
	[23:12]	0	V4TOG3_2	V4 Toggle Position 3
1F	[11:0]	0	V5TOG1_2	V5 Toggle Position 1
	[23:12]	0	V5TOG2_2	V5 Toggle Position 2
20	[11:0]	0	V5TOG3_2	V5 Toggle Position 3
	[23:12]	0	V6TOG1_2	V6 Toggle Position 1
21	[11:0]	0	V6TOG2_2	V6 Toggle Position 2
	[23:12]	0	V6TOG3_2	V6 Toggle Position 3
22	[11:0]	0	FREEZE1_2	V1–V6 Freeze Position 1
	[23:12]	0	RESUME1_2	V1–V6 Resume Position 1
23	[11:0]	0	FREEZE2_2	V1–V6 Freeze Position 2
	[23:12]	0	RESUME2_2	V1–V6 Resume Position 2

Table XXIX. V-Pattern Group 3 (VPAT3) Register Map

Address	Data Bit Content	Default Value	Register Name	Description
24	[5:0]	0	VPOL_3	VPAT3 Start Polarity. V1[0]. V2[1]. V3[2]. V4[3]. V5[4]. V6[5].
	[11:6]	0	UNUSED	Unused.
	[23:12]	0	VPATLEN_3	Total Length of VPAT3. Note: If using VPAT3 as a second V-sequence in the VSG active line, this value is the start position for the second V-sequence.
25	[11:0]	0	V1TOG1_3	V1 Toggle Position 1
	[23:12]	0	V1TOG2_3	V1 Toggle Position 2

Table XXIX. V-Pattern Group 3 (VPAT3) Register Map (continued)

Address	Data Bit Content	Default Value	Register Name	Description
26	[11:0]	0	V1TOG3_3	V1 Toggle Position 3
	[23:12]	0	V2TOG1_3	V2 Toggle Position 1
27	[11:0]	0	V2TOG2_3	V2 Toggle Position 2
	[23:12]	0	V2TOG3_3	V2 Toggle Position 3
28	[11:0]	0	V3TOG1_3	V3 Toggle Position 1
	[23:12]	0	V3TOG2_3	V3 Toggle Position 2
29	[11:0]	0	V3TOG3_3	V3Toggle Position 3
	[23:12]	0	V4TOG1_3	V4 Toggle Position 1
2A	[11:0]	0	V4TOG2_3	V4 Toggle Position 2
	[23:12]	0	V4TOG3_3	V4 Toggle Position 3
2B	[11:0]	0	V5TOG1_3	V5 Toggle Position 1
	[23:12]	0	V5TOG2_3	V5 Toggle Position 2
2C	[11:0]	0	V5TOG3_3	V5 Toggle Position 3
	[23:12]	0	V6TOG1_3	V6 Toggle Position 1
2D	[11:0]	0	V6TOG2_3	V6 Toggle Position 2
	[23:12]	0	V6TOG3_3	V6 Toggle Position 3
2E	[11:0]	0	FREEZE1_3	V1–V6 Freeze Position 1
	[23:12]	0	RESUME1_3	V1–V6 Resume Position 1
2F	[11:0]	0	FREEZE2_3	V1–V6 Freeze Position 2
	[23:12]	0	RESUME2_3	V1–V6 Resume Position 2

Table XXX. V-Pattern Group 4 (VPAT4) Register Map

Address	Data Bit Content	Default Value	Register Name	Description
30	[5:0]	0	VPOL_4	VPAT4 Start Polarity. V1[0]. V2[1]. V3[2]. V4[3]. V5[4]. V6[5].
	[11:6]	0	UNUSED	Unused.
	[23:12]	0	VPATLEN_4	Total Length of VPAT4. Note: If using VPAT4 as a second V-sequence in the VSG active line, this value is the start position for the second V-sequence.
31	[11:0]	0	V1TOG1_4	V1 Toggle Position 1
	[23:12]	0	V1TOG2_4	V1 Toggle Position 2
32	[11:0]	0	V1TOG3_4	V1 Toggle Position 3
	[23:12]	0	V2TOG1_4	V2 Toggle Position 1
33	[11:0]	0	V2TOG2_4	V2 Toggle Position 2
	[23:12]	0	V2TOG3_4	V2 Toggle Position 3
34	[11:0]	0	V3TOG1_4	V3 Toggle Position 1
	[23:12]	0	V3TOG2_4	V3 Toggle Position 2
35	[11:0]	0	V3TOG3_4	V3Toggle Position 3
	[23:12]	0	V4TOG1_4	V4 Toggle Position 1
36	[11:0]	0	V4TOG2_4	V4 Toggle Position 2
	[23:12]	0	V4TOG3_4	V4 Toggle Position 3
37	[11:0]	0	V5TOG1_4	V5 Toggle Position 1
	[23:12]	0	V5TOG2_4	V5 Toggle Position 2
38	[11:0]	0	V5TOG3_4	V5 Toggle Position 3
	[23:12]	0	V6TOG1_4	V6 Toggle Position 1
39	[11:0]	0	V6TOG2_4	V6 Toggle Position 2
	[23:12]	0	V6TOG3_4	V6 Toggle Position 3
3A	[11:0]	0	FREEZE1_4	V1–V6 Freeze Position 1
	[23:12]	0	RESUME1_4	V1–V6 Resume Position 1
3B	[11:0]	0	FREEZE2_4	V1–V6 Freeze Position 2
	[23:12]	0	RESUME2_4	V1–V6 Resume Position 2

Table XXXI. V-Pattern Group 5 (VPAT5) Register Map

Address	Data Bit Content	Default Value	Register Name	Description
3C	[5:0]	0	VPOL_5	VPAT5 Start Polarity. V1[0]. V2[1]. V3[2]. V4[3]. V5[4]. V6[5].
	[11:6]	0	UNUSED	Unused.
	[23:12]	0	VPATLEN_5	Total Length of VPAT5. Note: If using VPAT5 as a second V-sequence in the VSG active line, this value is the start position for the second V-sequence.
3D	[11:0]	0	V1TOG1_5	V1 Toggle Position 1
	[23:12]	0	V1TOG2_5	V1 Toggle Position 2
3E	[11:0]	0	V1TOG3_5	V1 Toggle Position 3
	[23:12]	0	V2TOG1_5	V2 Toggle Position 1
3F	[11:0]	0	V2TOG2_5	V2 Toggle Position 2
	[23:12]	0	V2TOG3_5	V2 Toggle Position 3
40	[11:0]	0	V3TOG1_5	V3 Toggle Position 1
	[23:12]	0	V3TOG2_5	V3 Toggle Position 2
41	[11:0]	0	V3TOG3_5	V3 Toggle Position 3
	[23:12]	0	V4TOG1_5	V4 Toggle Position 1
42	[11:0]	0	V4TOG2_5	V4 Toggle Position 2
	[23:12]	0	V4TOG3_5	V4 Toggle Position 3
43	[11:0]	0	V5TOG1_5	V5 Toggle Position 1
	[23:12]	0	V5TOG2_5	V5 Toggle Position 2
44	[11:0]	0	V5TOG3_5	V5 Toggle Position 3
	[23:12]	0	V6TOG1_5	V6 Toggle Position 1
45	[11:0]	0	V6TOG2_5	V6 Toggle Position 2
	[23:12]	0	V6TOG3_5	V6 Toggle Position 3
46	[11:0]	0	FREEZE1_5	V1–V6 Freeze Position 1
	[23:12]	0	RESUME1_5	V1–V6 Resume Position 1
47	[11:0]	0	FREEZE2_5	V1–V6 Freeze Position 2
	[23:12]	0	RESUME2_5	V1–V6 Resume Position 2

Table XXXII. V-Pattern Group 6 (VPAT6) Register Map

Address	Data Bit Content	Default Value	Register Name	Description
48	[5:0]	0	VPOL_6	VPAT6 Start Polarity. V1[0]. V2[1]. V3[2]. V4[3]. V5[4]. V6[5].
	[11:6]	0	UNUSED	Unused.
	[23:12]	0	VPATLEN_6	Total Length of VPAT6. Note: If using VPAT6 as a second V-sequence in the VSG active line, this value is the start position for the second V-sequence.
49	[11:0]	0	V1TOG1_6	V1 Toggle Position 1
	[23:12]	0	V1TOG2_6	V1 Toggle Position 2
4A	[11:0]	0	V1TOG3_6	V1 Toggle Position 3
	[23:12]	0	V2TOG1_6	V2 Toggle Position 1
4B	[11:0]	0	V2TOG2_6	V2 Toggle Position 2
	[23:12]	0	V2TOG3_6	V2 Toggle Position 3
4C	[11:0]	0	V3TOG1_6	V3 Toggle Position 1
	[23:12]	0	V3TOG2_6	V3 Toggle Position 2
4D	[11:0]	0	V3TOG3_6	V3 Toggle Position 3
	[23:12]	0	V4TOG1_6	V4 Toggle Position 1
4E	[11:0]	0	V4TOG2_6	V4 Toggle Position 2
	[23:12]	0	V4TOG3_6	V4 Toggle Position 3
4F	[11:0]	0	V5TOG1_6	V5 Toggle Position 1
	[23:12]	0	V5TOG2_6	V5 Toggle Position 2

Table XXXII. V-Pattern Group 6 (VPAT6) Register Map (continued)

Address	Data Bit Content	Default Value	Register Name	Description
50	[11:0]	0	V5TOG3_6	V5 Toggle Position 3
	[23:12]	0	V6TOG1_6	V6 Toggle Position 1
51	[11:0]	0	V6TOG2_6	V6 Toggle Position 2
	[23:12]	0	V6TOG3_6	V6 Toggle Position 3
52	[11:0]	0	FREEZE1_6	V1–V6 Freeze Position 1
	[23:12]	0	RESUME1_6	V1–V6 Resume Position 1
53	[11:0]	0	FREEZE2_6	V1–V6 Freeze Position 2
	[23:12]	0	RESUME2_6	V1–V6 Resume Position 2

Table XXXIII. V-Pattern Group 7 (VPAT7) Register Map

Address	Data Bit Content	Default Value	Register Name	Description
54	[5:0]	0	VPOL_7	VPAT7 Start Polarity. V1[0]. V2[1]. V3[2]. V4[3]. V5[4]. V6[5].
	[11:6]	0	UNUSED	Unused.
	[23:12]	0	VPATLEN_7	Total Length of VPAT7. Note: If using VPAT7 as a second V-sequence in the VSG active line, this value is the start position for the second V-sequence.
55	[11:0]	0	V1TOG1_7	V1 Toggle Position 1
	[23:12]	0	V1TOG2_7	V1 Toggle Position 2
56	[11:0]	0	V1TOG3_7	V1 Toggle Position 3
	[23:12]	0	V2TOG1_7	V2 Toggle Position 1
57	[11:0]	0	V2TOG2_7	V2 Toggle Position 2
	[23:12]	0	V2TOG3_7	V2 Toggle Position 3
58	[11:0]	0	V3TOG1_7	V3 Toggle Position 1
	[23:12]	0	V3TOG2_7	V3 Toggle Position 2
59	[11:0]	0	V3TOG3_7	V3 Toggle Position 3
	[23:12]	0	V4TOG1_7	V4 Toggle Position 1
5A	[11:0]	0	V4TOG2_7	V4 Toggle Position 2
	[23:12]	0	V4TOG3_7	V4 Toggle Position 3
5B	[11:0]	0	V5TOG1_7	V5 Toggle Position 1
	[23:12]	0	V5TOG2_7	V5 Toggle Position 2
5C	[11:0]	0	V5TOG3_7	V5 Toggle Position 3
	[23:12]	0	V6TOG1_7	V6 Toggle Position 1
5D	[11:0]	0	V6TOG2_7	V6 Toggle Position 2
	[23:12]	0	V6TOG3_7	V6 Toggle Position 3
5E	[11:0]	0	FREEZE1_7	V1–V6 Freeze Position 1
	[23:12]	0	RESUME1_7	V1–V6 Resume Position 1
5F	[11:0]	0	FREEZE2_7	V1–V6 Freeze Position 2
	[23:12]	0	RESUME2_7	V1–V6 Resume Position 2

Table XXXIV. V-Pattern Group 8 (VPAT8) Register Map

Address	Data Bit Content	Default Value	Register Name	Description
60	[5:0]	0	VPOL_8	VPAT8 Start Polarity. V1[0]. V2[1]. V3[2]. V4[3]. V5[4]. V6[5].
	[11:6]	0	UNUSED	Unused.
	[23:12]	0	VPATLEN_8	Total Length of VPAT8. Note: If using VPAT8 as a second V-sequence in the VSG active line, this value is the start position for the second V-sequence.
61	[11:0]	0	V1TOG1_8	V1 Toggle Position 1
	[23:12]	0	V1TOG2_8	V1 Toggle Position 2
62	[11:0]	0	V1TOG3_8	V1 Toggle Position 3
	[23:12]	0	V1TOG4_8	V1 Toggle Position 4

AD9995

Table XXXIV. V-Pattern Group 8 (VPAT8) Register Map (continued)

Address	Data Bit Content	Default Value	Register Name	Description
63	[11:0]	0	V2TOG1_8	V2 Toggle Position 1
	[23:12]	0	V2TOG2_8	V2 Toggle Position 2
64	[11:0]	0	V3TOG3_8	V2 Toggle Position 3
	[23:12]	0	V3TOG4_8	V2 Toggle Position 4
65	[11:0]	0	V3TOG1_8	V3 Toggle Position 1
	[23:12]	0	V4TOG2_8	V3 Toggle Position 2
66	[11:0]	0	V4TOG3_8	V3 Toggle Position 3
	[23:12]	0	V4TOG4_8	V3 Toggle Position 4
67	[11:0]	0	V5TOG1_8	V4 Toggle Position 1
	[23:12]	0	V5TOG2_8	V4 Toggle Position 2
68	[11:0]	0	V5TOG3_8	V4 Toggle Position 3
	[23:12]	0	V6TOG4_8	V4 Toggle Position 4
69	[11:0]	0	V6TOG1_8	V5 Toggle Position 1
	[23:12]	0	V6TOG2_8	V5 Toggle Position 2
6A	[11:0]	0	V6TOG3_8	V5 Toggle Position 3
	[23:12]	0	V6TOG4_8	V5 Toggle Position 4
6B	[11:0]	0	V6TOG1_8	V6 Toggle Position 1
	[23:12]	0	V6TOG2_8	V6 Toggle Position 2
6C	[11:0]	0	V6TOG3_8	V6 Toggle Position 3
	[23:12]	0	V6TOG4_8	V6 Toggle Position 4
6D	[11:0]	0	FREEZE1_8	V1–V6 Freeze Position 1
	[23:12]	0	RESUME1_8	V1–V6 Resume Position 1
6E	[11:0]	0	FREEZE2_8	V1–V6 Freeze Position 2
	[23:12]	0	RESUME2_8	V1–V6 Resume Position 2
6F			UNUSED	Unused

Table XXXV. V-Pattern Group 9 (VPAT9) Register Map

Address	Data Bit Content	Default Value	Register Name	Description
70	[5:0]	0	VPOL_9	VPAT9 Start Polarity. V1[0]. V2[1]. V3[2]. V4[3]. V5[4]. V6[5].
	[11:6]	0	UNUSED	Unused.
	[23:12]	0	VPATLEN_9	Total Length of VPAT9. Note: If using VPAT9 as a second V-sequence in the VSG active line, this value is the start position for the second V-sequence.
71	[11:0]	0	V1TOG1_9	V1 Toggle Position 1
	[23:12]	0	V1TOG2_9	V1 Toggle Position 2
72	[11:0]	0	V1TOG3_9	V1 Toggle Position 3
	[23:12]	0	V1TOG4_9	V1 Toggle Position 4
73	[11:0]	0	V2TOG1_9	V2 Toggle Position 1
	[23:12]	0	V2TOG2_9	V2 Toggle Position 2
74	[11:0]	0	V3TOG3_9	V2 Toggle Position 3
	[23:12]	0	V3TOG4_9	V2 Toggle Position 4
75	[11:0]	0	V3TOG1_9	V3 Toggle Position 1
	[23:12]	0	V4TOG2_9	V3 Toggle Position 2
76	[11:0]	0	V4TOG3_9	V3 Toggle Position 3
	[23:12]	0	V4TOG4_9	V3 Toggle Position 4
77	[11:0]	0	V5TOG1_9	V4 Toggle Position 1
	[23:12]	0	V5TOG2_9	V4 Toggle Position 2
78	[11:0]	0	V5TOG3_9	V4 Toggle Position 3
	[23:12]	0	V6TOG4_9	V4 Toggle Position 4

Table XXXV. V-Pattern Group 9 (VPAT9) Register Map (continued)

Address	Data Bit Content	Default Value	Register Name	Description
79	[11:0] [23:12]	0 0	V6TOG1_9 V6TOG2_9	V5 Toggle Position 1 V5 Toggle Position 2
7A	[11:0] [23:12]	0 0	V6TOG3_9 V6TOG4_9	V5 Toggle Position 3 V5 Toggle Position 4
7B	[11:0] [23:12]	0 0	V6TOG1_9 V6TOG2_9	V6 Toggle Position 1 V6 Toggle Position 2
7C	[11:0] [23:12]	0 0	V6TOG3_9 V6TOG4_9	V6 Toggle Position 3 V6 Toggle Position 4
7D	[11:0] [23:12]	0 0	FREEZE1_9 RESUME1_9	V1–V6 Freeze Position 1 V1–V6 Resume Position 1
7E	[11:0] [23:12]	0 0	FREEZE2_9 RESUME2_9	V1–V6 Freeze Position 2 V1–V6 Resume Position 2

Table XXXVI. Register Map Selection (SCK Updated Register)

Address	Data Bit Content	Default Value	Register Name	Register Description
7F	[0]	0	BANKSELECT2	Register Bank Access from Bank 2 to Bank 1. 0 = Bank 1, 1 = Bank 2.

Table XXXVII. V-Sequence 0 (VSEQ0) Register Map

Address	Data Bit Content	Default Value	Register Name	Description
80	[1:0] [2] [3] [7:4] [9:8] [11:10] [23:12]	0 0 0 0 0 0 0	HBLKMASK_0 CLPOBPOL_0 PBLKPOL_0 VPATSEL_0 VMASK_0 HBLKALT_0 UNUSED	Masking Polarity during HBLK. H1 [0]. H3 [1]. CLPOB Start Polarity PBLK Start Polarity Selected V-Pattern Group for V-Sequence 0 Enable Masking of V-Outputs (Specified by FREEZE/RESUME Registers) Enable HBLK Alternation Unused
81	[11:0] [23:12]	0 0	VPATREPO_0 VPATREPE_0	Number of Selected V-Pattern Group Repetitions for Odd Lines Number of Selected V-Pattern Group Repetitions for Even Lines
82	[11:0] [23:12]	0 0	VPATSTART_0 HDLEN_0	Start Position in the Line for the Selected V-Pattern Group HD Line Length (Number of Pixels) for V-Sequence 0
83	[11:0] [23:12]	0 0	PBLKTOG1_0 PBLKTOG2_0	PBLK Toggle Position 1 for V-Sequence 0 PBLK Toggle Position 2 for V-Sequence 0
84	[11:0] [23:12]	0 0	HBLKTOG1_0 HBLKTOG2_0	HBLK Toggle Position 1 for V-Sequence 0 HBLK Toggle Position 2 for V-Sequence 0
85	[11:0] [23:12]	0 0	HBLKTOG3_0 HBLKTOG4_0	HBLK Toggle Position 3 for V-Sequence 0 HBLK Toggle Position 4 for V-Sequence 0
86	[11:0] [23:12]	0 0	HBLKTOG5_0 HBLKTOG6_0	HBLK Toggle Position 5 for V-Sequence 0 HBLK Toggle Position 6 for V-Sequence 0
87	[11:0] [23:12]	0 0	CLPOBTOG1_0 CLPOBTOG2_0	CLPOB Toggle Position 1 for V-Sequence 0 CLPOB Toggle Position 2 for V-Sequence 0

Table XXXVIII. V-Sequence 1 (VSEQ1) Register Map

Address	Data Bit Content	Default Value	Register Name	Description
88	[1:0]	0	HBLKMASK_1	Masking Polarity during HBLK. H1 [0]. H3 [1].
	[2]	0	CLPOBPOL_1	CLPOB Start Polarity
	[3]	0	PBLKPOL_1	PBLK Start Polarity
	[7:4]	0	VPATSEL_1	Selected V-Pattern Group for V-Sequence 1
	[9:8]	0	VMASK_1	Enable Masking of V-Outputs (Specified by FREEZE/RESUME Registers)
	[11:10]	0	HBLKALT_1	Enable HBLK Alternation
	[23:12]	0	UNUSED	Unused
89	[11:0]	0	VPATREPO_1	Number of Selected V-Pattern Group Repetitions for Odd Lines
	[23:12]	0	VPATREPE_1	Number of Selected V-Pattern Group Repetitions for Even Lines
8A	[11:0]	0	VPATSTART_1	Start Position in the Line for the Selected V-Pattern Group
	[23:12]	0	HDLEN_1	HD Line Length (Number of Pixels) for V-Sequence 1
8B	[11:0]	0	PBLKTOG1_1	PBLK Toggle Position 1 for V-Sequence 1
	[23:12]	0	PBLKTOG2_1	PBLK Toggle Position 2 for V-Sequence 1
8C	[11:0]	0	HBLKTOG1_1	HBLK Toggle Position 1 for V-Sequence 1
	[23:12]	0	HBLKTOG2_1	HBLK Toggle Position 2 for V-Sequence 1
8D	[11:0]	0	HBLKTOG3_1	HBLK Toggle Position 3 for V-Sequence 1
	[23:12]	0	HBLKTOG4_1	HBLK Toggle Position 4 for V-Sequence 1
8E	[11:0]	0	HBLKTOG5_1	HBLK Toggle Position 5 for V-Sequence 1
	[23:12]	0	HBLKTOG6_1	HBLK Toggle Position 6 for V-Sequence 1
8F	[11:0]	0	CLPOBTOG1_1	CLPOB Toggle Position 1 for V-Sequence 1
	[23:12]	0	CLPOBTOG2_1	CLPOB Toggle Position 2 for V-Sequence 1

Table XXXIX. V-Sequence 2 (VSEQ2) Register Map

Address	Data Bit Content	Default Value	Register Name	Description
90	[1:0]	0	HBLKMASK_2	Masking Polarity during HBLK. H1 [0]. H3 [1].
	[2]	0	CLPOBPOL_2	CLPOB Start Polarity
	[3]	0	PBLKPOL_2	PBLK Start Polarity
	[7:4]	0	VPATSEL_2	Selected V-Pattern Group for V-Sequence 2
	[9:8]	0	VMASK_2	Enable Masking of V-Outputs (Specified by FREEZE/RESUME Registers)
	[11:10]	0	HBLKALT_2	Enable HBLK Alternation
	[23:12]	0	UNUSED	Unused
91	[11:0]	0	VPATREPO_2	Number of Selected V-Pattern Group Repetitions for Odd Lines
	[23:12]	0	VPATREPE_2	Number of Selected V-Pattern Group Repetitions for Even Lines
92	[11:0]	0	VPATSTART_2	Start Position in the Line for the Selected V-Pattern Group
	[23:12]	0	HDLEN_2	HD Line Length (Number of Pixels) for V-Sequence 2
93	[11:0]	0	PBLKTOG1_2	PBLK Toggle Position 1 for V-Sequence 2
	[23:12]	0	PBLKTOG2_2	PBLK Toggle Position 2 for V-Sequence 2
94	[11:0]	0	HBLKTOG1_2	HBLK Toggle Position 1 for V-Sequence 2
	[23:12]	0	HBLKTOG2_2	HBLK Toggle Position 2 for V-Sequence 2
95	[11:0]	0	HBLKTOG3_2	HBLK Toggle Position 3 for V-Sequence 2
	[23:12]	0	HBLKTOG4_2	HBLK Toggle Position 4 for V-Sequence 2
96	[11:0]	0	HBLKTOG5_2	HBLK Toggle Position 5 for V-Sequence 2
	[23:12]	0	HBLKTOG6_2	HBLK Toggle Position 6 for V-Sequence 2
97	[11:0]	0	CLPOBTOG1_2	CLPOB Toggle Position 1 for V-Sequence 2
	[23:12]	0	CLPOBTOG2_2	CLPOB Toggle Position 2 for V-Sequence 2

Table XL. V-Sequence 3 (VSEQ3) Register Map

Address	Data Bit Content	Default Value	Register Name	Description
98	[1:0]	0	HBLKMASK_3	Masking Polarity during HBLK. H1 [0]. H3 [1].
	[2]	0	CLPOBPOL_3	CLPOB Start Polarity
	[3]	0	PBLKPOL_3	PBLK Start Polarity
	[7:4]	0	VPATSEL_3	Selected V-Pattern Group for V-Sequence 3
	[9:8]	0	VMASK_3	Enable Masking of V-Outputs (Specified by FREEZE/RESUME Registers)
	[11:10]	0	HBLKALT_3	Enable HBLK Alternation
	[23:12]	0	UNUSED	Unused
99	[11:0]	0	VPATREPO_3	Number of Selected V-Pattern Group Repetitions for Odd Lines
	[23:12]	0	VPATREPE_3	Number of Selected V-Pattern Group Repetitions for Even Lines
9A	[11:0]	0	VPATSTART_3	Start Position in the Line for the Selected V-Pattern Group
	[23:12]	0	HDLEN_3	HD Line Length (Number of Pixels) for V-Sequence 3
9B	[11:0]	0	PBLKTOG1_3	PBLK Toggle Position 1 for V-Sequence 3
	[23:12]	0	PBLKTOG2_3	PBLK Toggle Position 2 for V-Sequence 3
9C	[11:0]	0	HBLKTOG1_3	HBLK Toggle Position 1 for V-Sequence 3
	[23:12]	0	HBLKTOG2_3	HBLK Toggle Position 2 for V-Sequence 3
9D	[11:0]	0	HBLKTOG3_3	HBLK Toggle Position 3 for V-Sequence 3
	[23:12]	0	HBLKTOG4_3	HBLK Toggle Position 4 for V-Sequence 3
9E	[11:0]	0	HBLKTOG5_3	HBLK Toggle Position 5 for V-Sequence 3
	[23:12]	0	HBLKTOG6_3	HBLK Toggle Position 6 for V-Sequence 3
9F	[11:0]	0	CLPOBTOG1_3	CLPOB Toggle Position 1 for V-Sequence 3
	[23:12]	0	CLPOBTOG2_3	CLPOB Toggle Position 2 for V-Sequence 3

Table XLI. V-Sequence 4 (VSEQ4) Register Map

Address	Data Bit Content	Default Value	Register Name	Description
A0	[1:0]	0	HBLKMASK_4	Masking Polarity during HBLK. H1 [0]. H3 [1].
	[2]	0	CLPOBPOL_4	CLPOB Start Polarity
	[3]	0	PBLKPOL_4	PBLK Start Polarity
	[7:4]	0	VPATSEL_4	Selected V-Pattern Group for V-Sequence 4
	[9:8]	0	VMASK_4	Enable Masking of V-Outputs (Specified by FREEZE/RESUME Registers)
	[11:10]	0	HBLKALT_4	Enable HBLK Alternation
	[23:12]	0	UNUSED	Unused
A1	[11:0]	0	VPATREPO_4	Number of Selected V-Pattern Group Repetitions for Odd Lines
	[23:12]	0	VPATREPE_4	Number of Selected V-Pattern Group Repetitions for Even Lines
A2	[11:0]	0	VPATSTART_4	Start Position in the Line for the Selected V-Pattern Group
	[23:12]	0	HDLEN_4	HD Line Length (Number of Pixels) for V-Sequence 4
A3	[11:0]	0	PBLKTOG1_4	PBLK Toggle Position 1 for V-Sequence 4
	[23:12]	0	PBLKTOG2_4	PBLK Toggle Position 2 for V-Sequence 4
A4	[11:0]	0	HBLKTOG1_4	HBLK Toggle Position 1 for V-Sequence 4
	[23:12]	0	HBLKTOG2_4	HBLK Toggle Position 2 for V-Sequence 4
A5	[11:0]	0	HBLKTOG3_4	HBLK Toggle Position 3 for V-Sequence 4
	[23:12]	0	HBLKTOG4_4	HBLK Toggle Position 4 for V-Sequence 4
A6	[11:0]	0	HBLKTOG5_4	HBLK Toggle Position 5 for V-Sequence 4
	[23:12]	0	HBLKTOG6_4	HBLK Toggle Position 6 for V-Sequence 4
A7	[11:0]	0	CLPOBTOG1_4	CLPOB Toggle Position 1 for V-Sequence 4
	[23:12]	0	CLPOBTOG2_4	CLPOB Toggle Position 2 for V-Sequence 4

Table XLII. V-Sequence 5 (VSEQ5) Register Map

Address	Data Bit Content	Default Value	Register Name	Description
A8	[1:0]	0	HBLKMASK_5	Masking Polarity during HBLK. H1 [0]. H3 [1].
	[2]	0	CLPOBPOL_5	CLPOB Start Polarity
	[3]	0	PBLKPOL_5	PBLK Start Polarity
	[7:4]	0	VPATSEL_5	Selected V-Pattern Group for V-Sequence 5
	[9:8]	0	VMASK_5	Enable Masking of V-Outputs (Specified by FREEZE/RESUME Registers)
	[11:10]	0	HBLKALT_5	Enable HBLK Alternation
	[23:12]	0	UNUSED	Unused
A9	[11:0]	0	VPATREPO_5	Number of Selected V-Pattern Group Repetitions for Odd Lines
	[23:12]	0	VPATREPE_5	Number of Selected V-Pattern Group Repetitions for Even Lines
AA	[11:0]	0	VPATSTART_5	Start Position in the Line for the Selected V-Pattern Group
	[23:12]	0	HDLEN_5	HD Line Length (Number of Pixels) for V-Sequence 5
AB	[11:0]	0	PBLKTOG1_5	PBLK Toggle Position 1 for V-Sequence 5
	[23:12]	0	PBLKTOG2_5	PBLK Toggle Position 2 for V-Sequence 5
AC	[11:0]	0	HBLKTOG1_5	HBLK Toggle Position 1 for V-Sequence 5
	[23:12]	0	HBLKTOG2_5	HBLK Toggle Position 2 for V-Sequence 5
AD	[11:0]	0	HBLKTOG3_5	HBLK Toggle Position 3 for V-Sequence 5
	[23:12]	0	HBLKTOG4_5	HBLK Toggle Position 4 for V-Sequence 5
AE	[11:0]	0	HBLKTOG5_5	HBLK Toggle Position 5 for V-Sequence 5
	[23:12]	0	HBLKTOG6_5	HBLK Toggle Position 6 for V-Sequence 5
AF	[11:0]	0	CLPOBTOG1_5	CLPOB Toggle Position 1 for V-Sequence 5
	[23:12]	0	CLPOBTOG2_5	CLPOB Toggle Position 2 for V-Sequence 5

Table XLIII. V-Sequence 6 (VSEQ6) Register Map

Address	Data Bit Content	Default Value	Register Name	Description
B0	[1:0]	0	HBLKMASK_6	Masking Polarity during HBLK. H1 [0]. H3 [1].
	[2]	0	CLPOBPOL_6	CLPOB Start Polarity
	[3]	0	PBLKPOL_6	PBLK Start Polarity
	[7:4]	0	VPATSEL_6	Selected V-Pattern Group for V-Sequence 6
	[9:8]	0	VMASK_6	Enable Masking of V-Outputs (Specified by FREEZE/RESUME Registers)
	[11:10]	0	HBLKALT_6	Enable HBLK Alternation
	[23:12]	0	UNUSED	Unused
B1	[11:0]	0	VPATREPO_6	Number of Selected V-Pattern Group Repetitions for Odd Lines
	[23:12]	0	VPATREPE_6	Number of Selected V-Pattern Group Repetitions for Even Lines
B2	[11:0]	0	VPATSTART_6	Start Position in the Line for the Selected V-Pattern Group
	[23:12]	0	HDLEN_6	HD Line Length (Number of Pixels) for V-Sequence 6
B3	[11:0]	0	PBLKTOG1_6	PBLK Toggle Position 1 for V-Sequence 6
	[23:12]	0	PBLKTOG2_6	PBLK Toggle Position 2 for V-Sequence 6
B4	[11:0]	0	HBLKTOG1_6	HBLK Toggle Position 1 for V-Sequence 6
	[23:12]	0	HBLKTOG2_6	HBLK Toggle Position 2 for V-Sequence 6
B5	[11:0]	0	HBLKTOG3_6	HBLK Toggle Position 3 for V-Sequence 6
	[23:12]	0	HBLKTOG4_6	HBLK Toggle Position 4 for V-Sequence 6
B6	[11:0]	0	HBLKTOG5_6	HBLK Toggle Position 5 for V-Sequence 6
	[23:12]	0	HBLKTOG6_6	HBLK Toggle Position 6 for V-Sequence 6
B7	[11:0]	0	CLPOBTOG1_6	CLPOB Toggle Position 1 for V-Sequence 6
	[23:12]	0	CLPOBTOG2_6	CLPOB Toggle Position 2 for V-Sequence 6

Table XLIV. V-Sequence 7 (VSEQ7) Register Map

Address	Data Bit Content	Default Value	Register Name	Description
B8	[1:0]	0	HBLKMASK_7	Masking Polarity during HBLK. H1 [0]. H3 [1].
	[2]	0	CLPOBPOL_7	CLPOB Start Polarity
	[3]	0	PBLKPOL_7	PBLK Start Polarity
	[7:4]	0	VPATSEL_7	Selected V-Pattern Group for V-Sequence 7
	[9:8]	0	VMASK_7	Enable Masking of V-Outputs (Specified by FREEZE/RESUME Registers)
	[11:10]	0	HBLKALT_7	Enable HBLK Alternation
	[23:12]	0	UNUSED	Unused
B9	[11:0]	0	VPATREPO_7	Number of Selected V-Pattern Group Repetitions for Odd Lines
	[23:12]	0	VPATREPE_7	Number of Selected V-Pattern Group Repetitions for Even Lines
BA	[11:0]	0	VPATSTART_7	Start Position in the Line for the Selected V-Pattern Group
	[23:12]	0	HDLEN_7	HD Line Length (Number of Pixels) for V-Sequence 7
BB	[11:0]	0	PBLKTOG1_7	PBLK Toggle Position 1 for V-Sequence 7
	[23:12]	0	PBLKTOG2_7	PBLK Toggle Position 2 for V-Sequence 7
BC	[11:0]	0	HBLKTOG1_7	HBLK Toggle Position 1 for V-Sequence 7
	[23:12]	0	HBLKTOG2_7	HBLK Toggle Position 2 for V-Sequence 7
BD	[11:0]	0	HBLKTOG3_7	HBLK Toggle Position 3 for V-Sequence 7
	[23:12]	0	HBLKTOG4_7	HBLK Toggle Position 4 for V-Sequence 7
BE	[11:0]	0	HBLKTOG5_7	HBLK Toggle Position 5 for V-Sequence 7
	[23:12]	0	HBLKTOG6_7	HBLK Toggle Position 6 for V-Sequence 7
BF	[11:0]	0	CLPOBTOG1_7	CLPOB Toggle Position 1 for V-Sequence 7
	[23:12]	0	CLPOBTOG2_7	CLPOB Toggle Position 2 for V-Sequence 7

Table XLV. V-Sequence 8 (VSEQ8) Register Map

Address	Data Bit Content	Default Value	Register Name	Description
C0	[1:0]	0	HBLKMASK_8	Masking Polarity during HBLK. H1 [0]. H3 [1].
	[2]	0	CLPOBPOL_8	CLPOB Start Polarity
	[3]	0	PBLKPOL_8	PBLK Start Polarity
	[7:4]	0	VPATSEL_8	Selected V-Pattern Group for V-Sequence 8
	[9:8]	0	VMASK_8	Enable Masking of V-Outputs (Specified by FREEZE/RESUME Registers)
	[11:10]	0	HBLKALT_8	Enable HBLK Alternation
	[23:12]	0	UNUSED	Unused
C1	[11:0]	0	VPATREPO_8	Number of Selected V-Pattern Group Repetitions for Odd Lines
	[23:12]	0	VPATREPE_8	Number of Selected V-Pattern Group Repetitions for Even Lines
C2	[11:0]	0	VPATSTART_8	Start Position in the Line for the Selected V-Pattern Group
	[23:12]	0	HDLEN_8	HD Line Length (Number of Pixels) for V-Sequence 8
C3	[11:0]	0	PBLKTOG1_8	PBLK Toggle Position 1 for V-Sequence 8
	[23:12]	0	PBLKTOG2_8	PBLK Toggle Position 2 for V-Sequence 8
C4	[11:0]	0	HBLKTOG1_8	HBLK Toggle Position 1 for V-Sequence 8
	[23:12]	0	HBLKTOG2_8	HBLK Toggle Position 2 for V-Sequence 8
C5	[11:0]	0	HBLKTOG3_8	HBLK Toggle Position 3 for V-Sequence 8
	[23:12]	0	HBLKTOG4_8	HBLK Toggle Position 4 for V-Sequence 8
C6	[11:0]	0	HBLKTOG5_8	HBLK Toggle Position 5 for V-Sequence 8
	[23:12]	0	HBLKTOG6_8	HBLK Toggle Position 6 for V-Sequence 8
C7	[11:0]	0	CLPOBTOG1_8	CLPOB Toggle Position 1 for V-Sequence 8
	[23:12]	0	CLPOBTOG2_8	CLPOB Toggle Position 2 for V-Sequence 8

Table XLVI. V-Sequence 9 (VSEQ9) Register Map

Address	Data Bit Content	Default Value	Register Name	Description
C8	[1:0]	0	HBLKMASK_9	Masking Polarity during HBLK. H1 [0]. H3 [1].
	[2]	0	CLPOBPOL_9	CLPOB Start Polarity
	[3]	0	PBLKPOL_9	PBLK Start Polarity
	[7:4]	0	VPATSEL_9	Selected V-Pattern Group for V-Sequence 9
	[9:8]	0	VMASK_9	Enable Masking of V-Outputs (Specified by FREEZE/RESUME Registers)
	[11:10]	0	HBLKALT_9	Enable HBLK Alternation
	[23:12]	0	UNUSED	Unused
C9	[11:0]	0	VPATREPO_9	Number of Selected V-Pattern Group Repetitions for Odd Lines
	[23:12]	0	VPATREPE_9	Number of Selected V-Pattern Group Repetitions for Even Lines
CA	[11:0]	0	VPATSTART_9	Start Position in the Line for the Selected V-Pattern Group
	[23:12]	0	HDLEN_9	HD Line Length (Number of Pixels) for V-Sequence 9
CB	[11:0]	0	PBLKTOG1_9	PBLK Toggle Position 1 for V-Sequence 9
	[23:12]	0	PBLKTOG2_9	PBLK Toggle Position 2 for V-Sequence 9
CC	[11:0]	0	HBLKTOG1_9	HBLK Toggle Position 1 for V-Sequence 9
	[23:12]	0	HBLKTOG2_9	HBLK Toggle Position 2 for V-Sequence 9
CD	[11:0]	0	HBLKTOG3_9	HBLK Toggle Position 3 for V-Sequence 9
	[23:12]	0	HBLKTOG4_9	HBLK Toggle Position 4 for V-Sequence 9
CE	[11:0]	0	HBLKTOG5_9	HBLK Toggle Position 5 for V-Sequence 9
	[23:12]	0	HBLKTOG6_9	HBLK Toggle Position 6 for V-Sequence 9
CF	[11:0]	0	CLPOBTOG1_9	CLPOB Toggle Position 1 for V-Sequence 9
	[23:12]	0	CLPOBTOG2_9	CLPOB Toggle Position 2 for V-Sequence 9

Table XLVII. Field 0 Register Map

Address	Data Bit Content	Default Value	Register Name	Description
D0	[3:0]	0	VSEQSEL0_0	Selected V-Sequence for Region 0.
	[4]	0	SWEEP0_0	Select Sweep Region for Region 0. 0 = No Sweep, 1 = Sweep.
	[5]	0	MULTI0_0	Select Multiplier Region for Region 0. 0 = No Multiplier, 1 = Multiplier.
	[9:6]	0	VSEQSEL1_0	Selected V-Sequence for Region 1.
	[10]	0	SWEEP1_0	Select Sweep Region for Region 1. 0 = No Sweep, 1 = Sweep.
	[11]	0	MULTI1_0	Select Multiplier Region for Region 1. 0 = No Multiplier, 1 = Multiplier.
	[15:12]	0	VSEQSEL2_0	Selected V-Sequence for Region 2.
	[16]	0	SWEEP2_0	Select Sweep Region for Region 2. 0 = No Sweep, 1 = Sweep.
	[17]	0	MULTI2_0	Select Multiplier Region for Region 2. 0 = No Multiplier, 1 = Multiplier.
	[21:18]	0	VSEQSEL3_0	Selected V-Sequence for Region 3.
	[22]	0	SWEEP3_0	Select Sweep Region for Region 3. 0 = No Sweep, 1 = Sweep.
	[23]	0	MULTI3_0	Select Multiplier Region for Region 3. 0 = No Multiplier, 1 = Multiplier.
	D1	[3:0]	0	VSEQSEL4_0
[4]		0	SWEEP4_0	Select Sweep Region for Region 4. 0 = No Sweep, 1 = Sweep.
[5]		0	MULTI4_0	Select Multiplier Region for Region 4. 0 = No Multiplier, 1 = Multiplier.
[9:6]		0	VSEQSEL5_0	Selected V-Sequence for Region 5.
[10]		0	SWEEP5_0	Select Sweep Region for Region 5. 0 = No Sweep, 1 = Sweep.
[11]		0	MULTI5_0	Select Multiplier Region for Region 5. 0 = No Multiplier, 1 = Multiplier.
[15:12]		0	VSEQSEL6_0	Selected V-Sequence for Region 6.
[16]		0	SWEEP6_0	Select Sweep Region for Region 6. 0 = No Sweep, 1 = Sweep.
[17]	0	MULTI6_0	Select Multiplier Region for Region 6. 0 = No Multiplier, 1 = Multiplier.	
[23:18]			UNUSED	Unused.
D2	[11:0]	0	SCP1_0	V-Sequence Change Position #1 for Field 0.
	[23:12]	0	SCP2_0	V-Sequence Change Position #2 for Field 0.
D3	[11:0]	0	SCP3_0	V-Sequence Change Position #3 for Field 0.
	[23:12]	0	SCP4_0	V-Sequence Change Position #4 for Field 0.
D4	[11:0]	0	VDLEN_0	VD Field Length (Number of Lines) for Field 0.
	[23:12]	0	HDLAST_0	HD Line Length (Number of Pixels) for Last Line in Field 0.

Table XLVII. Field 0 Register Map (continued)

Address	Data Bit Content	Default Value	Register Name	Description
D5	[3:0]	0	VPATSECONDD_0	Selected Second V-Pattern Group for VSG Active Line.
	[9:4]	0	SGMASK_0	Masking of VSG Outputs during VSG Active Line.
	[21:10]	0	SGPATSEL_0	Selection of VSG Patterns for Each VSG Output.
D6	[11:0]	0	SGLINE1_0	VSG Active Line 1.
	[23:12]	0	SGLINE2_0	VSG Active Line 2 (if no Second Line Needed, Set to Same as Line 1 or Max).
D7	[11:0]	0	SCP5_0	V-Sequence Change Position #5 for Field 0.
	[23:12]	0	SCP6_0	V-Sequence Change Position #6 for Field 0.

Table XLVIII. Field 1 Register Map

Address	Data Bit Content	Default Value	Register Name	Description
D8	[3:0]	0	VSEQSEL0_1	Selected V-Sequence for Region 0.
	[4]	0	SWEEP0_1	Select Sweep Region for Region 0. 0 = No Sweep, 1 = Sweep.
	[5]	0	MULTI0_1	Select Multiplier Region for Region 0. 0 = No Multiplier, 1 = Multiplier.
	[9:6]	0	VSEQSEL1_1	Selected V-Sequence for Region 1.
	[10]	0	SWEEP1_1	Select Sweep Region for Region 1. 0 = No Sweep, 1 = Sweep.
	[11]	0	MULTI1_1	Select Multiplier Region for Region 1. 0 = No Multiplier, 1 = Multiplier.
	[15:12]	0	VSEQSEL2_1	Selected V-Sequence for Region 2.
	[16]	0	SWEEP2_1	Select Sweep Region for Region 2. 0 = No Sweep, 1 = Sweep.
	[17]	0	MULTI2_1	Select Multiplier Region for Region 2. 0 = No Multiplier, 1 = Multiplier.
	[21:18]	0	VSEQSEL3_1	Selected V-Sequence for Region 3.
	[22]	0	SWEEP3_1	Select Sweep Region for Region 3. 0 = No Sweep, 1 = Sweep.
	[23]	0	MULTI3_1	Select Multiplier Region for Region 3. 0 = No Multiplier, 1 = Multiplier.
	D9	[3:0]	0	VSEQSEL4_1
[4]		0	SWEEP4_1	Select Sweep Region for Region 4. 0 = No Sweep, 1 = Sweep.
[5]		0	MULTI4_1	Select Multiplier Region for Region 4. 0 = No Multiplier, 1 = Multiplier.
[9:6]		0	VSEQSEL5_1	Selected V-Sequence for Region 5.
[10]		0	SWEEP5_1	Select Sweep Region for Region 5. 0 = No Sweep, 1 = Sweep.
[11]		0	MULTI5_1	Select Multiplier Region for Region 5. 0 = No Multiplier, 1 = Multiplier.
[15:12]		0	VSEQSEL6_1	Selected V-Sequence for Region 6.
[16]		0	SWEEP6_1	Select Sweep Region for Region 6. 0 = No Sweep, 1 = Sweep.
[17]		0	MULTI6_1	Select Multiplier Region for Region 6. 0 = No Multiplier, 1 = Multiplier.
[23:18]			UNUSED	Unused.
DA	[11:0]	0	SCP1_1	V-Sequence Change Position #1 for Field 1.
	[23:12]	0	SCP2_1	V-Sequence Change Position #2 for Field 1.
DB	[11:0]	0	SCP3_1	V-Sequence Change Position #3 for Field 1.
	[23:12]	0	SCP4_1	V-Sequence Change Position #4 for Field 1.
DC	[11:0]	0	VDLEN_1	VD Field Length (Number of Lines) for Field 1.
	[23:12]	0	HDLAST_1	HD Line Length (Number of Pixels) for Last Line in Field 1.
DD	[3:0]	0	VPATSECONDD_1	Selected Second V-Pattern Group for VSG Active Line.
	[9:4]	0	SGMASK_1	Masking of VSG Outputs during VSG Active Line.
	[21:10]	0	SGPATSEL_1	Selection of VSG Patterns for Each VSG Output.
DE	[11:0]	0	SGLINE1_1	VSG Active Line 1.
	[23:12]	0	SGLINE2_1	VSG Active Line 2 (if no Second Line Needed, Set to Same as Line 1 or Max).
DF	[11:0]	0	SCP5_1	V-Sequence Change Position #5 for Field 1.
	[23:12]	0	SCP6_1	V-Sequence Change Position #6 for Field 1.

Table XLIX. Field 2 Register Map

Address	Data Bit Content	Default Value	Register Name	Description
E0	[3:0]	0	VSEQSEL_2	Selected V-Sequence for Region 0.
	[4]	0	SWEEP0_2	Select Sweep Region for Region 0. 0 = No Sweep, 1 = Sweep.
	[5]	0	MULTI0_2	Select Multiplier Region for Region 0. 0 = No Multiplier, 1 = Multiplier.
	[9:6]	0	VSEQSEL1_2	Selected V-Sequence for Region 1.
	[10]	0	SWEEP1_2	Select Sweep Region for Region 1. 0 = No Sweep, 1 = Sweep.
	[11]	0	MULTI1_2	Select Multiplier Region for Region 1. 0 = No Multiplier, 1 = Multiplier.
	[15:12]	0	VSEQSEL2_2	Selected V-Sequence for Region 2.
	[16]	0	SWEEP2_2	Select Sweep Region for Region 2. 0 = No Sweep, 1 = Sweep.
	[17]	0	MULTI2_2	Select Multiplier Region for Region 2. 0 = No Multiplier, 1 = Multiplier.
	[21:18]	0	VSEQSEL3_2	Selected V-Sequence for Region 3.
E1	[22]	0	SWEEP3_2	Select Sweep Region for Region 3. 0 = No Sweep, 1 = Sweep
	[23]	0	MULTI3_2	Select Multiplier Region for Region 3. 0 = No Multiplier, 1 = Multiplier.
	[3:0]	0	VSEQSEL4_2	Selected V-Sequence for Region 4.
	[4]	0	SWEEP4_2	Select Sweep Region for Region 4. 0 = No Sweep, 1 = Sweep.
	[5]	0	MULTI4_2	Select Multiplier Region for Region 4. 0 = No Multiplier, 1 = Multiplier.
	[9:6]	0	VSEQSEL5_2	Selected V-Sequence for Region 5.
	[10]	0	SWEEP5_2	Select Sweep Region for Region 5. 0 = No Sweep, 1 = Sweep.
	[11]	0	MULTI5_2	Select Multiplier Region for Region 5. 0 = No Multiplier, 1 = Multiplier.
E2	[15:12]	0	VSEQSEL6_2	Selected V-Sequence for Region 6.
	[16]	0	SWEEP6_2	Select Sweep Region for Region 6. 0 = No Sweep, 1 = Sweep.
	[17]	0	MULTI6_2	Select Multiplier Region for Region 6. 0 = No Multiplier, 1 = Multiplier.
	[23:18]		UNUSED	Unused.
	[11:0]	0	SCP1_2	V-Sequence Change Position #1 for Field 2.
E3	[23:12]	0	SCP2_2	V-Sequence Change Position #2 for Field 2.
	[11:0]	0	SCP3_2	V-Sequence Change Position #3 for Field 2.
E4	[23:12]	0	SCP4_2	V-Sequence Change Position #4 for Field 2.
	[11:0]	0	VDLEN0_2	VD Field Length (Number of Lines) for Field 2.
E5	[23:12]	0	HDLAST_2	HD Line Length (Number of Pixels) for Last Line in Field 2.
	[3:0]	0	VPATSECOND_2	Selected Second V-Pattern Group for VSG Active Line.
	[9:4]	0	SGMASK_2	Masking of VSG Outputs during VSG Active Line.
E6	[21:10]	0	SGPATSEL_2	Selection of VSG Patterns for Each VSG Output.
	[11:0]	0	SGLINE1_2	VSG Active Line 1.
E7	[23:12]	0	SGLINE2_2	VSG Active Line 2 (if no Second Line Needed, Set to Same as Line 1 or Max).
	[11:0]	0	SCP5_2	V-Sequence Change Position #5 for Field 2.
	[23:12]	0	SCP6_2	V-Sequence Change Position #6 for Field 2.

Table L. Field 3 Register Map

Address	Data Bit Content	Default Value	Register Name	Description
E8	[3:0]	0	VSEQSEL_3	Selected V-Sequence for Region 0.
	[4]	0	SWEEP0_3	Select Sweep Region for Region 0. 0 = No Sweep, 1 = Sweep.
	[5]	0	MULTI0_3	Select Multiplier Region for Region 0. 0 = No Multiplier, 1 = Multiplier.
	[9:6]	0	VSEQSEL1_3	Selected V-Sequence for Region 1.
	[10]	0	SWEEP1_3	Select Sweep Region for Region 1. 0 = No Sweep, 1 = Sweep.
	[11]	0	MULTI1_3	Select Multiplier Region for Region 1. 0 = No Multiplier, 1 = Multiplier.
	[15:12]	0	VSEQSEL2_3	Selected V-Sequence for Region 2.
	[16]	0	SWEEP2_3	Select Sweep Region for Region 2. 0 = No Sweep, 1 = Sweep.
	[17]	0	MULTI2_3	Select Multiplier Region for Region 2. 0 = No Multiplier, 1 = Multiplier.
	[21:18]	0	VSEQSEL3_3	Selected V-Sequence for Region 3.
	[22]	0	SWEEP3_3	Select Sweep Region for Region 3. 0 = No Sweep, 1 = Sweep.
	[23]	0	MULTI3_3	Select Multiplier Region for Region 3. 0 = No Multiplier, 1 = Multiplier.

Table L. Field 3 Register Map (continued)

Address	Data Bit Content	Default Value	Register Name	Description
E9	[3:0]	0	VSEQSEL4_3	Selected V-Sequence for Region 4.
	[4]	0	SWEEP4_3	Select Sweep Region for Region 4. 0 = No Sweep, 1 = Sweep.
	[5]	0	MULTI4_3	Select Multiplier Region for Region 4. 0 = No Multiplier, 1 = Multiplier.
	[9:6]	0	VSEQSEL5_3	Selected V-Sequence for Region 5.
	[10]	0	SWEEP5_3	Select Sweep Region for Region 5. 0 = No Sweep, 1 = Sweep.
	[11]	0	MULTI5_3	Select Multiplier Region for Region 5. 0 = No Multiplier, 1 = Multiplier.
	[15:12]	0	VSEQSEL6_3	Selected V-Sequence for Region 6.
	[16]	0	SWEEP6_3	Select Sweep Region for Region 6. 0 = No Sweep, 1 = Sweep.
	[17]	0	MULTI6_3	Select Multiplier Region for Region 6. 0 = No Multiplier, 1 = Multiplier.
	[23:18]		UNUSED	Unused.
EA	[11:0]	0	SCP1_3	V-Sequence Change Position #1 for Field 3.
	[23:12]	0	SCP2_3	V-Sequence Change Position #2 for Field 3.
EB [23:12]	[11:0]	0	SCP3_3	V-Sequence Change Position #3 for Field 3.
		0	SCP4_3	V-Sequence Change Position #4 for Field 3.
EC	[11:0]	0	VDLEN_3	VD Field Length (Number of Lines) for Field 3.
	[23:12]	0	HDLAST_3	HD Line Length (Number of Pixels) for Last Line in Field 3.
ED	[3:0]	0	VPATSECOND_3	Selected Second V-Pattern Group for VSG Active Line.
	[9:4]	0	SGMASK_3	Masking of VSG Outputs during VSG Active Line.
	[21:10]	0	SGPATSEL_3	Selection of VSG Patterns for Each VSG Output.
EE	[11:0]	0	SGLINE1_3	VSG Active Line 1.
	[23:12]	0	SGLINE2_3	VSG Active Line 2 (if no Second Line Needed, Set to Same as Line 1 or Max).
EF	[11:0]	0	SCP5_3	V-Sequence Change Position #5 for Field 3.
	[23:12]	0	SCP6_3	V-Sequence Change Position #6 for Field 3.

Table LI. Field 4 Register Map

Address	Data Bit Content	Default Value	Register Name	Description
F0	[3:0]	0	VSEQSEL0_4	Selected V-Sequence for Region 0.
	[4]	0	SWEEP0_4	Select Sweep Region for Region 0. 0 = No Sweep, 1 = Sweep.
	[5]	0	MULTI0_4	Select Multiplier Region for Region 0. 0 = No Multiplier, 1 = Multiplier.
	[9:6]	0	VSEQSEL1_4	Selected V-Sequence for Region 1.
	[10]	0	SWEEP1_4	Select Sweep Region for Region 1. 0 = No Sweep, 1 = Sweep.
	[11]	0	MULTI1_4	Select Multiplier Region for Region 1. 0 = No Multiplier, 1 = Multiplier.
	[15:12]	0	VSEQSEL2_4	Selected V-Sequence for Region 2.
	[16]	0	SWEEP2_4	Select Sweep Region for Region 2. 0 = No Sweep, 1 = Sweep.
	[17]	0	MULTI2_4	Select Multiplier Region for Region 2. 0 = No Multiplier, 1 = Multiplier.
	[21:18]	0	VSEQSEL3_4	Selected V-Sequence for Region 3.
	[22]	0	SWEEP3_4	Select Sweep Region for Region 3. 0 = No Sweep, 1 = Sweep.
	[23]	0	MULTI3_4	Select Multiplier Region for Region 3. 0 = No Multiplier, 1 = Multiplier.
	F1	[3:0]	0	VSEQSEL4_4
[4]		0	SWEEP4_4	Select Sweep Region for Region 4. 0 = No Sweep, 1 = Sweep.
[5]		0	MULTI4_4	Select Multiplier Region for Region 4. 0 = No Multiplier, 1 = Multiplier.
[9:6]		0	VSEQSEL5_4	Selected V-Sequence for Region 5.
[10]		0	SWEEP5_4	Select Sweep Region for Region 5. 0 = No Sweep, 1 = Sweep.
[11]		0	MULTI5_4	Select Multiplier Region for Region 5. 0 = No Multiplier, 1 = Multiplier..
[15:12]		0	VSEQSEL6_4	Selected V-Sequence for Region 6.
[16]		0	SWEEP6_4	Select Sweep Region for Region 6. 0 = No Sweep, 1 = Sweep.
[17]		0	MULTI6_4	Select Multiplier Region for Region 6. 0 = No Multiplier, 1 = Multiplier.
[23:18]			UNUSED	Unused.
F2	[11:0]	0	SCP1_4	V-Sequence Change Position #1 for Field 4.
	[23:12]	0	SCP2_4	V-Sequence Change Position #2 for Field 4.
F3	[11:0]	0	SCP3_4	V-Sequence Change Position #3 for Field 4.
	[23:12]	0	SCP4_4	V-Sequence Change Position #4 for Field 4.

Table LI. Field 4 Register Map (continued)

Address	Data Bit Content	Default Value	Register Name	Description
F4	[11:0]	0	VDLEN_4	VD Field Length (Number of Lines) for Field 4.
	[23:12]	0	HDLAST_4	HD Line Length (Number of Pixels) for Last Line in Field 4.
F5	[3:0]	0	VPATSECOND_4	Selected Second V-Pattern Group for VSG Active Line.
	[9:4]	0	SGMASK_4	Masking of VSG Outputs during VSG Active Line.
	[21:10]	0	SGPATSEL_4	Selection of VSG Patterns for Each VSG Output.
F6	[11:0]	0	SGLINE1_4	VSG Active Line 1.
	[23:12]	0	SGLINE2_4	VSG Active Line 2 (if no Second Line Needed, Set to Same as Line 1 or Max).
F7	[11:0]	0	SCP5_4	V-Sequence Change Position #5 for Field 4.
	[23:12]	0	SCP6_4	V-Sequence Change Position #6 for Field 4.

Table LII. Field 5 Register Map

Address	Data Bit Content	Default Value	Register Name	Description
F8	[3:0]	0	VSEQSEL0_5	Selected V-Sequence for Region 0.
	[4]	0	SWEEP0_5	Select Sweep Region for Region 0. 0 = No Sweep, 1 = Sweep.
	[5]	0	MULTI0_5	Select Multiplier Region for Region 0. 0 = No Multiplier, 1 = Multiplier.
	[9:6]	0	VSEQSEL1_5	Selected V-Sequence for Region 1.
	[10]	0	SWEEP1_5	Select Sweep Region for Region 1. 0 = No Sweep, 1 = Sweep.
	[11]	0	MULTI1_5	Select Multiplier Region for Region 1. 0 = No Multiplier, 1 = Multiplier.
	[15:12]	0	VSEQSEL2_5	Selected V-Sequence for Region 2.
	[16]	0	SWEEP2_5	Select Sweep Region for Region 2. 0 = No Sweep, 1 = Sweep.
	[17]	0	MULTI2_5	Select Multiplier Region for Region 2. 0 = No Multiplier, 1 = Multiplier.
	[21:18]	0	VSEQSEL3_5	Selected V-Sequence for Region 3.
	[22]	0	SWEEP3_5	Select Sweep Region for Region 3. 0 = No Sweep, 1 = Sweep.
	[23]	0	MULTI3_5	Select Multiplier Region for Region 3. 0 = No Multiplier, 1 = Multiplier.
	F9	[3:0]	0	VSEQSEL4_5
[4]		0	SWEEP4_5	Select Sweep Region for Region 4. 0 = No Sweep, 1 = Sweep
[5]		0	MULTI4_5	Select Multiplier Region for Region 4. 0 = No Multiplier, 1 = Multiplier.
[9:6]		0	VSEQSEL5_5	Selected V-Sequence for Region 5.
[10]		0	SWEEP5_5	Select Sweep Region for Region 5. 0 = No Sweep, 1 = Sweep.
[11]		0	MULTI5_5	Select Multiplier Region for Region 5. 0 =No Multiplier, 1 = Multiplier.
[15:12]		0	VSEQSEL6_5	Selected V-Sequence for Region 6.
[16]		0	SWEEP6_5	Select Sweep Region for Region 6. 0 = No Sweep, 1 = Sweep.
[17]		0	MULTI6_5	Select Multiplier Region for Region 6. 0 = No Multiplier, 1 = Multiplier.
[23:18]		UNUSED	Unused.	
FA	[11:0]	0	SCP1_5	V-Sequence Change Position #1 for Field 5.
	[23:12]	0	SCP2_5	V-Sequence Change Position #2 for Field 5.
FB	[11:0]	0	SCP3_5	V-Sequence Change Position #3 for Field 5.
	[23:12]	0	SCP4_5	V-Sequence Change Position #4 for Field 5.
FC	[11:0]	0	VDLEN_5	VD Field Length (Number of Lines) for Field 5.
	[23:12]	0	HDLAST_5	HD Line Length (Number of Pixels) for Last Line in Field 5.
FD	[3:0]	0	VPATSECOND_5	Selected Second V-Pattern Group for VSG Active Line.
	[9:4]	0	SGMASK_5	Masking of VSG Outputs during VSG Active Line.
	[21:10]	0	SGPATSEL_5	Selection of VSG Patterns for Each VSG Output.
FE	[11:0]	0	SGLINE1_5	VSG Active Line 1.
	[23:12]	0	SGLINE2_5	VSG Active Line 2 (if no Second Line Needed, Set to Same as Line 1 or Max).
FF	[11:0]	0	SCP5_5	V-Sequence Change Position #5 for Field 5.
	[23:12]	0	SCP6_5	V-Sequence Change Position #6 for Field 5.

OUTLINE DIMENSIONS

56-Lead Lead Frame Chip Scale Package [LFCSP]
 8 mm × 8 mm Body
 (CP-56)

Dimensions shown in millimeters

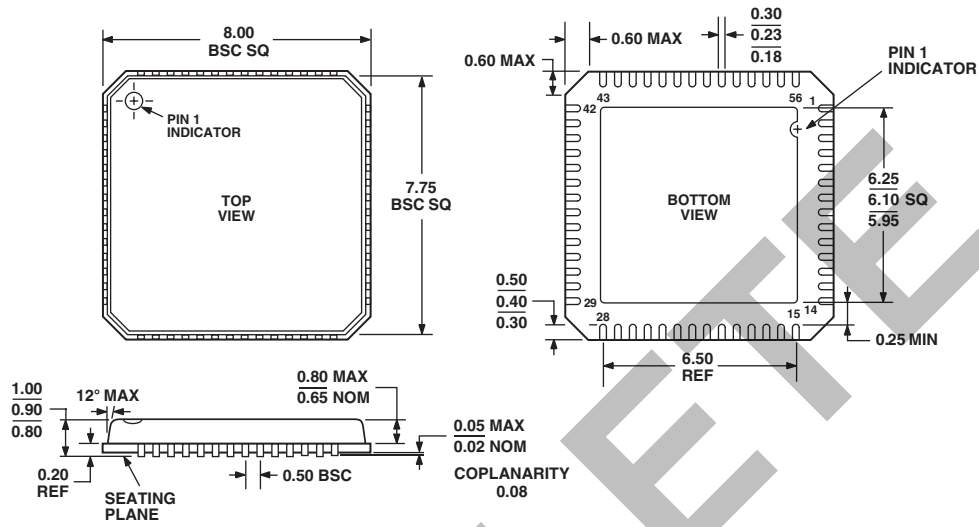

COMPLIANT TO JEDEC STANDARDS MO-220-VLLD-2

OBSOLETE

OBSOLETE